

FGMS12SR6020*A

Data Sheet

3-14.4Vdc Input, 20A, 0.6-5.5Vdc Output

The **Tomodachi** Series of non-isolated dc-dc converters deliver exceptional electrical and thermal performance in DOSA based footprints for Point-of-Load converters. Operating from a 3.0Vdc-14.4Vdc input, these are the converters of choice for Intermediate Bus Architecture (IBA) and Distributed Power Architecture applications that require high efficiency, tight regulation, and high reliability in elevated temperature environments with low airflow. The Tunable Loop™ feature allows the user to optimize the dynamic response of the converter to match the load with reduced amount of output capacitance leading to savings on cost and PWB area.

The **FGMS12SR6020*A** converter of the **Tomodachi** Series delivers 20A of output current at a tightly regulated programmable output voltage of 0.6Vdc to 5.5Vdc. The thermal performance of the **FGMS12SR6020*A** is best-in-class: Little derating is needed up to 85°C, under natural convection.

Applications

- Intermediate Bus Architecture
- Telecommunications
- Data/Voice processing
- Distributed Power Architecture
- Computing (Servers, Workstations)
- Test Equipments

**TUNABLE
LOOP™**
A LINEAGE POWER TRADEMARK



Features

- Compliant to RoHS EU Directive 2011/65/EU
- Delivers up to 20A (110W)
- High efficiency, no heatsink required
- Negative and Positive ON/OFF logic
- DOSA based
- Small size: 20.32 x 11.43 x 8.5mm (0.8 in x 0.45 in x 0.335 in)
- Tape & reel packaging
- Programmable output voltage from 0.6V to 5.5V via external resistor
- Tunable Loop™ to optimize dynamic output voltage response
- Flexible output voltage sequencing EZ-SEQUENCE
- Power Good signal
- Fixed switching frequency with capability of external synchronization
- Output over-current protection (non-latching)
- Over temperature protection
- Remote ON/OFF
- Ability to sink and source current
- No minimum load required
- Start up into pre-biased output
- UL* 60950-1 2nd Ed. Recognized, CSA† C22.2 No. 60950-1-07 Certified, and VDE‡ (EN60950-1 2nd Ed.) Licensed (Pending)
- ISO** 9001 and ISO 14001 certified manufacturing facilities

* UL is a registered trademark of Underwriters Laboratories, Inc.

† CSA is a registered trademark of Canadian Standards Association.

‡ VDE is a trademark of Verband Deutscher Elektrotechniker e.V.

** ISO is a registered trademark of the International Organization of Standards

FGMS12SR6020*A

Data Sheet

3-14.4Vdc Input, 20A, 0.6-5.5Vdc Output

Absolute Maximum Ratings

Stresses in excess of the absolute maximum ratings may lead to degradation in performance and reliability of the converter and may result in permanent damage.

PARAMETER	NOTES	MIN	TYP	MAX	UNITS
ABSOLUTE MAXIMUM RATINGS¹					
Input Voltage	Continuous	-0.3		15	Vdc
SEQ, SYNC, VS+				7	Vdc
Operating Temperature	Ambient temperature	-40		85	°C
Storage Temperature		-55		125	°C
Output Voltage		0.6		5.5	Vdc

Electrical Specifications

PARAMETER	NOTES	MIN	TYP	MAX	UNITS
INPUT CHARACTERISTICS					
Operating Input Voltage Range		3.0		14.4	Vdc
Maximum Input Current	Vin=4.5V to 14V, Io=Max			19	Adc
Input No Load Current, Vin=12V	Vout=5.0V		134		mA
	Vout=0.6V		69		mA
Input Stand-by Current	Vin=12V, module disabled		16.4		mA
Inrush Transient, I ² t				1	A ² s
Input Reflected-Ripple Current	Peak-to-peak (5Hz to 20MHz, 1uH source impedance; Vin=0 to 14V, Io=20A)		50		mAp-p
Input Ripple Rejection (120Hz)			-64		dB

All specifications apply over specified input voltage, output load, and temperature range, unless otherwise noted.

FGMS12SR6020*A
Data Sheet

3-14.4Vdc Input, 20A, 0.6-5.5Vdc Output

Electrical Specifications (Continued)

PARAMETER	NOTES	MIN	TYP	MAX	UNITS
OUTPUT CHARACTERISTICS					
Output Voltage Set Point (no load)	With 0.1% tolerance for external resistor used to set output voltage	-1.0		+1.0	%Vout
Output Voltage Range	(Over all operating input voltage, resistive load and temperature conditions until end of life)	-3.0		+3.0	%Vout
Adjustment Range (selected by an external resistor)	Some output voltages may not be possible depending on the input voltage – see feature description section	0.6		5.5	Vdc
Remote Sense Range				0.5	Vdc
Output Regulation (for $V_o \geq 2.5Vdc$)	Line ($V_{in} = \text{min to max}$)			0.4	%Vout
	Load ($I_o = \text{min to max}$)			10	mV
Output Regulation (for $V_o < 2.5Vdc$)	Line ($V_{in} = \text{min to max}$)			5	mV
	Load ($I_o = \text{min to max}$)			10	mV
	Temperature ($T_a = \text{min to max}$)			0.4	%Vout
Output Ripple and Noise	$V_{in}=12V$, $I_o = \text{min to max}$, $C_o = 0.1\mu F + 22\mu F$ ceramic capacitors				
Peak to Peak	5MHz to 20MHz bandwidth		50	100	mVp-p
RMS	5MHz to 20MHz bandwidth		20	38	mVrms
External Load Capacitance	Plus full load (resistive)				%
Without the Tunable Loop	$ESR \geq 1m\Omega$	2x47		2x47	μF
With the Tunable Loop	$ESR \geq 0.15m\Omega$	2x47		1,000	μF
	$ESR \geq 10m\Omega$	2x47		10,000	μF
Output Current Range	(in either sink or source mode)	0		20	Adc
Output Current Limit Inception (Hiccup mode)	Current limit does not operate in sink mode		130		% $I_o\text{-max}$
Output Short-Circuit Current	$V_o \leq 250mV$, Hiccup mode		1.4		Arms
Efficiency					
$V_{in} = 12Vdc$, $T_a = 25^\circ C$, $I_o = \text{max}$	$V_{out}=5.0Vdc$		95.2		%
	$V_{out}=3.3Vdc$		93.8		%
	$V_{out}=2.5Vdc$		92.6		%
	$V_{out}=1.8Vdc$		90.4		%
	$V_{out}=1.2Vdc$		87.1		%
	$V_{out}=0.6Vdc$		79.2		%

FGMS12SR6020*A
Data Sheet

3-14.4Vdc Input, 20A, 0.6-5.5Vdc Output

Electrical Specifications (Continued)

PARAMETER	NOTES	MIN	TYP	MAX	UNITS
Switching Frequency			500		kHz
Frequency Synchronization					
Synchronization Frequency Range		425		600	kHz
High Level Input Voltage		2.0			V
Low Level Input Voltage				0.4	V
Input Current, SYNC				100	nA
Minimum Pulse Width, SYNC		100			nS
Maximum SYNC rise time		100			nS

General Specifications

PARAMETER	NOTES	MIN	TYP	MAX	UNITS
Calculated MTBF	$I_o = 0.8 I_{o-max}$, $T_a = 40^\circ\text{C}$ Telecordia Issue 2 Method 1 Case 3		15,455,614		Hours
Weight			4.54(0.16)		g (oz.)

Feature Specifications

PARAMETER	NOTES	MIN	TYP	MAX	UNITS
ON/OFF Signal Interface	$V_{in} = \text{min to max}$, open collector or equivalent, Signal reference to GND				
Positive Logic					
Logic High (Module ON)					
Input High Current				1	mA
Input High Voltage		2		V_{in-max}	V
Logic Low (Module OFF)					
Input Low Current				1	mA
Input Low Voltage		-0.2		0.6	V
Negative Logic	On/Off pin is open collector/drain logic input with external pull-up resistor; signal reference to GND				
Logic High (Module OFF)					
Input High Current				1	mA
Input High Voltage		2		V_{in-max}	V
Logic Low (Module ON)					
Input Low Current				10	uA
Input Low Voltage		-0.2		0.6	V

FGMS12SR6020*A

Data Sheet

3-14.4Vdc Input, 20A, 0.6-5.5Vdc Output

Feature Specifications (Continued)

PARAMETER	NOTES	MIN	TYP	MAX	UNITS
Turn-On Delay Time	Full resistive load				
with Vin (module enabled, then Vin applied)	From Vin=Vin(min) to 0.1*Vout(nom)		1.2		ms
with Enable (Vin applied, then enabled)	From enable to 0.1*Vout(nom)		0.8		ms
Rise Time (Full resistive load)	From 0.1*Vout(nom) to 0.9*Vout(nom)		2.7		ms
Output Voltage Overshoot	Ta = 25C, Vin = min to max, Iout = min to max, with or without external capacitance			3.0	%Vout
Over Temperature Protection (See Thermal Considerations section)				120	°C
Tracking Accuracy	(Power-Up: 0.5V/ms)			100	mV
	(Power-Down: 0.5V/ms)			100	mV
Input Under Voltage Lockout					
Turn-on Threshold				3.25	Vdc
Turn-off Threshold		2.6			Vdc
Hysteresis			0.25		Vdc
Resolution of Adjustable Input Under Voltage Threshold				500	mV
Power Good					
Overvoltage threshold for PGOOD ON			108		%Vout
Overvoltage threshold for PGOOD OFF			110		%Vout
Undervoltage threshold for PGOOD ON			92		%Vout
Undervoltage threshold for PGOOD OFF			90		%Vout
Pull-down resistance of PGOOD pin				50	Ω
Sink current capability into PGOOD pin				5	mA

* Over temperature Warning – Warning may not activate before alarm and unit may shutdown before warning

FGMS12SR6020*A

Data Sheet

3-14.4Vdc Input, 20A, 0.6-5.5Vdc Output

Design Considerations

Input Filtering

The **FGMS12SR6020*A** converter should be connected to a low ac-impedance source. A highly inductive source can affect the stability of the module. An input capacitance must be placed directly adjacent to the input pin of the module, to minimize input ripple voltage and ensure module stability.

To minimize input voltage ripple, ceramic capacitors are recommended at the input of the module. Fig-1 shows the input ripple voltage for various output voltages at 20A of load current with 2x22uF or 3x22uF ceramic capacitors and an input of 12V.

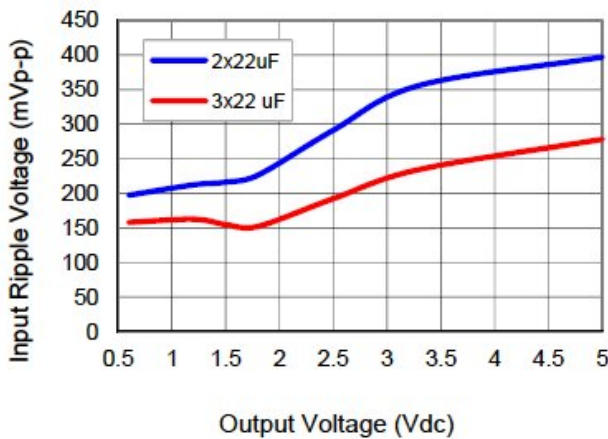

Fig-1: Input ripple voltage for various output voltages with 2x22uF or 3x22uF ceramic capacitors at the input (20A load). Input voltage is 12V.

Output Filtering

The **FGMS12SR6020*A** is designed for low output ripple voltage and will meet the maximum output ripple specification with 0.1uF ceramic and 2x47uF ceramic capacitors at the output of the module. However, additional output filtering may be required by the system designer for a number of reasons. First, there may be a need to further reduce the output ripple and noise of the module. Second, the dynamic response characteristics may need to be customized to a particular load step change.

To reduce the output ripple and improve the dynamic response to a step load change, additional capacitance at the output can be used. Low ESR polymer and ceramic capacitors are recommended to improve the dynamic response of the module. Fig-2 provides output ripple information for different

external capacitance values at various Vo and a full load current of 20A. For stable operation of the module, limit the capacitance to less than the maximum output capacitance as specified in the electrical specification table. Optimal performance of the module can be achieved by using the Tunable Loop™ feature described later in this data sheet.

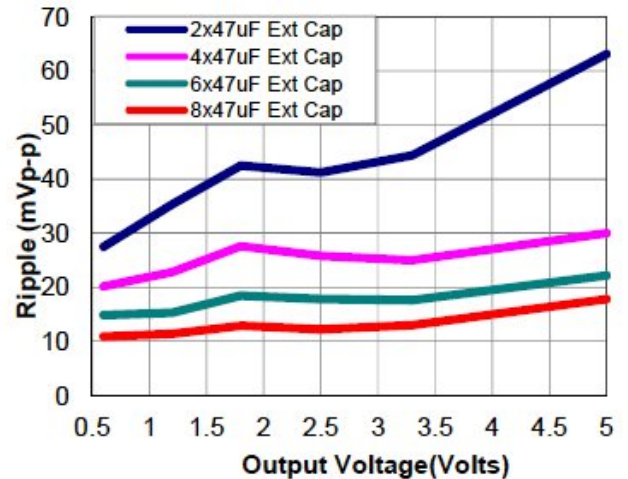

Fig-2: Output ripple voltage for various output voltages with external 2x47uF, 4x47uF, 6x47uF or 8x47uF ceramic capacitors at the output (20A load). Input voltage is 12V.

Safety Consideration

For safety agency approval the power module must be installed in compliance with the spacing and separation requirements of the end-use safety agency standards, i.e., UL 60950-1 2nd, CSA C22.2 No. 60950-1-07, DIN EN 60950-1:2006 + A11 (VDE0805 Teil 1 + A11):2009-11; EN 60950-1:2006 + A11:2009-03.

For the converter output to be considered meeting the requirements of safety extra-low voltage (SELV), the input must meet SELV requirements. The power module has extra-low voltage (ELV) outputs when all inputs are ELV.

The **Tomodachi** series were tested using an external Littelfuse 456 series fast-acting fuse rated at 30A, 100 Vdc in the ungrounded input.

FGMS12SR6020*A

3-14.4Vdc Input, 20A, 0.6-5.5Vdc Output

Data Sheet

Feature Descriptions

Remote On/Off

The **FGMS12SR6020*A** power modules feature an On/Off pin for remote On/Off operation. Two On/Off logic options are available. In the Positive Logic On/Off option, (device code suffix "P" - see Ordering Information), the module turns ON during a logic High on the On/Off pin and turns OFF during a logic Low. With the Negative Logic On/Off option, (device code suffix "N" - see Ordering Information), the module turns OFF during logic High and ON during logic Low. The On/Off signal should be always referenced to ground. For either On/Off logic option, leaving the On/Off pin disconnected will turn the module ON when input voltage is present.

For positive logic modules, the circuit configuration for using the On/Off pin is shown in Fig-3. When the external transistor Q2 is in the OFF state, the internal transistor Q7 is turned ON, which turn Q3 OFF, which keeps Q6 OFF and Q5 OFF. This allows the internal PWM #Enable signal to be pulled up by the internal 3.3V, thus turning the module ON. When transistor Q2 is turned ON, the On/Off pin is pulled low, which turns Q7 OFF which turns Q3, Q6 and Q5 ON and the internal PWM #Enable signal is pulled low and the module is OFF. A suggested value for Rpullup is 20kΩ.

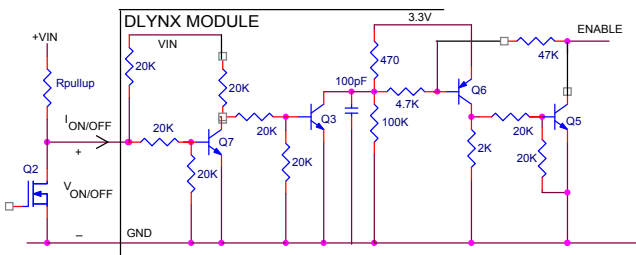

Fig-3: Circuit configuration for using positive On/Off logic.

For negative logic On/Off modules, the circuit configuration is shown in Fig-4. The On/Off pin should be pulled high with an external pull-up resistor (suggested value for the 3V to 14V input range is 20Kohms). When transistor Q2 is in the OFF state, the On/Off pin is pulled high, transistor Q3 is turned ON. This turns Q6 ON, followed by Q5 turning ON which pulls the internal ENABLE low and the module is OFF. To turn the module ON, Q2 is turned ON pulling the On/Off pin low, turning transistor Q3 OFF, which keeps Q6 and Q5 OFF resulting in the PWM Enable pin going high.

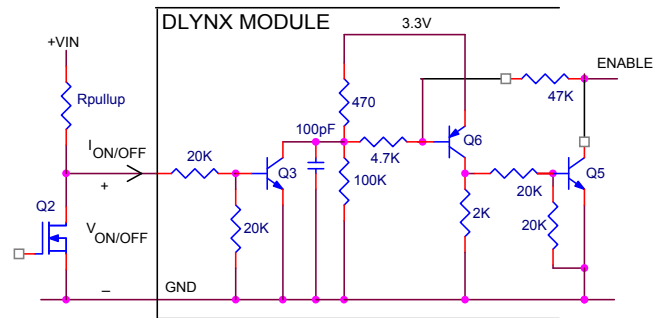

Fig-4: Circuit configuration for using negative On/Off logic.

Monotonic Start-up and Shut-down

The module has monotonic start-up and shutdown behavior for any combination of rated input voltage, output current and operating temperature range.

Startup into Pre-biased Output

The module can start into a prebiased output as long as the prebias voltage is 0.5V less than the set output voltage.

FGMS12SR6020*A

Data Sheet

3-14.4Vdc Input, 20A, 0.6-5.5Vdc Output

Output Voltage Programming

The output voltage of the module is programmable to any voltage from 0.6Vdc to 5.5Vdc by connecting a resistor between the Trim and SIG_GND pins of the module. Certain restrictions apply on the output voltage set point depending on the input voltage. These are shown in the Output Voltage vs. Input Voltage Set Point Area plot in Fig-5. The Upper Limit curve shows that for output voltages lower than 1V, the input voltage must be lower than the maximum of 14.4V. The Lower Limit curve shows that for output voltages higher than 0.6V, the input voltage needs to be larger than the minimum of 3V.

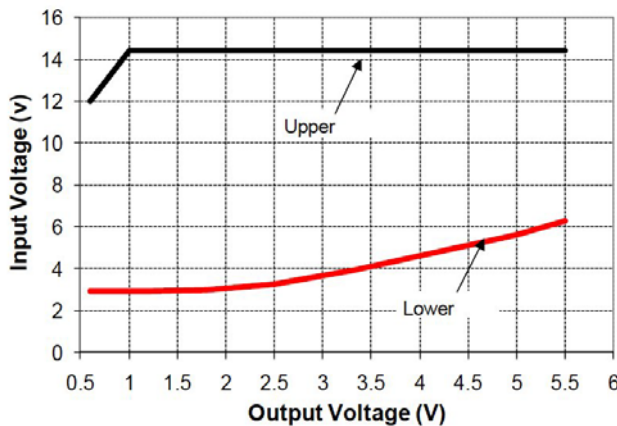
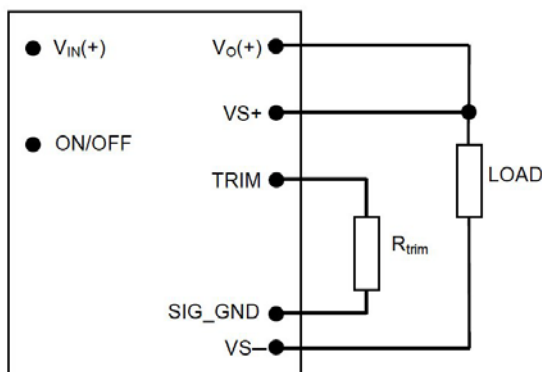

Fig-5: Output Voltage vs. Input Voltage Set Point Area plot showing limits where the output voltage can be set for different input voltages.



Caution – Do not connect SIG_GND to GND elsewhere in the layout.

Fig-6: Output Voltage vs. Input Voltage Set Point Area plot showing limits where the output voltage can be set for different input voltages.

Without an external resistor between Trim and SIG_GND pins, the output of the module will be 0.6Vdc. To calculate the value of the trim resistor,

Rtrim for a desired output voltage, should be as per the following equation:

$$R_{TRIM} = \frac{12}{(V_{O-REQ} - 0.6)} \text{ [k}\Omega\text{]}$$

Rtrim is the external resistor in kohm
Vo-req is the desired output voltage

Note that the tolerance of a trim resistor will affect the tolerance of the output voltage. Standard 1% or 0.5% resistors may suffice for most applications; however, a tighter tolerance can be obtained by using two resistors in series instead of one standard value resistor.

Table 1 lists calculated values of *R_{TRIM}* for common output voltages. For each value of *R_{TRIM}*, Table 1 also shows the closest available standard resistor value.

Table 1: Trim Resistor Value	
V _{O-REG} [V]	R _{TRIM} [kΩ]
0.6	Open
0.9	40
1.0	30
1.2	20
1.5	13.33
1.8	10
2.5	6.316
3.3	4.444
5.0	2.727

Remote Sense

The power module has a Remote Sense feature to minimize the effects of distribution losses by regulating the voltage between the SENSE pins (VS+ and VS-). The voltage drop between the SENSE pins and the VOUT and GND pins of the module should not exceed 0.5V.

Voltage Margining

Output voltage margining can be implemented in the module by connecting a resistor, *Rmargin-up*, from the Trim pin to the ground pin for margining-up the output voltage and by connecting a resistor, *Rmargin-down*, from the Trim pin to output pin for margining-down. Fig-7 shows the circuit configuration for output voltage margining.

The POL Programming Tool, available at www.fdk.com under the Downloads section, also calculates the values of *Rmargin-up* and *Rmargin-down* for a specific output voltage and %

FGMS12SR6020*A

Data Sheet

3-14.4Vdc Input, 20A, 0.6-5.5Vdc Output

margin. Please consult your local FDK FAE for additional details.

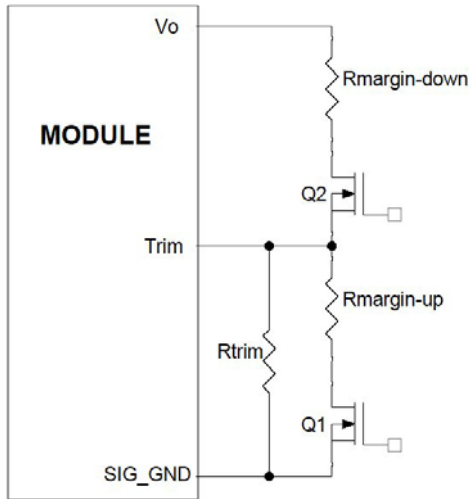

Fig-7: Circuit Configuration for margining Output Voltage.

Output Voltage Sequencing

The power module includes a sequencing feature, EZSEQUENCE that enables users to implement various types of output voltage sequencing in their applications. This is accomplished via an additional sequencing pin. When not using the sequencing feature, leave it unconnected.

The voltage applied to the SEQ pin should be scaled down by the same ratio as used to scale the output voltage down to the reference voltage of the module. This is accomplished by an external resistive divider connected across the sequencing voltage before it is fed to the SEQ pin as shown in Fig-8. In addition, a small capacitor (suggested value 100pF) should be connected across the lower resistor R1.

For all DLynx modules, the minimum recommended delay between the ON/OFF signal and the sequencing signal is 10ms to ensure that the module output is ramped up according to the sequencing signal. This ensures that the module soft-start routine is completed before the sequencing signal is allowed to ramp up.

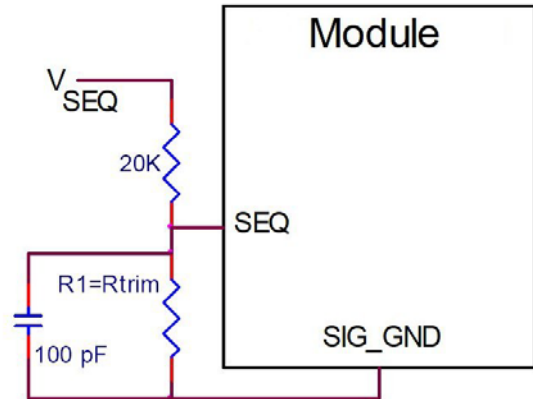

Fig-8: Circuit showing connection of the sequencing signal to the SEQ pin.

When the scaled down sequencing voltage is applied to the SEQ pin, the output voltage tracks this voltage until the output reaches the set-point voltage. The final value of the sequencing voltage must be set higher than the set-point voltage of the module. The output voltage follows the sequencing voltage on a one-to-one basis. By connecting multiple modules together, multiple modules can track their output voltages to the voltage applied on the SEQ pin.

To initiate simultaneous shutdown of the modules, the SEQ pin voltage is lowered in a controlled manner. The output voltage of the modules tracks the voltages below their set-point voltages on a one-to-one basis. A valid input voltage must be maintained until the tracking and output voltages reach ground potential.

Over-Current Protection

To provide protection in a fault (output overload) condition, the unit is equipped with internal current-limiting circuitry and can endure current limiting continuously. At the point of current-limit inception, the unit enters hiccup mode. The unit operates normally once the output current is brought back into its specified range.

Over-Temperature Protection

To provide protection in a fault condition, the unit is equipped with a thermal shutdown circuit. The unit will shut down if the over-temperature threshold of 120°C (typ) is exceeded at the thermal reference point Tref. Once the unit goes into thermal shutdown it will then wait to cool before attempting to restart.

FGMS12SR6020*A

Data Sheet

3-14.4Vdc Input, 20A, 0.6-5.5Vdc Output

Input Under-Voltage Lockout (UVLO)

At input voltages below the input under-voltage lockout limit, the module operation is disabled. The module will begin to operate at an input voltage above the under-voltage lockout turn-on threshold.

Synchronization

The module switching frequency can be synchronized to a signal with an external frequency within a specified range. Synchronization can be done by using the external signal applied to the SYNC pin of the module as shown in Fig-1, with the converter being synchronized by the rising edge of the external signal. The Electrical Specifications table specifies the requirements of the external SYNC signal. **If synchronization is not being used, connect the SYNC pin to GND.**

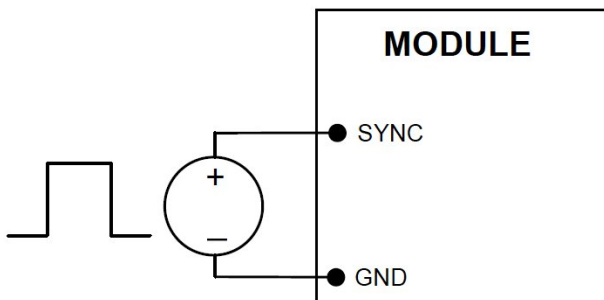

Fig-9: External source connections to synchronize switching frequency of the module.

Dual Layout

Identical dimensions and pin layout of Analog and Digital **Tomodachi** modules permit migration from one to the other without needing to change the layout. In both cases the trim resistor is connected between trim and signal ground SIG_GND. The output of the analog module cannot be trimmed down to 0.45V

Power Good

The module provides a Power Good (PGOOD) signal that is implemented with an open-drain output to indicate that the output voltage is within the regulation limits of the power module. The PGOOD signal will be de-asserted to a low state if any condition such as over-temperature, over-current or loss of regulation occurs that would result in the output voltage going $\pm 10\%$ outside the setpoint value.

The PGOOD terminal can be connected through a pull-up resistor (suggested value 100K Ω) to a source of 5VDC or lower.

Tunable Loop™

The module has a feature that optimizes transient response of the module called Tunable Loop™

External capacitors are usually added to the output of the module for two reasons: to reduce output ripple and noise (see Figure 38) and to reduce output voltage deviations from the steady-state value in the presence of dynamic load current changes. Adding external capacitance however affects the voltage control loop of the module, typically causing the loop to slow down with sluggish response. Larger values of external capacitance could also cause the module to become unstable.

The Tunable Loop™ allows the user to externally adjust the voltage control loop to match the filter network connected to the output of the module. The Tunable Loop™ is implemented by connecting a series R-C between the VS+ and TRIM pins of the module, as shown in Fig-10. This R-C allows the user to externally adjust the voltage loop feedback compensation of the module.

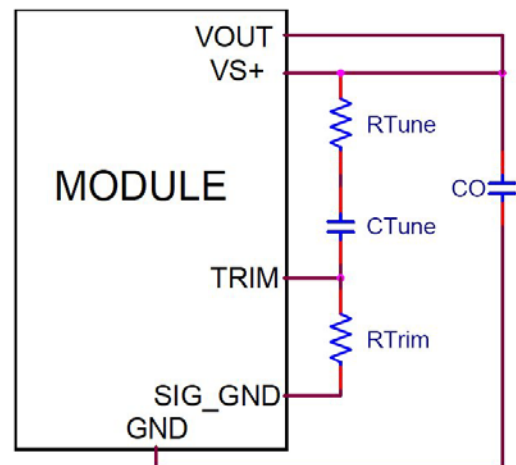

Fig-10: Circuit diagram showing connection of R_{TUNE} and C_{TUNE} to tune the control loop of the module.

Recommended values of R_{TUNE} and C_{TUNE} for different output capacitor combinations are given in Tables 2. Table 2 shows the recommended values of R_{TUNE} and C_{TUNE} for different values of ceramic output capacitors up to 1000uF that might be needed for an application to meet output ripple and noise requirements. Selecting R_{TUNE} and C_{TUNE} according to Table 2 will ensure stable operation of the module. In

FGMS12SR6020*A

Data Sheet

3-14.4Vdc Input, 20A, 0.6-5.5Vdc Output

applications with tight output voltage limits in the presence of dynamic current loading, additional output capacitance will be required. Table 3 lists recommended values of R_{TUNE} and C_{TUNE} in order to meet 2% output voltage deviation limits for some common output voltages in the presence of a 10A to 20A step change (50% of full load), with an input voltage of 12V.

Please contact your FDK technical representative to obtain more details of this feature as well as for guidelines on how to select the right value of external R-C to tune the module for best transient performance and stable operation for other output capacitance values.

Table 2: General recommended value of R_{TUNE} and C_{TUNE} for $V_{in}=12V$ and various external ceramic capacitor combinations.

Co	2x47uF	4x47uF	6x47uF	10x47uF	20x47uF
R_{TUNE}	330	330	270	220	180
C_{TUNE}	47pF	560pF	1200pF	2200pF	4700pF

Table 3: Recommended values of R_{TUNE} and C_{TUNE} to obtain transient deviation of 2% of V_{out} for a 10A step load with $V_{in}=12V$.

V_o	5V	3.3V	2.5V	1.8V	1.2V	0.6V
Co	8x47uF	5x47uF + 1x330uF Polymer	2x47uF + 2x330uF Polymer	2x47uF + 3x330uF Polymer	1x47uF + 5x330uF Polymer	1x47uF + 11x330uF Polymer
R_{TUNE}	220	220	220	220	180	180
C_{TUNE}	1500pF	2200pF	3300pF	5600pF	10nF	47nF
ΔV	100mV	64mV	49mV	36mV	24mV	12mV

Note: The capacitors used in the Tunable Loop tables are 47 $\mu F/3$ m Ω ESR ceramic and 330 $\mu F/12$ m Ω ESR polymer capacitors.

FGMS12SR6020*A

Data Sheet

3-14.4Vdc Input, 20A, 0.6-5.5Vdc Output

Characterization

Overview

The converter has been characterized for several operational features, including efficiency, thermal derating (maximum available load current as a function of ambient temperature and airflow), ripple and noise, transient response to load step changes, start-up and shutdown characteristics. Figures showing data plots and waveforms for different output voltages are presented in the following pages.

Thermal Considerations

Power modules operate in a variety of thermal environments; however, sufficient cooling should always be provided to help ensure reliable operation. Considerations include ambient temperature, airflow, module power dissipation, and the need for increased reliability. A reduction in the operating temperature of the module will result in an increase in reliability. The thermal data presented here is based on physical measurements taken in a wind tunnel. The test set-up is shown in Fig-K. The preferred airflow direction for the module is in Fig-11.

Note that continuous operation beyond the derated current as specified by the derating curves may lead to degradation in performance and reliability of the converter and may result in permanent damage.

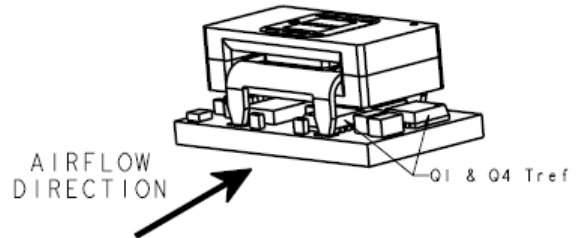

Fig-12: Preferred airflow direction and location of hot-spot of the module (Tref).

The main heat dissipation method of this converter is to transfer its heat to the system board. Thus, if the temperature of the system board goes high, even with the low ambient temperature, it may exceed the guaranteed temperature of components.

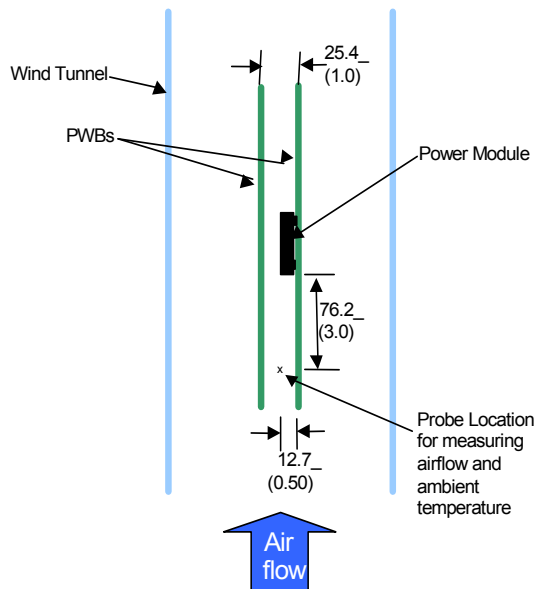

Fig-11: Thermal test set-up

The thermal reference points, T_{ref} used in the specifications are also shown in Fig-12. For reliable operation the temperatures at these points should not exceed 130°C. The output power of the module should not exceed the rated power of the module ($V_{o,set} \times I_{o,max}$).

FGMS12SR6020*A

Data Sheet

3-14.4Vdc Input, 20A, 0.6-5.5Vdc Output

Characteristic Curves

The following figures provide typical characteristics for the 20A Analog **Tomodachi** at 5V_o and 25°C

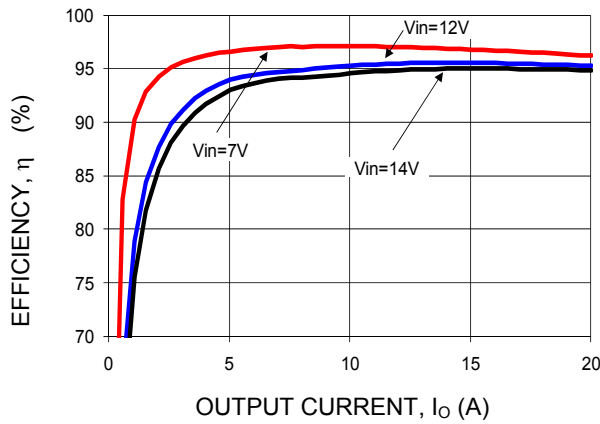

Fig-13. Converter Efficiency versus Output Current.

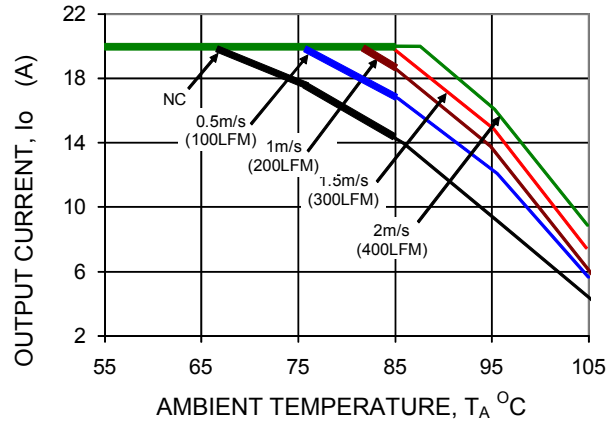

Fig-14. Derating Output Current versus Ambient Temperature and Airflow.

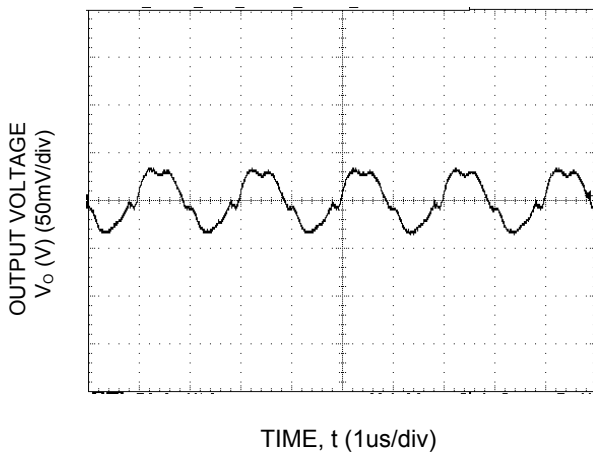

Fig-15. Typical output ripple and noise (C_O=2x47uF ceramic, V_{IN} = 12V, I_o = I_{o,max}).

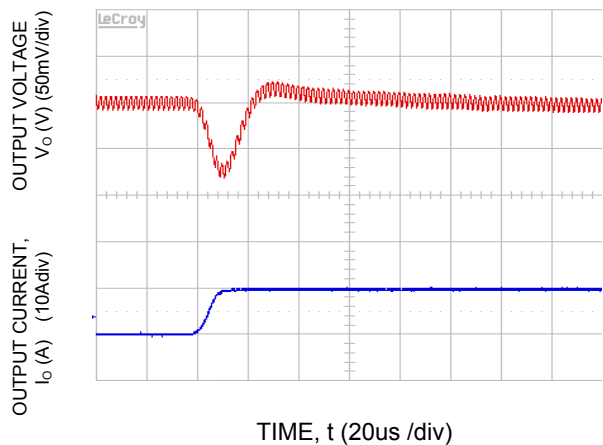

Fig-16. Transient Response to Dynamic Load Change from 50% to 100% at 12Vin, C_{out}= 8x47uF, C_{Tune}=1500pF & R_{Tune}=220 ohms

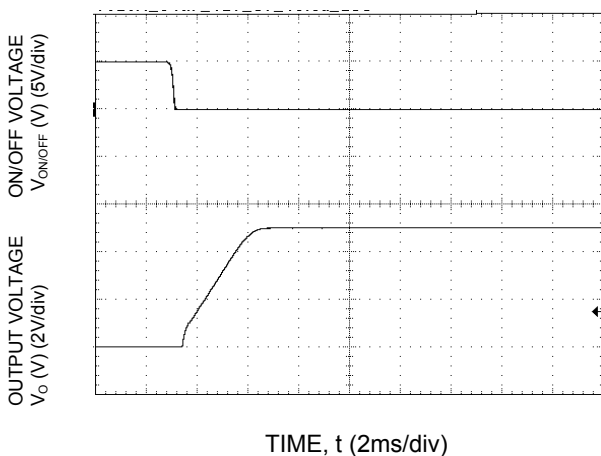

Fig-17. Typical Start-up Using On/Off Voltage (I_o = I_{o,max}).

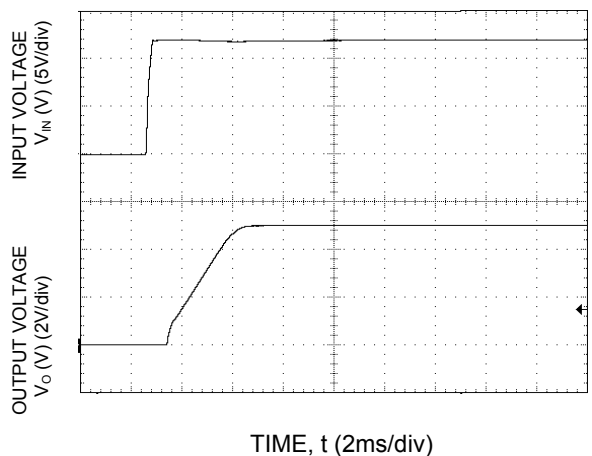

Fig-18. Typical Start-up Using Input Voltage (V_{IN} = 12V, I_o = I_{o,max}).

FGMS12SR6020*A

Data Sheet

3-14.4Vdc Input, 20A, 0.6-5.5Vdc Output

Characteristic Curves

The following figures provide typical characteristics for the 20A Analog **Tomodachi** at 3.3V_o and 25°C

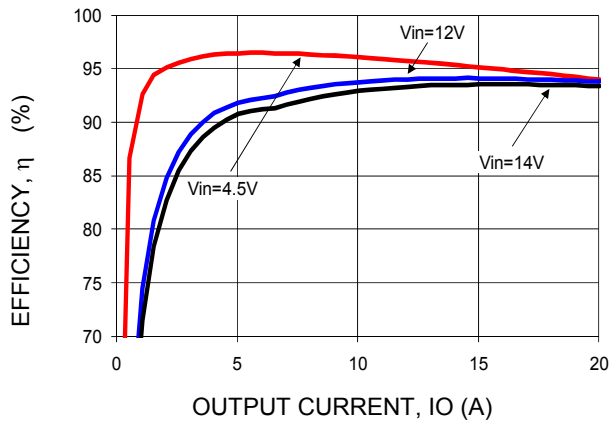

Fig-19. Converter Efficiency versus Output Current.

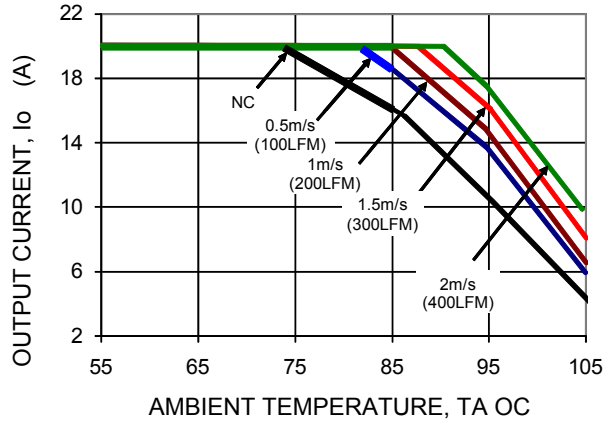

Fig-20. Derating Output Current versus Ambient Temperature and Airflow.

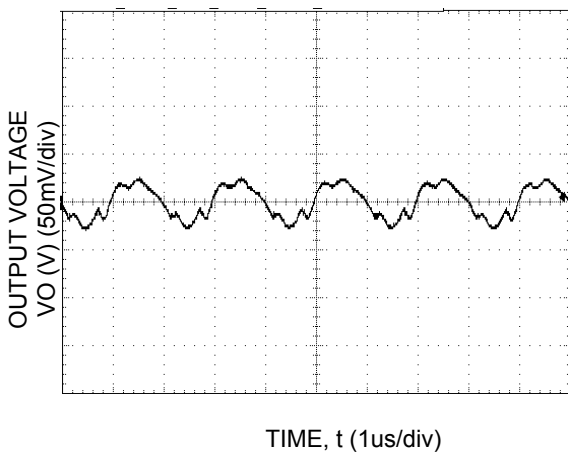

Fig-21. Typical output ripple and noise (CO=2x47uF ceramic, VIN = 12V, Io = Io,max,).

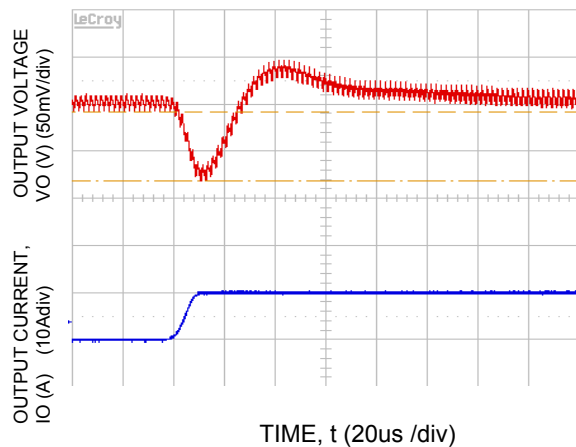

Fig-22. Transient Response to Dynamic Load Change from 50% to 100% at 12Vin, Cout= 5x47uF +1x330uF, CTune=2200pF & RTune=220 ohms

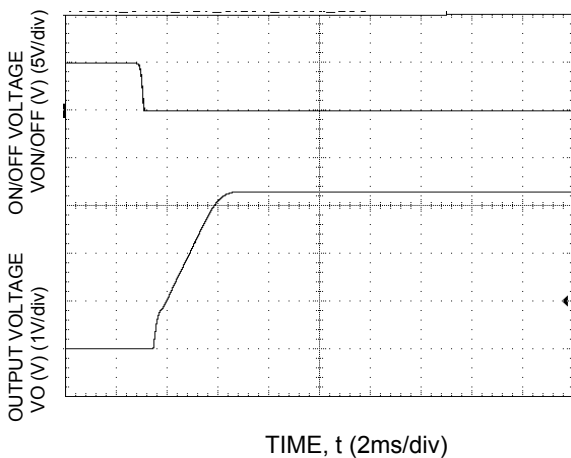

Fig-23. Typical Start-up Using On/Off Voltage (Io = Io,max).

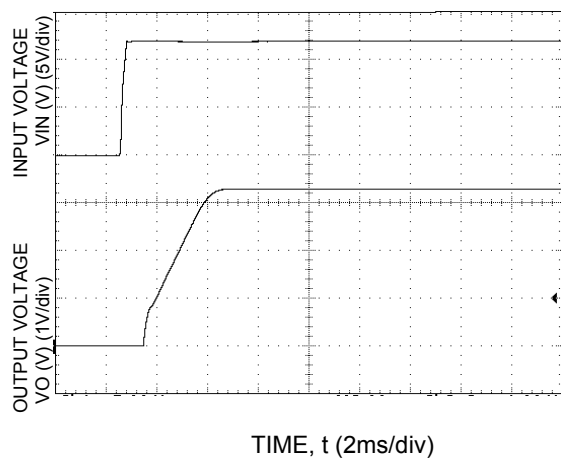

Fig-24. Typical Start-up Using Input Voltage (VIN = 12V, Io = Io,max).

FGMS12SR6020*A

Data Sheet

3-14.4Vdc Input, 20A, 0.6-5.5Vdc Output

Characteristic Curves

The following figures provide typical characteristics for the 20A Analog **Tomodachi** at 2.5Vo and 25°C

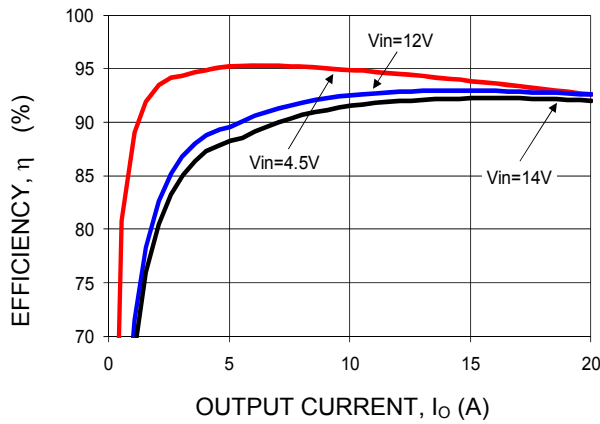

Fig-25. Converter Efficiency versus Output Current.

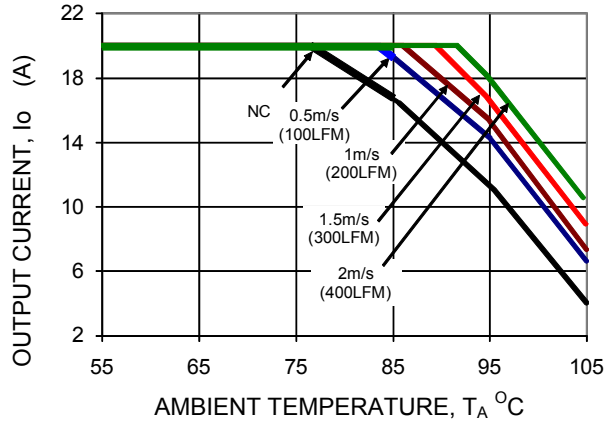

Fig-26. Derating Output Current versus Ambient Temperature and Airflow.

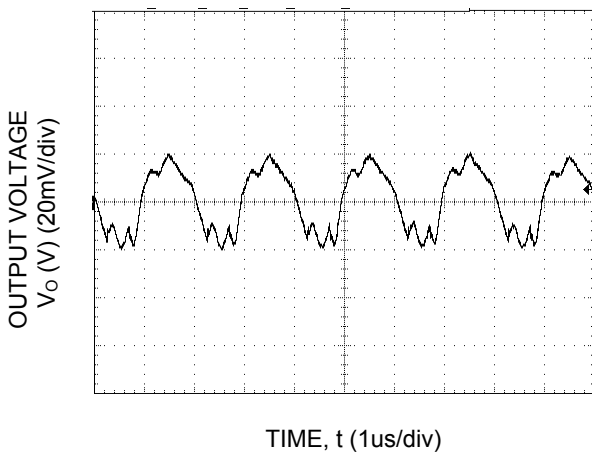

Fig-27. Typical output ripple and noise (CO=2x47uF ceramic, VIN = 12V, Io = Io,max,).

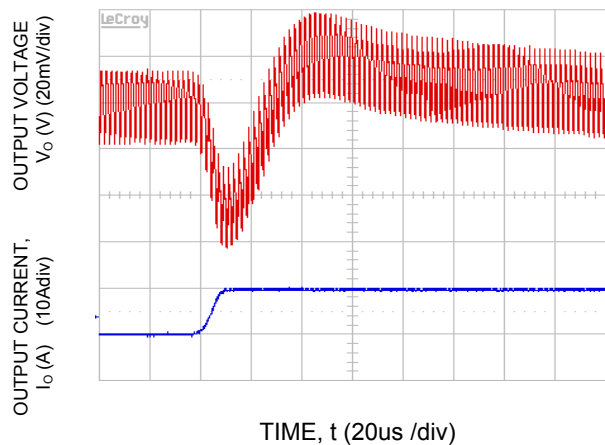

Fig-28. Transient Response to Dynamic Load Change from 50% to 100% at 12Vin, Cout= 2x47uF +2x330uF, CTune=3300pF & RTune=220 ohms

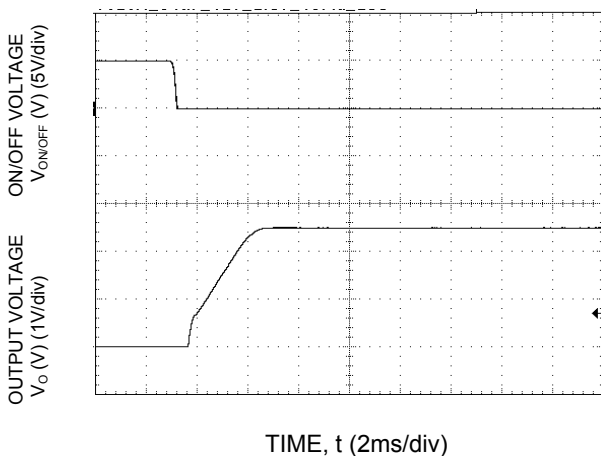

Fig-29. Typical Start-up Using On/Off Voltage (Io = Io,max).

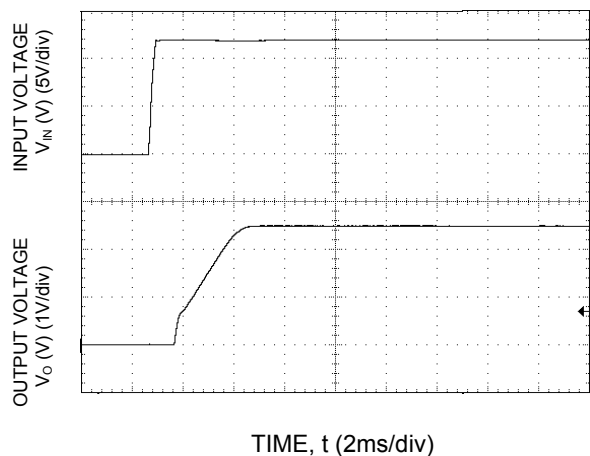

Fig-30. Typical Start-up Using Input Voltage (VIN = 12V, Io = Io,max).

FGMS12SR6020*A

Data Sheet

3-14.4Vdc Input, 20A, 0.6-5.5Vdc Output

Characteristic Curves

The following figures provide typical characteristics for the 20A Analog **Tomodachi** at 1.8Vo and 25°C

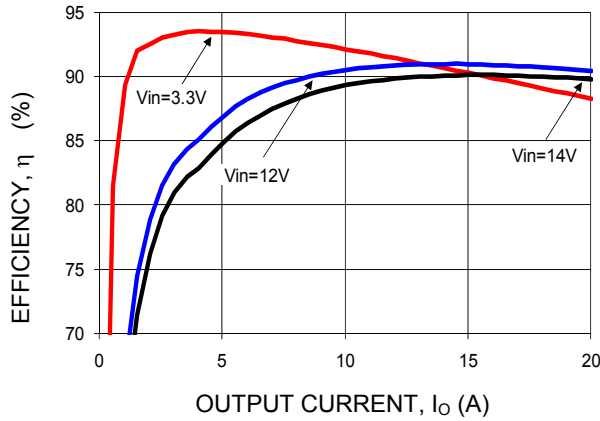

Fig-31. Converter Efficiency versus Output Current.

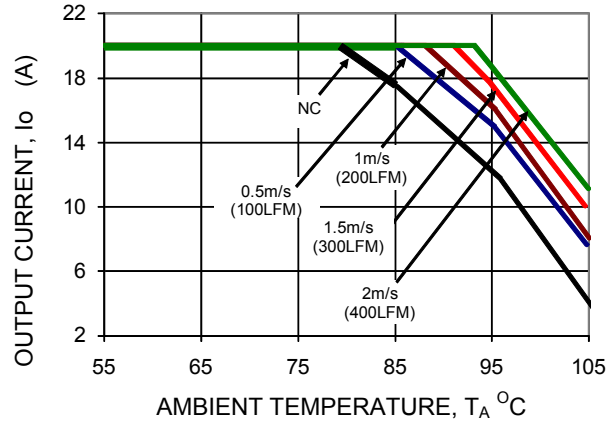

Fig-32. Derating Output Current versus Ambient Temperature and Airflow.

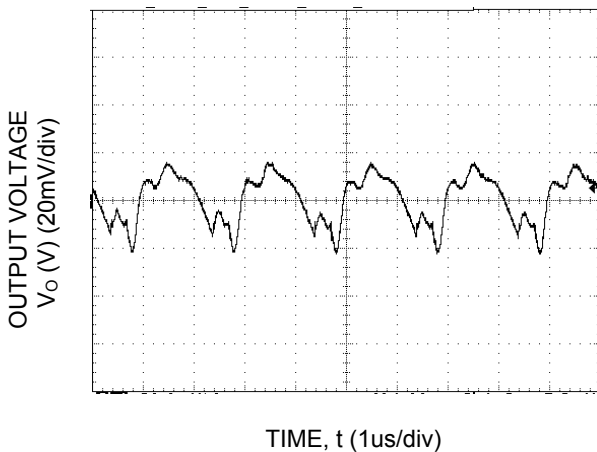

Fig-33. Typical output ripple and noise (CO=2X47uF ceramic, VIN = 12V, Io = Io,max,).

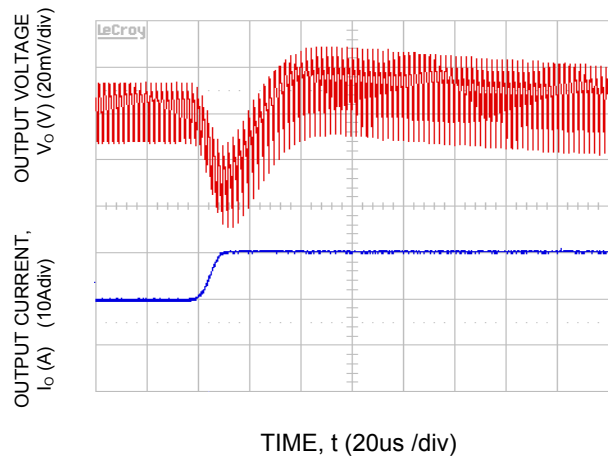

Fig-34. Transient Response to Dynamic Load Change from 50% to 100% at 12Vin, Cout= 2x47uF +3x330uF, CTune=5600pF & RTune=220 ohms

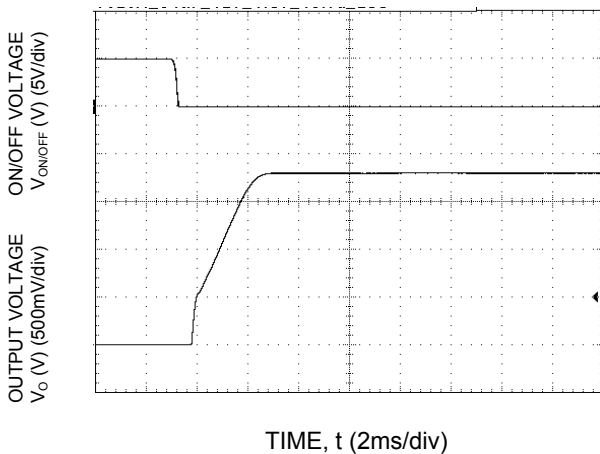

Fig-35. Typical Start-up Using On/Off Voltage (Io = Io,max).

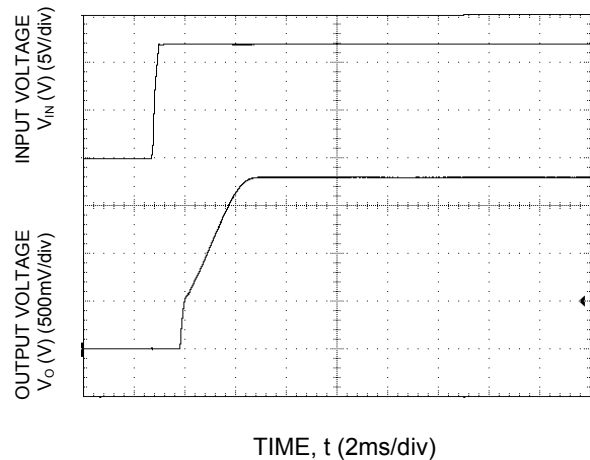

Fig-36. Typical Start-up Using Input Voltage (VIN = 12V, Io = Io,max).

FGMS12SR6020*A

Data Sheet

3-14.4Vdc Input, 20A, 0.6-5.5Vdc Output

Characteristic Curves

The following figures provide typical characteristics for the 20A Analog **Tomodachi** at 1.2Vo and 25°C

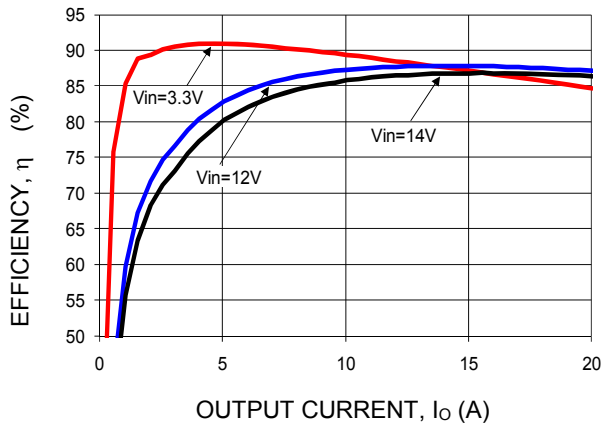

Fig-37. Converter Efficiency versus Output Current.

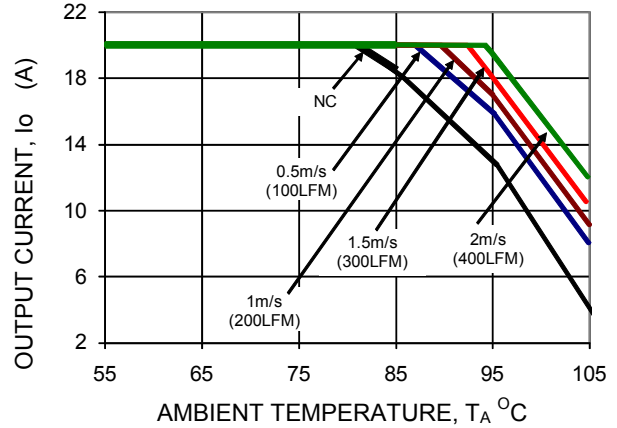

Fig-38. Derating Output Current versus Ambient Temperature and Airflow.

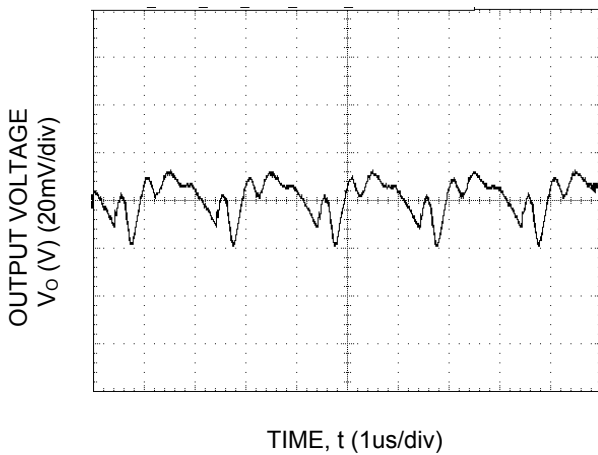

Fig-39. Typical output ripple and noise (CO=2x47uF ceramic, VIN = 12V, I_o = I_{o,max},).

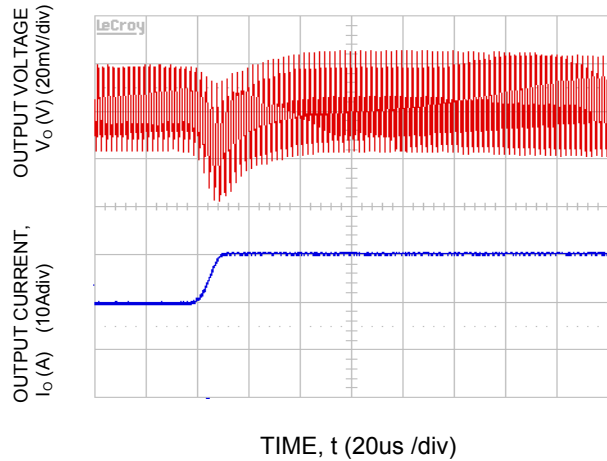

Fig-40. Transient Response to Dynamic Load Change from 50% to 100% at 12Vin, Cout= 1x47uF +5x330uF, CTune=10nF & RTune=178 ohms

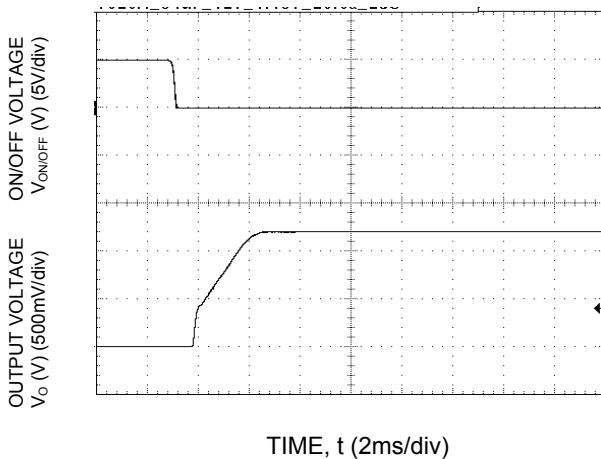

Fig-41. Typical Start-up Using On/Off Voltage (I_o = I_{o,max}).

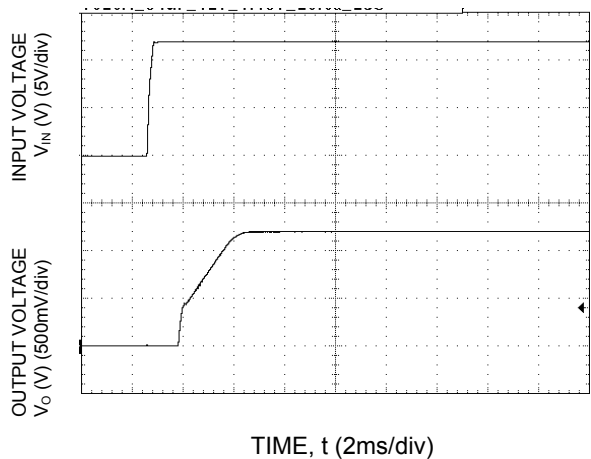

Fig-42. Typical Start-up Using Input Voltage (VIN = 12V, I_o = I_{o,max}).

FGMS12SR6020*A

Data Sheet

3-14.4Vdc Input, 20A, 0.6-5.5Vdc Output

Characteristic Curves

The following figures provide typical characteristics for the 20A Analog **Tomodachi** at 0.6V_o and 25°C

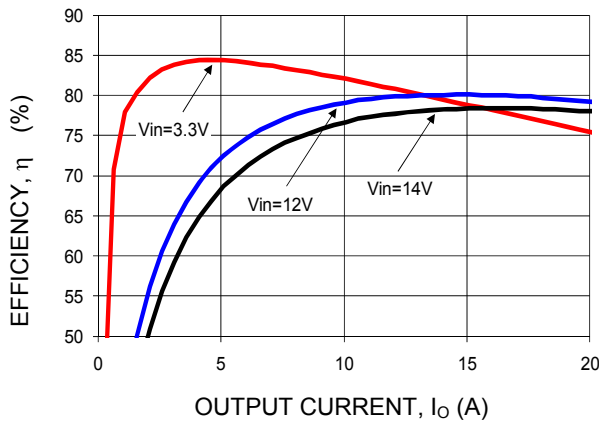

Fig-43. Converter Efficiency versus Output Current.

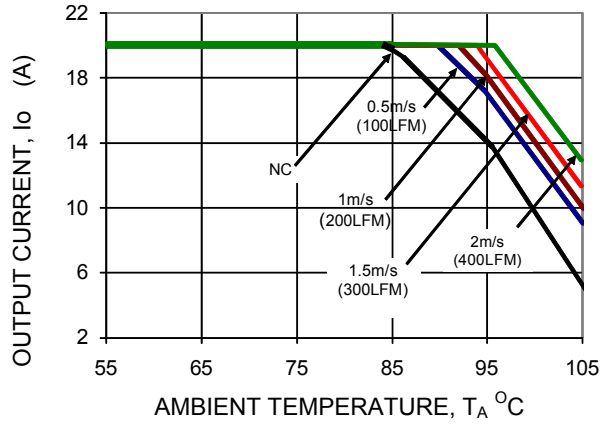

Fig-44. Derating Output Current versus Ambient Temperature and Airflow.

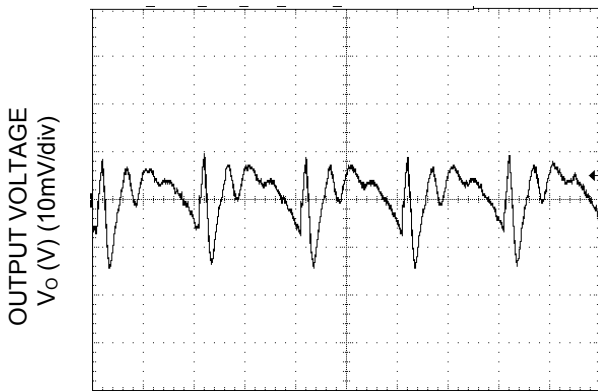

Fig-45. Typical output ripple and noise (C_O=2x47uF ceramic, V_{IN} = 12V, I_o = I_{o,max},).

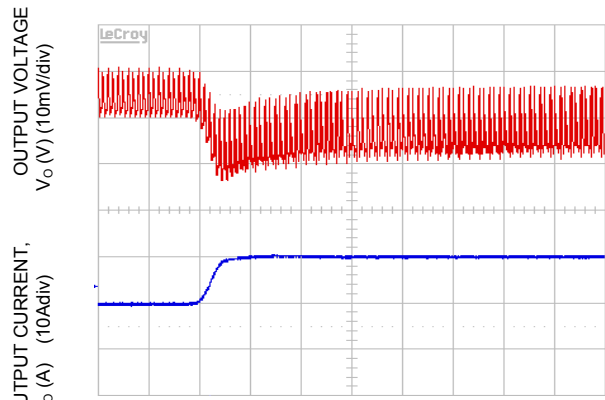

Fig-46. Transient Response to Dynamic Load Change from 50% to 100% at 12V_{in}, C_{out}= 1x47uF +11x330uF C_{Tune}=47nF, R_{Tune}=178 ohms

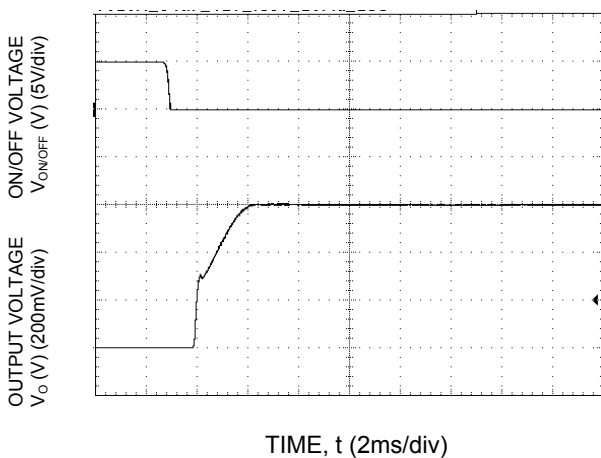

Fig-47. Typical Start-up Using On/Off Voltage (I_o = I_{o,max}).

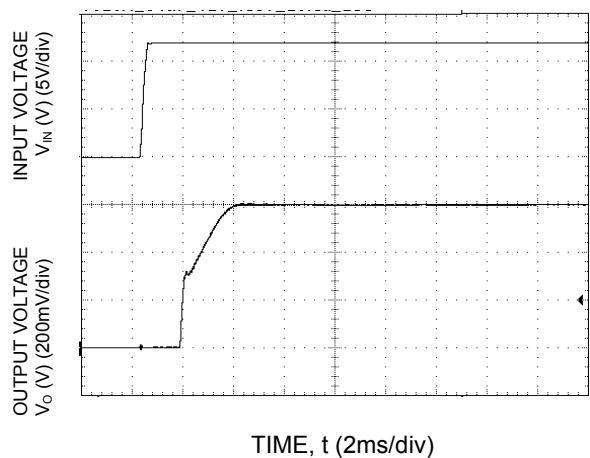

Fig-48. Typical Start-up Using Input Voltage (V_{IN} = 12V, I_o = I_{o,max}).

FGMS12SR6020*A

Data Sheet

3-14.4Vdc Input, 20A, 0.6-5.5Vdc Output

Example Application Circuit

Requirements:

Vin: 12V
 Vout: 1.8V
 Iout: 15A max., worst case load transient is from 10A to 15A
 ΔV_{out} : 1.5% of Vout (27mV) for worst case load transient
 Vin, ripple: 1.5% of Vin (180mV, p-p)

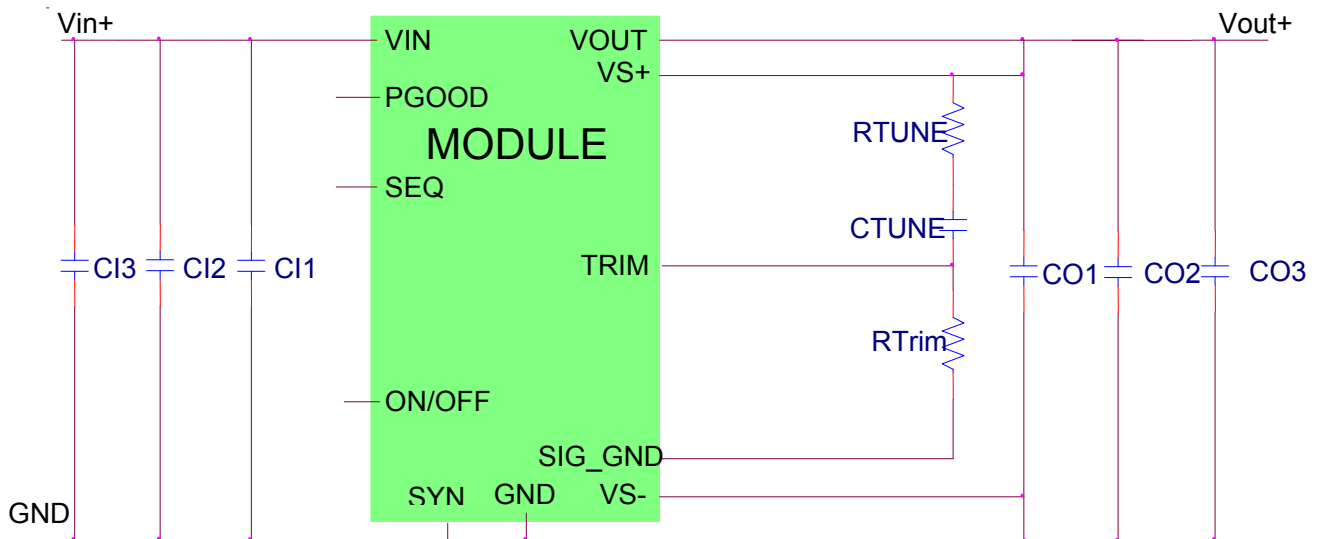

- C11 Decoupling cap - 1x0.047uF/16V ceramic capacitor (e.g. Murata LLL185R71C473MA01)
- C12 3x22uF/16V ceramic capacitor (e.g. Murata GRM32ER61C226KE20)
- C13 47uF/16V bulk electrolytic
- CO1 Decoupling cap - 1x0.047uF/16V ceramic capacitor (e.g. Murata LLL185R71C473MA01)
- CO2 N/A
- CO3 3 x 330uF/6.3V Polymer (e.g. Sanyo Poscap)
- CTune 4700pF ceramic capacitor (can be 1206, 0805 or 0603 size)
- RTune 330 ohms SMT resistor (can be 1206, 0805 or 0603 size)
- RTrim 10kΩ SMT resistor (can be 1206, 0805 or 0603 size, recommended tolerance of 0.1%)

FGMS12SR6020*A

Data Sheet

3-14.4Vdc Input, 20A, 0.6-5.5Vdc Output

Mechanical Drawing

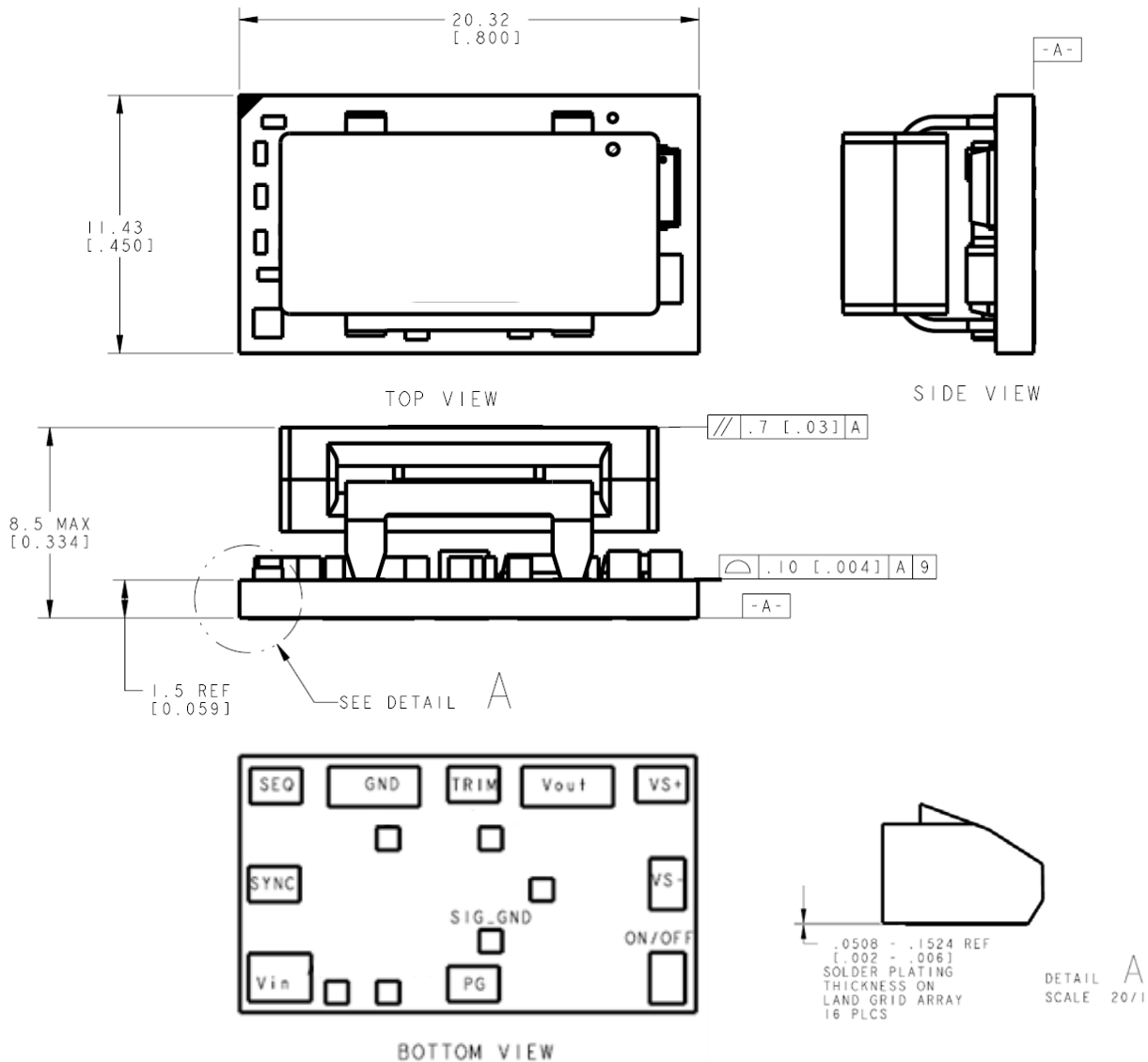

Pin Connections			
Pin #	Function	Pin #	Function
1	ON/OFF	9	PG
2	Vin	10	SYNC*
3	SEQ	11	NC
4	GND	12	NC
5	TRIM	13	NC
6	Vout	14	GIG_GND
7	VS+	15	NC
8	VS-	16	NC

Notes

- All dimensions are in millimeters (inches)
- Tolerances:
x.x mm ± 0.5 mm (x.xx in. ± 0.02 in.)
[unless otherwise indicated]
x.xx mm ± 0.25 mm (x.xxx in ± 0.010 in.)

* If unused, connect to Ground

FGMS12SR6020*A

Data Sheet

3-14.4Vdc Input, 20A, 0.6-5.5Vdc Output

Recommended Pad Layout

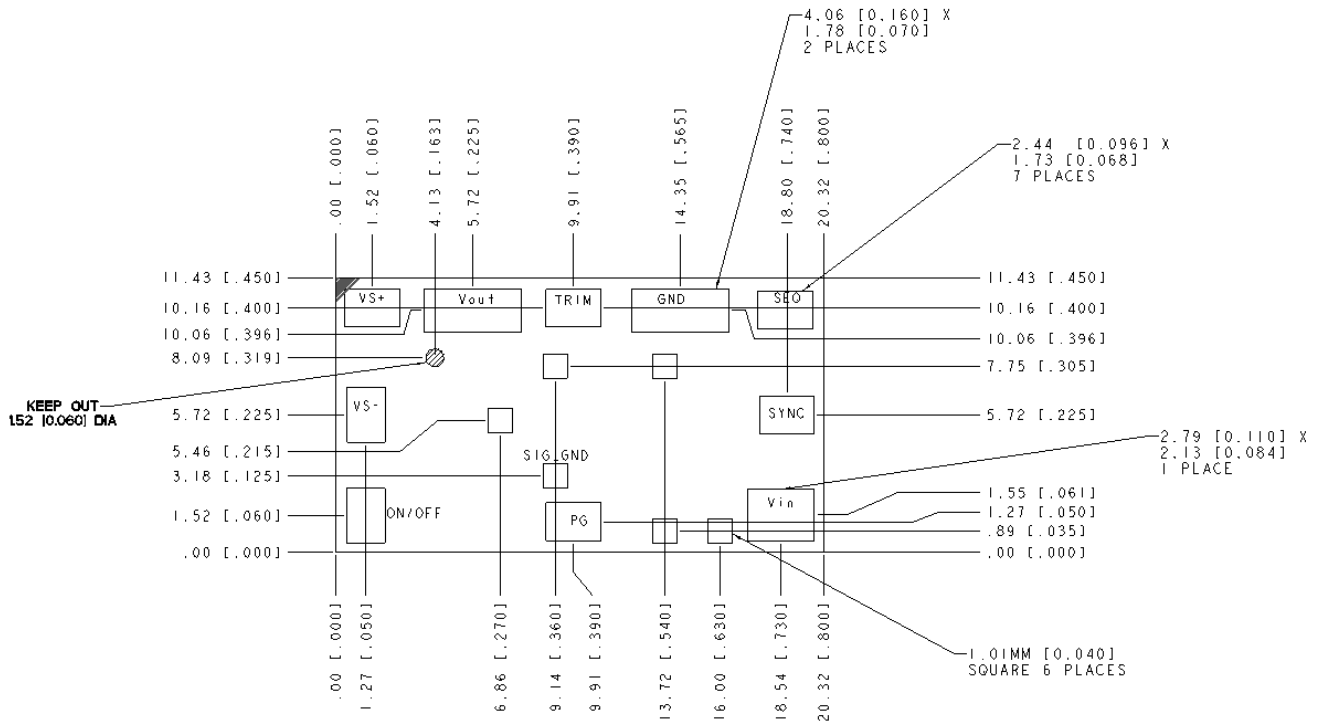

RECOMMENDED FOOTPRINT
-THROUGH THE BOARD-

Pin Connections			
Pin #	Function	Pin #	Function
1	ON/OFF	9	PG
2	Vin	10	SYNC*
3	SEQ	11	NC
4	GND	12	NC
5	TRIM	13	NC
6	Vout	14	GIG_GND
7	VS+	15	NC
8	VS-	16	NC

Notes

- All dimensions are in millimeters (inches)
- Tolerances:
 x.x mm ± 0.5 mm (x.xx in. ± 0.02 in.)
 [unless otherwise indicated]
 x.xx mm ± 0.25 mm (x.xxx in ± 0.010 in.)

* If unused, connect to Ground

FGMS12SR6020*A

Data Sheet

3-14.4Vdc Input, 20A, 0.6-5.5Vdc Output

Packaging Detail

The 20A Analog *Tomodachi* modules are supplied in tape & reel as standard. Modules are shipped in quantities of 200 modules per reel.

All Dimensions are in millimeters and (in inches).

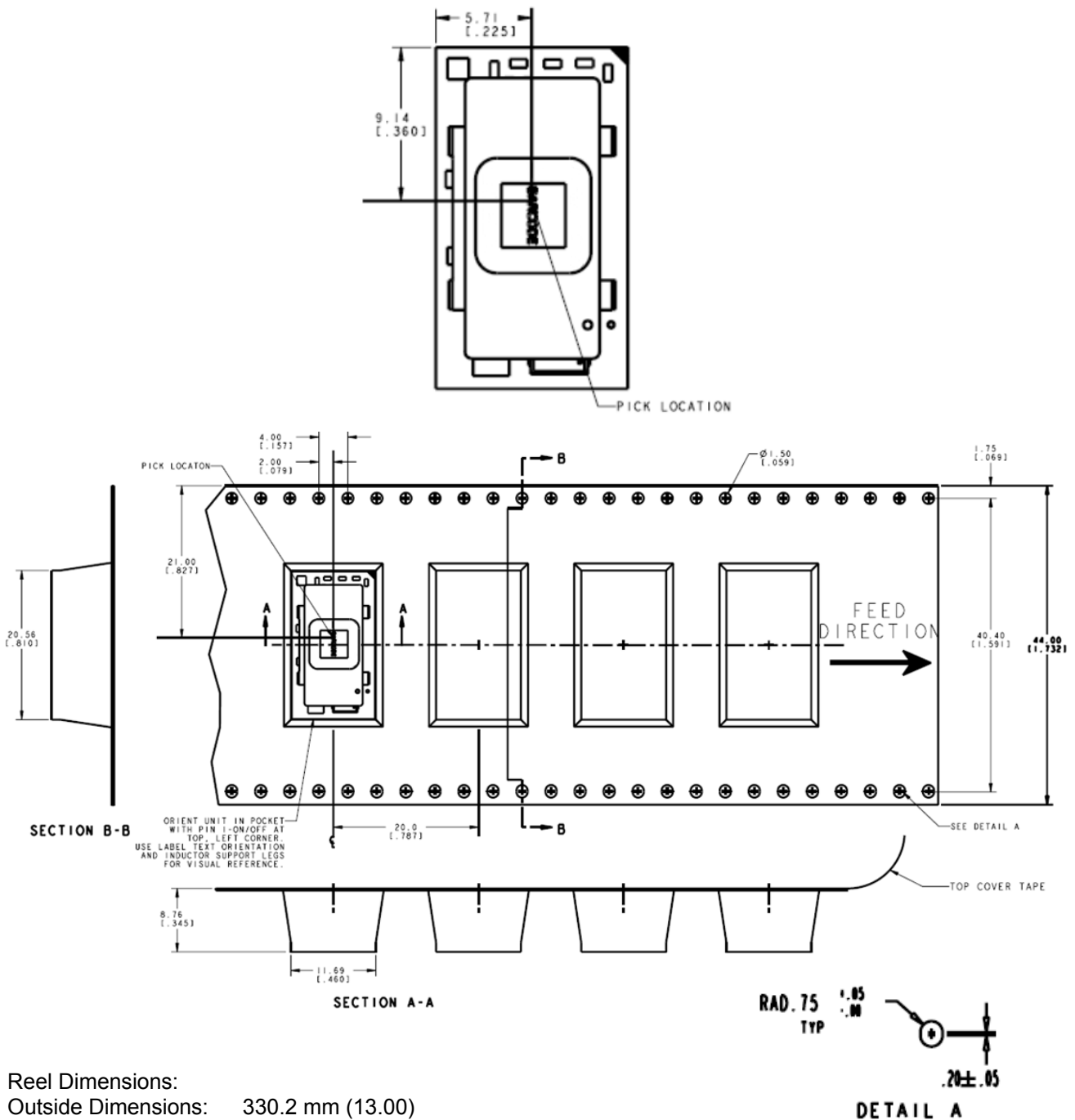

Reel Dimensions:
 Outside Dimensions: 330.2 mm (13.00")
 Inside Dimensions: 177.8 mm (7.00")
 Tape Width: 44.00 mm (1.732")

FGMS12SR6020*A

3-14.4Vdc Input, 20A, 0.6-5.5Vdc Output

Data Sheet

Surface Mount Information

Pick and Place

The 20A Analog **Tomodachi** modules use an open frame construction and are designed for a fully automated assembly process. The modules are fitted with a label designed to provide a large surface area for pick and place operations. The label meets all the requirements for surface mount processing, as well as safety standards, and is able to withstand reflow temperatures of up to 300°C. The label also carries product information such as product code, serial number and the location of manufacture.

Nozzle Recommendations

The module weight has been kept to a minimum by using open frame construction. Variables such as nozzle size, tip style, vacuum pressure and placement speed should be considered to optimize this process. The minimum recommended inside nozzle diameter for reliable operation is 3mm. The maximum nozzle outer diameter, which will safely fit within the allowable component spacing, is 7mm.

Bottom Side / First Side Assembly

This module is not recommended for assembly on the bottom side of a customer board. If such an assembly is attempted, components may fall off the module during the second reflow process.

Lead Free Soldering

The modules are lead-free (Pb-free) and RoHS compliant and fully compatible in a Pb-free soldering process. Failure to observe the instructions below may result in the failure of or cause damage to the modules and can adversely affect long-term reliability.

Pb-free Reflow Profile

Power Systems will comply with J-STD-020 Rev. C (Moisture / Reflow Sensitivity Classification for Nonhermetic Solid State Surface Mount Devices) for both Pb-free solder profiles and MSL classification procedures. This standard provides a recommended forced-air-convection reflow profile based on the volume and thickness of the package (table 4-2). The suggested Pb-free solder paste is Sn/Ag/Cu (SAC). For questions regarding Land grid array (LGA) soldering, solder volume; please contact Lineage Power for special manufacturing process

instructions. The recommended linear reflow profile using Sn/Ag/Cu solder is shown in Fig-49. Soldering outside of the recommended profile requires testing to verify results and performance.

MSL Rating

The 20A Analog **Tomodachi** modules have a MSL rating of 2a.

Storage and Handling

The recommended storage environment and handling procedures for moisture-sensitive surface mount packages is detailed in J-STD-033 Rev. A (Handling, Packing, Shipping and Use of Moisture/Reflow Sensitive Surface Mount Devices). Moisture barrier bags (MBB) with desiccant are required for MSL ratings of 2 or greater. These sealed packages should not be broken until time of use. Once the original package is broken, the floor life of the product at conditions of $\leq 30^{\circ}\text{C}$ and 60% relative humidity varies according to the MSL rating (see J-STD-033A). The shelf life for dry packed SMT packages will be a minimum of 12 months from the bag seal date, when stored at the following conditions: $< 40^{\circ}\text{C}$, $< 90\%$ relative humidity.

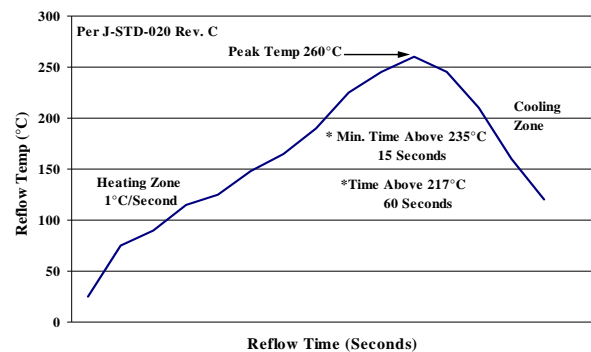

Fig-49: Recommended linear reflow profile using Sn/Ag/Cu solder.

Post Solder Cleaning and Drying Considerations

Post solder cleaning is usually the final circuit-board assembly process prior to electrical board testing. The result of inadequate cleaning and drying can affect both the reliability of a power module and the testability of the finished circuit-board assembly. For guidance on appropriate soldering, cleaning and drying procedures, refer to *Board Mounted Power Modules: Soldering and Cleaning Application Note (AN04-001)*.

FGMS12SR6020*A**Data Sheet**

3-14.4Vdc Input, 20A, 0.6-5.5Vdc Output

Part Number System

Product Series	Shape	Regulation	Input Voltage	Mounting Scheme	Output Voltage	Rated Current	ON/OFF Logic	Pin Shape
FG	M	S	12	S	R60	20	*	A
Series Name	Middle	S: With tracking	Typ=12V	Surface Mount	0.60V (Programmable: See page 6)	20A	N: Negative P: Positive	Standard

Cautions

NUCLEAR AND MEDICAL APPLICATIONS: FDK Corporation products are not authorized for use as critical components in life support systems, equipment used in hazardous environments, or nuclear control systems without the written consent of FDK Corporation.

SPECIFICATION CHANGES AND REVISIONS: Specifications are version-controlled, but are subject to change without notice.

Компания «Life Electronics» занимается поставками электронных компонентов импортного и отечественного производства от производителей и со складов крупных дистрибьюторов Европы, Америки и Азии.

С конца 2013 года компания активно расширяет линейку поставок компонентов по направлению коаксиальный кабель, кварцевые генераторы и конденсаторы (керамические, пленочные, электролитические), за счёт заключения дистрибьюторских договоров

Мы предлагаем:

- Конкурентоспособные цены и скидки постоянным клиентам.
- Специальные условия для постоянных клиентов.
- Подбор аналогов.
- Поставку компонентов в любых объемах, удовлетворяющих вашим потребностям.
- Приемлемые сроки поставки, возможна ускоренная поставка.
- Доставку товара в любую точку России и стран СНГ.
- Комплексную поставку.
- Работу по проектам и поставку образцов.
- Формирование склада под заказчика.
- Сертификаты соответствия на поставляемую продукцию (по желанию клиента).
- Тестирование поставляемой продукции.
- Поставку компонентов, требующих военную и космическую приемку.
- Входной контроль качества.
- Наличие сертификата ISO.

В составе нашей компании организован Конструкторский отдел, призванный помогать разработчикам, и инженерам.

Конструкторский отдел помогает осуществить:

- Регистрацию проекта у производителя компонентов.
- Техническую поддержку проекта.
- Защиту от снятия компонента с производства.
- Оценку стоимости проекта по компонентам.
- Изготовление тестовой платы монтаж и пусконаладочные работы.



Тел: +7 (812) 336 43 04 (многоканальный)

Email: org@lifeelectronics.ru