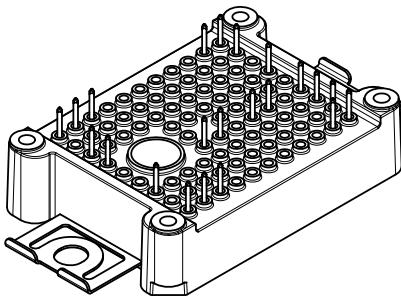
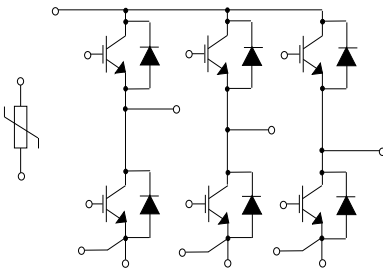

## ACEPACK™ 1 sixpack topology, 650 V, 50 A, trench gate field-stop M series IGBT with soft diode and NTC

**ACEPACK™ 1**

### Features

- ACEPACK™ 1 power module
  - DBC Cu Al<sub>2</sub>O<sub>3</sub> Cu
- Sixpack topology
  - 650 V, 50 A IGBTs and diodes
  - Soft and fast recovery diode
- Integrated NTC

### Applications

- Inverters
- Industrial
- Motor drives

### Description

This power module is a sixpack topology in an ACEPACK™ 1 package with NTC, integrating the advanced trench gate field-stop technologies from STMicroelectronics. This new IGBT technology represents the best compromise between conduction and switching loss, to maximize the efficiency of any converter system up to 20 kHz.



#### Product status

A1P50S65M2

#### Product summary

<b>Order code</b>	A1P50S65M2
<b>Marking</b>	A1P50S65M2
<b>Package</b>	ACEPACK™ 1
<b>Leads type</b>	Solder contact pins

# 1 Electrical ratings

## 1.1 IGBT

Limiting values at  $T_J = 25\text{ °C}$ , unless otherwise specified.

**Table 1. Absolute maximum ratings of the IGBT**

Symbol	Parameter	Value	Unit
$V_{CES}$	Collector-emitter voltage ( $V_{GE} = 0\text{ V}$ )	650	V
$I_C$	Continuous collector current ( $T_C = 100\text{ °C}$ )	50	A
$I_{CP}^{(1)}$	Pulsed collector current ( $t_p = 1\text{ ms}$ )	100	A
$V_{GE}$	Gate-emitter voltage	$\pm 20$	V
$P_{TOT}$	Total power dissipation of each IGBT ( $T_C = 25\text{ °C}$ , $T_J = 175\text{ °C}$ )	208	W
$T_{JMAX}$	Maximum junction temperature	175	$^{\circ}\text{C}$
$T_{Jop}$	Operating junction temperature range under switching conditions	-40 to 150	$^{\circ}\text{C}$

1. Pulse width limited by maximum junction temperature.

**Table 2. Electrical characteristics of the IGBT**

Symbol	Parameter	Test conditions	Min.	Typ.	Max.	Unit
$V_{(BR)CES}$	Collector-emitter breakdown voltage	$I_C = 1\text{ mA}$ , $V_{GE} = 0\text{ V}$	650			V
$V_{CE(sat)}$ (terminal)	Collector-emitter saturation voltage	$V_{GE} = 15\text{ V}$ , $I_C = 50\text{ A}$ $V_{GE} = 15\text{ V}$ , $I_C = 50\text{ A}$ , $T_J = 150\text{ °C}$		1.95 2.3	2.3	V
$V_{GE(th)}$	Gate threshold voltage	$V_{CE} = V_{GE}$ , $I_C = 1\text{ mA}$	5	6	7	V
$I_{CES}$	Collector cut-off current	$V_{GE} = 0\text{ V}$ , $V_{CE} = 650\text{ V}$			100	$\mu\text{A}$
$I_{GES}$	Gate-emitter leakage current	$V_{CE} = 0\text{ V}$ , $V_{GE} = \pm 20\text{ V}$			$\pm 500$	nA
$C_{ies}$	Input capacitance	$V_{CE} = 25\text{ V}$ , $f = 1\text{ MHz}$ , $V_{GE} = 0\text{ V}$		4150		pF
$C_{oes}$	Output capacitance			170		pF
$C_{res}$	Reverse transfer capacitance			80		pF
$Q_g$	Total gate charge	$V_{CC} = 520\text{ V}$ , $I_C = 50\text{ A}$ , $V_{GE} = \pm 15\text{ V}$		150		nC
$t_{d(on)}$	Turn-on delay time	$V_{CC} = 300\text{ V}$ , $I_C = 50\text{ A}$ , $R_G = 6.8\ \Omega$ , $V_{GE} = \pm 15\text{ V}$ ,		143		ns
$t_r$	Current rise time			16.5		ns
$E_{on}^{(1)}$	Turn-on switching energy	$di/dt = 2400\text{ A}/\mu\text{s}$		0.140		mJ
$t_{d(off)}$	Turn-off delay time	$V_{CC} = 300\text{ V}$ , $I_C = 50\text{ A}$ , $R_G = 6.8\ \Omega$ , $V_{GE} = \pm 15\text{ V}$ ,		112		ns
$t_f$	Current fall time			149		ns
$E_{off}^{(2)}$	Turn-off switching energy		$dv/dt = 7600\text{ V}/\mu\text{s}$		1.45	

Symbol	Parameter	Test conditions	Min.	Typ.	Max.	Unit
$t_{d(on)}$	Turn-on delay time	$V_{CC} = 300\text{ V}$ , $I_C = 50\text{ A}$ ,		148		ns
$t_r$	Current rise time	$R_G = 6.8\ \Omega$ , $V_{GE} = \pm 15\text{ V}$ ,		19.2		ns
$E_{on(1)}$	Turn-on switching energy	$di/dt = 2062\text{ A}/\mu\text{s}$ , $T_J = 150\text{ }^\circ\text{C}$		0.311		mJ
$t_{d(off)}$	Turn-off delay time	$V_{CC} = 300\text{ V}$ , $I_C = 50\text{ A}$ ,		110		ns
$t_f$	Current fall time	$R_G = 6.8\ \Omega$ , $V_{GE} = \pm 15\text{ V}$ ,		221		ns
$E_{off(2)}$	Turn-off switching energy	$dv/dt = 5800\text{ V}/\mu\text{s}$ , $T_J = 150\text{ }^\circ\text{C}$		1.98		mJ
$t_{SC}$	Short-circuit withstand time	$V_{CC} \leq 360\text{ V}$ , $V_{GE} \leq 15\text{ V}$ , $T_{Jstart} \leq 150\text{ }^\circ\text{C}$	6			$\mu\text{s}$
$R_{THJ-c}$	Thermal resistance junction-to-case	Each IGBT		0.65	0.72	$^\circ\text{C}/\text{W}$
$R_{THC-h}$	Thermal resistance case-to-heatsink	Each IGBT, $\lambda_{grease} = 1\text{ W}/(\text{m}\cdot^\circ\text{C})$		0.79		$^\circ\text{C}/\text{W}$

1. Including the reverse recovery of the diode.
2. Including the tail of the collector current.

## 1.2 Diode

Limiting values at  $T_J = 25\text{ }^\circ\text{C}$ , unless otherwise specified.

**Table 3. Absolute maximum ratings of the diode**

Symbol	Parameter	Value	Unit
$V_{RRM}$	Repetitive peak reverse voltage	650	V
$I_F$	Continuous forward current at ( $T_C = 100\text{ }^\circ\text{C}$ )	50	A
$I_{FP(1)}$	Pulsed forward current ( $t_p = 1\text{ ms}$ )	100	A
$T_{JMAX}$	Maximum junction temperature	175	$^\circ\text{C}$
$T_{Jop}$	Operating junction temperature range under switching conditions	-40 to 150	$^\circ\text{C}$

1. Pulse width limited by maximum junction temperature.

**Table 4. Electrical characteristics of the diode**

Symbol	Parameter	Test conditions	Min.	Typ.	Max.	Unit
$V_F$ (terminal)	Forward voltage	$I_F = 50\text{ A}$	-	1.85	2.65	V
		$I_F = 50\text{ A}$ , $T_J = 150\text{ }^\circ\text{C}$	-	1.65		
$t_{rr}$	Reverse recovery time		-	142		ns
$Q_{rr}$	Reverse recovery charge	$I_F = 50\text{ A}$ , $V_R = 300\text{ V}$ ,	-	1.87		$\mu\text{C}$
$I_{rrm}$	Reverse recovery current	$V_{GE} = \pm 15\text{ V}$ , $di/dt = 2400\text{ A}/\mu\text{s}$	-	40		A
$E_{rec}$	Reverse recovery energy		-	0.41		mJ
$t_{rr}$	Reverse recovery time		-	260		ns
$Q_{rr}$	Reverse recovery charge	$I_F = 50\text{ A}$ , $V_R = 300\text{ V}$ ,	-	5.2		$\mu\text{C}$
$I_{rrm}$	Reverse recovery current	$V_{GE} = \pm 15\text{ V}$ , $di/dt = 2062\text{ A}/\mu\text{s}$ ,	-	58		A
$E_{rec}$	Reverse recovery energy	$T_J = 150\text{ }^\circ\text{C}$	-	1.32		mJ

Symbol	Parameter	Test conditions	Min.	Typ.	Max.	Unit
$R_{THj-c}$	Thermal resistance junction-to-case	Each diode	-	1.0	1.1	°C/W
$R_{THc-h}$	Thermal resistance case-to-heatsink	Each diode, $\lambda_{grease} = 1 \text{ W/(m}\cdot\text{°C)}$	-	0.9		°C/W

### 1.3 NTC

**Table 5. NTC temperature sensor, considered as stand-alone**

Symbol	Parameter	Test conditions	Min.	Typ.	Max.	Unit
$R_{25}$	Resistance	$T = 25^\circ\text{C}$		5		k $\Omega$
$R_{100}$	Resistance	$T = 100^\circ\text{C}$		493		$\Omega$
$\Delta R/R$	Deviation of $R_{100}$		-5		+5	%
$B_{25/50}$	B-constant			3375		K
$B_{25/80}$	B-constant			3411		K
T	Operating temperature range		-40		150	°C

**Figure 1. NTC resistance vs temperature**

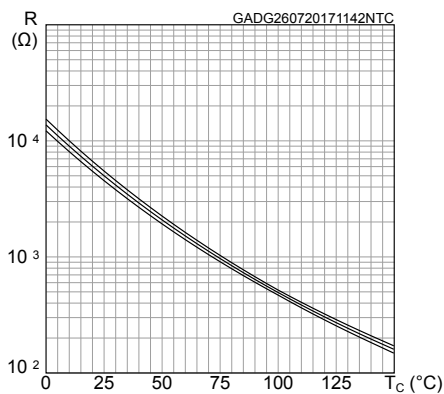

**Figure 2. NTC resistance vs temperature, zoom**

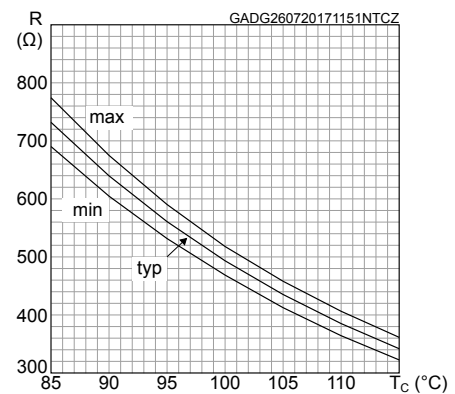

### 1.4 Package

**Table 6. ACEPACK™ 1 package**

Symbol	Parameter	Min.	Typ.	Max.	Unit
$V_{isol}$	Isolation voltage (AC voltage, $t = 60 \text{ s}$ )			2500	Vrms
$T_{stg}$	Storage temperature	-40		125	°C
CTI	Comparative tracking index	200			
$L_s$	Stray inductance module P1 - EW loop		28.7		nH
$R_s$	Module single lead resistance, terminal-to-chip		3.9		m $\Omega$

## 2 Electrical characteristics (curves)

**Figure 3. IGBT output characteristics**  
( $V_{GE} = 15\text{ V}$ , terminal)

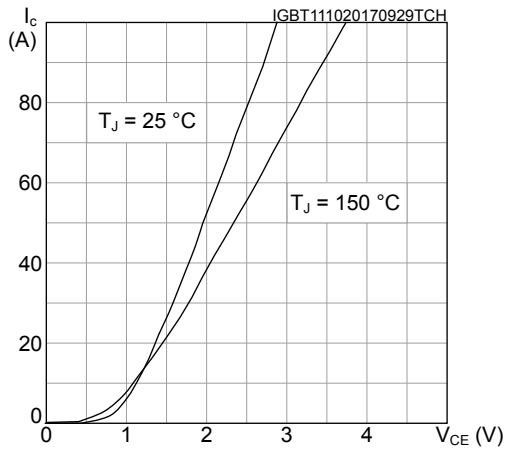

**Figure 4. IGBT output characteristics**  
( $T_J = 150\text{ °C}$ , terminal)

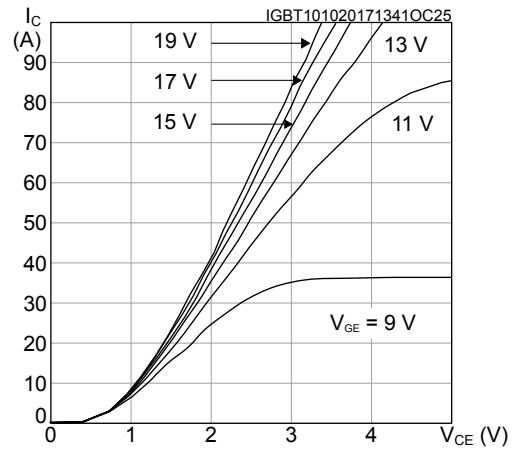

**Figure 5. IGBT transfer characteristics**  
( $V_{CE} = 15\text{ V}$ , terminal)

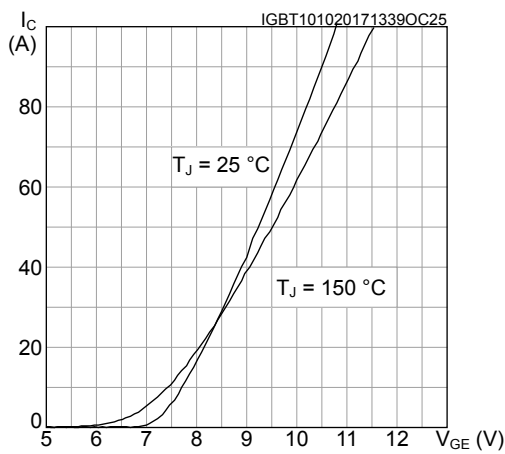

**Figure 6. IGBT collector current vs case temperature**

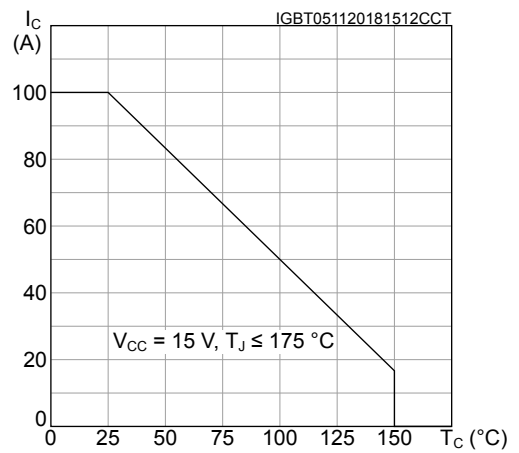

**Figure 7. Switching energy vs gate resistance**

**Figure 8. Switching energy vs collector current**

**Figure 9. IGBT reverse biased safe operating area (RBSOA)**

**Figure 10. Diode forward characteristics**

**Figure 11. Diode reverse recovery energy vs diode current slope**

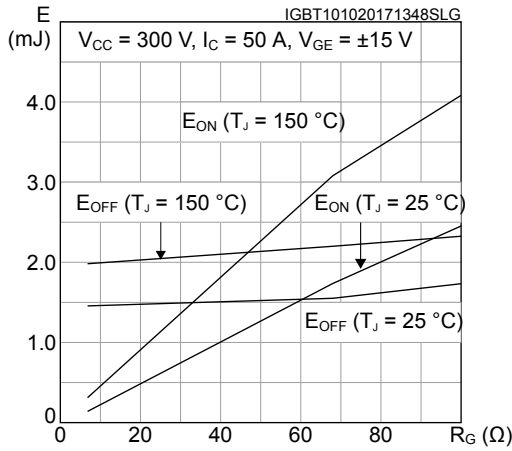
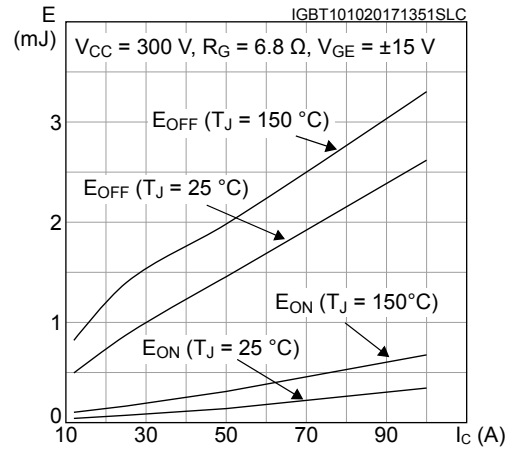
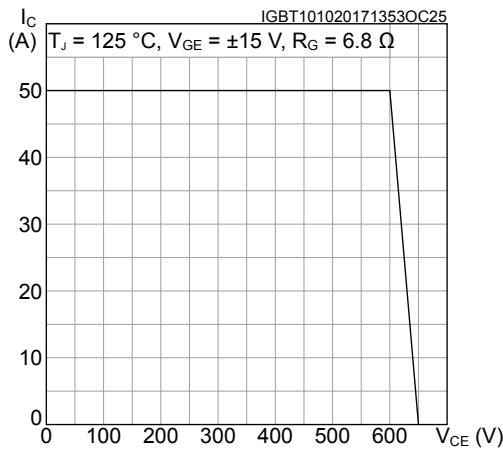
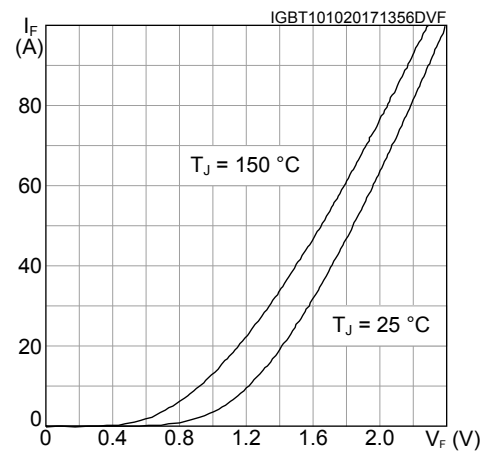
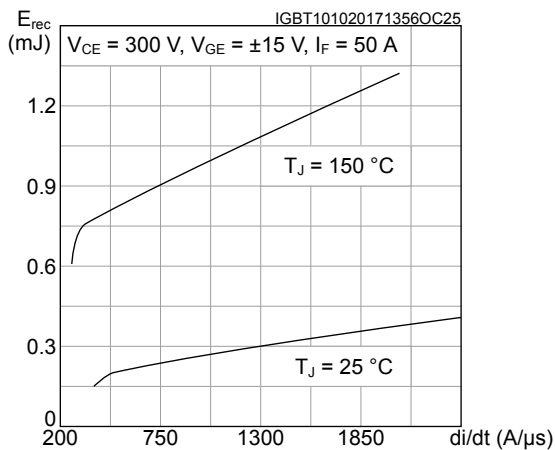
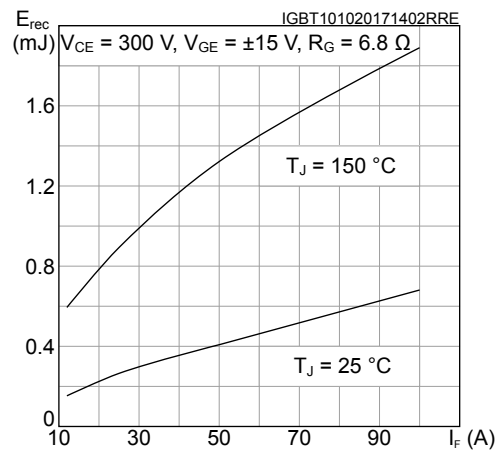
**Figure 12. Diode reverse recovery energy vs forward current**

Figure 13. Diode reverse recovery energy vs gate resistance

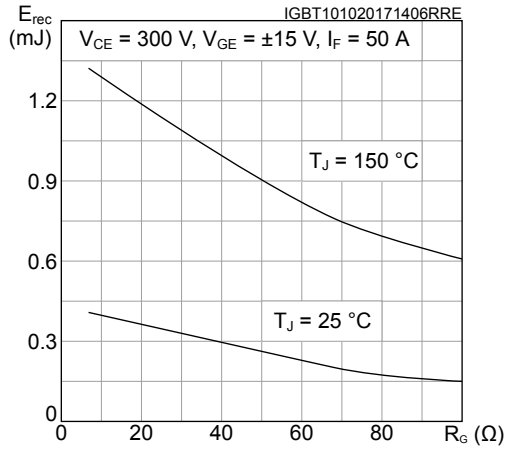

Figure 14. Inverter diode thermal impedance

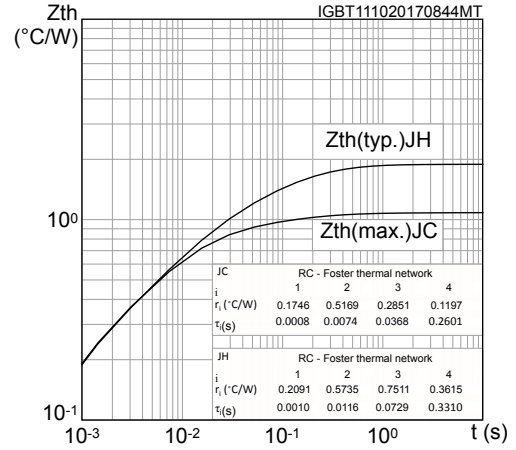
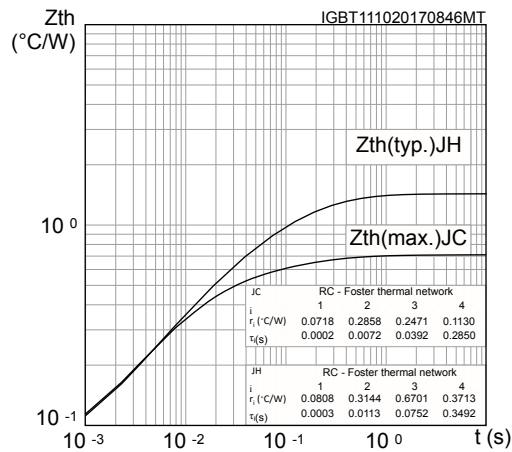
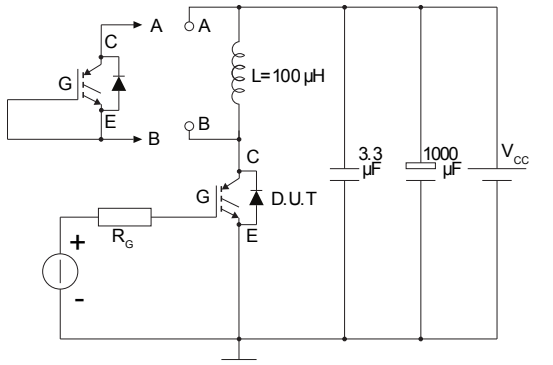
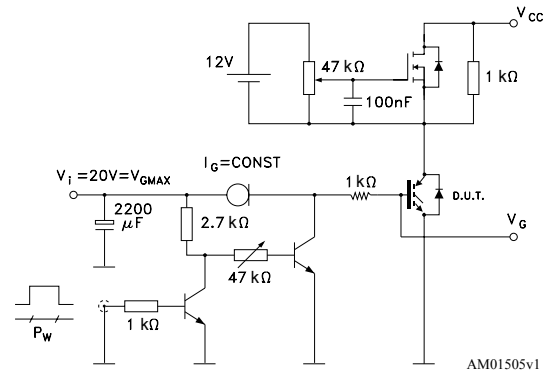
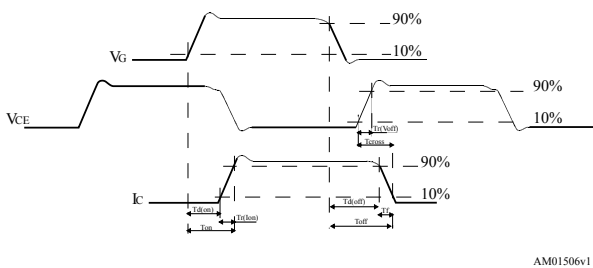
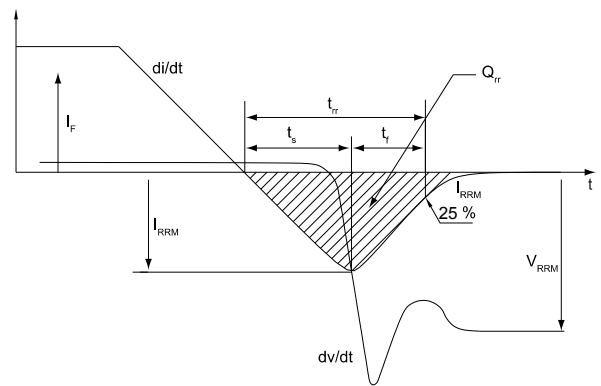

Figure 15. IGBT thermal impedance



### 3 Test circuits

**Figure 16. Test circuit for inductive load switching**

**Figure 17. Gate charge test circuit**

**Figure 18. Switching waveform**

**Figure 19. Diode reverse recovery waveform**



## 4 Topology and pin description

Figure 20. Electrical topology and pin description

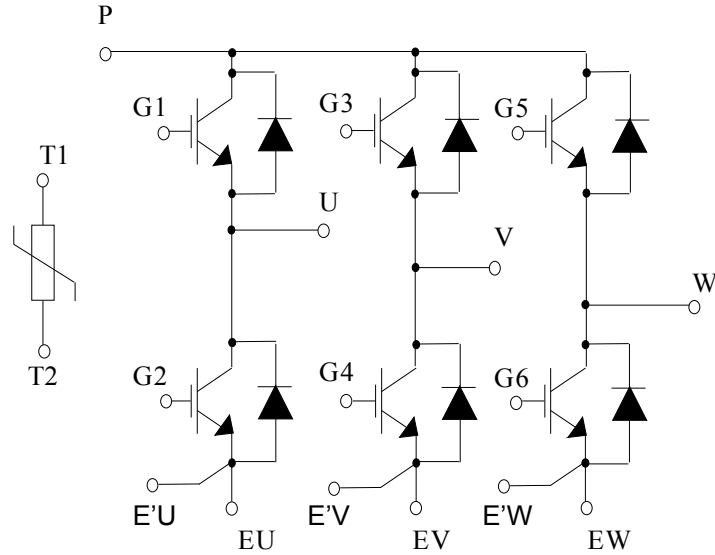
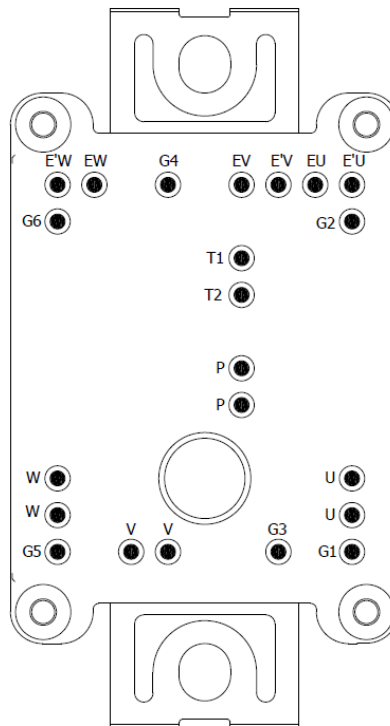

Figure 21. Package top view with sixpack pinout



## **5**      **Package information**

---

In order to meet environmental requirements, ST offers these devices in different grades of **ECOPACK®** packages, depending on their level of environmental compliance. ECOPACK® specifications, grade definitions and product status are available at: [www.st.com](http://www.st.com). ECOPACK® is an ST trademark.

## 5.1 ACEPACK™ 1 sixpack solder pins package information

Figure 22. ACEPACK™ 1 sixpack solder pins package outline (dimensions are in mm)

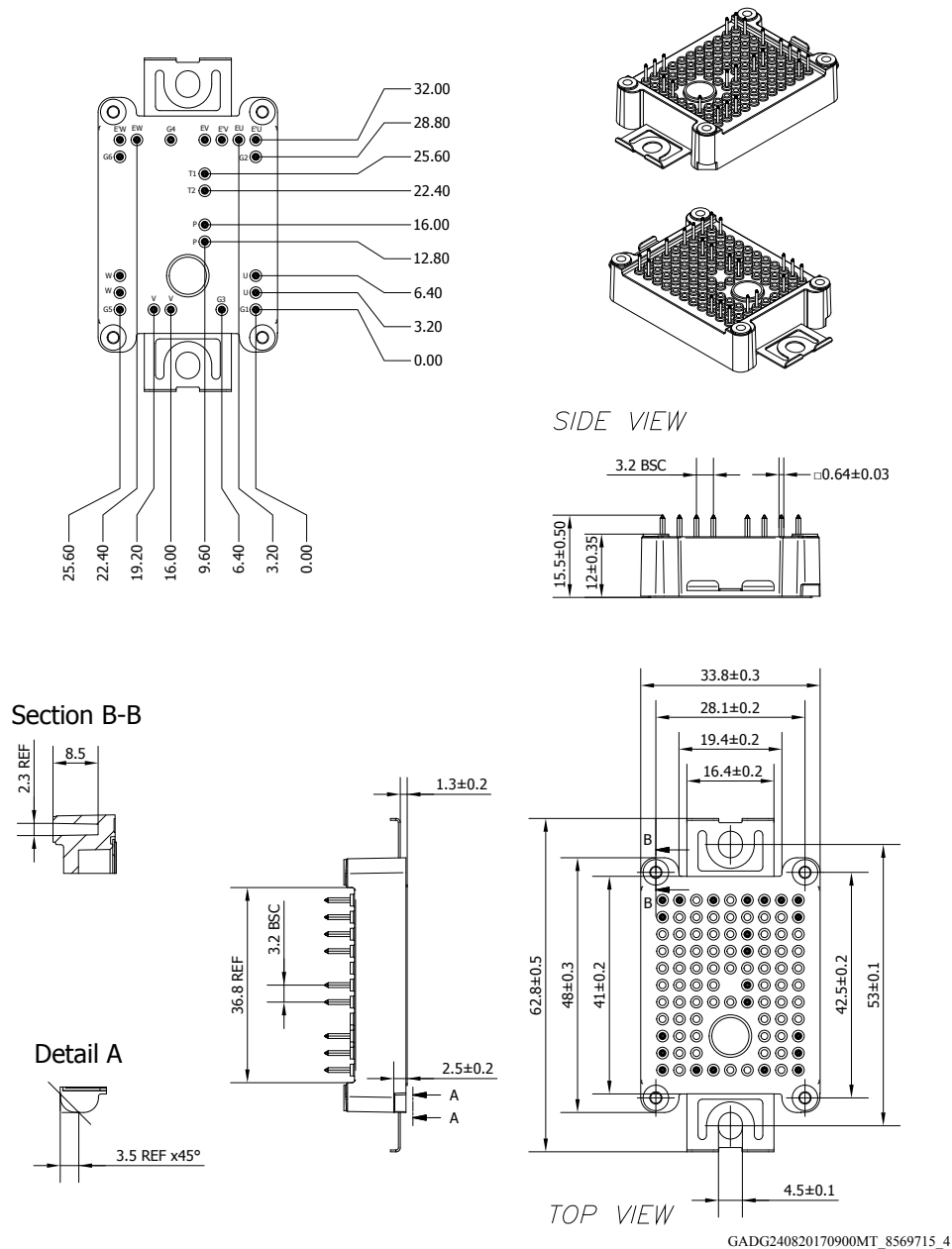

- The lead size includes the thickness of the lead plating material.
- Dimensions do not include mold protrusion.
- Package dimensions do not include any eventual metal burrs.

## Revision history

**Table 7. Document revision history**

Date	Revision	Changes
11-Oct-2017	1	Initial release.
16-Feb-2018	2	<p>Updated features and removed maturity status indication from cover page.</p> <p>Updated <i>Figure 13. Inverter diode thermal impedance</i> and <i>Figure 14. IGBT thermal impedance</i>.</p> <p>Updated <i>Figure 21. ACEPACK™ 1 sixpack solder pins package outline (dimensions are in mm)</i>.</p> <p>Minor text changes</p>
14-Nov-2018	3	<p>Added <a href="#">Figure 6. IGBT collector current vs case temperature</a>.</p> <p>Minor text changes</p>

## Contents

<b>1</b>	<b>Electrical ratings</b> .....	<b>2</b>
1.1	IGBT .....	2
1.2	Diode .....	3
1.3	NTC.....	4
1.4	Package .....	4
<b>2</b>	<b>Electrical characteristics (curves)</b> .....	<b>5</b>
<b>3</b>	<b>Test circuits</b> .....	<b>8</b>
<b>4</b>	<b>Topology and pin description</b> .....	<b>9</b>
<b>5</b>	<b>Package information</b> .....	<b>10</b>
5.1	ACEPACK™ 1 sixpack solder pins package information .....	11
	<b>Revision history</b> .....	<b>12</b>

**IMPORTANT NOTICE – PLEASE READ CAREFULLY**

STMicroelectronics NV and its subsidiaries (“ST”) reserve the right to make changes, corrections, enhancements, modifications, and improvements to ST products and/or to this document at any time without notice. Purchasers should obtain the latest relevant information on ST products before placing orders. ST products are sold pursuant to ST’s terms and conditions of sale in place at the time of order acknowledgement.

Purchasers are solely responsible for the choice, selection, and use of ST products and ST assumes no liability for application assistance or the design of Purchasers’ products.

No license, express or implied, to any intellectual property right is granted by ST herein.

Resale of ST products with provisions different from the information set forth herein shall void any warranty granted by ST for such product.

ST and the ST logo are trademarks of ST. All other product or service names are the property of their respective owners.

Information in this document supersedes and replaces information previously supplied in any prior versions of this document.

© 2018 STMicroelectronics – All rights reserved

Компания «Life Electronics» занимается поставками электронных компонентов импортного и отечественного производства от производителей и со складов крупных дистрибьюторов Европы, Америки и Азии.

С конца 2013 года компания активно расширяет линейку поставок компонентов по направлению коаксиальный кабель, кварцевые генераторы и конденсаторы (керамические, пленочные, электролитические), за счёт заключения дистрибьюторских договоров

Мы предлагаем:

- Конкуренеспособные цены и скидки постоянным клиентам.
- Специальные условия для постоянных клиентов.
- Подбор аналогов.
- Поставку компонентов в любых объемах, удовлетворяющих вашим потребностям.
- Приемлемые сроки поставки, возможна ускоренная поставка.
- Доставку товара в любую точку России и стран СНГ.
- Комплексную поставку.
- Работу по проектам и поставку образцов.
- Формирование склада под заказчика.
- Сертификаты соответствия на поставляемую продукцию (по желанию клиента).
- Тестирование поставляемой продукции.
- Поставку компонентов, требующих военную и космическую приемку.
- Входной контроль качества.
- Наличие сертификата ISO.

В составе нашей компании организован Конструкторский отдел, призванный помогать разработчикам, и инженерам.

Конструкторский отдел помогает осуществить:

- Регистрацию проекта у производителя компонентов.
- Техническую поддержку проекта.
- Защиту от снятия компонента с производства.
- Оценку стоимости проекта по компонентам.
- Изготовление тестовой платы монтаж и пусконаладочные работы.



Тел: +7 (812) 336 43 04 (многоканальный)

Email: [org@lifeelectronics.ru](mailto:org@lifeelectronics.ru)