

FCT

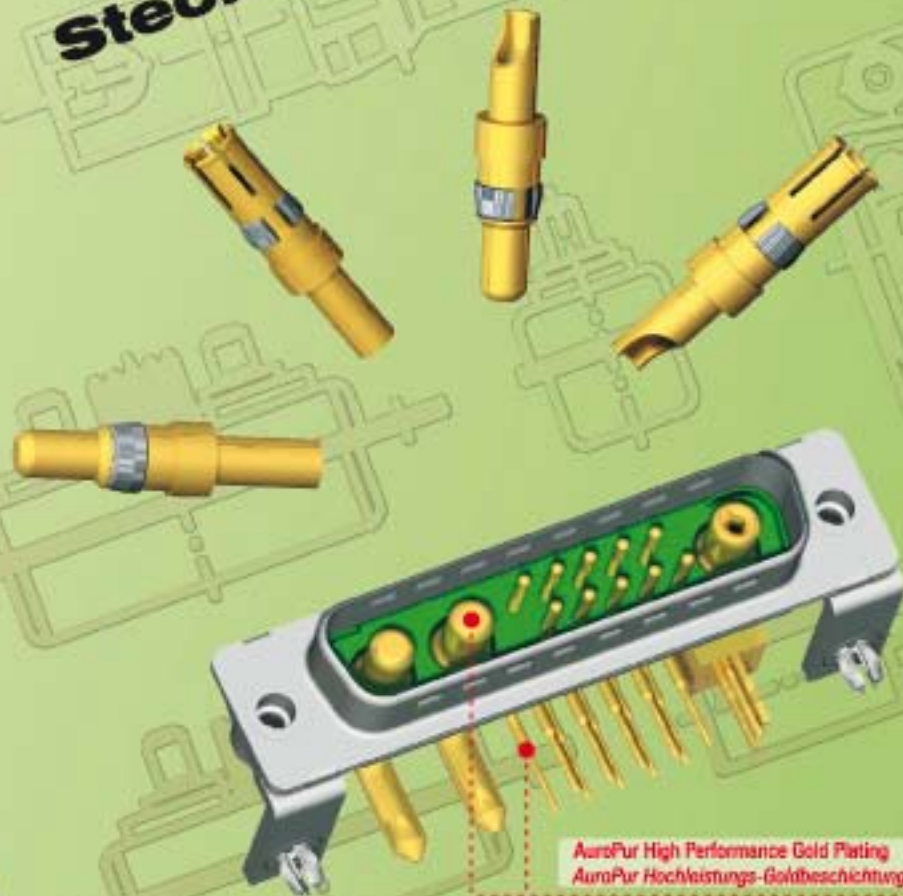

**D-Sub
Mixed Layout
Connectors**

**D-Sub
Mixed Layout
Steckverbinder**



Catalogue No.:
Katalog Nr.:
ML 12/2008.3000

Dual language content: English text first in black, German text second in light-blue italics

<http://fctgroup.com>



All Products are RoHS compliant. A summary of all products and possible exceptions can be found on our internet site www.fctgroup.com, menu item RoHS product summary.

Alle Erzeugnisse sind RoHS konform. Eine Übersicht über alle Erzeugnisse und eventuelle Ausnahmen finden Sie auf unserer Internetseite www.fctgroup.com, Menüpunkt RoHS Artikelübersicht

The front page illustration is an exploded view of a D-Sub Mixed Layout connector:

- With tin plated connector shell and dimples
- With a glass fibre reinforced polyester insulator (FM)
- Contact arrangement 13W3
- 10 right angled signal pin contacts P5
- 2 metal brackets F1080-13B
- 2 snap-in rivets for PCB thickness 1.6 mm (0.063 ")
- 2 clinch nuts with thread 4-40 UNC
- 2 right angled high power pin contacts with maximum 20 Amp current rating
- 1 coaxial plug (50 ohm) with right angled PCB termination

Connector order number: FM13W3P5-0212
High power contacts order number: FMP008P104
Coaxial contact order number: FME008P102

Die Titelseite zeigt einen D-Sub Mixed Layout Steckverbinder in Übersichtsdarstellung:

- *mit verzinnem Stiftsteckverbindergehäuse und Kontaktnoppen*
- *glasfaserverstärktem Polyesterisoliertkörper (FM)*
- *Polbild 13W3*
- *10 rechtwinklige Stiftkontakte P5*
- *2 Metallwinkel F1080-13B*
- *2 Snap-in Niet für 1,6 mm Leiterplattenstärke*
- *2 Einnietmutter mit 4-40 UNC Gewinde*
- *2 abgewinkelte Hochstromstiftkontakte bis max. 20 A*
- *1 Koaxialstiftkontakt (50 Ohm) mit abgewinkeltem Leiterplattenanschluss*

Bestellnummer Steckverbinder: FM13W3P5-0212
Bestellnummer Hochstromkontakt: FMP008P104
Bestellnummer Koaxialkontakt: FME008P102

Please Note

We accept no responsibility for the rights of third parties with regards to any of the herein printed tables or descriptions. With this catalogue components are illustrated, features are not guaranteed. Availability and technical alterations are subject to change without prior warning. We accept no responsibility for human error or misprints within this catalogue. We offer no guarantee for the completeness of any herein printed reports. Reproduction of this catalogue and utilization of its contents are prohibited, unless otherwise expressly stated!

December 2008 © FCT

Anmerkung

Für die angegebenen Beschreibungen und Tabellen wird keine Gewähr bezüglich der Freiheit und Rechten Dritter übernommen. Mit den Angaben werden die Bauelemente spezifiziert, nicht Eigenschaften zugesichert. Liefermöglichkeiten und technische Änderungen ohne Vorankündigung, Irrtum und Druckfehler vorbehalten. Für die Abhandlungen kann keine Garantie auf Vollständigkeit übernommen werden. Vervielfältigung dieser Unterlage sowie Verwertung ihres Inhalts sind unzulässig, soweit nicht ausdrücklich zugestanden!

Dezember 2008 © FCT

List of Contents





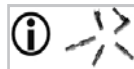
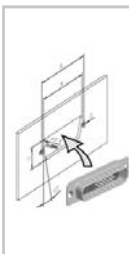















Inhaltsverzeichnis

D-Sub Mixed Layout Connectors	7
<i>D-Sub Mixed Layout Steckverbinder</i>	<i>7</i>
Ordering Code	7
<i>Bestellschlüssel</i>	<i>7</i>
Technical Data, FM Connectors.....	8
<i>Technische Daten, FM Steckverbinder</i>	<i>8</i>
AuroPur High Performance Gold Plating	9
<i>AuroPur Hochleistungs-Goldbeschichtung</i>	<i>9</i>
Test Report, Derating Diagram.....	10
<i>Testbericht, Diagramm Strombelastbarkeit</i>	<i>10</i>
Contact Arrangements (FM-Series with Mounted Signal Contacts).....	11
<i>Polbilder (FM-Baureihe, mit fest eingebauten Signalkontakten)</i>	<i>11</i>
Contact Arrangements (FU/FL Series, for Crimp Signal Contacts).....	12
<i>Polbilder (FU/FL Baureihe, für Crimp-Signalkontakte)</i>	<i>12</i>
Panel Cut-out.....	13
<i>Montageausschnitt</i>	<i>13</i>
Mounting and Mating Instructions (According to DIN 41652 T1).....	14
<i>Montage- und Stechhinweise (nach DIN 41652 T1)</i>	<i>14</i>
Earthing Methods	14
<i>Masseanschlussvarianten</i>	<i>14</i>
Shell Dimensions, FM Connectors.....	15
<i>Gehäuseabmessungen, FM Steckverbinder</i>	<i>15</i>
Straight Signal Contacts.....	16
<i>Gerade Signalkontakte</i>	<i>16</i>
Mixed Layout Connector with Accessories	17
<i>Mixed Layout Steckverbinder mit Anbauteilen</i>	<i>17</i>
Right Angled Signal Contacts.....	18
<i>Abgewinkelte Signalkontakte</i>	<i>18</i>
Mixed Layout Connector with Plastic Brackets FKA1/4 and Accessories	20
<i>Mixed Layout Steckverbinder mit Kunststoffwinkel FKA1/4 und Anbauteilen</i>	<i>20</i>
Mixed Layout Connector with Metal Brackets F1080-... and Accessories	21
<i>Mixed Layout Steckverbinder mit Metallwinkel F1080-... und Anbauteilen</i>	<i>21</i>
Crimp Connectors.....	22
<i>Crimp Steckverbinder</i>	<i>22</i>
Turned Contacts for Crimp Connectors	24
<i>Gedrehte Kontakte für Crimp Steckverbinder</i>	<i>24</i>
General Information on Special Contacts for Mixed Layout Connectors	25
<i>Allgemeine Informationen über Sonderkontakte für Mixed Layout Steckverbinder</i>	<i>25</i>
Code for Special Contacts	26
<i>Nummernschlüssel für Sonderkontakte</i>	<i>26</i>
Ordering Code	26
<i>Bestellschlüssel</i>	<i>26</i>
Series.....	26
<i>Baureihen</i>	<i>26</i>
Modifications	26
<i>Modifikationen</i>	<i>26</i>
Plating Specifications for the Series FMX, FMS, FME and FBM.....	27
<i>Oberflächenspezifikationen für die Baureihen FMX, FMS, FME und FBM</i>	<i>27</i>
Plating Specifications (High Power Contacts)	27
<i>Oberflächenspezifikationen (Hochstromkontakte)</i>	<i>27</i>
Wire Cross-section	27
<i>Leiterquerschnitt</i>	<i>27</i>





List of Contents

Inhaltsverzeichnis

	Coaxial Contacts	28	
	<i>Koaxialkontakte</i>	28	
	Technical Data	28	
	<i>Technische Daten</i>	28	
	VSWR Measurements (Examples)	29	
	<i>VSWR Messungen (Beispiele)</i>	29	
	Coaxial Contacts, Mating Area Dimensions, Pin Diameter 1 mm (0.039")	30	
	<i>Koaxialkontakte, Abmessungen Steckbereich, Pindurchmesser 1 mm</i>	30	
FMX	FMX Coaxial Contacts, 50 Ohm, Straight Cable Termination	31	
	<i>FMX Koaxialkontakte, 50 Ohm, gerader Kabelanschluss</i>	31	
	FMX Coaxial Contacts, 50 Ohm, Right Angled Cable Termination	32	
	<i>FMX Koaxialkontakte, 50 Ohm, abgewinkelter Kabelanschluss</i>	32	
	FMX Coaxial Contacts, 75 Ohm, Straight Cable Termination	33	
	<i>FMX Koaxialkontakte, 75 Ohm, gerader Kabelanschluss</i>	33	
FMS	FMS Coaxial Contacts, 50 Ohm, Straight Cable Termination	34	
	<i>FMS Koaxialkontakte, 50 Ohm, gerader Kabelanschluss</i>	34	
	FMS Coaxial Contacts, 50 Ohm, Right Angled Cable Termination	35	
	<i>FMS Koaxialkontakte, 50 Ohm, abgewinkelter Kabelanschluss</i>	35	
	FMS Coaxial Contacts, 75 Ohm, Straight Cable Termination	36	
	<i>FMS Koaxialkontakte, 75 Ohm, gerader Kabelanschluss</i>	36	
	FMS Coaxial Contacts, 75 Ohm, Right Angled Cable Termination	37	
	<i>FMS Koaxialkontakte, 75 Ohm, abgewinkelter Kabelanschluss</i>	37	
	Coaxial Contacts, Mating Area Dimensions, Pin Diameter 0.75 mm (0.030")	38	
	<i>Koaxialkontakte, Abmessungen Steckbereich, Pindurchmesser 0,75 mm</i>	38	
	FMS Coaxial Contacts, 50 Ohm, Straight Cable Termination, Pin Diameter 0.75 mm (0.030")	39	
	<i>FMS Koaxialkontakte, 50 Ohm, gerader Kabelanschluss, Pindurchmesser 0,75 mm</i>	39	
	FMX Coaxial Contacts, 50 Ohm, Straight Cable Termination, Pin Diameter 0.75 mm (0.030")	39	
	<i>FMX Koaxialkontakte, 50 Ohm, gerader Kabelanschluss, Pindurchmesser 0,75 mm</i>	39	
	Wiresplice	40	
	<i>Wiresplice</i>	40	
		Discontinued 3- Qrt 2009	
		abgekündigt 3- Quartal 2009	
FME	FME Coaxial Contacts, 50 Ohm, Straight PCB Termination, 3 Pins	41	
	<i>FME Koaxialkontakte, 50 Ohm, gerader Leiterplattenanschluss, 3 Anschlüsse</i>	41	
	FME Coaxial Contacts, 50 Ohm, Right Angled PCB Termination, 3 Pins	42	
	<i>FME Koaxialkontakte, 50 Ohm, abgewinkelter Leiterplattenanschluss, 3 Anschlüsse</i>	42	
	FME Coaxial Contacts, 50 Ohm, Right Angled PCB Termination, 5 Pins	43	
	<i>FME Koaxialkontakte, 50 Ohm, abgewinkelter Leiterplattenanschluss, 5 Anschlüsse</i>	43	
	FME Coaxial Contacts, 75 Ohm, Straight PCB Termination, 3 Pins	44	
	<i>FME Koaxialkontakte, 75 Ohm, gerader Leiterplattenanschluss, 3 Anschlüsse</i>	44	
	FME Coaxial Contacts, 75 Ohm, Right Angled PCB Termination, 3 Pins	45	
	<i>FME Koaxialkontakte, 75 Ohm, abgewinkelter Leiterplattenanschluss, 3 Anschlüsse</i>	45	
	FME Coaxial Contacts, 75 Ohm, Right Angled PCB Termination, 5 Pins	46	
	<i>FME Koaxialkontakte, 75 Ohm, abgewinkelter Leiterplattenanschluss, 5 Anschlüsse</i>	46	
	PCB Hole Pattern for Connectors with Straight PCB Terminations	47	
	<i>Leiterplattenlochbild für Steckverbinder mit geradem Leiterplattenanschluss</i>	47	
	PCB Hole Pattern for Connectors with Right Angled PCB Terminations	52	
	<i>Leiterplattenlochbild für Steckverbinder mit abgewinkelterm Leiterplattenanschluss</i>	52	

List of Contents

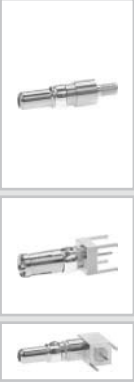
Inhaltsverzeichnis

FBM	FBM Coaxial Contacts, Mating Area Dimensions 58 <i>FBM Koaxialkontakte, Abmessungen Steckbereich</i> 58			
	FBM Coaxial Contacts, 50 Ohm, Straight Cable Termination 59 <i>FBM Koaxialkontakte, 50 Ohm, gerader Kabelanschluss</i> 59			
	FBM Coaxial Contacts, 50 Ohm, Straight Semi Rigid Cable Termination 60 <i>FBM Koaxialkontakte, 50 Ohm, gerader semi rigid Kabelanschluss</i> 60			
	FBM Coaxial Contacts, 50 Ohm, Straight PCB Termination, 3 Pins 61 <i>FBM Koaxialkontakte, 50 Ohm, gerader Leiterplattenanschluss, 3 Anschlüsse</i> 61			
	FBM Coaxial Contacts, 50 Ohm, Straight PCB Termination, 5 Pins 62 <i>FBM Koaxialkontakte, 50 Ohm, gerader Leiterplattenanschluss, 5 Anschlüsse</i> 62			
	FBM Coaxial Contacts, 50 Ohm, Right Angled PCB Termination, 3 Pins 63 <i>FBM Koaxialkontakte, 50 Ohm, abgewinkelter Leiterplattenanschluss, 3 Anschlüsse</i> 63			
High Power Contacts 64 <i>Hochstromkontakte</i> 64				
FMP	Technical Data 64 <i>Technische Daten</i> 64			
	High Power Contacts, Mating Area Dimensions 65 <i>Hochstromkontakte, Abmessungen Steckbereich</i> 65			
	High Power Contacts, Straight Cable Termination, Solder 66 <i>Hochstromkontakte, gerader Kabelanschluss, Löten</i> 66			
	High Power Contacts, Straight Cable Termination, Crimp 67 <i>Hochstromkontakte, gerader Kabelanschluss, Crimpen</i> 67			
	High Power Contacts, Straight PCB Termination 68 <i>Hochstromkontakte, gerader Leiterplattenanschluss</i> 68			
	High Power Contacts, Right Angled PCB Termination 69 <i>Hochstromkontakte, abgewinkelter Leiterplattenanschluss</i> 69			
	High Power Contacts, Straight PCB Termination with Flexible Press-fit 70 <i>Hochstromkontakte, gerader Leiterplattenanschluss mit flexibler Einpresszone</i> 70			
	High Power Contacts, Right Angled PCB Termination with Flexible Press-fit 71 <i>Hochstromkontakte, abgewinkelter Leiterplattenanschluss mit flexibler Einpresszone</i> 71			
	High Power Contacts, Early Make Late Break, Ø 2.7 mm (Ø 0.106") 71 <i>Hochstromkontakte, Early make Late break, Ø 2,7 mm</i> 71			
	Connectors with High Power Contacts with Semi Flexible Press-fit 72 <i>Steckverbinder mit Hochstromkontakten mit semiflexibler Einpresszone</i> 72			
	PCB Hole Pattern for Connectors with Straight PCB Terminations 73 <i>Leiterplattenlochbild für Steckverbinder mit geradem Leiterplattenanschluss</i> 73			
	PCB Hole Pattern for Connectors with Right Angled PCB Terminations 78 <i>Leiterplattenlochbild für Steckverbinder mit abgewinkeltm Leiterplattenanschluss</i> 78			
	D-Sub Mixed Layout Filter Connectors with High Power Contacts 83 <i>D-Sub Mixed Layout Filtersteckverbinder mit Hochstromkontakten</i> 83			
	High Voltage Contacts 84 <i>Hochspannungskontakte</i> 84			
	FMV		Technical Data 84 <i>Technische Daten</i> 84	
High Voltage Contacts, Straight Cable Termination, Solder 85 <i>Hochspannungskontakte, gerader Kabelanschluss, Löten</i> 85				
High Voltage Contacts, Right Angled Cable Termination, Solder 85 <i>Hochspannungskontakte, abgewinkelter Kabelanschluss, Löten</i> 85				
High Voltage Contacts, Straight PCB 86 <i>Hochspannungskontakte, gerader Leiterplattenanschluss</i> 86				
High Voltage Contacts, Straight Cable Termination, Crimp 86 <i>Hochspannungskontakte, gerader Kabelanschluss, Crimpen</i> 86				

List of Contents

Inhaltsverzeichnis

	Pneumatic Contacts 87	
	<i>Pneumatikkontakte</i> 87	
FMG	Technical Data 87	
	<i>Technische Daten</i> 87	
	Dimensions 88	
	<i>Abmessungen</i> 88	
	Special Series 89	
	<i>Sondervarianten</i> 89	
	Mixed Layout Connectors in Waterproof Version (IP67) 89	
	<i>Mixed Layout Steckverbinder in wasserdichter Ausführung (IP67)</i> 89	
	Overview Nonmagnetic Products 91	
	<i>Übersicht nonmagnetische Produkte</i> 91	
	General Information on Crimp Connections 92	
	<i>Allgemeine Informationen über Crimpverbindungen</i> 92	
	Features 92	
	<i>Merkmale</i> 92	
	Processing 93	
	<i>Verarbeitung</i> 93	
	Tools 94	
	<i>Werkzeuge</i> 94	
	Crimping Tools for Coaxial Contacts without Crimp Snap-in 94	
	<i>Crimpwerkzeuge für Koaxialkontakte ohne Crimp Snap-In</i> 94	
	Crimping Tools for Coaxial Contacts with Crimp Snap-in 94	
	<i>Crimpwerkzeuge für Koaxialkontakte mit Crimp Snap-In</i> 94	
	Crimping Tools for Wiresplice 95	
	<i>Crimpwerkzeuge für Wiresplice</i> 95	
	Crimping Tools for High Power Contacts 95	
	<i>Crimpwerkzeuge für Hochstromkontakte</i> 95	
	Crimping Tools 96	
	<i>Crimpwerkzeuge</i> 96	
	Insertion and Extraction Tools 97	
	<i>Ein- und Ausbauwerkzeug</i> 97	
	Accessories 98	
	<i>Zubehör</i> 98	
	Sealing Plugs 98	
	<i>Blindstopfen</i> 98	
	Guide Pins 98	
	<i>Zentrierstifte</i> 98	
	General Information on the Construction of Mixed Layout Connectors 100	
	<i>Allgemeine Informationen zum Aufbau Mixed Layout Steckverbinder</i> 100	
	Order Number Index 101	
	<i>Bestellnummernindex</i> 101	

D-Sub Mixed Layout Connectors

D-Sub Mixed Layout Steckverbinder

Ordering Code

Bestellschlüssel

UL Recognized File No. 168813



F M W 17W2 S 5 A R - ...

Series prefix / *Serienbezeichnung*

Insulator / *Isolierkörper*

- Special type F1W1, F2W2...C, F3W3...C and F7W7 with black insulator
Sondertypen F1W1, F2W2...C, F3W3...C und F7W7 mit schwarzem Isolierkörper
- M** Polyester glass filled, UL94V-0
Glasfaserverstärkter Polyester, UL94V-0
- U** Polyetherimide glass filled, UL94V-0, with removable crimp signal contacts
Polyetherimid, glasfaserverstärkt, UL94V-0; mit ein- und ausbaubaren Crimp-Signalkontakten
- L** Polyamide glass filled, UL94V-0, without signal contacts (low cost version)
Polyamid, glasfaserverstärkt, UL94V-0; ohne Signalkontakte (Low Cost Version)
- H** Heat resistant, UL94V-0, please check the availability
Hochtemperaturbeständig, UL94V-0, Liefermöglichkeiten auf Anfrage

Mounting types / *Befestigungsarten*

- Standard / *Standard*
- W** Float mounted (see page 13) / *Schwimmend (siehe Seite 13)*
- T** Clinch nut 4-40 UNC (see page 13) / *Einnietmutter 4-40 UNC (siehe Seite 13)*
- Z** Clinch nut M3 (see page 13) / *Einnietmutter M3 (siehe Seite 13)*
- TS** Clinch nut 4-40 UNC, self locking (see page 13)
Einnietmutter 4-40 UNC, selbstsichernd (siehe Seite 13)
- ZS** Clinch nut M3, self locking (see page 13) / *Einnietmutter M3, selbstsichernd (siehe Seite 13)*

Contact arrangement (see pages 11 - 12) / *Polbild (siehe Seite 11 - 12)*

Contact type / *Kontaktart*

- P** Pin contacts / *Stiftkontakte*
- S** Socket contacts / *Buchsenkontakte*

Contact design (z. B. / e.g.) / *Kontaktvariante*

- Solder pot / *Löttopf*
- 1** Straight PCB termination Ø 0.6 mm (0.024") / *Leiterplattenanschluss, gerade Ø 0,6 mm*
- 2** Straight PCB termination Ø 0.76 mm (0.030") / *Leiterplattenanschluss, gerade Ø 0,76 mm*
- 4** Wire Wrap, length 12.7 mm (0.500") / *Wire Wrap, Länge 12,7 mm*
- 5** Right angled PCB termination Ø 0.6 mm (0.024") spacing 2.54 mm (0.100")
Leiterplattenanschluss, abgewinkelt Ø 0,6 mm, Reihenabstand 2,54 mm
- 7** Crimp contacts AWG 20 for FU and FL series (see page 24)
Crimpkontakte AWG 20 für FU und FL Baureihe (siehe Seite 24)

For more contacts see page 15 onwards / *Weitere Kontakte siehe Seite 16 ff.*

Plating for signal contacts / *Beschichtung Signalkontakte*

- A** Standard AuroPur (see page 9) / *Standard AuroPur (siehe Seite 9)*
- Au over Ni / *Au über Ni*

Direction of right angled contacts / *Richtung der abgewinkelten Kontakte*

- Standard / *Standard*
- R** Reverse / *Revers*

Modifications / *Modifikationen*

- K120** Shell tin plated over nickel, pin connector shell with dimples (standard)
Gehäuseoberfläche verzinkt über Nickel, Stiftsteckverbindergehäuse mit Kontaktnoppen (Standard)
- K121** Shell tin plated over nickel, socket connector shell without dimples (standard)
Gehäuseoberfläche verzinkt über Nickel, Buchsensteckverbindergehäuse ohne Kontaktnoppen (Standard)
- ...** FCT-connectors can be supplied with different accessories. For an overview, please see pages 17, 20 and 21.
To order connectors with accessories, please ask us!
*FCT-Steckverbinder sind mit verschiedenem Zubehör lieferbar. Eine Übersicht finden Sie auf den Seiten 17, 20 und 21.
Zur Bestellung von Steckverbindern mit Anbauteilen fragen Sie uns!*



Technical Data, FM Connectors

Technische Daten, FM Steckverbinder

Signal Contact Mechanical Data

Mechanische Daten der Signalkontakte

Mechanical Data <i>Mechanische Daten</i>	
Mating force per signal contact <i>Steckkraft pro Signalkontakt</i>	≤ 3,4 N
Unmating force per signal contact <i>Ziehkraft pro Signalkontakt</i>	≥ 0,2 N
Mating cycles <i>Steckzyklen</i>	≥ 500

Connector Electrical Data

Elektrische Daten der Steckverbinder

Electrical Data <i>Elektrische Daten</i>	
Current rating (DC with an ambient temperature of 20°C) <i>Maximale Stromstärke (DC bei 20°C Umgebungstemperatur)</i>	5 A
Test voltage between 2 contacts or shell and contact <i>Prüfspannung zwischen 2 Kontakten oder Kontakt und Gehäuse</i>	1000 V, 50 Hz, 1 min.
Resistance between mated contacts (MIL-C-24308) <i>Übergangswiderstand pro Kontaktpaar (MIL-C-24308)</i>	≤ 2,7 mΩ
Insulation resistance between contacts <i>Isolationswiderstand Kontakt / Kontakt</i>	≥ 5000 MΩ
Volume resistivity <i>Spezifischer Durchgangswiderstand</i>	10 ¹⁶ Ω cm
Dielectric strength <i>Spezifische Durchschlagfestigkeit</i>	50 kV / mm

Connector Materials and Platings

Materialien und Oberflächen der Steckverbinder

Materials and Platings <i>Materialien und Oberflächen</i>		
Shell <i>Gehäuse</i>	Steel <i>Stahl</i>	
Type / Typ	FM	FH
Insulator <i>Isolierkörper</i>	Polyester, glass filled (UL94V-0), green <i>Polyester, glasfaserverstärkt (UL94V-0), grün</i>	Polyester, glass filled (UL94V-0), natural <i>Polyester, glasfaserverstärkt (UL94V-0), natur</i>
Relative temperature index according to UL 746 B <i>rel. Temperaturindex nach UL 746 B</i>	130 °C (266 °F)	150 °C (302 °F)
Heat deflection temperature limit according to DIN 53461 HDT/A <i>Formbeständigkeitstemperatur nach DIN 53461 HDT/A</i>	210 °C (410 °F)	255 °C (491 °F)
Lower limit temperature <i>Untere Grenztemperatur</i>	-55 °C (-67 °F)	
Shell plating K120 (standard) <i>Gehäuseoberfläche K120 (Standard)</i>	Tin plated over nickel, pin connector shell with dimples <i>verzinkt über Nickel, Stiftsteckverbindergehäuse mit Kontaktnoppen</i>	
Shell plating K121 (standard) <i>Gehäuseoberfläche K 121 (Standard)</i>	Tin plated over nickel, socket connector shell without dimples <i>verzinkt über Nickel, Buchsensteckverbindergehäuse ohne Kontaktnoppen</i>	
Contact material <i>Kontaktmaterial</i>	Cu alloy <i>Cu Legierung</i>	
Contact plating <i>Kontaktflächen</i>	AuroPur or Au over Ni, other platings on request <i>AuroPur oder Au über Ni, andere Oberflächen auf Anfrage</i>	

AuroPur High Performance Gold Plating

AuroPur Hochleistungs-Goldbeschichtung

FCT is introducing a new nickel phosphorous gold plating (min 0,1 μm Au over 2-4 μm chemical NiP) which has better qualities than standard platings.

Connectors and Contacts with nickel phosphorus gold plating have been tested in accordance with DIN 41626, part 1 and DIN 41652 part 2. A relevant test report is available on request:

Sales Team FCT
sales@fctgroup.com

FCT führt eine Nickel-Phosphor-Gold Oberfläche (min 0,1 μm Au über 2 - 4 μm chemisches NiP) ein, die im Vergleich zu herkömmlichen Beschichtungen bessere Eigenschaften aufweist.

Steckverbinder und Kontakte mit Nickel-Phosphor-Gold Oberfläche sind entsprechend den Anforderungen der DIN 41626, Teil 1 und DIN 41652 Teil 2 getestet. Ein entsprechender Testbericht ist auf Anfrage erhältlich von:

Sales Team FCT
sales@fctgroup.com

General Characteristics and Advantages of AuroPur High Performance Gold plating

Allgemeine Eigenschaften und Vorteile der AuroPur Hochleistungs-Goldbeschichtung

- + High abrasion resistance
- + Very good corrosion resistance
- + Low thermal contact resistance, very good contact characteristics
- + Excellent solderability
- + Even plating density
- + **RoHS conform**
- + Non-magnetic on request

- + *hohe Abriebsbeständigkeit*
- + *sehr gute Korrosionsbeständigkeit*
- + *niedriger Kontaktwiderstand, sehr gute Kontakteigenschaften*
- + *hervorragende Lötbarkeit*
- + *gleichmäßige Schichtdicke*
- + **RoHS konform**
- + *auf Wunsch non-magnetisch*

Test Construction and Conditions

Testaufbau und -bedingungen

- + Contact resistance in accordance with DIN 41640 part 4 (Start Value / Value after 250 contact durability tests and 21 days corrosive gas)
- + Mechanical durability in accordance with DIN 41640 part 21 (250 contact durability tests)
- + Industrial atmosphere in accordance with DIN 41640 part 72 (Exposure to flowing mixed gases in accordance with DIN EN 60068-2-60, test Ke, Method 4)
- + Optical testing in accordance with DIN 41640 part 2
- + Solderability in accordance with DIN IEC 68 part 2-20
- + Micro-impedance measuring device EMT 328
- + Corrosion test chamber K350 + TOX gas monitor 7100 (TZO Leipzig)
- + Solder bath in accordance with DIN IEC part 2-20
- + *Durchgangswiderstand nach DIN 41640 Teil 4 (Anfangswert / Wert nach 250 Steckzyklen und 21 Tagen Schadgas)*
- + *Mechanische Lebensdauer nach DIN 41640 Teil 21 (250 Steckzyklen)*
- + *Industriatmosphäre nach DIN 41640 Teil 72 (Belastung durch strömendes Mischgas nach DIN EN 60068-2-60, Prüfung Ke, Methode 4)*
- + *Sichtprüfung nach DIN 41640 Teil 2*
- + *Lötbarkeit nach DIN IEC 68 Teil 2-20*
- + *Mikroimpedanzmeßgerät EMT 328*
- + *Korrosionsprüfkammer K350 + TOX GAS Monitor 7100 (TZO Leipzig)*
- + *Lötbad gemäß DIN IEC Teil 2-20*

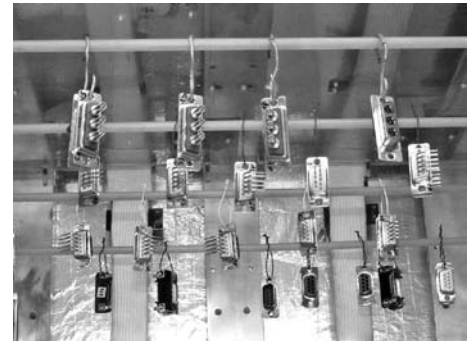

Storage of the test object during the mixed gas exposure
Lagerung der Testobjektes während der Mischgasexposition



Test Report, Derating Diagram

Testbericht, Diagramm Strombelastbarkeit

Test

Messung

Electrical load derating in accordance with DIN 41640 Part 3.

Strombelastbarkeit nach DIN 41640 Teil 3.

Test Object

Messobjekt

Mated Mixed Layout connectors **FM8W8P** and **FM8W8S** fully loaded with eight 40 Amp high power crimp contacts **FMP004P103** and **FMP004S103**.

Zusammengesteckte Mixed Layout Steckverbinder **FM8W8P** und **FM8W8S** vollbestückt mit 8 Stück 40 A Hochstrom Crimpkontakten **FMP004P103** und **FMP004S103**.

Test Procedure

Messanordnung

- In accordance with DIN 41640, Part 3 all contacts were connected in series.
- At various electrical intensities the following measurements were taken: the temperature of the connector at the warmest point and the ambient temperature at a distance of (1.969 ") from the connector (see illustration).
- nach DIN 41640 Teil 3 wurden alle Kontakte in Reihe geschaltet.
- bei verschiedenen Stromstärken wurde jeweils die Temperatur des Steckverbinders an der wärmsten Stelle und die Umgebungstemperatur in 50 mm Abstand gemessen (siehe Abbildung).

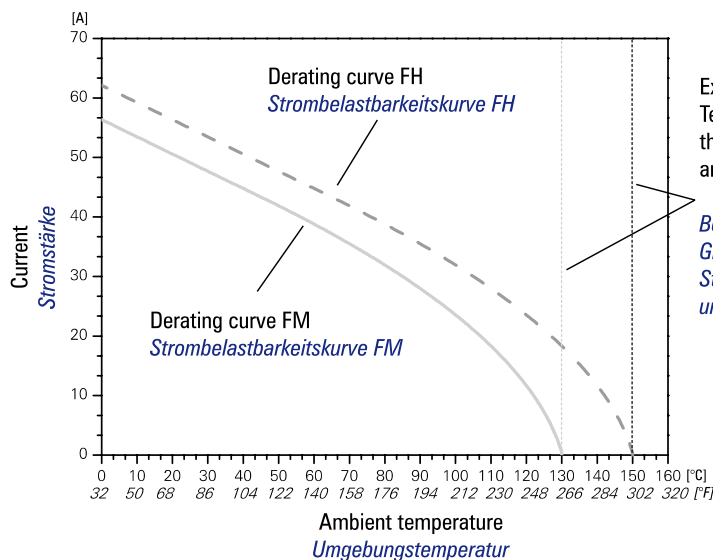
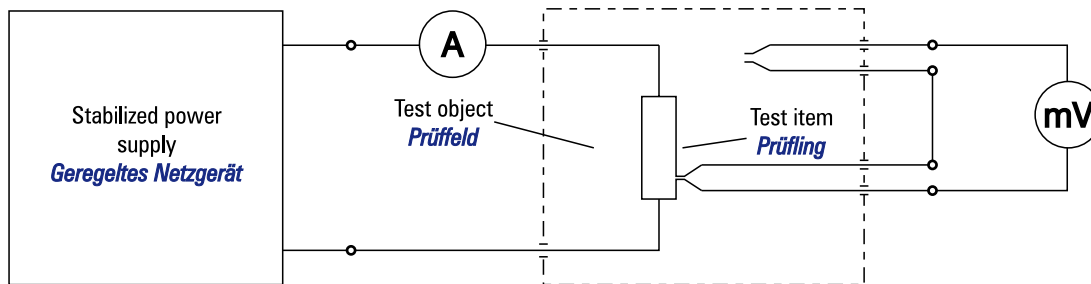

Example: Temperature limit (max.) for the connectors FM8W8P/S and FH8W8P/S.

Beispiel: Grenztemperatur (max.) der Steckverbinder FM8W8P/S und FH8W8P/S.

Test Procedure

Messanordnung

The above electrical load derating curve illustrates the maximum permissible current in relation to ambient temperature i.e.:

- The maximum permissible load at 20 °C (68 °F) is over 40 Amp
- At 100 °C (212 °F) it is still over 25 Amp



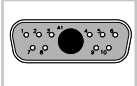

Die obestehende Strombelastbarkeitskurve (Derating-Kurve) zeigt den maximal zulässigen Strom in Abhängigkeit von der Umgebungstemperatur. Zur Erläuterung:

- bei 20 °C liegt die maximale Belastbarkeit über 40 A
- bei 100 °C liegt sie immer noch bei über 25 A



Contact Arrangements (FM-Series with Mounted Signal Contacts)

Polbilder (FM-Baureihe, mit fest eingebauten Signalkontakten)

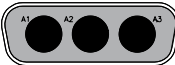
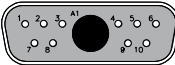
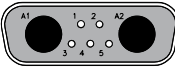
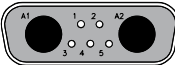
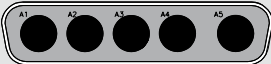
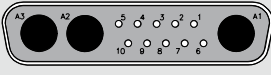
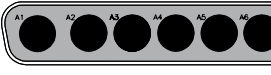
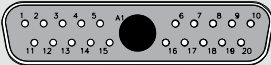
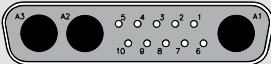
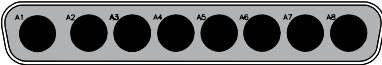
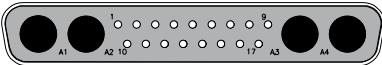
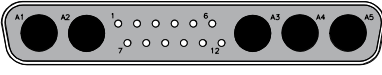
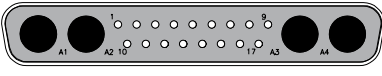
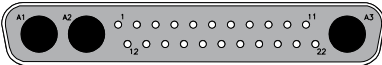
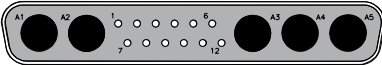
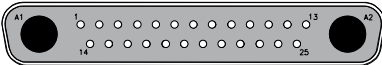
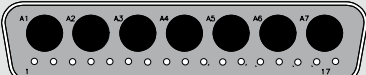
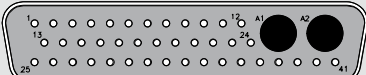
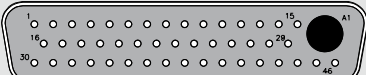
Shell Size <i>Gehäusegröße</i>	Diagram Illustrates Front View of Pin Connectors <i>Abbildung zeigt Frontansicht der Stiftsteckverbinder</i>			
1	 <p>F1W1</p>	 <p>FM5W1</p>	 <p>F2W2 <i>Extended rear part verlängertes Rückteil</i></p>	 <p>F2W2...C</p>
2	 <p>FM3W3</p>	 <p>F3W3...C</p>	 <p>FM7W2</p>	
3	 <p>FM5W5</p>	 <p>FM9W4</p>	 <p>FM13W3</p>	
4	 <p>FM17W2</p>	 <p>FM21W1</p>	 <p>FM8W8</p>	
5	 <p>FM24W7</p>	 <p>FM36W4</p>	 <p>FM17W5</p>	
	 <p>FM21WA4</p>	 <p>FM25W3</p>	 <p>FM27W2</p>	
	 <p>F7W7</p>	 <p>FM24W7</p>	 <p>FM43W2</p>	 <p>FM47W1</p>

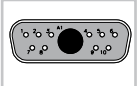

Contact Arrangements (FU/FL Series, for Crimp Signal Contacts)

Polbilder (FU/FL Baureihe, für Crimp-Signalkontakte)

Diagram Illustrates Front View of Pin Connectors <i>Abbildung zeigt Frontansicht der Stiftsteckverbinder</i>		Shell Size <i>Gehäusegröße</i>
<p>Please check availability: <i>Bitte Verfügbarkeit anfragen:</i></p>	<p>5W1</p>	1
<p>FU11W1 FL11W1</p>	<p>FU7W2 FL7W2</p>	2
<p>9W4</p>	<p>FU13W3 FL13W3</p>	3
<p>FU17W2 FL17W2</p>	<p>FU21W1 FL21W1</p>	
<p>FU21WA4 FL21WA4</p>	<p>13W6</p>	4
<p>FU25W3 FL25W3</p>	<p>FU17W5 FL17W5</p>	
<p>27W2</p>	<p>FU21WA5 FL21WA5</p>	
<p>24W7</p>	<p><i>On request / auf Anfrage</i> FU36W4 FL36W4</p>	5
	<p>43W2</p>	
	<p>47W1</p>	

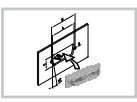

Panel Cut-out

Montageausschnitt

Front Mounted

Frontseitig montiert

Fix Mount, Front Mounted

Feste Montage, Frontseitig montiert

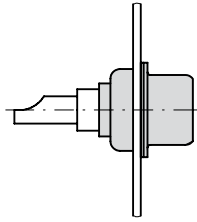
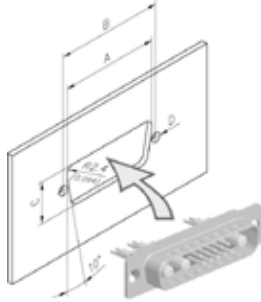

Shell Size Gehäusegröße	A	B	C
1	±0,2 (±0.008)	±0,1 (±0.004)	±0,2 (±0.008)
2	22,2 (0.874)	25,0 (0.984)	12,3 (0.484)
3	30,5 (1.201)	33,3 (1.311)	12,3 (0.484)
4	44,3 (1.744)	47,0 (1.850)	12,3 (0.484)
5	60,7 (2.390)	63,5 (2.500)	12,3 (0.484)
	58,3 (2.295)	61,1 (2.406)	15,1 (0.594)

Float Mount, Front Mounted

Schwimmende Montage, frontseitig montiert

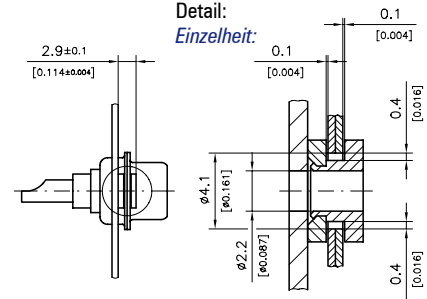

Shell Size Gehäusegröße	Mounting Befestigung	Ø D
1 - 5	Standard / <i>Standard</i>	±0,05 (±0.002)
1 - 5	Float mounted / <i>schwimmend</i>	2,2 (0.087)

Mounting type / Befestigungsart: W

Plain universal float mount rivet on both sides.

Niet ohne Nietbördelung für beidseitige Befestigung.

Ordering example / *Bestellbeispiel*: FMW17W2S

Rear Mounted

Rückseitig montiert

Fix Mount, Rear Mounted

Feste Montage, rückseitig montiert

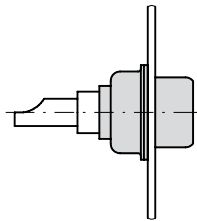
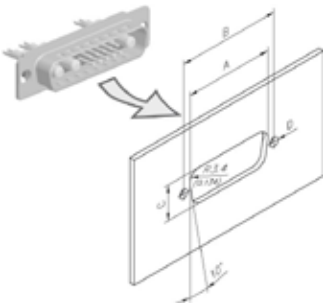

Shell Size Gehäusegröße	A	B	C
1	±0,2 (±0.008)	±0,1 (±0.004)	±0,2 (±0.008)
2	20,5 (0.807)	25,0 (0.984)	11,4 (0.449)
3	28,8 (1.134)	33,3 (1.311)	11,4 (0.449)
4	42,5 (1.673)	47,0 (1.850)	11,4 (0.449)
5	59,1 (2.327)	63,5 (2.500)	11,4 (0.449)
	56,3 (2.217)	61,1 (2.406)	14,1 (0.555)

Float Mount, Rear Mounted

Schwimmende Montage, rückseitig montiert

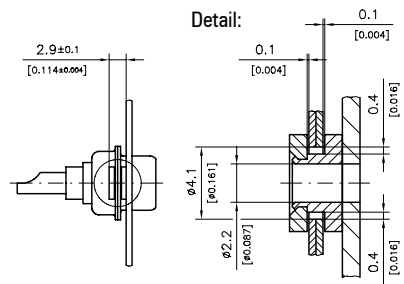

Shell Size Gehäusegröße	Mounting Befestigung	Ø D
1 - 5	Standard / <i>Standard</i>	±0,05 (±0.002)
1 - 5	Float mounted / <i>schwimmend</i>	2,2 (0.087)

Mounting type / Befestigungsart: W

Plain universal float mount rivet on both sides.

Niet ohne Nietbördelung für beidseitige Befestigung.

Ordering example / *Bestellbeispiel*: FMW17W2S

Clinch Nuts

Einnietmuttern

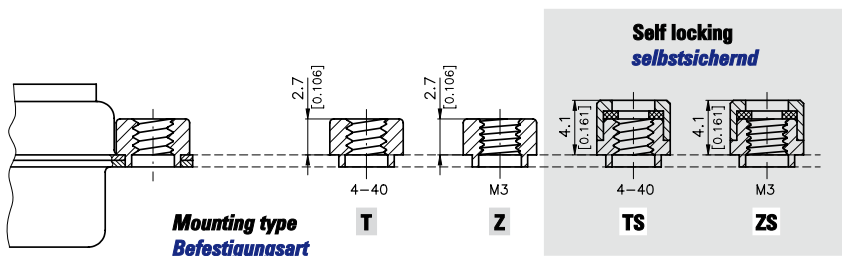

Ordering Example:

Pin connector, contact arrangement 17W2, clinch nut 4-40 UNC, insulator made of polyester, glass filled contacts with solder pot termination:

FMT17W2P

Bestellbeispiel:

Stiftsteckverbinder, Polbild 17W2, Einnietmutter 4-40 UNC, Isolierkörper aus glasfaserverstärktem Polyester, Löttopfkontakte:

FMT17W2P

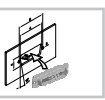

Mounting and Mating Instructions (According to DIN 41652 T1)

Montage- und Steckhinweise (nach DIN 41652 T1)

Pulling Range

Fangbereich

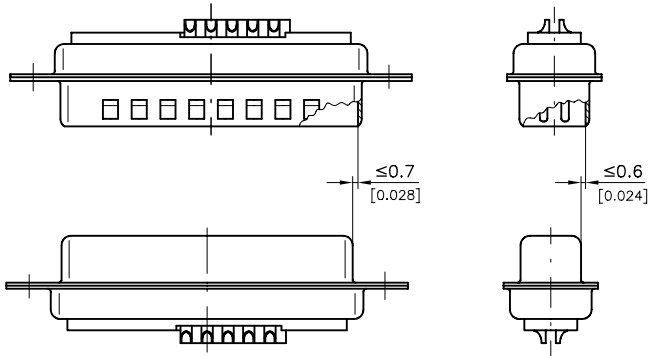

Dimension for Safe Contact Range, Signal Contacts

Maß für sicheren Kontaktbereich, Signalkontakte

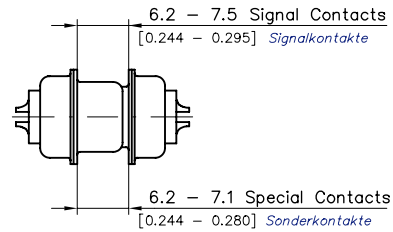

Tolerable Tilt Angle for Connector Mating

Zulässige Schräglage zur Steckrichtung

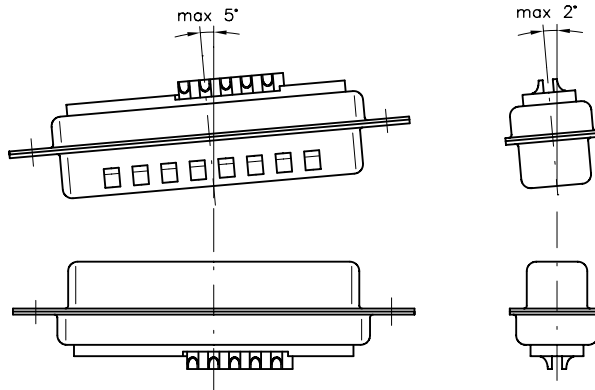

Earthing Methods

Masseanschlussvarianten

Dimples

Kontaktknoppen

Dimples reduce electrical resistance between two shells (only available with **tin plated pin connector shells**).

*Die Kontaktknoppen vermindern den elektrischen Übergangswiderstand zum Gegensteckverbinder (nur für **verzinnte Stiftsteckverbindergehäuse** erhältlich).*

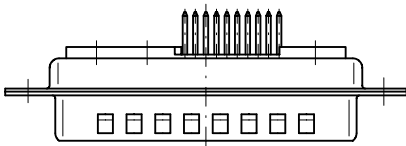

Earthing Springs for Coaxial Contacts

Erdungsfedern für Koaxialkontakte

Special earthing springs (only for FM connectors with Sn shell plating) are available for the earthing of coaxial contact outer conductors.

Für die Masseanbindung (nur für FM-Steckverbinder mit Sn Gehäuseoberflächen) von Koaxialkontaktaussenleitern sind spezielle Erdungsfedern verfügbar.

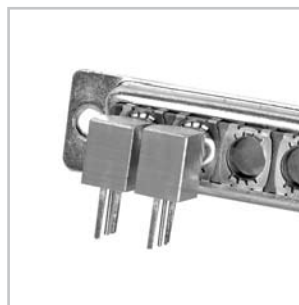

Fig.: Mixed Layout connector with earthing springs and 2 coaxial contacts with right angled PCB terminations.

Abb.: Mixed Layout Stiftsteckverbinder mit Erdungsfedern und 2 abgewinkelten Koaxialkontakten mit Leiterplattenanschluss.

Shell Dimensions, FM Connectors

Gehäuseabmessungen, FM Steckverbinder

Pin Connector Shell

Stiftsteckverbindergehäuse

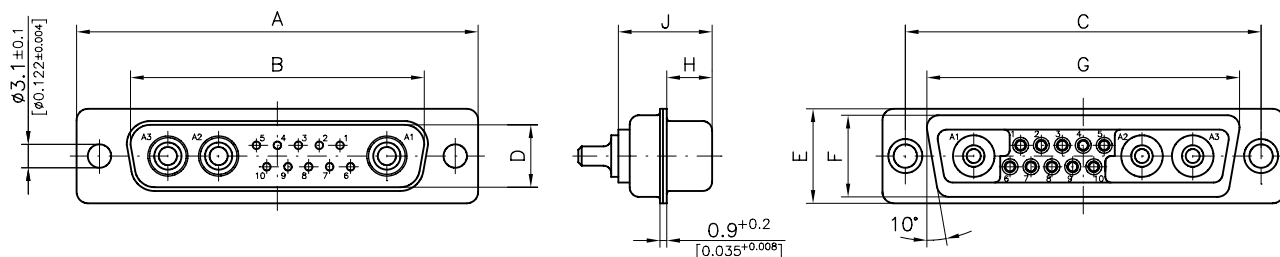

Shell Size Gehäusegröße	A	B	C	D	E	F	G	H	J
	±0,4 (±0.016)	+0,2 (+0.008)	±0,15 (±0.006)	+0,2 (+0.008)	±0,4 (±0.016)	±0,3 (±0.012)	±0,3 (±0.012)	-0,3 (-0.012)	-0,3 (-0.012)
1	30,8 (1.213)	16,9 (0.665)	25,0 (0.984)	8,2 (0.323)	12,5 (0.492)	10,8 (0.425)	19,3 (0.760)	6,1 (0.240)	12,5 (0.492)
2	39,1 (1.539)	25,2 (0.992)	33,3 (1.311)	8,2 (0.323)	12,5 (0.492)	10,8 (0.425)	27,5 (1.083)	6,1 (0.240)	12,5 (0.492)
3	53,0 (2.087)	38,9 (1.531)	47,04 (1.852)	8,2 (0.323)	12,5 (0.492)	10,8 (0.425)	41,3 (1.626)	6,0 (0.236)	12,4 (0.488)
4	69,3 (2.728)	55,3 (2.177)	63,5 (2.500)	8,2 (0.323)	12,5 (0.492)	10,8 (0.425)	57,7 (2.272)	6,0 (0.236)	12,4 (0.488)
5	66,9 (2.634)	52,8 (2.079)	61,1 (2.406)	11,0 (0.433)	15,4 (0.606)	13,7 (0.539)	55,3 (2.177)	6,0 (0.236)	12,4 (0.488)

Socket Connector Shell

Buchsensteckverbindergehäuse

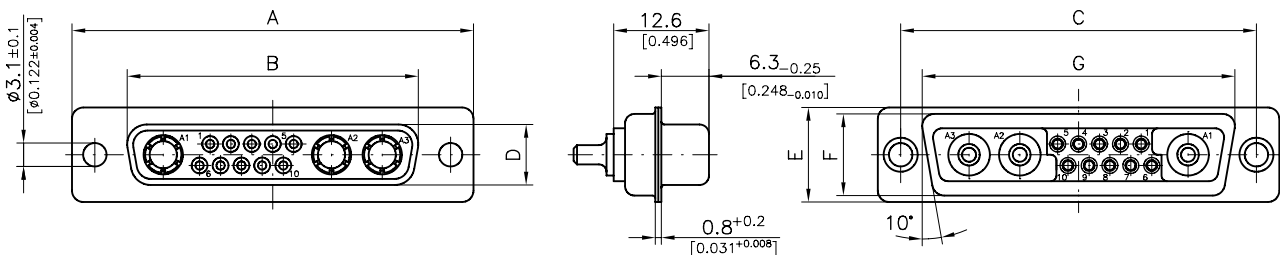

Shell Size Gehäusegröße	A	B	C	D	E	F	G
	±0,4 (±0.016)	-0,2 (-0.008)	±0,15 (±0.006)	-0,2 (-0.008)	±0,4 (±0.016)	±0,3 (±0.012)	±0,3 (±0.012)
1	30,8 (1.213)	16,4 (0.646)	25,0 (0.984)	8,0 (0.315)	12,5 (0.492)	10,8 (0.425)	19,3 (0.760)
2	39,1 (1.539)	24,7 (0.972)	33,3 (1.311)	8,0 (0.315)	12,5 (0.492)	10,8 (0.425)	27,5 (1.083)
3	53,0 (2.087)	38,5 (1.516)	47,04 (1.852)	8,0 (0.315)	12,5 (0.492)	10,8 (0.425)	41,3 (1.626)
4	69,3 (2.728)	54,9 (2.161)	63,5 (2.500)	8,0 (0.315)	12,5 (0.492)	10,8 (0.425)	57,7 (2.272)
5	66,9 (2.634)	52,5 (2.067)	61,1 (2.406)	10,8 (0.425)	15,4 (0.606)	13,7 (0.539)	55,3 (2.177)



Straight Signal Contacts

Gerade Signalkontakte

Solder Pot Termination AWG 20

Löttopfanschluss AWG 20

Straight PCB Termination Ø 0.6 mm (Ø 0.024")

Gerader Leiterplattenanschluss Ø 0,6 mm

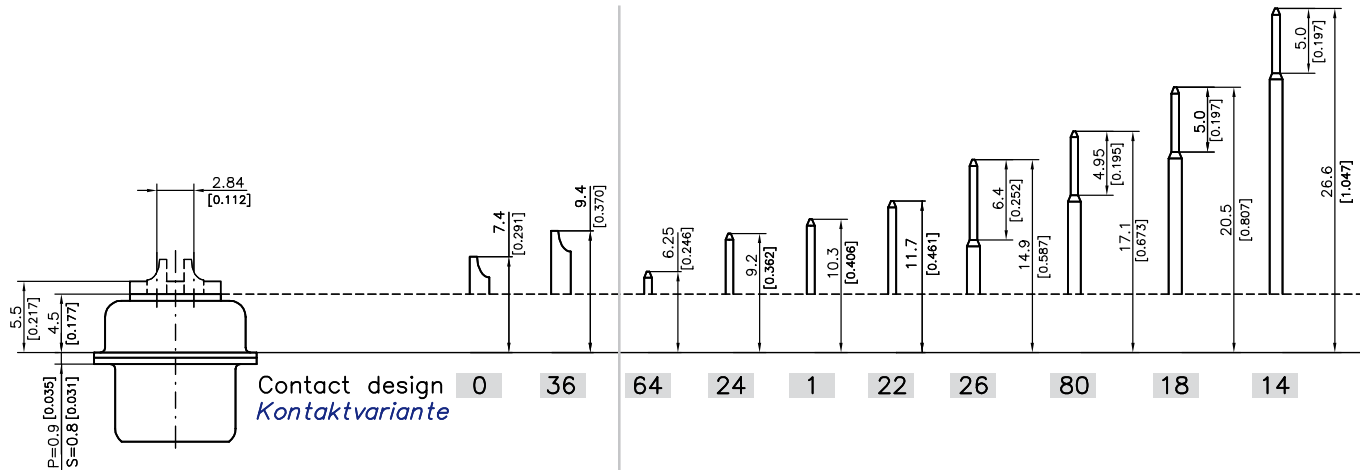

Straight PCB Termination Ø 0.76 mm (Ø 0.030")

Gerader Leiterplattenanschluss Ø 0,76 mm

Wire-Wrap Termination □ 0.6 mm (□ 0.024")

Wire Wrap Anschluss □ 0,6 mm

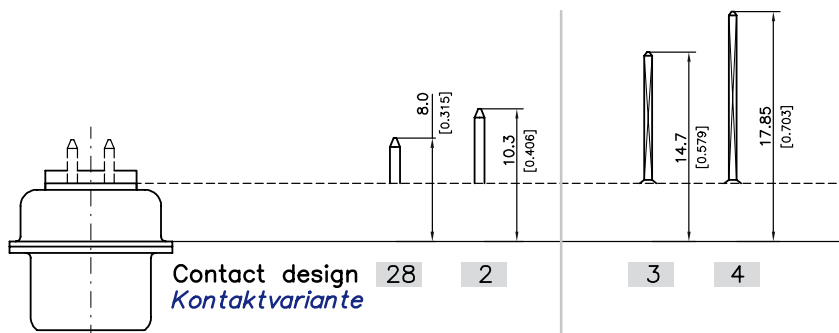



Straight PCB Termination Ø 1.0 mm (Ø 0.039")

Gerader Leiterplattenanschluss Ø 1,0 mm

Non Compliant Pressfit Termination □ 0.8 mm (□ 0.031")

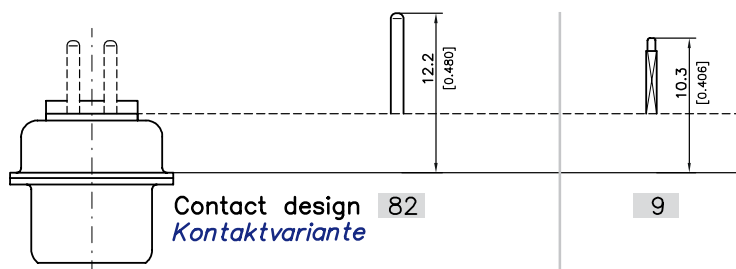
Massiver Einpressanschluss □ 0,8 mm





Signal contacts can not be combined with all types of coaxial, high power, high voltage and pneumatic contacts. For detailed information please contact us. **Die Signalkontakte sind nicht mit allen Koaxial-, Hochstrom-, Hochspannungs- und Pneumatikkontakten kombinierbar. Für genauere Auskünfte nehmen Sie bitte Kontakt mit uns auf.**

Straight PCB Termination Ø 0.6 mm (Ø 0.024"), Short Plug

Gerader Leiterplattenanschluss Ø 0,6 mm, verkürzte Steckseite

Line Contact Termination

Kontaktlamellenanschluss

Only available as pin contacts.
Nur als Stiftkontakt verfügbar.

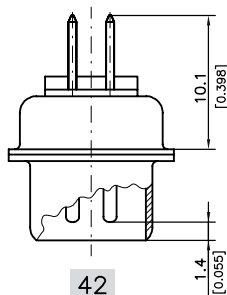

Contact design 42
Kontaktvariante

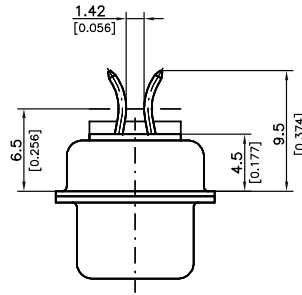

For PCB thickness 1,6 mm (0.063")
Für Leiterplattenstärke 1,6 mm

Contact design 52
Kontaktvariante



Mixed Layout Connector with Accessories

Mixed Layout Steckverbinder mit Anbauteilen

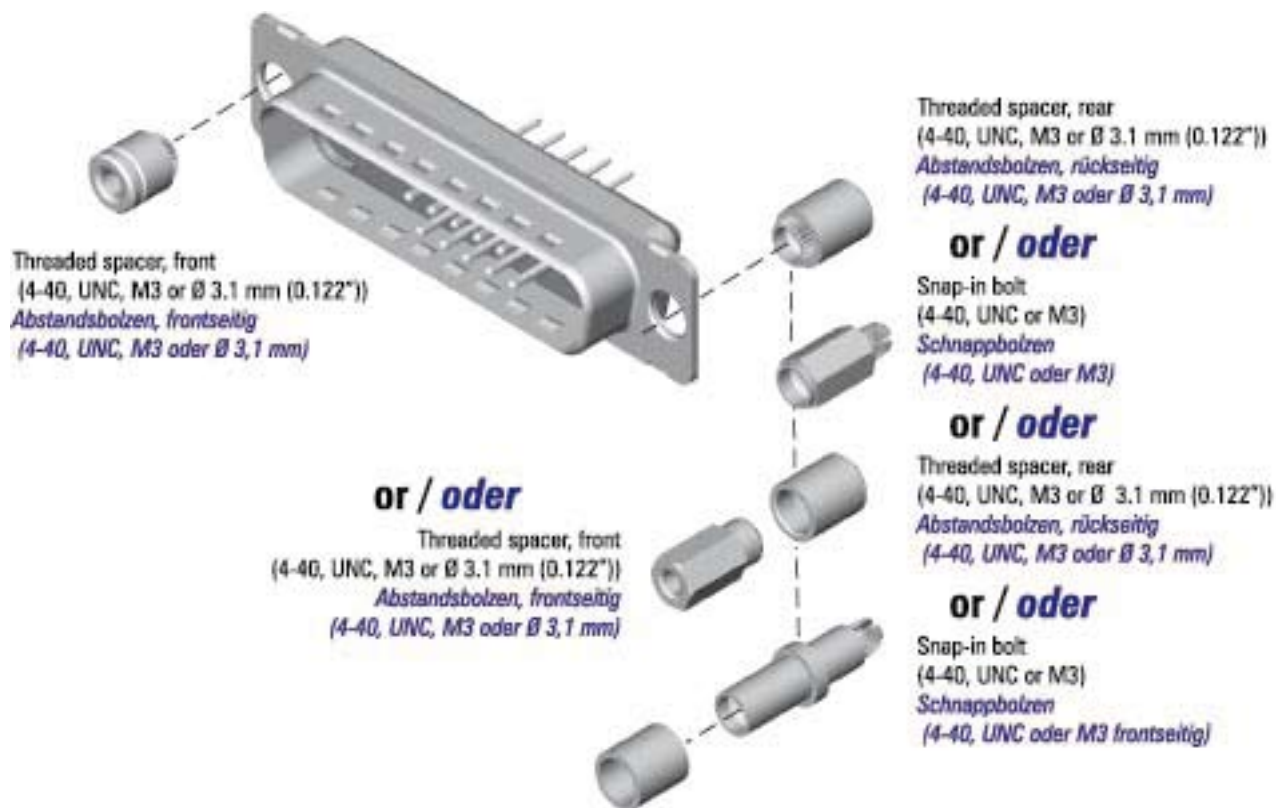

For more detailed information on accessories for Mixed Layout connectors see our D-Sub Miniature Connectors catalogue.
Detaillierte Angaben über Anbauteile für Mixed Layout Steckverbinder entnehmen Sie bitte unserem D-Sub Miniatur Steckverbinder Katalog.



Right Angled Signal Contacts

Abgewinkelte Signalkontakte

Spacing 2.54 mm (0.100"), Ø 0,6 mm (Ø 0.024")

Reihenabstand 2,54 mm, Ø 0,6 mm

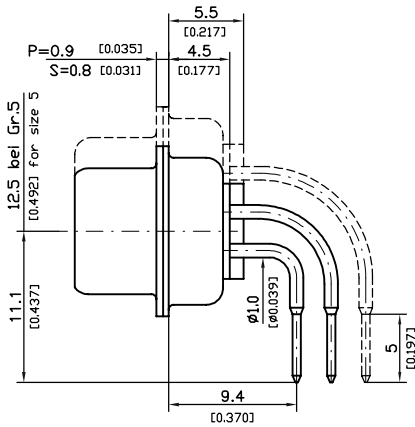

Contact design 5
Kontaktvariante

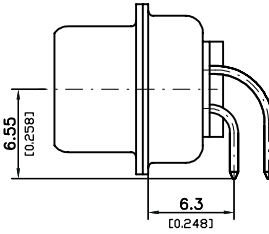

49

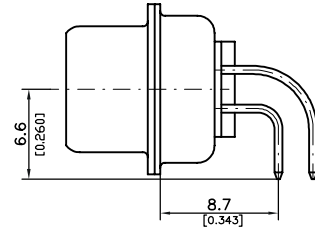

21

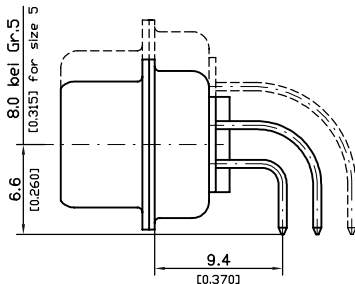

Contact design 45
Kontaktvariante

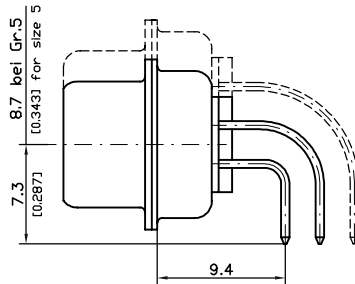

27

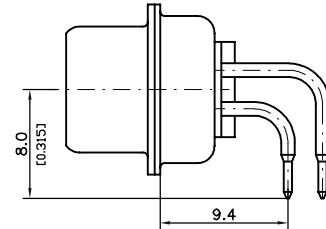

71

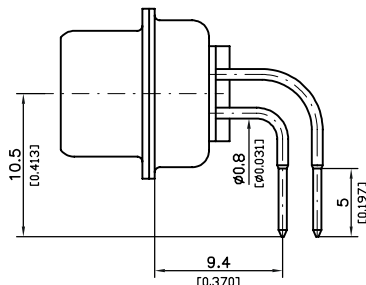

Contact design 25
Kontaktvariante

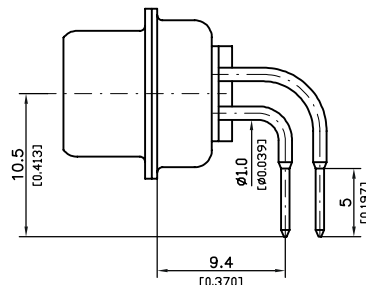

55



Signal contacts can not be combined with all types of coaxial, high power, high voltage and pneumatic contacts. For detailed information please contact us.

Die Signalkontakte sind nicht mit allen Koaxial-, Hochstrom-, Hochspannungs- und Pneumatikkontakten kombinierbar. Für genauere Auskünfte nehmen Sie bitte Kontakt mit uns auf.



Right Angled Signal Contacts

Abgewinkelte Signalkontakte

Spacing 2.54 mm (0.100"), Ø 0.76 mm (Ø 0.030")

Reihenabstand 2,54 mm, Ø 0,76 mm

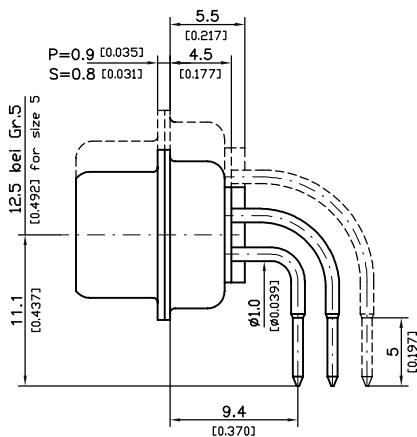

Pin contact on request
Stiftkontakt auf Anfrage

Contact design
Kontaktvariante

6



Signal contacts can not be combined with all types of coaxial, high power, high voltage and pneumatic contacts. For detailed information please contact us.

Die Signalkontakte sind nicht mit allen Koaxial-, Hochstrom-, Hochspannungs- und Pneumatikkontakten kombinierbar. Für genauere Auskünfte nehmen Sie bitte Kontakt mit uns auf.

Spacing 2.84 mm (0.112"), Ø 0.6 mm (Ø 0.024")

Reihenabstand 2,84 mm, Ø 0,6 mm

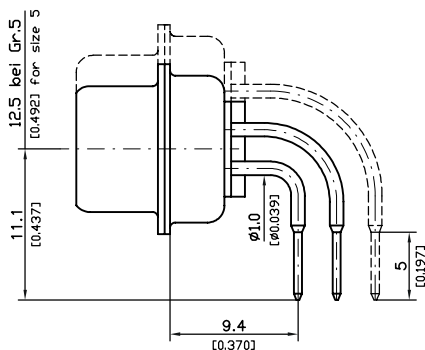

Contact design
Kontaktvariante

41

Spacing 2.84 mm (0.112"), Ø 0.6 mm (Ø 0.024")

Reihenabstand 2,84 mm, Ø 0,6 mm

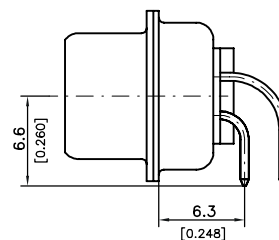

Contact design
Kontaktvariante

65

Spacing 2.54 mm (0.100"), Ø 0.6 mm (Ø 0.024"), Short Plug

Reihenabstand 2,54 mm, Ø 0,6 mm, verkürzte Steckseite

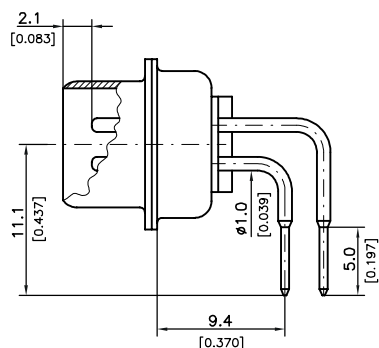

Contact design
Kontaktvariante

69

Spacing 2.84 mm (0.112"), Ø 0.76 mm (Ø 0.030")

Reihenabstand 2,84 mm, Ø 0,76 mm

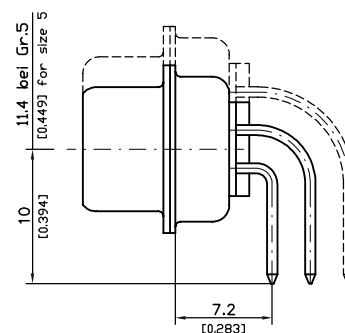

Contact design
Kontaktvariante

12



Mixed Layout Connector with Plastic Brackets FKA1/4 and Accessories

Mixed Layout Steckverbinder mit Kunststoffwinkel FKA1/4 und Anbauteilen

Snap-in grounding bracket
for PCB thickness 1.6 mm (0.063")
*Snap-in Massewinkel für
Leiterplattenstärke 1,6 mm*

or / oder

Grounding bracket
Massewinkel

Plastic bracket
FKA 1/4
*Kunststoffwinkel
FKA1/4*

Double rivet,
outer Ø 2.8 mm (Ø 0.110")
*Doppelrohrniet,
Außen- Ø 2,8 mm*

or / oder

Snap-in rivet for
PCB thickness 1.6 mm (0.063")
*Snap-in Niet für Leiter-
plattenstärke 1,6 mm*

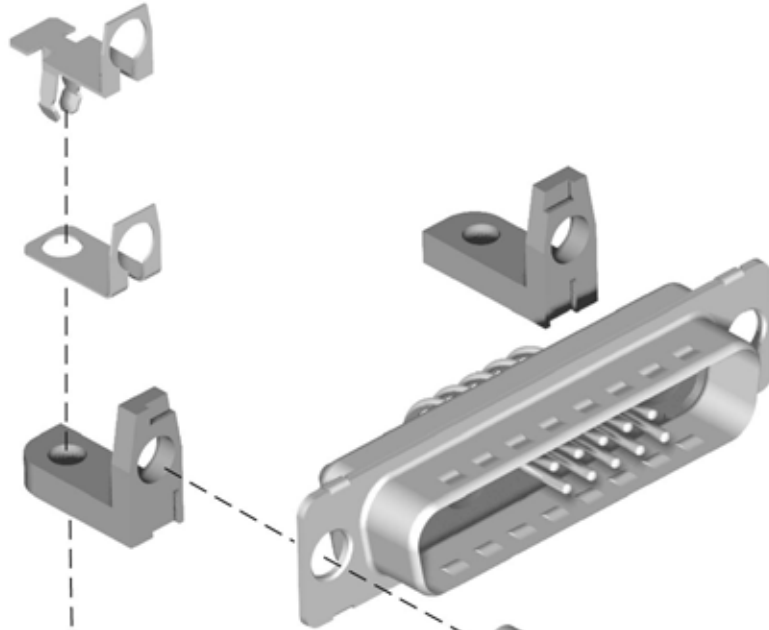

Through hole, Ø 3,1 mm (Ø 0.122")
Nietbuchse, Loch- Ø 3,1 mm

or / oder

Clinch nut
(4-40 UNC or M3)
*Einnietmutter
(4-40 UNC oder M3)*

or / oder

Threaded spacer
(4-40 UNC or M3),
height 6,3 mm (0.248")
*Abstandsbolzen
(4-40 UNC oder M3),
Höhe 6,3 mm*

or / oder

Slide lock rivet
*Gleitverriegelungs-
niet*



For more detailed information on accessories for Mixed Layout connectors see our **D-Sub Miniature Connectors catalogue**.
*Detaillierte Angaben über Anbauteile für Mixed Layout Steckverbinder entnehmen Sie bitte unserem **D-Sub Miniatur Steckverbinder Katalog**.*



Mixed Layout Connector with Metal Brackets F1080-... and Accessories

Mixed Layout Steckverbinder mit Metallwinkel F1080-... und Anbauteilen

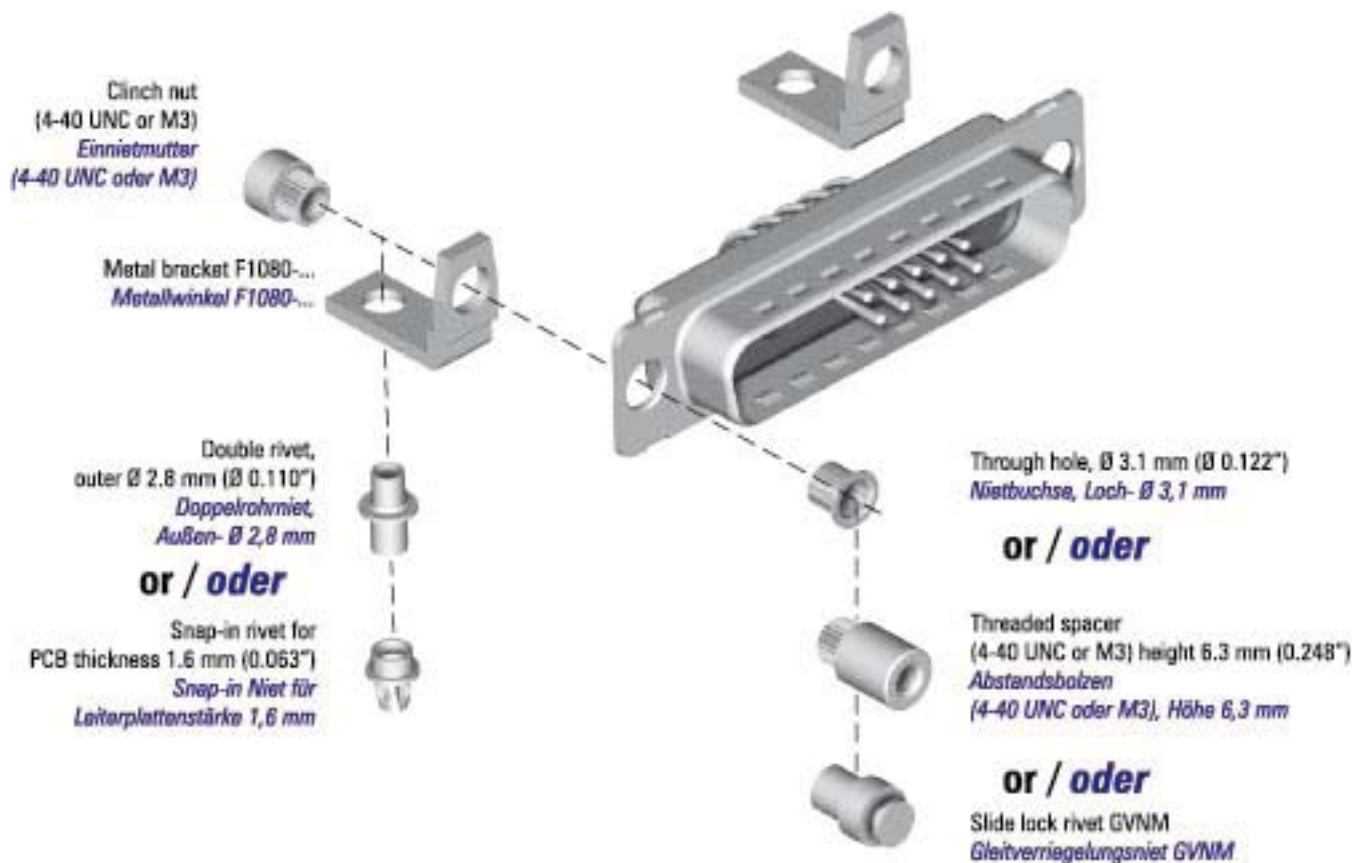

For more detailed information on accessories for Mixed Layout connectors see our **D-Sub Miniature Connectors catalogue**.
*Detaillierte Angaben über Anbauteile für Mixed Layout Steckverbinder entnehmen Sie bitte unserem **D-Sub Miniatur Steckverbinder Katalog**.*



Crimp Connectors

Crimp Steckverbinder

Technical Data FL-, FU-series

Technische Daten FL-, FU-Serie

FL- and **FU-** connectors have an economical plastic-clip system for crimp signal contacts. These can be exchanged after assembly. In addition the **FU-series** is equipped with high quality thermoplastic insulators. **FL-connectors** are supplied without contacts. **FU-connectors** are supplied with turned contacts as standard.

Ordering example for an FL-connector with tin plated shell and dimples:

FL13W3P7-K120

FL- bzw. FU-Steckverbinder besitzen ein wirtschaftliches Plastik-Clipsystem für Crimpsignalkontakte. Diese sind nach Bestückung wieder austauschbar. Die FU-Baureihe ist darüberhinaus mit einem Isolierkörper ausgerüstet, der erhöhte Temperatur- und Festigkeitswerte besitzt. FL-Steckverbinder werden serienmäßig ohne Kontakte geliefert. Bei FU-Steckverbindern sind diese in gedrehter Ausführung im Lieferumfang enthalten.

Bestellbeispiel für FL-Steckverbinder mit verzinnem Gehäuse und Kontaktnoppen:

FL13W3P7-K120

Signal Contact Mechanical Data

Mechanische Daten des Signalkontakts

Mechanical Data <i>Mechanische Daten</i>	
Mating force per signal contact <i>Steckkraft pro Signalkontakt</i>	≤ 3,4 N
Unmating force per signal contact <i>Ziehkraft pro Signalkontakt</i>	≥ 0,2 N
Mating cycles <i>Steckzyklen</i>	≥ 500
Maximum outer diameter of cable to be used <i>Maximal verwendbarer Kabelaußendurchmesser</i>	2,2 mm (0.087")

Connector Electrical Data

Elektrische Daten des Steckverbinders

Electrical Data <i>Elektrische Daten</i>	
Current rating (DC with an ambient temperature of 20°C) <i>Maximale Stromstärke (DC bei 20°C Umgebungstemperatur)</i>	5 A
Test voltage between 2 contacts or shell and contact <i>Prüfspannung zwischen 2 Kontakten oder Kontakt und Gehäuse</i>	1000 V, 50 Hz, 1 min.
Resistance between mated contacts <i>Übergangswiderstand pro Kontaktpaar</i>	≤ 10 mΩ
Insulation resistance between contacts <i>Isolationswiderstand Kontakt / Kontakt</i>	≥ 5000 MΩ
Volume resistivity (ASTM-D 257) <i>Spezifischer Durchgangswiderstand (ASTM-D 257)</i>	10 ¹⁶ Ω cm
Dielectric strength <i>Spezifische Durchschlagsfestigkeit</i>	50 kV / mm

Connector Materials and Platings

Materialien und Oberflächen des Steckverbinders

Materials and Platings <i>Materialien und Oberflächen</i>		
Shell <i>Gehäuse</i>	Steel <i>Stahl</i>	
Type / Typ	FL	FU
Insulator <i>Isolierkörper</i>	black thermoplastic, glass filled (UL94V-0) <i>Baureihe FL: schwarz; glasfaserverstärkt (UL94V-0)</i>	green, thermoplastic, glass filled (UL94V-0) <i>Baureihe FU: grün, Thermoplast, glasfaserverstärkt (UL94V-0)</i>
Relative temperature index according to UL 746 B <i>rel. Temperaturindex nach UL 746 B</i>	115 °C (239 °F)	130 °C (266 °F)
Heat deflection temperature limit according to DIN 53461 HDT/A <i>Formbeständigkeitstemperatur nach DIN 53461 HDT/A</i>	185 °C (365 °F)	197 °C (386,6 °F)
Sub temperature limit <i>Untere Grenztemperatur</i>	-55 °C (-67 °F)	
Shell plating (standard) <i>Gehäuseoberfläche (Standard)</i>	Yellow chromate over zinc plating <i>verzinkt und gelb chromatiert</i>	



Crimp Connectors

Crimp Steckverbinder

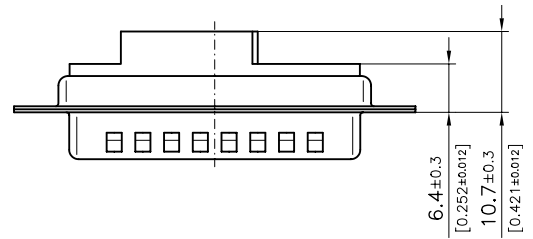

Pin Connector Shell

Stiftsteckverbindergehäuse

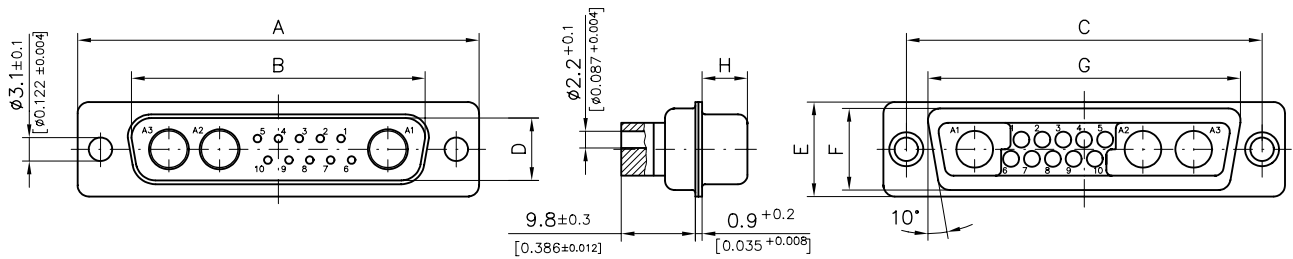

Shell Size Gehäusegröße	A	B	C	D	E	F	G	H
	±0,4 (±0.016)	+0,2 (+0.008)	±0,15 (±0.006)	+0,2 (+0.008)	±0,4 (±0.016)	±0,3 (±0.012)	±0,3 (±0.012)	-0,3 (-0.012)
1	30,8 (1.213)	16,9 (0.665)	25,0 (0.984)	8,2 (0.323)	12,5 (0.492)	10,8 (0.425)	19,3 (0.760)	6,1 (0.240)
2	39,1 (1.539)	25,2 (0.992)	33,3 (1.311)	8,2 (0.323)	12,5 (0.492)	10,8 (0.425)	27,5 (1.083)	6,1 (0.240)
3	53,0 (2.087)	38,9 (1.531)	47,04 (1.852)	8,2 (0.323)	12,5 (0.492)	10,8 (0.425)	41,3 (1.626)	6,0 (0.236)
4	69,3 (2.728)	55,3 (2.177)	63,5 (2.500)	8,2 (0.323)	12,5 (0.492)	10,8 (0.425)	57,7 (2.272)	6,0 (0.236)
5	66,9 (2.634)	52,8 (2.079)	61,1 (2.406)	11,0 (0.433)	15,4 (0.606)	13,7 (0.539)	55,3 (2.177)	6,0 (0.236)

Socket Connector Shell

Buchsensteckverbindergehäuse

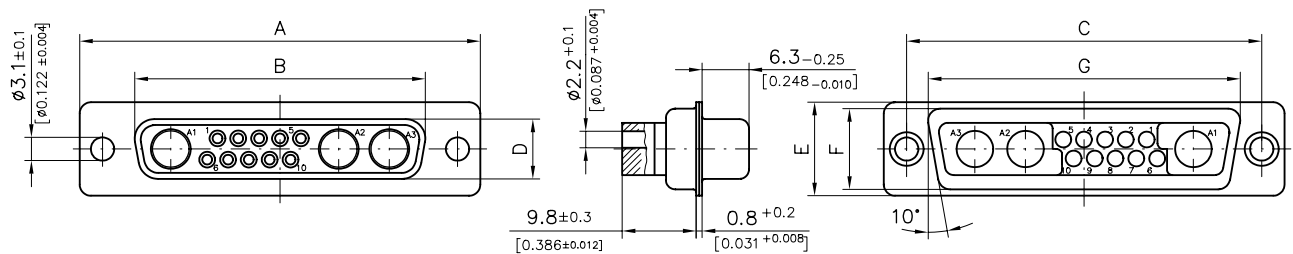

Shell Size Gehäusegröße	A	B	C	D	E	F	G
	±0,4 (±0.016)	-0,2 (-0.008)	±0,15 (±0.006)	-0,2 (-0.008)	±0,4 (±0.016)	±0,3 (±0.012)	±0,3 (±0.012)
1	30,8 (1.213)	16,4 (0.646)	25,0 (0.984)	8,0 (0.315)	12,5 (0.492)	10,8 (0.425)	19,3 (0.760)
2	39,1 (1.539)	24,7 (0.972)	33,3 (1.311)	8,0 (0.315)	12,5 (0.492)	10,8 (0.425)	27,5 (1.083)
3	53,0 (2.087)	38,5 (1.516)	47,04 (1.852)	8,0 (0.315)	12,5 (0.492)	10,8 (0.425)	41,3 (1.626)
4	69,3 (2.728)	54,9 (2.161)	63,5 (2.500)	8,0 (0.315)	12,5 (0.492)	10,8 (0.425)	57,7 (2.272)
5	66,9 (2.634)	52,5 (2.067)	61,1 (2.406)	10,8 (0.425)	15,4 (0.606)	13,7 (0.539)	55,3 (2.177)



Turned Contacts for Crimp Connectors

Gedrehte Kontakte für Crimp Steckverbinder

Pin

Stift

Socket

Buchse



Wire Size (AWG) <i>Drahtgröße (AWG)</i>	Order Number <i>Bestellnummer</i>	MIL-No. <i>MIL-Nummer</i>	Au (Over Ni) <i>Au über Ni</i>	Type <i>Typ</i>
18-22	FK20S18-02V...		0,2 µm (8 microinches)	Socket / <i>Buchse</i>
18-22	FK20PL18-02V...		0,2 µm (8 microinches)	Pin / <i>Stift</i>
18-22	FK20SL18-02V...		0,2 µm (8 microinches)	Socket / <i>Buchse</i>
20-24	FK20P-13V...	M24308/11-1, M39029/64-369	1,3 µm (51 microinches)	Pin / <i>Stift</i>
20-24	FK20S-13V...	M24308/10-1, M39029/63-368	1,3 µm (51 microinches)	Socket / <i>Buchse</i>
20-24	FK20PL-02V...		0,2 µm (8 microinches)	Pin / <i>Stift</i>
20-24	FK20SL-02V...		0,2 µm (8 microinches)	Socket / <i>Buchse</i>
20-24	FK20PL-08V...		0,8 µm (31 microinches)	Pin / <i>Stift</i>
20-24	FK20SL-08V...		0,8 µm (31 microinches)	Socket / <i>Buchse</i>
26-28	FK20P26-13V...		1,3 µm (51 microinches)	Pin / <i>Stift</i>
26-28	FK20S26-13V...		1,3 µm (51 microinches)	Socket / <i>Buchse</i>
26-28	FK20PL26-02V...		0,2 µm (8 microinches)	Pin / <i>Stift</i>
26-28	FK20SL26-02V...		0,2 µm (8 microinches)	Socket / <i>Buchse</i>

Packing Unit

Verpackungseinheit

Ordering Example

Bestellbeispiel

Packing Unit (Pieces) <i>Verpackungseinheit (Stück)</i>	Addition to Order Number <i>Bestellnummernergänzung</i>
100	<u>0100</u>
1000	<u>1000</u>
5000	<u>5000</u>

FK20SL-08V_0100

FK20SL-08V: Crimp socket contact for wire size 20 - 24, plating: 0.8 µm (51 microinches) Au over Ni.

0100: 100 pieces are packed in one bag.

FK20SL-08V: *Crimpbuchsenkontakt für Drahtgröße AWG 20 - 24, Oberfläche 0,8 µm Au über Ni.*

0100: *100 Stück in einem Beutel verpackt.*

Crimping Tools

Crimpwerkzeuge

Contact Type <i>Kontakttyp</i>	Tool <i>Werkzeug</i>
For use with contact types: FK20S18, FK20P, FK20S, FK20P26, FK20S26 <i>Für Kontakttypen:</i> <i>FK20S18, FK20P, FK20S, FK20P26, FK20S26</i>	Hand crimp tool M22520/2-01 and positioner M22520/2-08 <i>Handcrimpzange M22520/2-01 und Einsatz M22520/2-08</i>
For use with contact types: FK20PL18, FK20SL18, FK20PL, FK20SL, FK20PL26, FK20SL26 <i>Für Kontakttypen:</i> <i>FK20PL18, FK20SL18, FK20PL, FK20SL, FK20PL26, FK20SL26</i>	Hand crimp tool M22520/2-01 and positioner K761 or hand crimp tool including positioner 2761 <i>Handcrimpzange M22520/2-01 und Einsatz K761 oder Handcrimpzange inklusive Einsatz 2761</i>

See page 94
Siehe Seite 94

General Information on Special Contacts for Mixed Layout Connectors

Allgemeine Informationen über Sonderkontakte für Mixed Layout Steckverbinder

The mixed layout series is designed so that any FCT special contacts (75 and 50 Ω coaxial contacts, high power contacts up to 40 A, high voltage contacts up to 3 kV and pneumatic contacts) may be installed in any of the contact arrangements we supply. Depending on your application, there is a choice between solder pot, straight PCB, right angle PCB or crimp terminations. Naturally we also supply insertion and removal tools for the crimp versions (see page 86) to ensure safe and reliable installation.

Die Mixed Layout - Steckverbinderbaureihe ist so konzipiert, dass jeder der FCT-Sonderkontakte (Koaxialkontakte mit 75 oder 50 Ω, Hochstromkontakte bis 40 A, Hochspannungskontakte bis 3 kV und Pneumatikkontakte) in jedes von uns angebotene Polbild eingesetzt werden kann. Je nach Anwendungsfall können Sie unter verschiedenen Anschlussarten auswählen, wie Löttopf-, gerader und abgewinkelter Leiterplattenanschluss sowie Crimpanschluss. Für Crimpversionen sind selbstverständlich die passenden Werkzeuge (siehe Seite 86) erhältlich, die eine sichere und zuverlässige Verarbeitung gewährleisten.



Fig. 1: Mixed Layout socket connector, contact arrangement 21WA4, 2 high power and coaxial contacts with right angled PCB termination and several accessories

Abb. 1: Mixed Layout Buchsensteckverbinder, Polbild 21WA4, 2 Hochstrom- und Koaxialkontakte mit abgewinkelter Leiterplattenanschluss und verschiedenen Anbauteilen



Fig. 2: Mixed Layout pin connector loaded with high power, coaxial, pneumatic and high voltage contacts

Abb. 2: Mixed Layout Stiftsteckverbinder mit montiertem Hochstrom-, Koaxial-, Pneumatik- und Hochspannungskontakt



Fig. 3: Mixed Layout socket connector, contact arrangement 3W3, 3 high power contacts with right angled PCB termination in press-fit version

Abb. 3: Mixed Layout Buchsensteckverbinder, Polbild 3W3, 3 Hochstromkontakte mit abgewinkelter Leiterplattenanschluss in Press-fit Ausführung



Fig. 4: Contact with quadruple slit support socket, modification B

Abb. 4: Kontakt mit vierfach geschlitzter Kontaktbuchse, Modifikation B



Fig. 5: Contact with sextuple slit support socket, FCT standard contact

Abb. 5: Kontakt mit sechsfach geschlitzter Kontaktbuchse, FCT-Standardkontakt

Contacts with quadruple slit support socket (see fig. 4) are particularly suitable for robust use and for use with mating contacts which have a low conical form, e. g. insertion shafts.

FCT standard contacts with sextuple slit support socket (see fig. 5) excel as a result of six contact support points and soft mating.

Kontakte mit vierfach geschlitzter Kontaktbuchse (siehe Abbildung 4) sind besonders geeignet für robuste Anwendungen und bei Gegenkontakten mit geringer Konizität, z. B. für Einschubschächte.

FCT-Standardkontakte mit sechsfach geschlitzter Kontaktbuchse (siehe Abbildung 5) zeichnen sich durch sechs Kontaktauflegpunkte und weiche Gegensteckung aus.



Plugs or pin contacts may only be mounted in male connectors, receptacles or sockets may only be mounted in female connectors.

Stecker bzw. Stiftkontakte (P) dürfen nur in Stiftsteckverbinder (Messerleisten), Steckdosen bzw. Buchsenkontakte (S) nur in Buchsensteckverbinder (Federleisten) montiert werden.



Code for Special Contacts

Nummernschlüssel für Sonderkontakte

Ordering Code

Bestellschlüssel

	FMX	006	P	102	K
Series / Baureihe					
FMX Coaxial contacts for cable termination / <i>Koaxialkontakt für Kabelanschluss</i>					
FMS Coaxial contacts for cable termination / <i>Koaxialkontakt für Kabelanschluss</i>					
FME Coaxial contacts for PCB termination / <i>Koaxialkontakt für Leiterplattenanschluss</i>					
FBM Coaxial contacts (blind mate) / <i>Koaxialkontakt (Blind mate)</i>					
FMP High power contacts / <i>Hochstromkontakt</i>					
FMV High voltage contacts / <i>Hochspannungskontakt</i>					
FMG Pneumatic contacts / <i>Pneumatikkontakt</i>					
Contact version (consecutively numbered) / Kontaktausführung (fortlaufende Nummer)					
Contact type / Kontaktart					
P Pin contact or plug, for coaxial contacts: outer conductor - pin, inner conductor - socket <i>Stiftkontakt bzw. Stecker, bei Koaxialkontakt gilt: Außenleiter - Stift, Innenleiter - Buchse</i>					
S Socket contact or receptacle, for coaxial contacts: outer conductor - socket, inner conductor - pin <i>Buchsenkontakt bzw. Steckdose, bei Koaxialkontakt gilt: Außenleiter - Buchse, Innenleiter - Stift</i>					
Plating specifications / Oberflächenspezifikation					
Modifications / Modifikationen					

Series

Baureihen

FMX-Series

FMX-Serie

- Coaxial contact for cable termination
- Inner conductor for solder termination
- Outer conductor for solder termination
- Outer conductor for solder or crimp termination
- *Koaxialkontakt für Kabelanschluss*
- *Innenleiter zum Löten*
- *Außenleiter zum Löten*
- *Außenleiter zum Löten oder Crimpen*

FMP-Series

FMP-Serie

- High power contacts
- *Hochstromkontakte*

Modifications

Modifikationen

Modifications / Modifikationen		
B	Socket with 4 slits	<i>Buchse mit vier Schlitzen</i>
E	With earthing spring	<i>mit Erdungsfeder</i>
F	Greased contacts	<i>befettete Kontakte</i>
K	With plastic retention clip	<i>mit Kunststoffhalterung</i>
M	CuBe retention clip	<i>CuBe-Halterung</i>
R	With knurl for secure fixing in the insulator	<i>mit Rändel für festen Sitz im Isolierkörper</i>
U	Narrower insertion zone for a more secure fixing in the insulator with a Cu-Be-retention clip	<i>engeres Einrastmaß für festen Sitz im Isolierkörper mit Cu-Be-Halterung</i>
W	With spring washer	<i>mit Federring</i>

FMS-Series

FMS-Serie

- Coaxial contact for cable termination
- Inner conductor for crimp or solder termination
- Crimp Snap-In System
- Outer conductor for solder or crimp termination
- *Koaxialkontakt für Kabelanschluss*
- *Innenleiter zum Crimpen oder Löten*
- *Crimp Snap-In System*
- *Außenleiter zum Löten oder Crimpen*

FMV-Series

FMV-Serie

- High voltage contacts
- *Hochspannungskontakte*

FME-Series

FME-Serie

- Coaxial contact for PCB termination
- *Koaxialkontakt für Leiterplattenanschluss*

FBM-Series

FBM-Serie

- Coaxial contact for D-Sub / Blind mate / For hidden mounting, e.g. in drawers for frequencies up to 3.5 GHz.
- *Koaxialkontakte für D-Sub / Blind mate / Für verdecktes Stecken z. B. bei Einschubschächten für Frequenzen bis zu 3,5 GHz*

FMG-Series

FMG-Serie

- Pneumatic contacts
- *Pneumatikkontakte*



Plating Specifications for the Series FMX, FMS, FME and FBM

Oberflächenspezifikationen für die Baureihen FMX, FMS, FME und FBM

	Mating Area / <i>Steckbereich</i>		Termination Area / <i>Anschlussbereich</i>		RoHS	Comment / <i>Bemerkung</i>
	Outer Conductor / <i>Außenleiter</i>	Inner Conductor / <i>Innenleiter</i>	Inner Conductor / <i>Innenleiter</i>	Outer Conductor / <i>Außenleiter</i>		
101	0,2 µm (8 microinches) Au over Ni / <i>Au über Ni</i>	0,2 µm (8 microinches) Au over Ni / <i>Au über Ni</i>	0,2 µm (8 microinches) Au over Ni / <i>Au über Ni</i>	5 µm (200 microinches) Sn over Ni / <i>Sn über Ni</i>	•	Low cost
102	0,8 µm (30 microinches) Au over Ni / <i>Au über Ni</i>	1,3 µm (50 microinches) Au over Ni / <i>Au über Ni</i>	1,3 µm (50 microinches) Au over Ni / <i>Au über Ni</i>	0,2 µm (8 microinches) Au over Ni / <i>Au über Ni</i>	•	Standard
108	0,8 µm (30 microinches) Au over Ni / <i>Au über Ni</i>	1,3 µm (50 microinches) Au over Ni / <i>Au über Ni</i>	1,3 µm (50 microinches) Au over Ni / <i>Au über Ni</i>	5 µm (200 microinches) Sn over Ni / <i>Sn über Ni</i>	•	
111	0,8 µm (30 microinches) Au over Cu / <i>Au über Cu</i>	1,3 µm (50 microinches) Au over Cu / <i>Au über Cu</i>	1,3 µm (50 microinches) Au over Cu / <i>Au über Cu</i>	0,2 µm (8 microinches) Au over Cu / <i>Au über Cu</i>	•	Non-magnetic
128	5 µm (200 microinches) Au over Cu / <i>Au über Cu</i>	5 µm (200 microinches) Au over Cu / <i>Au über Cu</i>	5 µm (200 microinches) Au over Cu / <i>Au über Cu</i>	5 µm (200 microinches) Sn over Ag over Cu / <i>Sn über Ag über Cu</i>	•	Non-magnetic
154	0,8 µm (30 microinches) Au over Ni / <i>Au über Ni</i>	1,3 µm (50 microinches) Au over Ni / <i>Au über Ni</i>	1,3 µm (50 microinches) Au over Ni / <i>Au über Ni</i>	0,2 µm (8 microinches) Au over Ni / <i>Au über Ni</i>	•	CuBe design <i>CuBe-Ausführung</i>
201	0,1 µm (4 microinches) Au over NiP / <i>Au über NiP</i>	0,1 µm (4 microinches) Au over NiP / <i>Au über NiP</i>	0,1 µm (4 microinches) Au over NiP / <i>Au über NiP</i>	5 µm (200 microinches) Sn over Ni / <i>Sn über Ni</i>	•	AuroPur / Tin
202	0,1 µm (4 microinches) Au over NiP / <i>Au über NiP</i>	0,1 µm (4 microinches) Au over NiP / <i>Au über NiP</i>	0,1 µm (4 microinches) Au over NiP / <i>Au über NiP</i>	0,2 µm (8 microinches) Au over Ni / <i>Au über Ni</i>	•	AuroPur

Further platings on request / *Weitere Oberflächen auf Anfrage*

Plating Specifications (High Power Contacts)

Oberflächenspezifikationen (Hochstromkontakte)

	Mating Area / <i>Steckbereich</i>		Termination Area / <i>Anschlussbereich</i>		RoHS	Comment / <i>Bemerkung</i>
	Material <i>Material</i>	Plating <i>Oberfläche</i>	Material <i>Material</i>	Plating <i>Oberfläche</i>		
103	Cu-alloy <i>Kupferlegierung</i>	0,8 µm (30 microinches) Au over Ni / <i>Au über Ni</i>	Cu-alloy <i>Kupferlegierung</i>	0,2 µm (8 microinches) Au over Ni / <i>Au über Ni</i>	•	Standard
104	Cu-alloy <i>Kupferlegierung</i>	0,8 µm (30 microinches) Au over Ni / <i>Au über Ni</i>	Cu-alloy <i>Kupferlegierung</i>	5 µm (200 microinches) Sn over Ni / <i>Sn über Ni</i>	•	Standard
105	Cu-alloy <i>Kupferlegierung</i>	0,2 µm (8 microinches) Au over Ni / <i>Au über Ni</i>	Cu-alloy <i>Kupferlegierung</i>	5 µm (200 microinches) Sn over Ni / <i>Sn über Ni</i>	•	Low cost
106	Cu-alloy <i>Kupferlegierung</i>	0,2 µm (8 microinches) Au over Ni / <i>Au über Ni</i>	Cu-alloy <i>Kupferlegierung</i>	0,2 µm (8 microinches) Au over Ni / <i>Au über Ni</i>	•	Low cost crimp connection <i>Low cost Crimpanschluss</i>
113	Cu-alloy <i>Kupferlegierung</i>	1,3 µm (50 microinches) Au over Ni / <i>Au über Ni</i>	Cu-alloy <i>Kupferlegierung</i>	5 µm (200 microinches) Sn over Ni / <i>Sn über Ni</i>	•	
133	Cu-alloy <i>Kupferlegierung</i>	5 µm (200 microinches) Au over Cu / <i>Au über Cu</i>	Cu-alloy <i>Kupferlegierung</i>	5 µm (200 microinches) Sn over Ag over Cu / <i>Sn über Ag über Cu</i>	•	Non-magnetic
140	Cu-alloy <i>Kupferlegierung</i>	0,2 µm (8 microinches) Au over Ni / <i>Au über 2 µm Ni</i>	Cu-alloy <i>Kupferlegierung</i>	1 - 1,5 µm (40 - 60 microinches) Sn over Ni / <i>Sn über Ni</i>	•	Low cost press-fit <i>Low cost Einpresstechnik</i>
141	Cu-alloy <i>Kupferlegierung</i>	0,8 µm (30 microinches) Au over Ni / <i>Au über Ni</i>	Cu-alloy <i>Kupferlegierung</i>	1 - 1,5 µm (40 - 60 microinches) Sn over Ni / <i>Sn über Ni</i>	•	Standard press-fit <i>Standard Einpresstechnik</i>
187	Cu-alloy <i>Kupferlegierung</i>	0,8 µm (30 microinches) Au over Cu / <i>Au über Cu</i>	Cu-alloy <i>Kupferlegierung</i>	0,2 µm (8 microinches) Au over Cu / <i>Au über Cu</i>	•	Intermodulation sensitive
203	Cu-alloy <i>Kupferlegierung</i>	0,1 µm (4 microinches) Au over NiP / <i>Au über NiP</i>	Cu-alloy <i>Kupferlegierung</i>	5 µm (200 microinches) Sn over Ni / <i>Sn über Ni</i>	•	AuroPur / Tin
204	Cu-alloy <i>Kupferlegierung</i>	0,1 µm (4 microinches) Au over NiP / <i>Au über NiP</i>	Cu-alloy <i>Kupferlegierung</i>	0,2 µm (8 microinches) Au over Ni / <i>Au über Ni</i>	•	AuroPur

Further platings on request / *Weitere Oberflächen auf Anfrage*

Wire Cross-section

Leiterquerschnitt

AWG	Wire Cross-section / <i>Leiterquerschnitt</i>										
	8	10	12	14	16	18	20	22	24	26	28
Wire Construction, n x conductor diameter <i>Leiteraufbau, n x Drahtdurchmesser</i>	133 x 0,29	37 x 0,4	19 x 0,46	19 x 0,36	19 x 0,29	19 x 0,25	19 x 0,20	19 x 0,16	19 x 0,13	19 x 0,10	19 x 0,08
Metrical cross-section (mm ²) <i>metrischer Querschnitt (mm²)</i>	8,60	4,75	3,09	1,95	1,23	0,96	0,62	0,38	0,24	0,16	0,09
Wire outer diameter <i>Außendurchmesser Leiter</i>	3,73	2,92	2,37	1,85	1,47	1,25	0,94	0,79	0,61	0,51	0,41

Coaxial Contacts

Koaxialkontakte

Technical Data

Technische Daten

Mechanical Data

Mechanische Daten

Mechanical Data Mechanische Daten	
Mating and unmating force (pair of contacts) Steck- und Ziehkräfte (Kontaktpaar)	≤ 7 N
Recommended temperature range Empfohlener Temperaturbereich	-55 °C bis 135 °C (-67 °F to 275 °F)
Mating cycles (Standard) Steckzyklen (Standard)	≥ 500
Mating cycles (low cost) Steckzyklen (Low cost)	≥ 200

Electrical Data

Elektrische Daten

Electrical Data Elektrische Daten	
Characteristic impedance Wellenwiderstand	50 Ω / 75 Ω
Insulation resistance Isolationswiderstand	≥ 10 G Ω
Contact resistance inner conductor Durchgangswiderstand Innenleiter	≤ 2,7 mΩ
Contact resistance outer conductor Durchgangswiderstand Außenleiter	≤ 2,7 mΩ
Dielectric withstanding voltage Spannungsfestigkeit	750 V / 50 Hz
Working voltage Betriebsspannung	250 Vrms
Current rating (DC) Max. Kontaktstrom (DC)	2 A

Materials

Materialien

Materials Materialien	
Outer conductor Außenleiter	Cu alloy Cu Legierung
Inner conductor Innenleiter	Cu alloy Cu Legierung
Retaining clip Halteclip	Cu alloy Cu Legierung
Insulators Isolierteile	PTFE / PBTP / PI

VSWR Measurements (Examples)

VSWR Messungen (Beispiele)

VSWR

VSWR

The ratio of the maximum to minimum value of the voltage amplitude on a lead is known as the VSWR value. The quotient is a measurement of the quality of the adaptation or of the fluctuation of the resulting voltage surge. In the case of a mismatch, the outward wave is reflected onto the contact point. By superimposing the outward and return waves, a greater difference is obtained between the maximum and minimum voltage than for the outward wave. The VSWR value is 1.0 for a perfect adaptation. The reciprocal value is known as the adaptation factor m .

Das Verhältnis von Maximal- zu Minimalwert der Spannungsamplitude auf einer Leitung wird mit VSWR Wert bezeichnet. Der Quotient ist ein Maß für die Qualität der Anpassung bzw. der Welligkeit der resultierenden Spannungswelle. Bei Fehlanpassung wird die hinlaufende Welle an der Kontaktstelle reflektiert. Durch die Überlagerung der hinlaufenden und der rücklaufenden Spannungswelle ergibt sich für die resultierende ein größerer Unterschied zwischen der maximalen und der minimalen Spannungsamplitude als bei der hinlaufenden Welle. Der VSWR-Wert ist im Idealfall der Anpassung gleich 1.0, den Kehrwert bezeichnet man als Anpassungsfaktor m .

r : Reflection factor / Reflexionsfaktor

m : Adaptation factor / Anpassungsfaktor

a : Return loss / Rückflußdämpfung

VSWR: Voltage standing wave ratio / Stehwellenverhältnis

$$VSWR = \frac{U_{\max}}{U_{\min}} = \frac{1+r}{1-r} \quad r = \frac{VSWR - 1}{VSWR + 1} \quad m = \frac{1}{VSWR} \quad a = -20 \lg \frac{VSWR + 1}{VSWR - 1}$$

FMS001P102 / ...S102 (Straight Contacts / gerade Kontakte)

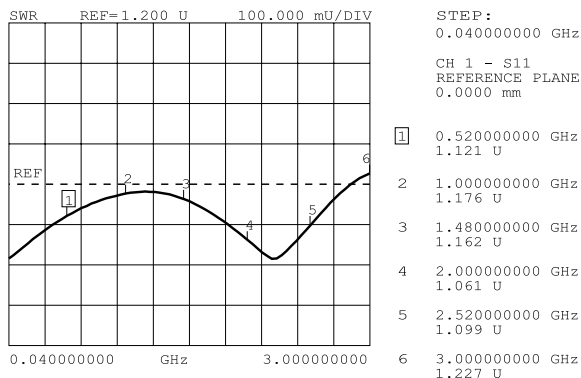

FMS015P102/ ...S102 (Right Angled Contacts / abgewinkelte Kontakte)

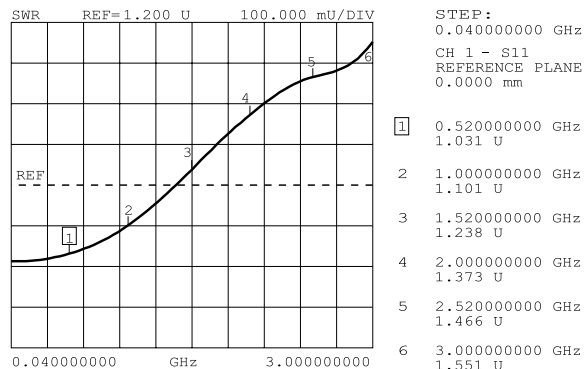

FBM004P170 / ...S170 (Straight Contacts / gerade Kontakte)

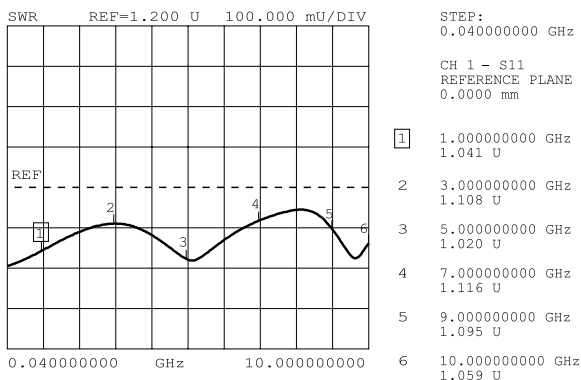

FMX006P102 / ...S102 (Straight Contacts / gerade Kontakte)

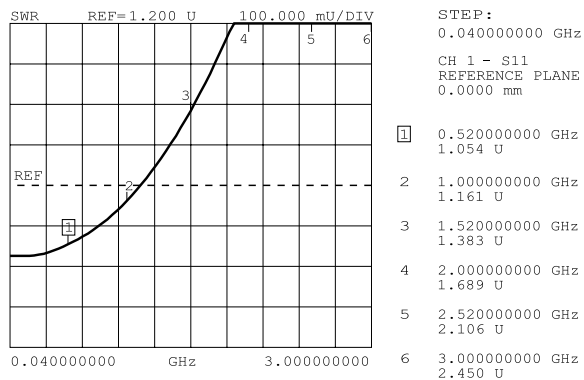



Coaxial Contacts, Mating Area Dimensions, Pin Diameter 1 mm (0.039")

Koaxialkontakte, Abmessungen Steckbereich, Pindurchmesser 1 mm

Plug

Stecker

Socket

Buchse

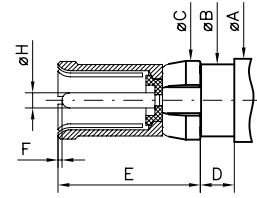
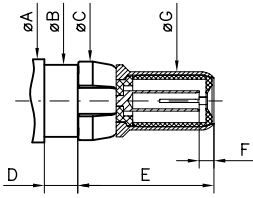

	Plug / <i>Stecker</i>		Socket / <i>Buchse</i>			
	min	max.	min		max.	
			Modi. U*		Modi. U*	
ØA	—	5,50 (0.217)	—		5,50 (0.217)	
ØB	4,75 (0.187)	4,80 (0.189)	4,75 (0.187)		4,80 (0.189)	
ØC	5,00 (0.197)	5,40 (0.213)	5,00 (0.197)		5,40 (0.213)	
D	2,25 (0.089)	2,45 (0.096)	2,25 (0.089)	2,10 (0.083)	2,45 (0.096)	2,25 (0.089)
E	—	9,00 (0.354)	—		9,5 (0.374)	
F	—	approx. 1,0 ca. 1,0	0,10 (0.004)		0,50 (0.020)	
ØG	3,83 (0.151)	3,87 (0.152)	—		—	
ØH	—	—	0,98 (0.039)		1,02 (0.040)	

Modification U* please see page 26

Modifikation U siehe Seite 26*



FMX Coaxial Contacts, 50 Ohm, Straight Cable Termination

FMX Koaxialkontakte, 50 Ohm, gerader Kabelanschluss

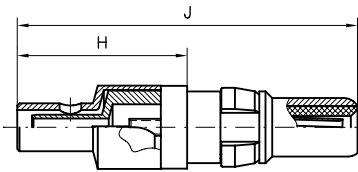

Inner Conductor <i>Innenleiter</i>	Outer Conductor <i>Außenleiter</i>
Solder termination <i>Löten</i>	Crimp or solder termination <i>Crimpen oder Löten</i>

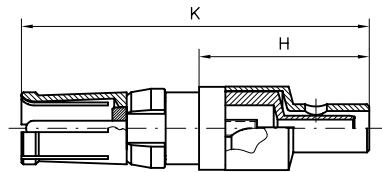

Order Number Plug <i>Bestellnummer Stecker</i>	Type <i>Ausführung</i>	Platings / <i>Oberflächen</i>				Suitable Cables RG- <i>Verwendbare Kabel RG-</i>	Order Number Receptacles <i>Bestellnummer Steckdose</i>
		Mating Area <i>Steckbereich</i>		Termination Area <i>Anschlussbereich</i>			
		Inner Conductor <i>Innenleiter</i>	Outer Conductor <i>Außenleiter</i>	Inner Conductor <i>Innenleiter</i>	Outer Conductor <i>Außenleiter</i>		
FMX005P102	standard	1,3 µm Au	0,8 µm Au	1,3 µm Au	0,2 µm Au	178BU	FMX005S102
FMX005P101	low cost	0,2 µm Au	0,2 µm Au	0,2 µm Au	5 µm Sn	196AU, 404U	FMX005S101
FMX005P202	standard	AuroPur	AuroPur	AuroPur	0,2 µm Au	178BU	FMX005S202
FMX005P201	low cost	AuroPur	AuroPur	AuroPur	5 µm Sn	196AU, 404U	FMX005S201
FMX006P102*	standard	1,3 µm Au	0,8 µm Au	1,3 µm Au	0,2 µm Au	174U	FMX006S102*
FMX006P101*	low cost	0,2 µm Au	0,2 µm Au	0,2 µm Au	5 µm Sn	188AU, 316U	FMX006S101*
FMX007P102*	standard	1,3 µm Au	0,8 µm Au	1,3 µm Au	0,2 µm Au	180BU	FMX007S102*
FMX007P101*	low cost	0,2 µm Au	0,2 µm Au	0,2 µm Au	5 µm Sn		FMX007S101*
FMX008P102	standard	1,3 µm Au	0,8 µm Au	1,3 µm Au	0,2 µm Au	58CU, 141AU	FMX008S102
FMX008P101	low cost	0,2 µm Au	0,2 µm Au	0,2 µm Au	5 µm Sn		FMX008S101
FMX012P102	standard	1,3 µm Au	0,8 µm Au	1,3 µm Au	0,2 µm Au	316U double braided <i>doppelt geschirmt</i>	FMX012S102
FMX012P101	low cost	0,2 µm Au	0,2 µm Au	0,2 µm Au	5 µm Sn		FMX012S101

Other platings on request / *Andere Oberflächen auf Anfrage*
Tools from page 94 onwards / *Werkzeuge ab Seite 94 ff.*

8 microinches = $\approx 0,2 \mu\text{m}$
30 microinches = $\approx 0,8 \mu\text{m}$

50 microinches = $\approx 1,3 \mu\text{m}$
200 microinches = $\approx 5 \mu\text{m}$

* Deep-drawn crimp ferrule without inspection hole, please see illustration on page 32.
* *Tiefgezogene Crimphülse ohne Inspektionsbohrung, siehe Darstellung auf Seite 32.*

Dimensions

Abmessungen

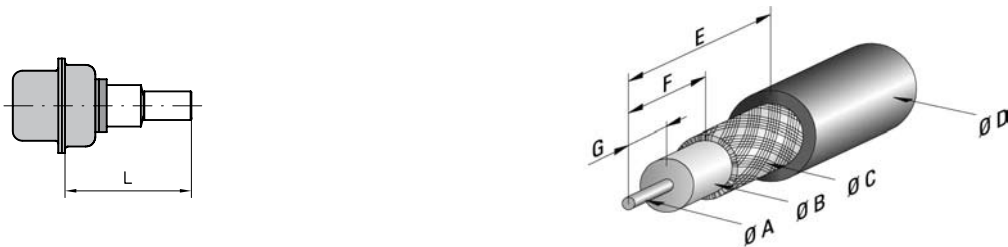

Order Number <i>Bestellnummer</i>	Ø A max.	Ø B max.	Ø C max.	Ø D max.	E	F	G	H	J	K	L
FMX005...	0,85 (0.033)	1,2 (0.047)	1,4 (0.055)	2,3 (0.091)	9,5 (0.374)	5,0 (0.197)	3,0 (0.118)	11,2 (0.441)	22,5 (0.886)	23,0 (0.906)	16,7 (0.657)
FMX006...	0,85 (0.033)	1,9 (0.075)	2,3 (0.091)	3,2 (0.126)	9,5 (0.374)	5,0 (0.197)	3,0 (0.118)	11,2 (0.441)	22,5 (0.886)	23,0 (0.906)	16,7 (0.657)
FMX007...	0,85 (0.033)	2,8 (0.110)	3,1 (0.122)	4,5 (0.177)	9,5 (0.374)	5,0 (0.197)	3,0 (0.118)	11,2 (0.441)	22,5 (0.886)	23,0 (0.906)	16,7 (0.657)
FMX008...	1,0 (0.039)	3,0 (0.118)	3,6 (0.142)	5,2 (0.205)	9,5 (0.374)	5,0 (0.197)	3,0 (0.118)	13,6 (0.535)	26,3 (1.035)	26,8 (1.055)	19,0 (0.748)
FMX012...	0,85 (0.033)	1,9 (0.075)	2,7 (0.106)	3,2 (0.126)	9,5 (0.374)	5,0 (0.197)	3,0 (0.118)	12,2 (0.480)	23,5 (0.925)	24,0 (0.945)	17,3 (0.681)



FMX Coaxial Contacts, 50 Ohm, Right Angled Cable Termination

FMX Koaxialkontakte, 50 Ohm, abgewinkelter Kabelanschluss

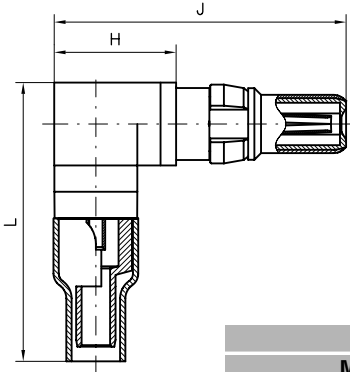

Inner Conductor <i>Innenleiter</i>	Outer Conductor <i>Außenleiter</i>
Solder termination <i>Löten</i>	Crimp or solder termination <i>Crimpen oder Löten</i>

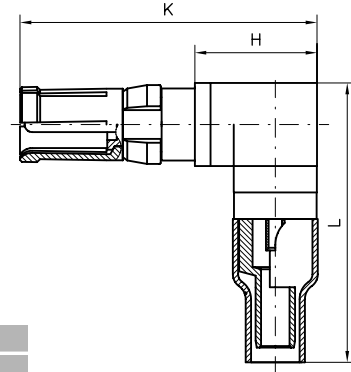

Platings / Oberflächen

Order Number Plug <i>Bestellnummer Stecker</i>	Type <i>Ausführung</i>	Mating Area <i>Steckbereich</i>		Termination Area <i>Anschlussbereich</i>		Suitable Cables RG- <i>Verwendbare Kabel RG-</i>	Order Number Receptacles <i>Bestellnummer Steckdose</i>
		Inner Conductor <i>Innenleiter</i>	Outer Conductor <i>Außenleiter</i>	Inner Conductor <i>Innenleiter</i>	Outer Conductor <i>Außenleiter</i>		
FMX029P102	standard	1,3 µm Au	0,8 µm Au	1,3 µm Au	0,2 µm Au	174U,	FMX029S102
FMX029P101	low cost	0,2 µm Au	0,2 µm Au	0,2 µm Au	5 µm Sn	188AU, 316U	FMX029S101
FMX029P202	standard	AuroPur	AuroPur	AuroPur	0,2 µm Au	174U,	FMX029S202
FMX029P201	low cost	AuroPur	AuroPur	AuroPur	5 µm Sn	188AU, 316U	FMX029S201
FMX031P102*	standard	1,3 µm Au	0,8 µm Au	1,3 µm Au	0,2 µm Au	178BU,	FMX031S102*
FMX031P101*	low cost	0,2 µm Au	0,2 µm Au	0,2 µm Au	5 µm Sn	196AU, 404U	FMX031S101*
FMX032P102*	standard	1,3 µm Au	0,8 µm Au	1,3 µm Au	0,2 µm Au	316U double braided	FMX032S102*
FMX032P101*	low cost	0,2 µm Au	0,2 µm Au	0,2 µm Au	5 µm Sn	<i>doppelt geschirmt</i>	FMX032S101*

Other platings on request / *Andere Oberflächen auf Anfrage*
 Tools from page 94 onwards / *Werkzeuge ab Seite 94 ff.*

8 microinches = $\approx 0,2 \mu\text{m}$
 30 microinches = $\approx 0,8 \mu\text{m}$

50 microinches = $\approx 1,3 \mu\text{m}$
 200 microinches = $\approx 5 \mu\text{m}$

* Turned crimp ferrule with inspection hole, please see illustration on page 31.
 * *Gedrehte Crimphülse mit Inspektionsbohrung, siehe Darstellung auf Seite 31.*

Dimensions

Abmessungen

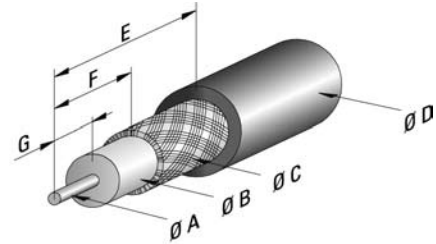
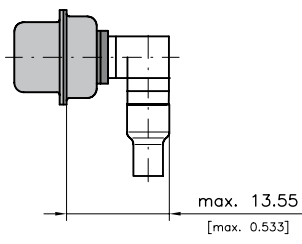

Order Number <i>Bestellnummer</i>	Ø A max.	Ø B max.	Ø C max.	Ø D max.	E	F	G	H	J	K	L
FMX029...	0,85 (0.033)	1,9 (0.075)	2,3 (0.091)	3,2 (0.126)	9,5 (0.374)	5,0 (0.197)	3,0 (0.118)	8,00 (0.315)	19,3 (0.760)	19,8 (0.780)	18,5 (0.728)
FMX031...	0,85 (0.033)	1,2 (0.047)	1,4 (0.055)	2,3 (0.091)	9,5 (0.374)	5,0 (0.197)	3,0 (0.118)	8,00 (0.315)	19,3 (0.760)	19,8 (0.780)	18,5 (0.728)
FMX032...	0,85 (0.033)	1,9 (0.075)	2,7 (0.106)	3,2 (0.126)	9,5 (0.374)	5,0 (0.197)	3,0 (0.118)	8,00 (0.315)	19,3 (0.760)	19,8 (0.780)	19,5 (0.768)



FMX Coaxial Contacts, 75 Ohm, Straight Cable Termination

FMX Koaxialkontakte, 75 Ohm, gerader Kabelanschluss

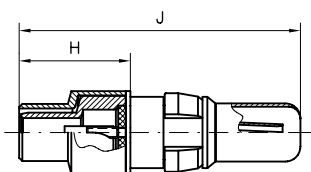

Inner Conductor <i>Innenleiter</i>	Outer Conductor <i>Außenleiter</i>
Solder termination <i>Löten</i>	Crimp or solder termination <i>Crimpen oder Löten</i>

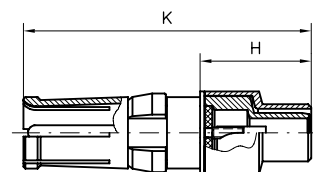

Order Number Plug <i>Bestellnummer Stecker</i>	Type <i>Ausführung</i>	Platings / <i>Oberflächen</i>				Suitable Cables RG- <i>Verwendbare Kabel RG-</i>	Order Number Receptacles <i>Bestellnummer Steckdose</i>
		Mating Area <i>Steckbereich</i>		Termination Area <i>Anschlussbereich</i>			
		Inner Conductor <i>Innenleiter</i>	Outer Conductor <i>Außenleiter</i>	Inner Conductor <i>Innenleiter</i>	Outer Conductor <i>Außenleiter</i>		
FMX002P102 *	standard	1,3 µm Au	0,8 µm Au	1,3 µm Au	0,2 µm Au	179BU, 187AU	FMX002S102 *
FMX002P101 *	low cost	0,2 µm Au	0,2 µm Au	0,2 µm Au	5 µm Sn		FMX002S101 *
FMX002P202 *	standard	AuroPur	AuroPur	AuroPur	0,2 µm Au	179BU, 187AU	FMX002S202 *
FMX002P201 *	low cost	AuroPur	AuroPur	AuroPur	5 µm Sn		FMX002S201 *
FMX003P102 **	standard	1,3 µm Au	0,8 µm Au	1,3 µm Au	0,2 µm Au	179BU, 187AU	FMX003S102 **
FMX003P101 **	low cost	0,2 µm Au	0,2 µm Au	0,2 µm Au	5 µm Sn		FMX003S101 **

Other platings on request / *Andere Oberflächen auf Anfrage*

Tools from page 94 onwards / *Werkzeuge ab Seite 94 ff*

8 microinches = $\approx 0,2 \mu\text{m}$

30 microinches = $\approx 0,8 \mu\text{m}$

50 microinches = $\approx 1,3 \mu\text{m}$

200 microinches = $\approx 5 \mu\text{m}$

* Short version / *kurze Version*

** Deep-drawn crimp ferrule without inspection hole, please see illustration on page 32.

** *Tiefgezogene Crimphülse ohne Inspektionsbohrung, siehe Darstellung auf Seite 32.*

Dimensions

Abmessungen

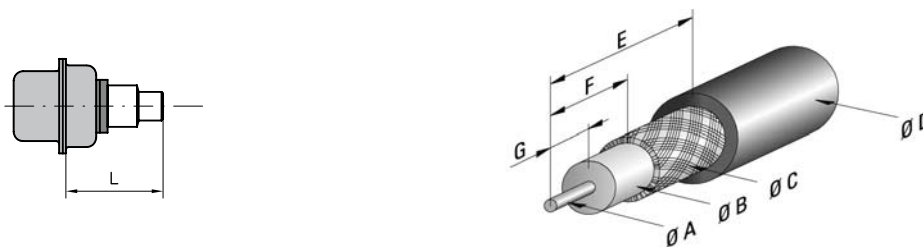

Order Number <i>Bestellnummer</i>	Ø A max.	Ø B max.	Ø C max.	Ø D max.	E	F	G	H	J	K	L
FMX002...	0,5 (0.020)	1,9 (0.075)	2,3 (0.091)	3,2 (0.126)	6,0 (0.236)	3,1 (0.122)	2,0 (0.079)	7,3 (0.287)	18,55 (0.730)	19,05 (0.750)	12,8 (0.504)
FMX003...	0,5 (0.020)	1,9 (0.075)	2,3 (0.091)	3,2 (0.126)	9,5 (0.374)	5,0 (0.197)	3,0 (0.118)	11,2 (0.441)	22,5 (0.886)	23,0 (0.906)	16,7 (0.657)



FMS Coaxial Contacts, 50 Ohm, Straight Cable Termination

FMS Koaxialkontakte, 50 Ohm, gerader Kabelanschluss

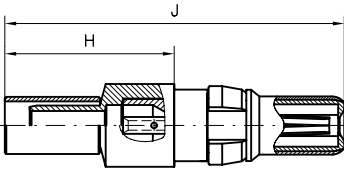

Inner Conductor <i>Innenleiter</i>	Outer Conductor <i>Außenleiter</i>
Crimp termination <i>Crimpen</i>	Crimp termination <i>Crimpen</i>
Crimp snap-in system <i>Crimp Snap-in System</i>	

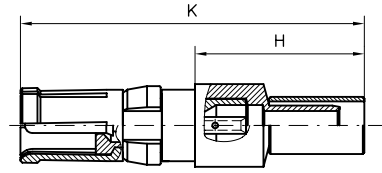

Platings / Oberflächen

Mating Area <i>Steckbereich</i>		Termination Area <i>Anschlussbereich</i>	
Inner Conductor <i>Innenleiter</i>	Outer Conductor <i>Außenleiter</i>	Inner Conductor <i>Innenleiter</i>	Outer Conductor <i>Außenleiter</i>

Order Number Plug <i>Bestellnummer Stecker</i>	Type <i>Ausführung</i>	Inner Conductor <i>Innenleiter</i>	Outer Conductor <i>Außenleiter</i>	Inner Conductor <i>Innenleiter</i>	Outer Conductor <i>Außenleiter</i>	Suitable Cables RG- <i>Verwendbare Kabel RG-</i>	Order Number Receptacles <i>Bestellnummer Steckdose</i>
FMS001P102	standard	1,3 µm Au	0,8 µm Au	1,3 µm Au	0,2 µm Au	174U,	FMS001S102
FMS001P101	low cost	0,2 µm Au	0,2 µm Au	0,2 µm Au	5 µm Sn	188AU, 316U	FMS001S101
FMS001P202	standard	AuroPur	AuroPur	AuroPur	0,2 µm Au	174U,	FMS001S202
FMS001P201	low cost	AuroPur	AuroPur	AuroPur	5 µm Sn	188AU, 316U	FMS001S201
FMS006P102	standard	1,3 µm Au	0,8 µm Au	1,3 µm Au	0,2 µm Au	316U double braided <i>doppelt geschirmt</i>	FMS006S102
FMS006P101	low cost	0,2 µm Au	0,2 µm Au	0,2 µm Au	5 µm Sn		FMS006S101
FMS009P102	standard	1,3 µm Au	0,8 µm Au	1,3 µm Au	0,2 µm Au	58CU, 141AU	FMS009S102
FMS009P101	low cost	0,2 µm Au	0,2 µm Au	0,2 µm Au	5 µm Sn		FMS009S101

Other platings on request / *Andere Oberflächen auf Anfrage*
 Tools from page 94 onwards / *Werkzeuge ab Seite 94 ff.*

8 microinches = $\approx 0,2 \mu\text{m}$
 30 microinches = $\approx 0,8 \mu\text{m}$

50 microinches = $\approx 1,3 \mu\text{m}$
 200 microinches = $\approx 5 \mu\text{m}$

Dimensions

Abmessungen

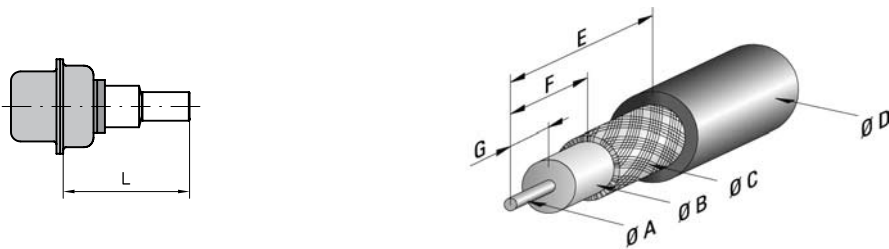

Order Number <i>Bestellnummer</i>	Ø A max.	Ø B max.	Ø C max.	Ø D max.	E	F	G	H approx. ca.	J approx. ca.	K approx. ca.	L
FMS001...	0,6 (0.024)	1,9 (0.075)	2,4 (0.094)	3,2 (0.126)	9,0 (0.354)	4,3 (0.169)	3,0 (0.118)	11,2 (0.441)	22,45 (0.884)	22,95 (0.904)	16,6 (0.654)
FMS006...	0,6 (0.024)	1,9 (0.075)	2,7 (0.106)	3,8 (0.150)	9,3 (0.366)	4,3 (0.169)	3,0 (0.118)	11,2 (0.441)	22,45 (0.884)	22,95 (0.904)	16,6 (0.654)
FMS009...	1,3 (0.051)	3,7 (0.146)	4,5 (0.177)	5,2 (0.205)	8,3 (0.327)	3,6 (0.142)	2,7 (0.106)	10,7 (0.421)	22,15 (0.872)	22,65 (0.892)	16,3 (0.642)



FMS Coaxial Contacts, 50 Ohm, Right Angled Cable Termination

FMS Koaxialkontakte, 50 Ohm, abgewinkelter Kabelanschluss

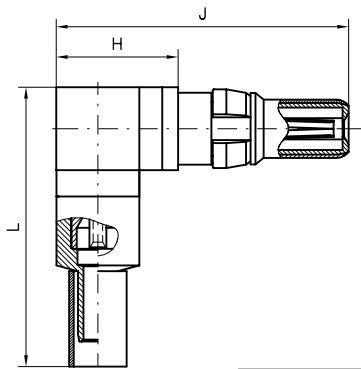

Inner Conductor
Innenleiter
Outer Conductor
Außenleiter
Crimp termination
Crimpen
Crimp termination
Crimpen
Crimp snap-in system
Crimp Snap-in System

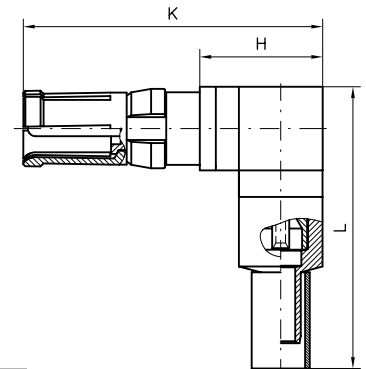

Order Number Plug <i>Bestellnummer Stecker</i>	Type <i>Ausführung</i>	Platings / <i>Oberflächen</i>				Suitable Cables RG- <i>Verwendbare Kabel RG-</i>	Order Number Receptacles <i>Bestellnummer Steckdose</i>
		Mating Area <i>Steckbereich</i>		Termination Area <i>Anschlussbereich</i>			
		Inner Conductor <i>Innenleiter</i>	Outer Conductor <i>Außenleiter</i>	Inner Conductor <i>Innenleiter</i>	Outer Conductor <i>Außenleiter</i>		
FMS012P102	standard	1,3 μm Au	0,8 μm Au	1,3 μm Au	0,2 μm Au	174U	FMS012S102
FMS012P101	low cost	0,2 μm Au	0,2 μm Au	0,2 μm Au	5 μm Sn	188AU, 316U	FMS012S101
FMS012P202	standard	AuroPur	AuroPur	AuroPur	0,2 μm Au	174U	FMS012S202
FMS012P201	low cost	AuroPur	AuroPur	AuroPur	5 μm Sn	188AU, 316U	FMS012S201
FMS022P102	standard	1,3 μm Au	0,8 μm Au	1,3 μm Au	0,2 μm Au	316U double braided <i>doppelt geschirmt</i>	FMS022S102
FMS022P101	low cost	0,2 μm Au	0,2 μm Au	0,2 μm Au	5 μm Sn		FMS022S101
FMS026P102	standard	1,3 μm Au	0,8 μm Au	1,3 μm Au	0,2 μm Au	58 C/U	FMS026S102
FMS026P101	low cost	0,2 μm Au	0,2 μm Au	0,2 μm Au	5 μm Sn		FMS026S101

Other platings on request / *Andere Oberflächen auf Anfrage*
 Tools from page 94 onwards / *Werkzeuge ab Seite 94 ff.*

8 microinches = $\approx 0,2 \mu\text{m}$
 30 microinches = $\approx 0,8 \mu\text{m}$

50 microinches = $\approx 1,3 \mu\text{m}$
 200 microinches = $\approx 5 \mu\text{m}$

Dimensions

Abmessungen

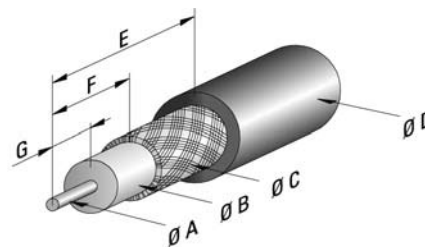
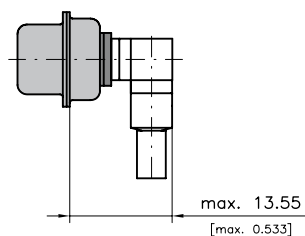

Order Number <i>Bestellnummer</i>	Ø A max.	Ø B max.	Ø C max.	Ø D max.	E	F	G	H	J	K	L approx. ca.
FMS012...	0,6 (0.024)	1,9 (0.075)	2,3 (0.091)	3,2 (0.126)	9,0 (0.354)	3,8 (0.150)	2,3 (0.091)	8,0 (0.315)	19,25 (0.758)	19,8 (0.780)	18,5 (0.728)
FMS022...	0,6 (0.024)	1,9 (0.075)	3,0 (0.118)	3,5 (0.138)	9,0 (0.354)	3,8 (0.150)	2,3 (0.091)	8,05 (0.317)	19,3 (0.760)	19,8 (0.780)	18,5 (0.728)
FMS026...	1,0 (0.039)	3,7 (0.146)	4,3 (0.169)	5,2 (0.205)	8,3 (0.327)	3,6 (0.142)	2,7 (0.106)	8,05 (0.317)	19,3 (0.760)	19,8 (0.780)	18,5 (0.728)



FMS Coaxial Contacts, 75 Ohm, Straight Cable Termination

FMS Koaxialkontakte, 75 Ohm, gerader Kabelanschluss

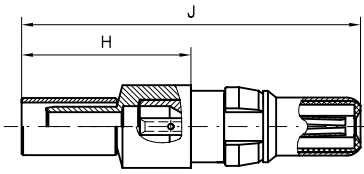

Inner Conductor <i>Innenleiter</i>	Outer Conductor <i>Außenleiter</i>
Crimp termination <i>Crimpen</i>	Crimp termination <i>Crimpen</i>
Crimp snap-in system <i>Crimp Snap-in System</i>	

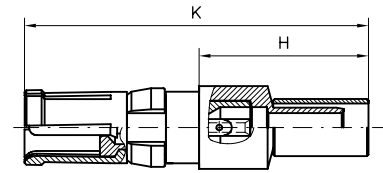

Platings / Oberflächen

Mating Area <i>Steckbereich</i>		Termination Area <i>Anschlussbereich</i>	
Inner Conductor <i>Innenleiter</i>	Outer Conductor <i>Außenleiter</i>	Inner Conductor <i>Innenleiter</i>	Outer Conductor <i>Außenleiter</i>

Order Number Plug <i>Bestellnummer Stecker</i>	Type <i>Ausführung</i>	Inner Conductor <i>Innenleiter</i>	Outer Conductor <i>Außenleiter</i>	Inner Conductor <i>Innenleiter</i>	Outer Conductor <i>Außenleiter</i>	Suitable Cables RG- <i>Verwendbare Kabel RG-</i>	Order Number Receptacles <i>Bestellnummer Steckdose</i>
FMS002P102	standard	1,3 µm Au	0,8 µm Au	1,3 µm Au	0,2 µm Au	179BU, 187AU	FMS002S102
FMS002P101	low cost	0,2 µm Au	0,2 µm Au	0,2 µm Au	5 µm Sn		FMS002S101
FMS002P202	standard	AuroPur	AuroPur	AuroPur	0,2 µm Au	179BU, 187AU	FMS002S202
FMS002P201	low cost	AuroPur	AuroPur	AuroPur	5 µm Sn		FMS002S201
FMS003P102	standard	1,3 µm Au	0,8 µm Au	1,3 µm Au	0,2 µm Au	180BU	FMS003S102
FMS003P101	low cost	0,2 µm Au	0,2 µm Au	0,2 µm Au	5 µm Sn		FMS003S101

Other platings on request / *Andere Oberflächen auf Anfrage*
Tools from page 94 onwards / *Werkzeuge ab Seite 94 ff.*

8 microinches = $\approx 0,2 \mu\text{m}$
30 microinches = $\approx 0,8 \mu\text{m}$

50 microinches = $\approx 1,3 \mu\text{m}$
200 microinches = $\approx 5 \mu\text{m}$

Dimensions

Abmessungen

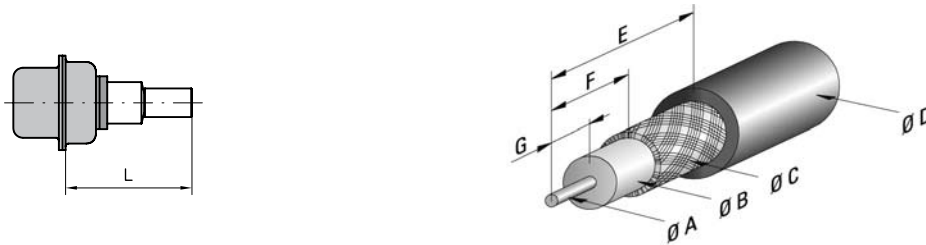

Order Number <i>Bestellnummer</i>	Ø A max.	Ø B max.	Ø C max.	Ø D max.	E	F	G	H approx. ca.	J approx. ca.	K approx. ca.	L
FMS002...	0,6 (0.024)	1,9 (0.075)	2,4 (0.094)	3,2 (0.126)	9,0 (0.354)	4,3 (0.169)	3,0 (0.118)	11,2 (0.441)	22,45 (0.884)	22,95 (0.904)	16,7 (0.657)
FMS003...	0,6 (0.024)	2,8 (0.110)	3,3 (0.130)	4,5 (0.177)	8,5 (0.335)	3,5 (0.138)	3,0 (0.118)	10,2 (0.402)	21,65 (0.852)	22,15 (0.872)	15,9 (0.626)



FMS Coaxial Contacts, 75 Ohm, Right Angled Cable Termination

FMS Koaxialkontakte, 75 Ohm, abgewinkelter Kabelanschluss

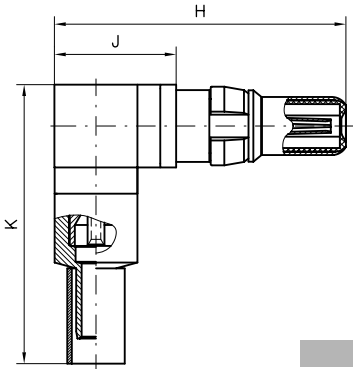

Inner Conductor <i>Innenleiter</i>	Outer Conductor <i>Außenleiter</i>
Crimp termination <i>Crimpen</i>	Crimp termination <i>Crimpen</i>
Crimp snap-in system <i>Crimp Snap-in System</i>	

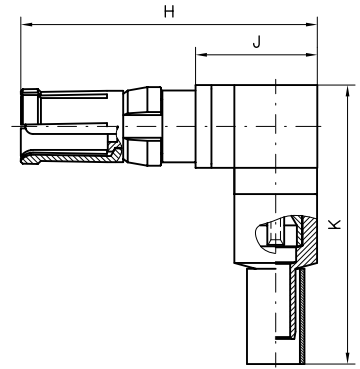

Order Number Plug <i>Bestellnummer Stecker</i>	Type <i>Ausführung</i>	Platings / <i>Oberflächen</i>				Suitable Cables RG- <i>Verwendbare Kabel RG-</i>	Order Number Receptacles <i>Bestellnummer Steckdose</i>
		Mating Area <i>Steckbereich</i>		Termination Area <i>Anschlussbereich</i>			
		Inner Conductor <i>Innenleiter</i>	Outer Conductor <i>Außenleiter</i>	Inner Conductor <i>Innenleiter</i>	Outer Conductor <i>Außenleiter</i>		
FMS015P102	standard	1,3 µm Au	0,8 µm Au	1,3 µm Au	0,2 µm Au	179BU, 187AU	FMS015S102
FMS015P101	low cost	0,2 µm Au	0,2 µm Au	0,2 µm Au	5 µm Sn	179BU, 187AU	FMS015S101
FMS015P202	standard	AuroPur	AuroPur	AuroPur	0,2 µm Au	179BU, 187AU	FMS015S202
FMS015P201	low cost	AuroPur	AuroPur	AuroPur	5 µm Sn	179BU, 187AU	FMS015S201

Other platings on request / *Andere Oberflächen auf Anfrage*
Tools from page 94 onwards / *Werkzeuge ab Seite 94 ff.*

8 microinches = $\approx 0,2 \mu\text{m}$
30 microinches = $\approx 0,8 \mu\text{m}$

50 microinches = $\approx 1,3 \mu\text{m}$
200 microinches = $\approx 5 \mu\text{m}$

Dimensions

Abmessungen

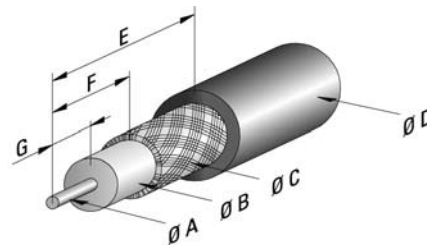
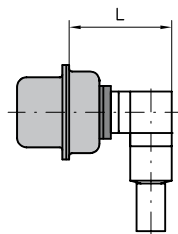

Order Number <i>Bestellnummer</i>	Ø A max.	Ø B max.	Ø C max.	Ø D max.	E	F	G	H	J	K approx. ca.	L
FMS015...	0,6 (0.024)	1,9 (0.075)	2,3 (0.091)	3,2 (0.126)	9,0 (0.354)	3,8 (0.150)	2,3 (0.091)	19,25 (0.758)	8,0 (0.315)	18,5 (0.728)	13,55 (0.533)



Coaxial Contacts, Mating Area Dimensions, Pin Diameter 0.75 mm (0.030")

Koaxialkontakte, Abmessungen Steckbereich, Pindurchmesser 0,75 mm

Plug

Stecker

Socket

Buchse

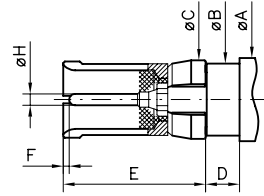
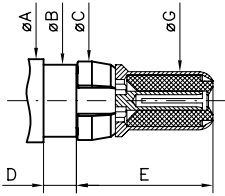

	Plug / Stecker		Socket / Buchse			
	min	max.	min	max.		
				Modi. U*		Modi. U*
ØA	—	5,50 (0.217)	—		5,50 (0.217)	
ØB	4,75 (0.187)	4,80 (0.189)	4,75 (0.187)		4,80 (0.189)	
ØC	5,00 (0.197)	5,40 (0.213)	5,00 (0.197)		5,40 (0.213)	
D	2,25 (0.089)	2,45 (0.096)	2,25 (0.089)	2,10 (0.083)	2,45 (0.096)	2,25 (0.089)
E	—	9,00 (0.354)	—		9,5 (0.374)	
F	—	—	0,10 (0.004)		0,50 (0.020)	
ØG	3,83 (0.151)	3,87 (0.152)	—		—	
ØH	—	—	0,74 (0.029)		0,76 (0.030)	

Modification U* please see page 26

Modifikation U* siehe Seite 26



FMS Coaxial Contacts, 50 Ohm, Straight Cable Termination, Pin Diameter 0.75 mm (0.030")

FMS Koaxialkontakte, 50 Ohm, gerader Kabelanschluss, Pindurchmesser 0,75 mm

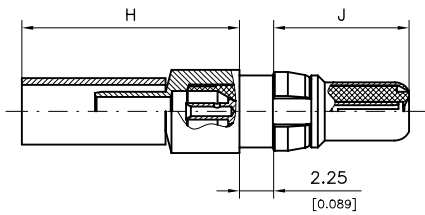

Inner Conductor <i>Innenleiter</i>	Outer Conductor <i>Außenleiter</i>
Crimp termination <i>Crimpen</i>	Crimp termination <i>Crimpen</i>
Crimp snap-in system <i>Crimp Snap-in System</i>	

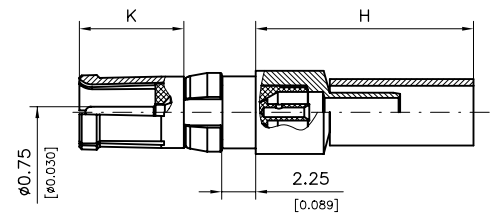

Order Number Plug <i>Bestellnummer Stecker</i>	Type <i>Ausführung</i>	Platings / <i>Oberflächen</i>				Suitable Cables RG- <i>Verwendbare Kabel RG-</i>	Order Number Receptacles <i>Bestellnummer Steckdose</i>
		Mating Area <i>Steckbereich</i>		Termination Area <i>Anschlussbereich</i>			
		Inner Conductor <i>Innenleiter</i>	Outer Conductor <i>Außenleiter</i>	Inner Conductor <i>Innenleiter</i>	Outer Conductor <i>Außenleiter</i>		
FMS016P102	standard	1,3 µm Au	0,8 µm Au	1,3 µm Au	0,2 µm Au	316U double braided <i>doppelt geschirmt</i>	FMS016S102
FMS016P101	low cost	0,2 µm Au	0,2 µm Au	0,2 µm Au	5 µm Sn	316U double braided <i>doppelt geschirmt</i>	FMS016S101
FMS016P202	standard	AuroPur	AuroPur	AuroPur	0,2 µm Au		FMS016S202
FMS016P201	low cost	AuroPur	AuroPur	AuroPur	5 µm Sn		FMS016S201

Other platings on request / *Andere Oberflächen auf Anfrage*
Tools from page 94 onwards / *Werkzeuge ab Seite 94 ff.*

8 microinches = ≈ 0,2 µm
30 microinches = ≈ 0,8 µm
50 microinches = ≈ 1,3 µm
200 microinches = ≈ 5 µm

FMX Coaxial Contacts, 50 Ohm, Straight Cable Termination, Pin Diameter 0.75 mm (0.030")

FMX Koaxialkontakte, 50 Ohm, gerader Kabelanschluss, Pindurchmesser 0,75 mm

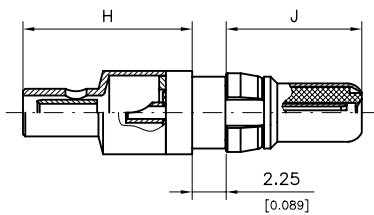

Inner Conductor <i>Innenleiter</i>	Outer Conductor <i>Außenleiter</i>
—	Crimp termination <i>Crimpen</i>
Solder termination <i>Löten</i>	Solder termination <i>Löten</i>

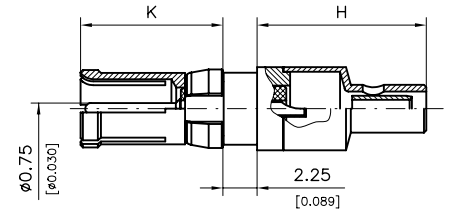

Order Number Plug <i>Bestellnummer Stecker</i>	Type <i>Ausführung</i>	Platings / <i>Oberflächen</i>				Suitable Cables RG- <i>Verwendbare Kabel RG-</i>	Order Number Receptacles <i>Bestellnummer Steckdose</i>
		Mating Area <i>Steckbereich</i>		Termination Area <i>Anschlussbereich</i>			
		Inner Conductor <i>Innenleiter</i>	Outer Conductor <i>Außenleiter</i>	Inner Conductor <i>Innenleiter</i>	Outer Conductor <i>Außenleiter</i>		
FMX058P102	standard	1,3 µm Au	0,8 µm Au	1,3 µm Au	0,2 µm Au	179BU, 196AU, 404U	FMX058S102
FMX058P101	low cost	0,2 µm Au	0,2 µm Au	0,2 µm Au	5 µm Sn	179BU, 196AU, 404U	FMX058S101
FMX058P202	standard	AuroPur	AuroPur	AuroPur	0,2 µm Au		FMX058S202
FMX058P201	low cost	AuroPur	AuroPur	AuroPur	5 µm Sn		FMX058S201

Other platings on request / *Andere Oberflächen auf Anfrage*
Tools from page 94 onwards / *Werkzeuge ab Seite 94 ff.*

8 microinches = ≈ 0,2 µm
30 microinches = ≈ 0,8 µm
50 microinches = ≈ 1,3 µm
200 microinches = ≈ 5 µm

Dimensions

Abmessungen

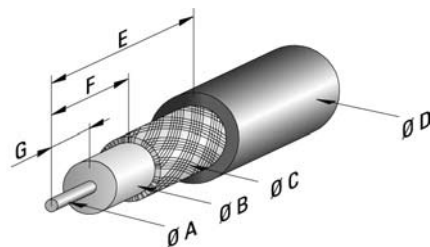
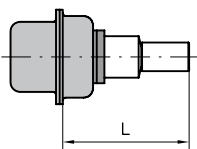

Order Number <i>Bestellnummer</i>	Ø A max.	Ø B max.	Ø C max.	Ø D max.	E	F	G	H approx. ca.	J	K	L
FMS016...	0,6 (0.024)	1,9 (0.075)	2,7 (0.106)	3,5 (0.138)	9,3 (0.366)	4,3 (0.169)	3,0 (0.118)	14,4 (0.567)	9,0 (0.354)	9,5 (0.374)	19,9 (0.783)
FMX058...	0,85 (0.033)	1,2 (0.047)	1,4 (0.055)	2,3 (0.091)	9,5 (0.374)	5,0 (0.197)	3,0 (0.118)	11,2 (0.441)	9,0 (0.354)	9,5 (0.374)	17 (0.669)

Wiresplice

Wiresplice

50 Ohm

50 Ohm

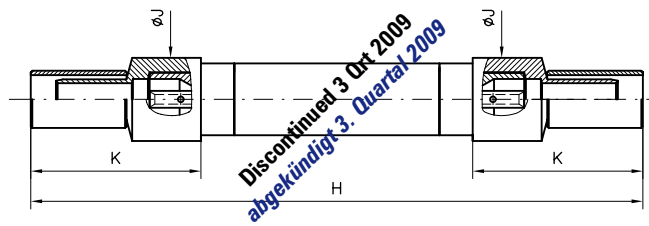

Inner Conductor <i>Innenleiter</i>	Outer Conductor <i>Außenleiter</i>
Crimp termination <i>Crimpen</i>	Crimp termination <i>Crimpen</i>

Order Number <i>Bestellnummer</i>	Type <i>Ausführung</i>	Platings / <i>Oberflächen</i>		Suitable Cables RG- <i>Verwendbare Kabel RG-</i>
		Inner Conductor <i>Innenleiter</i>	Outer Conductor <i>Außenleiter</i>	
FMS010-102	standard	1,3 µm Au	0,2 µm Au	174U, 188AU, 316U
FMS010-101	low cost	0,2 µm Au	5 µm Sn	
FMS030-102	standard	1,3 µm Au	0,2 µm Au	58CU, 141AU
FMS030-101	low cost	0,2 µm Au	5 µm Sn	

Other platings on request

Andere Oberflächen auf Anfrage

Tools from page 94 onwards

Werkzeuge ab Seite 94 ff.

8 microinches = $\approx 0,2 \mu\text{m}$

30 microinches = $\approx 0,8 \mu\text{m}$

50 microinches = $\approx 1,3 \mu\text{m}$

200 microinches = $\approx 5 \mu\text{m}$

Dimensions

Abmessungen

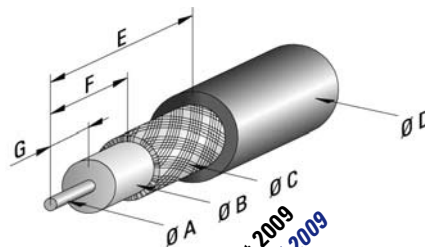

Order Number <i>Bestellnummer</i>	Ø A max.	Ø B max.	Ø C max.	Ø D max.	E	F	G	H approx. ca.	J	K approx. ca.
FMS010...	0,6 (0.024)	1,9 (0.075)	2,4 (0.094)	3,2 (0.126)	9,0 (0.354)	4,3 (0.169)	3,0 (0.118)	40,3 (1.587)	5,50 (0.217)	11,30 (0.445)
FMS030...	1,3 (0.051)	3,7 (0.146)	4,4 (0.173)	5,2 (0.205)	9,0 (0.354)	4,3 (0.169)	3,0 (0.118)	39,7 (1.563)	5,50 (0.217)	11,00 (0.433)



FME Coaxial Contacts, 50 Ohm, Straight PCB Termination, 3 Pins

FME Koaxialkontakte, 50 Ohm, gerader Leiterplattenanschluss, 3 Anschlüsse

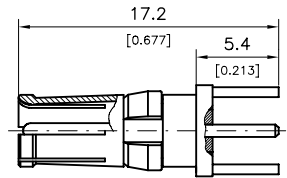
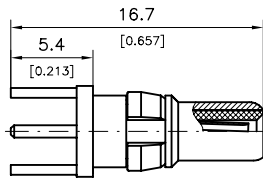

Order Number Plug <i>Bestellnummer Stecker</i>	Type <i>Ausführung</i>	Platings / <i>Oberflächen</i>				Order Number Receptacles <i>Bestellnummer Steckdose</i>
		Mating Area <i>Steckbereich</i>		Termination Area <i>Anschlussbereich</i>		
		Inner Conductor <i>Innenleiter</i>	Outer Conductor <i>Außenleiter</i>	Inner Conductor <i>Innenleiter</i>	Outer Conductor <i>Außenleiter</i>	
FME010P102	standard	1,3 μm Au	0,8 μm Au	1,3 μm Au	0,2 μm Au	FME010S102
FME010P101	low cost	0,2 μm Au	0,2 μm Au	0,2 μm Au	5 μm Sn	FME010S101
FME010P108		1,3 μm Au	0,8 μm Au	1,3 μm Au	5 μm Sn	FME010S108
FME010P202	standard	AuroPur	AuroPur	AuroPur	0,2 μm Au	FME010S202
FME010P201	low cost	AuroPur	AuroPur	AuroPur	5 μm Sn	FME010S201

Other platings on request / *Andere Oberflächen auf Anfrage*

8 microinches = $\approx 0,2 \mu\text{m}$
30 microinches = $\approx 0,8 \mu\text{m}$

50 microinches = $\approx 1,3 \mu\text{m}$
200 microinches = $\approx 5 \mu\text{m}$

Dimensions of an Example Connector with Coaxial Contact FME010P... and Signal Contacts P1

Abmessungen am Beispiel Steckverbinder mit Koaxialkontakt FME010P... und Signalkontakten P1

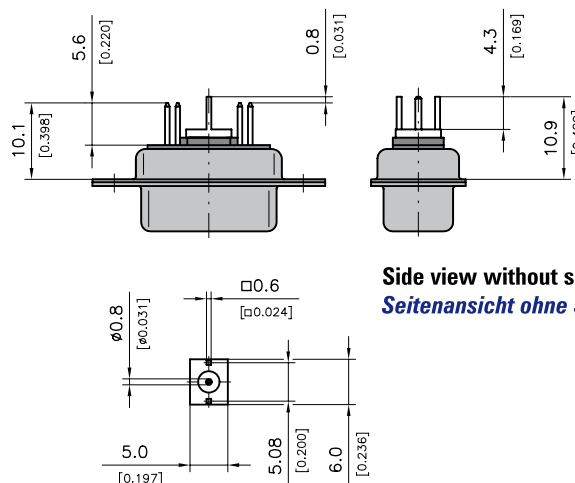

Side view without signal contacts!
Seitenansicht ohne Signalkontakte!



FME Coaxial Contacts, 50 Ohm, Right Angled PCB Termination, 3 Pins

FME Koaxialkontakte, 50 Ohm, abgewinkelter Leiterplattenanschluss, 3 Anschlüsse

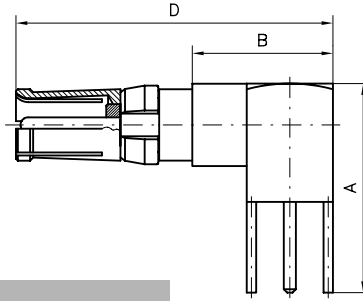
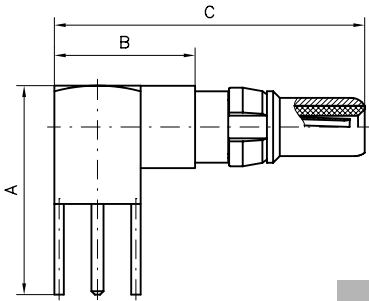

Order Number Plug <i>Bestellnummer Stecker</i>	Type <i>Ausführung</i>	Platings / <i>Oberflächen</i>				Order Number Receptacles <i>Bestellnummer Steckdose</i>
		Mating Area <i>Steckbereich</i>		Termination Area <i>Anschlussbereich</i>		
		Inner Conductor <i>Innenleiter</i>	Outer Conductor <i>Außenleiter</i>	Inner Conductor <i>Innenleiter</i>	Outer Conductor <i>Außenleiter</i>	
FME008P102	standard	1,3 μm Au	0,8 μm Au	1,3 μm Au	0,2 μm Au	FME008S102
FME008P101	low cost	0,2 μm Au	0,2 μm Au	0,2 μm Au	5 μm Sn	FME008S101
FME008P108		1,3 μm Au	0,8 μm Au	1,3 μm Au	5 μm Sn	FME008S108
FME008P202	standard	AuroPur	AuroPur	AuroPur	0,2 μm Au	FME008S202
FME008P201	low cost	AuroPur	AuroPur	AuroPur	5 μm Sn	FME008S201
FME020P102	standard	1,3 μm Au	0,8 μm Au	1,3 μm Au	0,2 μm Au	FME020S102
FME020P101	low cost	0,2 μm Au	0,2 μm Au	0,2 μm Au	5 μm Sn	FME020S101
FME020P108		1,3 μm Au	0,8 μm Au	1,3 μm Au	5 μm Sn	FME020S108

Other platings on request / *Andere Oberflächen auf Anfrage*

8 microinches = $\approx 0,2 \mu\text{m}$

30 microinches = $\approx 0,8 \mu\text{m}$

50 microinches = $\approx 1,3 \mu\text{m}$

200 microinches = $\approx 5 \mu\text{m}$

Type FME020... For use with D-Sub shell size 5 only.

Typ FME020... Nur zur Verwendung in D-Sub Gehäusegröße 5.

Dimensions of an Example Connector with Coaxial Contacts FME008P.. or FME020P.. and Signal Contacts P5

Abmessungen am Beispiel Steckverbinder mit Koaxialkontakten FME008P.. oder FME020P.. und Signalkontakten P5

Order Number <i>Bestellnummer</i>	A	B	C	D
FME008...	13,8 (0.543)	9,3 (0.366)	20,7 (0.815)	21,2 (0.835)
FME020...	16,8 (0.661)	11,8 (0.465)	23,2 (0.913)	23,7 (0.933)

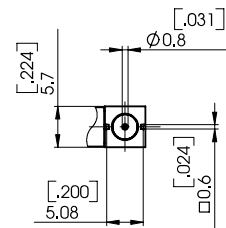

Shell sizes 1 - 4
Gehäusegrößen 1 - 4

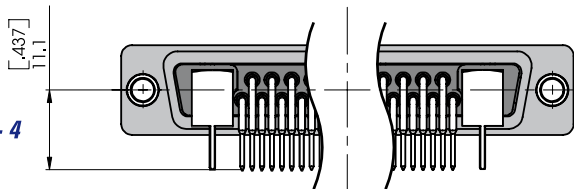

Connector with coaxial contacts FME008P.. and signal contacts P5
Steckverbinder mit Koaxialkontakten FME008P.. und Signalkontakten P5

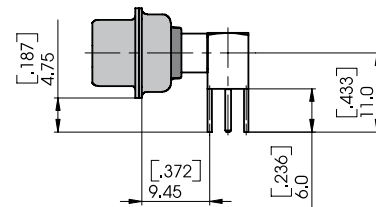

Shell size 5
Gehäusegröße 5

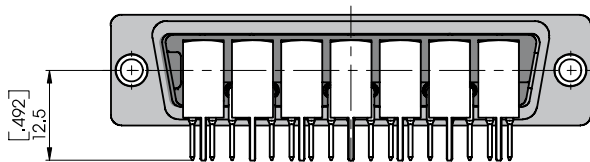

Connector with coaxial contacts FME020P.. and signal contacts P5
Steckverbinder mit Koaxialkontakten FME020P.. und Signalkontakten P5

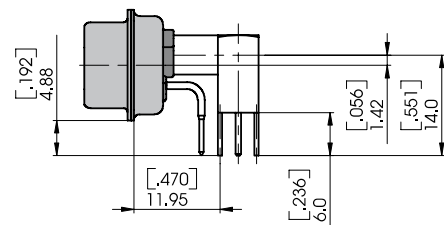



FME Coaxial Contacts, 50 Ohm, Right Angled PCB Termination, 5 Pins

FME Koaxialkontakte, 50 Ohm, abgewinkelter Leiterplattenanschluss, 5 Anschlüsse

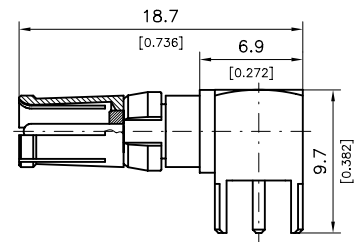
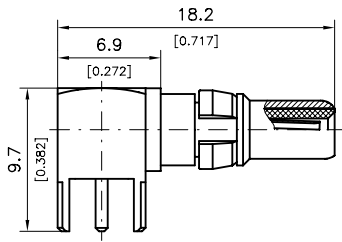

Order Number Plug <i>Bestellnummer Stecker</i>	Type <i>Ausführung</i>	Platings / <i>Oberflächen</i>				Order Number Receptacles <i>Bestellnummer Steckdose</i>
		Mating Area <i>Steckbereich</i>		Termination Area <i>Anschlussbereich</i>		
		Inner Conductor <i>Innenleiter</i>	Outer Conductor <i>Außenleiter</i>	Inner Conductor <i>Innenleiter</i>	Outer Conductor <i>Außenleiter</i>	
FME009P102	standard	1,3 μm Au	0,8 μm Au	1,3 μm Au	0,2 μm Au	FME009S102
FME009P101	low cost	0,2 μm Au	0,2 μm Au	0,2 μm Au	5 μm Sn	FME009S101
FME009P108		1,3 μm Au	0,8 μm Au	1,3 μm Au	5 μm Sn	FME009S108
FME009P202	standard	AuroPur	AuroPur	AuroPur	0,2 μm Au	FME009S202
FME009P201	low cost	AuroPur	AuroPur	AuroPur	5 μm Sn	FME009S201

Other platings on request / *Andere Oberflächen auf Anfrage*

8 microinches = $\approx 0,2 \mu\text{m}$
30 microinches = $\approx 0,8 \mu\text{m}$

50 microinches = $\approx 1,3 \mu\text{m}$
200 microinches = $\approx 5 \mu\text{m}$

Dimensions of an Example Connector with Coaxial Contact FME009P... and Signal Contacts P45

Abmessungen am Beispiel Steckverbinder mit Koaxialkontakt FME009P... und Signalkontakten P45

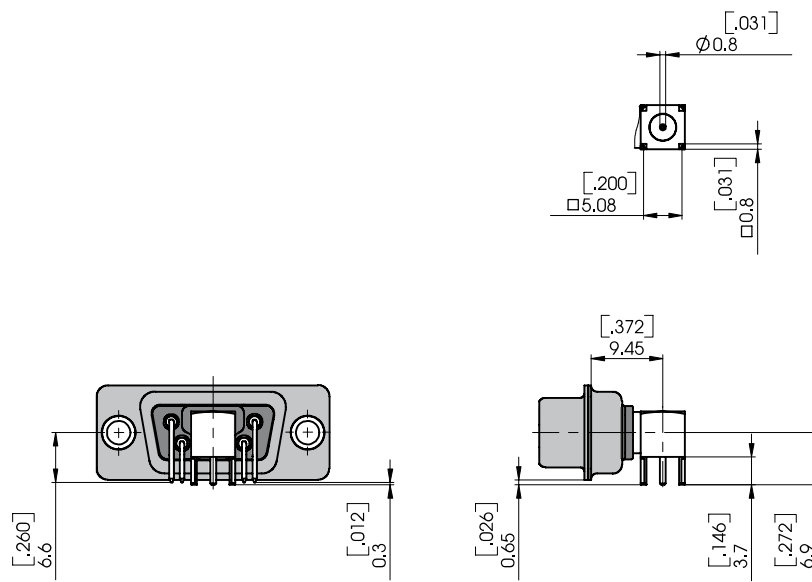

Side view without signal contacts!
Seitenansicht ohne Signalkontakte!



FME Coaxial Contacts, 75 Ohm, Straight PCB Termination, 3 Pins

FME Koaxialkontakte, 75 Ohm, gerader Leiterplattenanschluss, 3 Anschlüsse

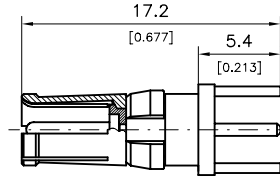
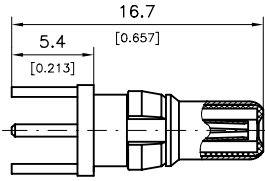

Order Number Plug <i>Bestellnummer Stecker</i>	Type <i>Ausführung</i>	Platings / <i>Oberflächen</i>				Order Number Receptacles <i>Bestellnummer Steckdose</i>
		Mating Area <i>Steckbereich</i>		Termination Area <i>Anschlussbereich</i>		
		Inner Conductor <i>Innenleiter</i>	Outer Conductor <i>Außenleiter</i>	Inner Conductor <i>Innenleiter</i>	Outer Conductor <i>Außenleiter</i>	
FME005P102	standard	1,3 μm Au	0,8 μm Au	1,3 μm Au	0,2 μm Au	FME005S102
FME005P101	low cost	0,2 μm Au	0,2 μm Au	0,2 μm Au	5 μm Sn	FME005S101
FME005P108		1,3 μm Au	0,8 μm Au	1,3 μm Au	5 μm Sn	FME005S108
FME005P202	standard	AuroPur	AuroPur	AuroPur	0,2 μm Au	FME005S202
FME005P201	low cost	AuroPur	AuroPur	AuroPur	5 μm Sn	FME005S201

Other platings on request / *Andere Oberflächen auf Anfrage*

8 microinches = $\approx 0,2 \mu\text{m}$
30 microinches = $\approx 0,8 \mu\text{m}$

50 microinches = $\approx 1,3 \mu\text{m}$
200 microinches = $\approx 5 \mu\text{m}$

Dimensions of an Example Connector with Coaxial Contacts FME005P.. and Signal Contacts P1

Abmessungen am Beispiel Steckverbinder mit Koaxialkontakt FME005P.. und Signalkontakten P1

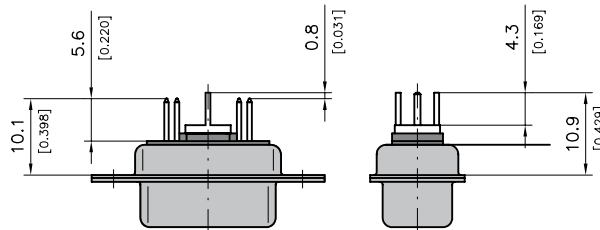

Side view without signal contacts!
Seitenansicht ohne Signalkontakte!

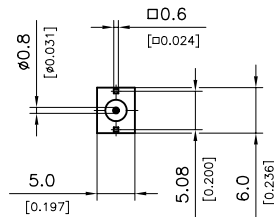



FME Coaxial Contacts, 75 Ohm, Right Angled PCB Termination, 3 Pins

FME Koaxialkontakte, 75 Ohm, abgewinkelter Leiterplattenanschluss, 3 Anschlüsse

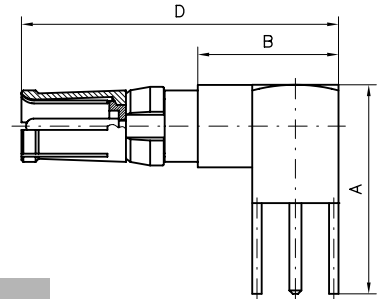
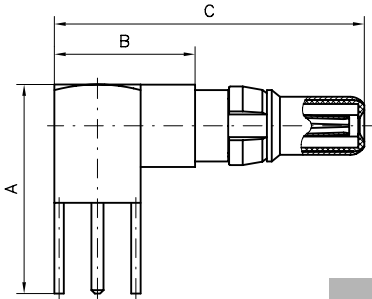

Order Number Plug <i>Bestellnummer Stecker</i>	Type <i>Ausführung</i>	Platings / <i>Oberflächen</i>				Order Number Receptacles <i>Bestellnummer Steckdose</i>
		Mating Area <i>Steckbereich</i>		Termination Area <i>Anschlussbereich</i>		
		Inner Conductor <i>Innenleiter</i>	Outer Conductor <i>Außenleiter</i>	Inner Conductor <i>Innenleiter</i>	Outer Conductor <i>Außenleiter</i>	
FME001P102	standard	1,3 μm Au	0,8 μm Au	1,3 μm Au	0,2 μm Au	FME001S102
FME001P101	low cost	0,2 μm Au	0,2 μm Au	0,2 μm Au	5 μm Sn	FME001S101
FME001P108		1,3 μm Au	0,8 μm Au	1,3 μm Au	5 μm Sn	FME001S108
FME001P202	standard	AuroPur	AuroPur	AuroPur	0,2 μm Au	FME001S202
FME001P201	low cost	AuroPur	AuroPur	AuroPur	5 μm Sn	FME001S201
FME018P102	standard	1,3 μm Au	0,8 μm Au	1,3 μm Au	0,2 μm Au	FME018S102
FME018P101	low cost	0,2 μm Au	0,2 μm Au	0,2 μm Au	5 μm Sn	FME018S101
FME018P108		1,3 μm Au	0,8 μm Au	1,3 μm Au	5 μm Sn	FME018S108

Other platings on request / *Andere Oberflächen auf Anfrage*

8 microinches = $\approx 0,2 \mu\text{m}$

30 microinches = $\approx 0,8 \mu\text{m}$

50 microinches = $\approx 1,3 \mu\text{m}$

200 microinches = $\approx 5 \mu\text{m}$

Type FME018... for use with D-Sub shell size 5 only.

Typ FME018... nur zur Verwendung in D-Sub Gehäusegröße 5.

Dimensions of an Example Connector with Coaxial Contacts FME001P... (Shell Sizes 1 - 4) or FME018P... and Signal Contacts P5

Abmessungen am Beispiel Steckverbinder mit Koaxialkontakten FME001P... (Gehäusegröße 1 - 4) oder FME018P... und Signalkontakten P5

Order Number <i>Bestellnummer</i>	A	B	C	D
FME001...	13,8 (0.543)	9,3 (0.366)	20,7 (0.815)	21,2 (0.835)
FME018...	16,8 (0.661)	11,8 (0.465)	23,2 (0.913)	23,7 (0.933)

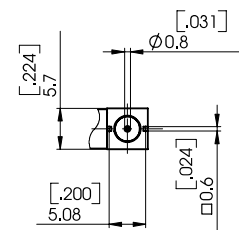

Shell sizes 1 - 4
Gehäusegrößen 1 - 4

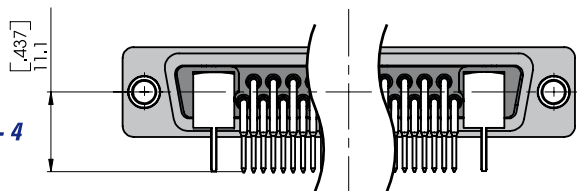

Connector with coaxial contacts FME001P... and signal contacts P5
Steckverbinder mit Koaxialkontakten FME001P... und Signalkontakten P5

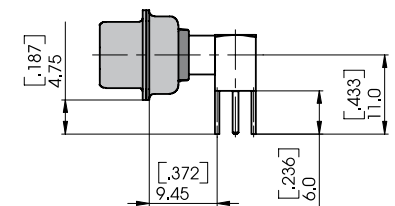

Shell size 5
Gehäusegröße 5

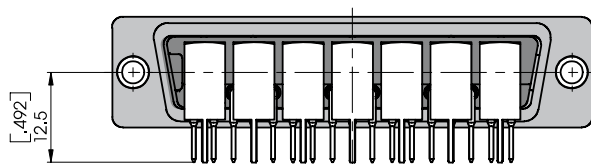

Connector with coaxial contacts FME018P... and signal contacts P5
Steckverbinder mit Koaxialkontakten FME018P... und Signalkontakten P5

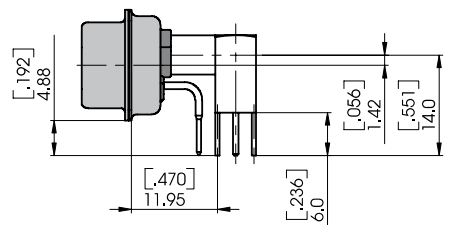



FME Coaxial Contacts, 75 Ohm, Right Angled PCB Termination, 5 Pins

FME Koaxialkontakte, 75 Ohm, abgewinkelter Leiterplattenanschluss, 5 Anschlüsse

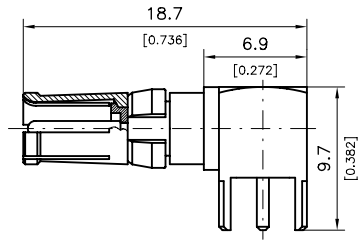
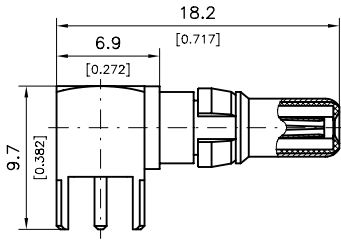

Platings / Oberflächen

Order Number Plug <i>Bestellnummer Stecker</i>	Type <i>Ausführung</i>	Mating Area <i>Steckbereich</i>		Termination Area <i>Anschlussbereich</i>		Order Number Receptacles <i>Bestellnummer Steckdose</i>
		Inner Conductor <i>Innenleiter</i>	Outer Conductor <i>Außenleiter</i>	Inner Conductor <i>Innenleiter</i>	Outer Conductor <i>Außenleiter</i>	
FME002P102	standard	1,3 μm Au	0,8 μm Au	1,3 μm Au	0,2 μm Au	FME002S102
FME002P101	low cost	0,2 μm Au	0,2 μm Au	0,2 μm Au	5 μm Sn	FME002S101
FME002P108		1,3 μm Au	0,8 μm Au	1,3 μm Au	5 μm Sn	FME002S108
FME002P202	standard	AuroPur	AuroPur	AuroPur	0,2 μm Au	FME002S202
FME002P201	low cost	AuroPur	AuroPur	AuroPur	5 μm Sn	FME002S201

Other platings on request / *Andere Oberflächen auf Anfrage*

8 microinches = $\approx 0,2 \mu\text{m}$
30 microinches = $\approx 0,8 \mu\text{m}$

50 microinches = $\approx 1,3 \mu\text{m}$
200 microinches = $\approx 5 \mu\text{m}$

Dimensions of an Example Connector with Coaxial Contact FME002P... and Signal Contacts P45

Abmessungen am Beispiel Steckverbinder mit Koaxialkontakt FME002P... und Signalkontakten P45

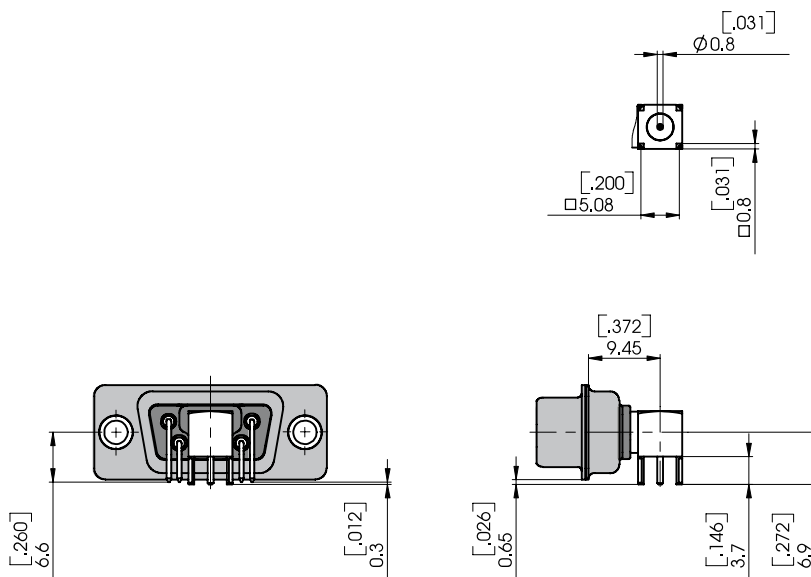

Side view without signal contacts!
Seitenansicht ohne Signalkontakte!

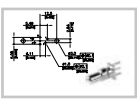

PCB Hole Pattern for Connectors with Straight PCB Terminations

Leiterplattenlochbild für Steckverbinder mit geradem Leiterplattenanschluss

All PCB hole patterns apply to male connectors with straight PCB contacts (signal contacts P1) and the coaxial contacts **FME010P...** or **FME005P...** (when using female connectors the hole pattern must be mirrored on the Y-axis).

Measurements without tolerances are in accordance with DIN ISO 2768 m.

Alle Lochbilder gelten für Stiftsteckverbinder mit geradem Leiterplattenanschluss (Signalkontakte P1) und eingebauten Koaxialkontakten **FME010P...** bzw. **FME005P...** (bei Verwendung von Buchsensteckverbindern muss das Lochbild an der Y-Achse gespiegelt werden).

Maße ohne Toleranzangabe nach DIN ISO 2768 m.

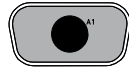

F1W1

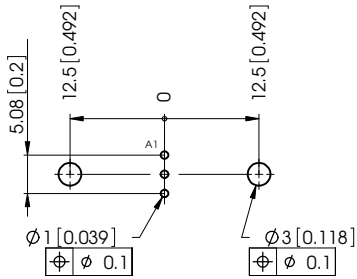

F2W2...C / FM2W2

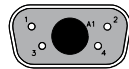
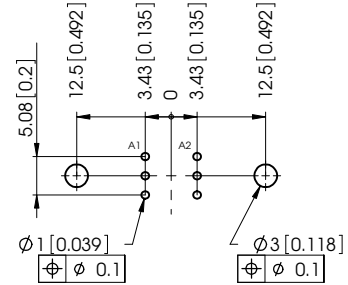

FM5W1

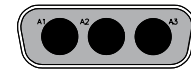
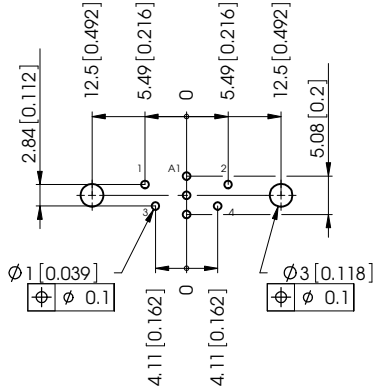

FM3W3 / F3W3...C

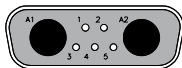
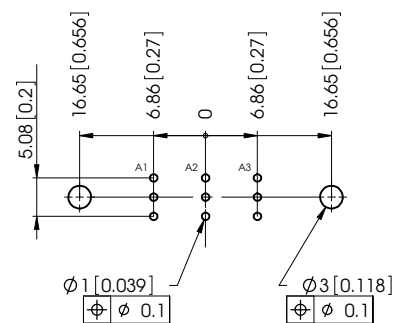

FM7W2

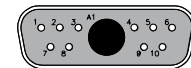
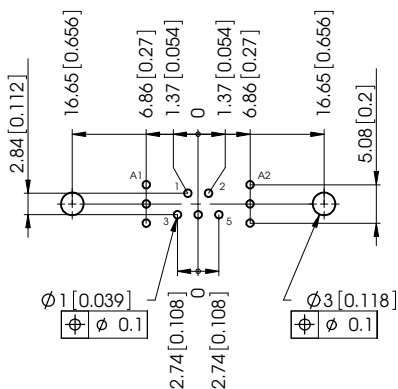

FM11W1

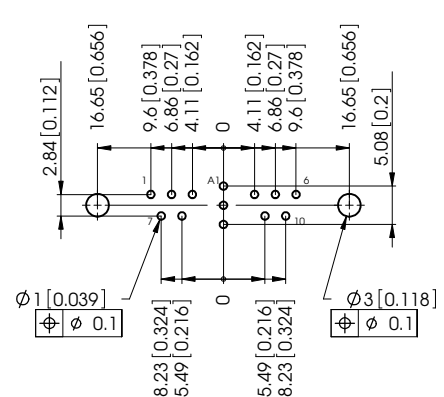

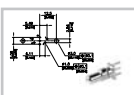

PCB Hole Pattern for Connectors with Straight PCB Terminations

Leiterplattenlochbild für Steckverbinder mit geradem Leiterplattenanschluss

All PCB hole patterns apply to male connectors with straight PCB contacts (signal contacts P1) and the coaxial contacts **FME010P...** or **FME005P...** (when using female connectors the hole pattern must be mirrored on the Y-axis).

Measurements without tolerances are in accordance with DIN ISO 2768 m.

*Alle Lochbilder gelten für Stiftsteckverbinder mit geradem Leiterplattenanschluss (Signalkontakte P1) und eingebauten Koaxialkontakten **FME010P...** bzw. **FME005P...** (bei Verwendung von Buchsensteckverbindern muss das Lochbild an der Y-Achse gespiegelt werden).*

Maße ohne Toleranzangabe nach DIN ISO 2768 m.

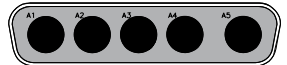

FM5W5

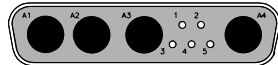
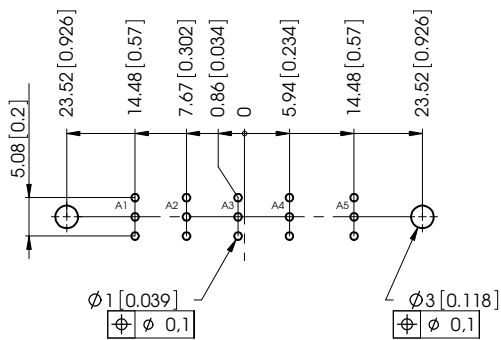

FM9W4

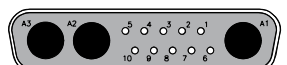
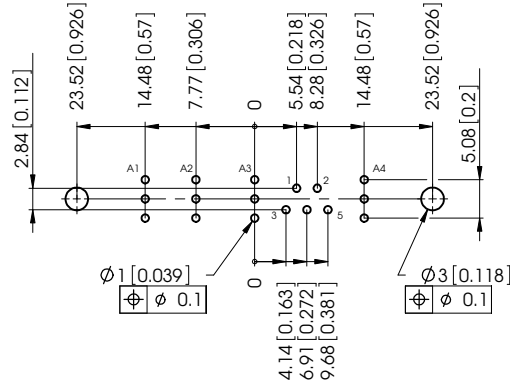

FM13W3

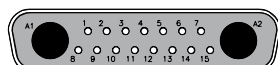
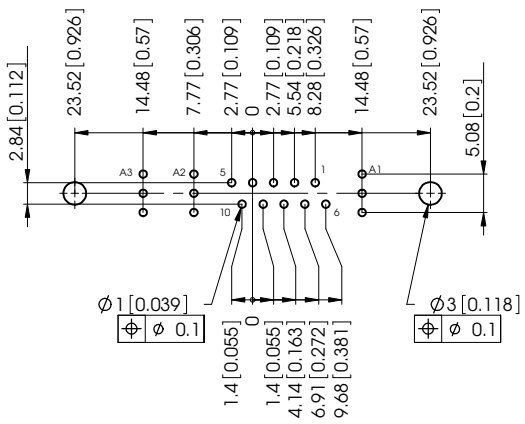

FM17W2

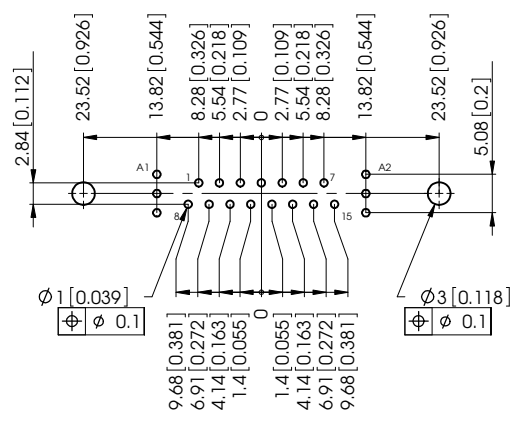

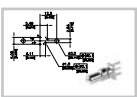

PCB Hole Pattern for Connectors with Straight PCB Terminations

Leiterplattenlochbild für Steckverbinder mit geradem Leiterplattenanschluss

All PCB hole patterns apply to male connectors with straight PCB contacts (signal contacts P1) and the coaxial contacts **FME010P...** or **FME005P...** (when using female connectors the hole pattern must be mirrored on the Y-axis).

Measurements without tolerances are in accordance with DIN ISO 2768 m.

Alle Lochbilder gelten für Stiftsteckverbinder mit geradem Leiterplattenanschluss (Signalkontakte P1) und eingebauten Koaxialkontakten **FME010P...** bzw. **FME005P...** (bei Verwendung von Buchsensteckverbindern muss das Lochbild an der Y-Achse gespiegelt werden).

Maße ohne Toleranzangabe nach DIN ISO 2768 m.

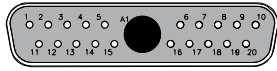

FM21W1

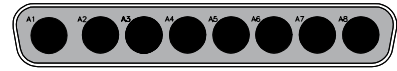
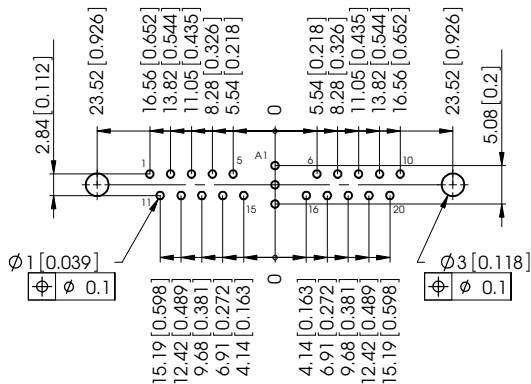

FM8W8

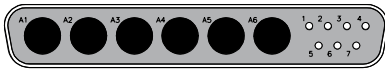
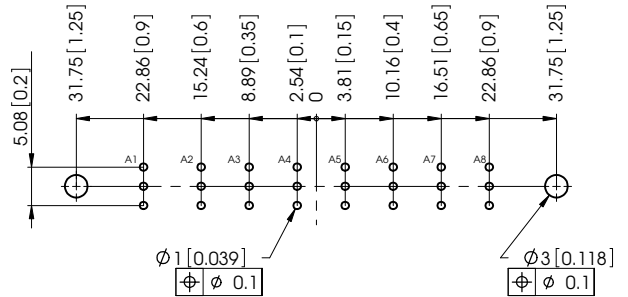

FM13W6

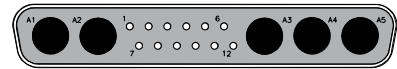
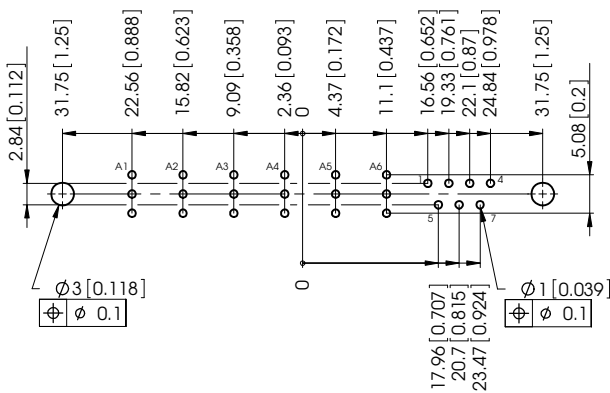

FM17W5

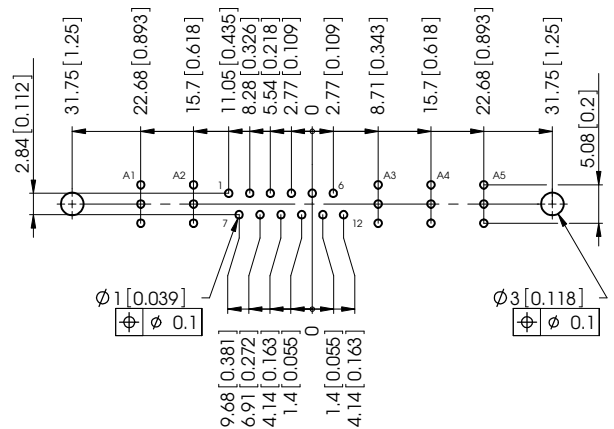

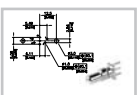

PCB Hole Pattern for Connectors with Straight PCB Terminations

Leiterplattenlochbild für Steckverbinder mit geradem Leiterplattenanschluss

All PCB hole patterns apply to male connectors with straight PCB contacts (signal contacts P1) and the coaxial contacts **FME010P...** or **FME005P...** (when using female connectors the hole pattern must be mirrored on the Y-axis).

Measurements without tolerances are in accordance with DIN ISO 2768 m.

Alle Lochbilder gelten für Stiftsteckverbinder mit geradem Leiterplattenanschluss (Signalkontakte P1) und eingebauten Koaxialkontakten **FME010P...** bzw. **FME005P...** (bei Verwendung von Buchsensteckverbindern muss das Lochbild an der Y-Achse gespiegelt werden).

Maße ohne Toleranzangabe nach DIN ISO 2768 m.

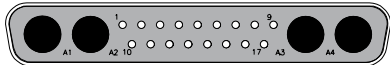

FM21WA4

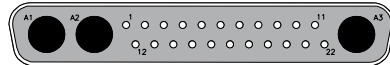
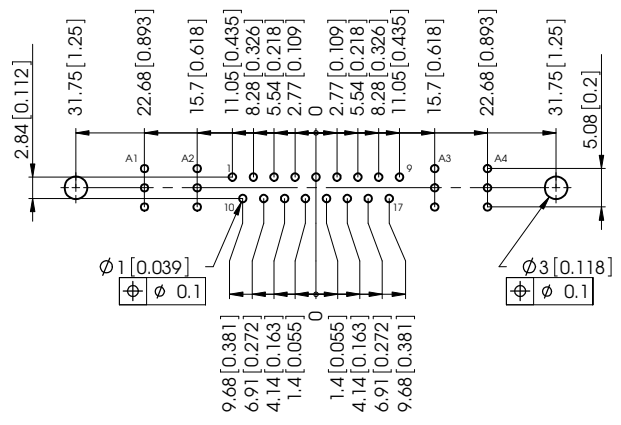

FM25W3

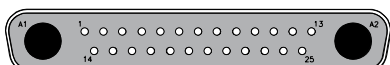
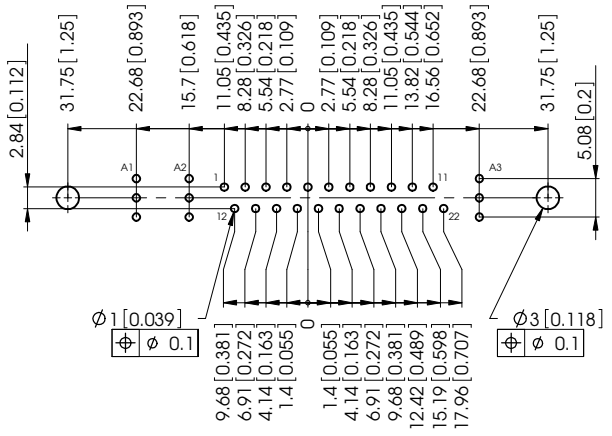

FM27W2

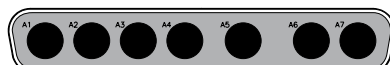
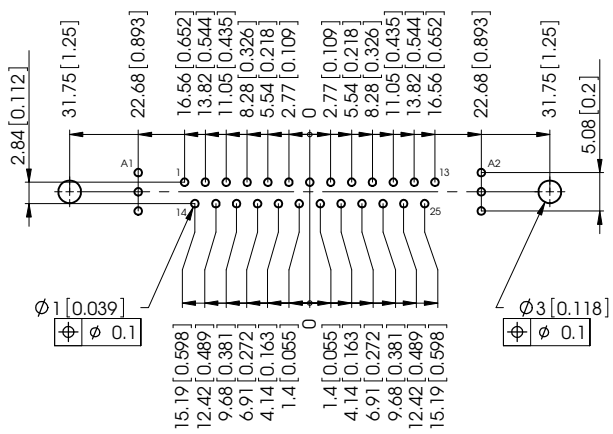

F7W7

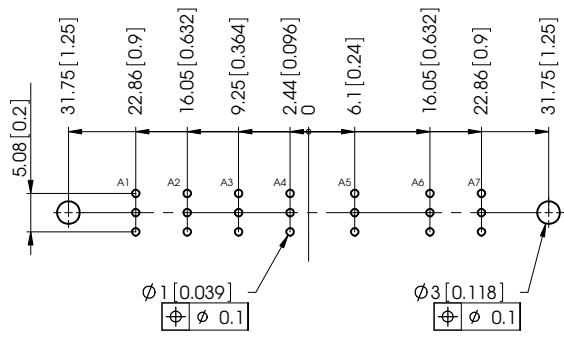

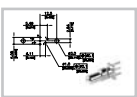

PCB Hole Pattern for Connectors with Straight PCB Terminations

Leiterplattenlochbild für Steckverbinder mit geradem Leiterplattenanschluss

All PCB hole patterns apply to male connectors with straight PCB contacts (signal contacts P1) and the coaxial contacts **FME010P...** or **FME005P...** (when using female connectors the hole pattern must be mirrored on the Y-axis).

Measurements without tolerances are in accordance with DIN ISO 2768 m.

Alle Lochbilder gelten für Stiftsteckverbinder mit geradem Leiterplattenanschluss (Signalkontakte P1) und eingebauten Koaxialkontakten **FME010P...** bzw. **FME005P...** (bei Verwendung von Buchsensteckverbindern muss das Lochbild an der Y-Achse gespiegelt werden).

Maße ohne Toleranzangabe nach DIN ISO 2768 m.

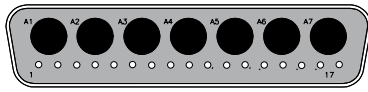

FM24W4

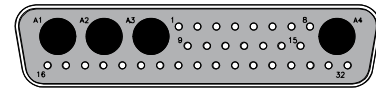
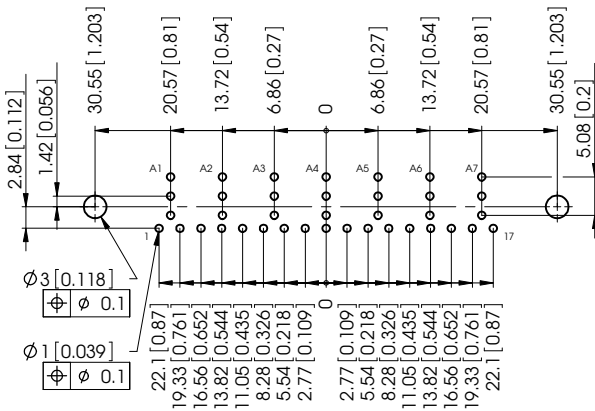

FM36W4

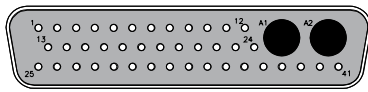
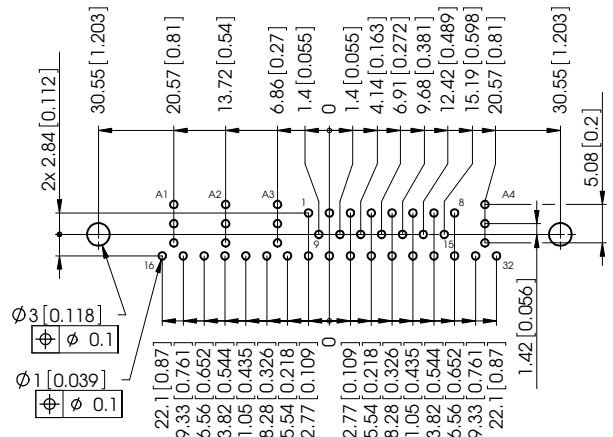

FM43W2

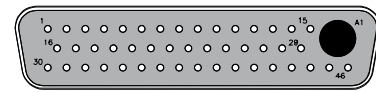
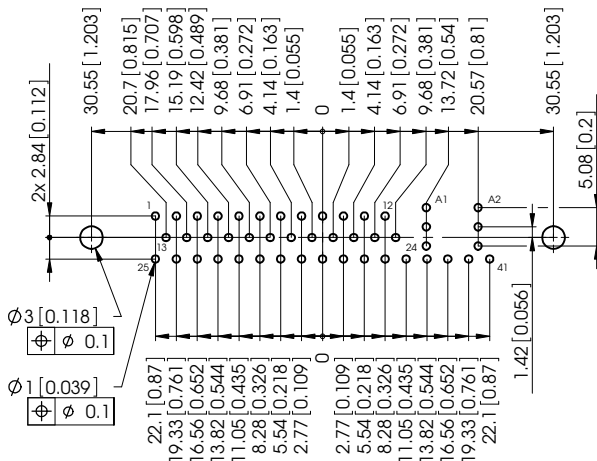

FM47W1

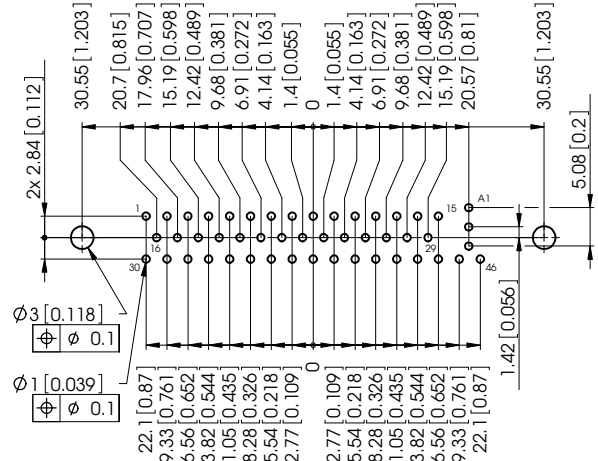

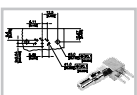

PCB Hole Pattern for Connectors with Right Angled PCB Terminations

Leiterplattenlochbild für Steckverbinder mit abgewinkelttem Leiterplattenanschluss

All PCB hole patterns apply to male connectors with right angle PCB contacts (signal contacts P5) and the metal bracket F1080-13B as well as the coaxial contacts **FME008P...** or **FME001P...** (When using female connectors the hole pattern must be mirrored on the Y-axis).

Measurements without tolerances are in accordance with DIN ISO 2768 m.

Alle Lochbilder gelten für Stiftsteckverbinder mit abgewinkelttem Leiterplattenanschluss (Signalkontakte P5) und Metallwinkel F1080-13B sowie eingebauten Koaxialkontakten **FME008P...** bzw. **FME001P...** (bei Verwendung von Buchsensteckverbindern muss das Lochbild an der Y-Achse gespiegelt werden).

Maße ohne Toleranzangabe nach DIN ISO 2768 m.

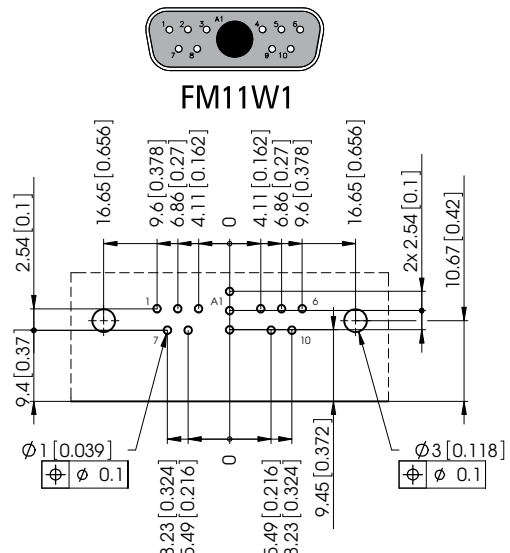
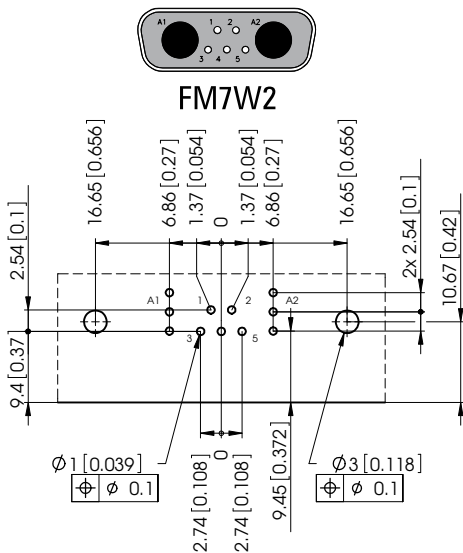
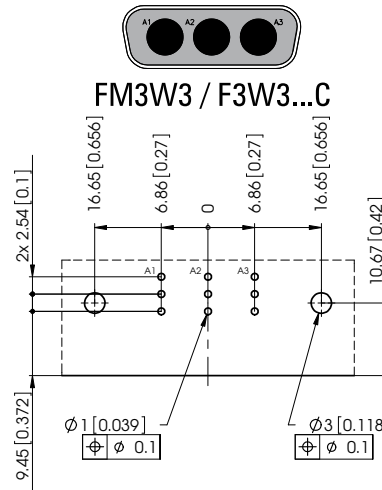
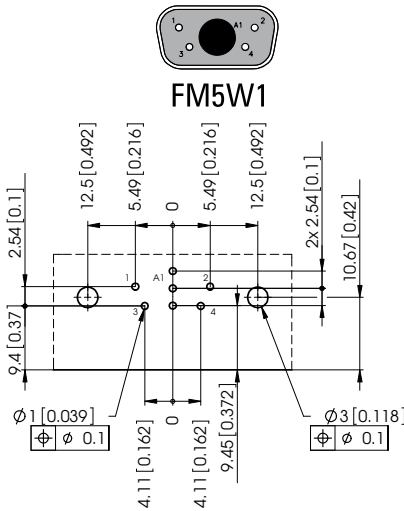
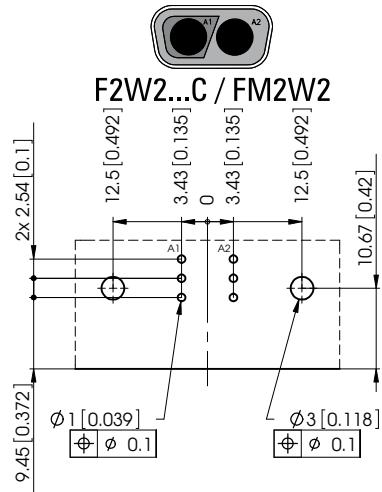
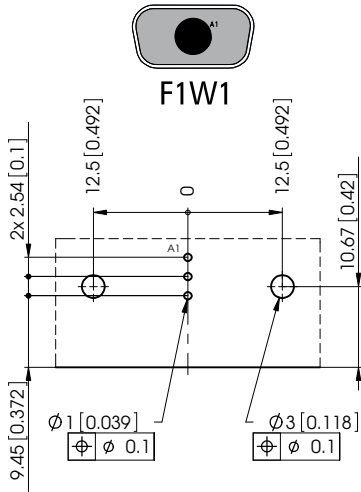

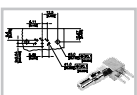

PCB Hole Pattern for Connectors with Right Angled PCB Terminations

Leiterplattenlochbild für Steckverbinder mit abgewinkelttem Leiterplattenanschluss

All PCB hole patterns apply to male connectors with right angle PCB contacts (signal contacts P5) and the metal bracket F1080-13B as well as the coaxial contacts **FME008P...** or **FME001P...** (When using female connectors the hole pattern must be mirrored on the Y-axis).

Measurements without tolerances are in accordance with DIN ISO 2768 m.

Alle Lochbilder gelten für Stiftsteckverbinder mit abgewinkelttem Leiterplattenanschluss (Signalkontakte P5) und Metallwinkel F1080-13B sowie eingebauten Koaxialkontakten **FME008P...** bzw. **FME001P...** (bei Verwendung von Buchsensteckverbindern muss das Lochbild an der Y-Achse gespiegelt werden).

Maße ohne Toleranzangabe nach DIN ISO 2768 m.

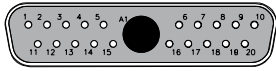

FM21W1

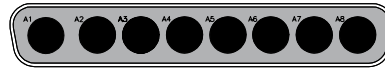
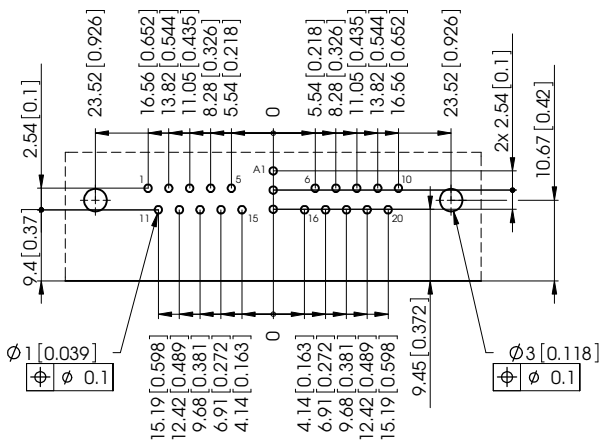

FM8W8

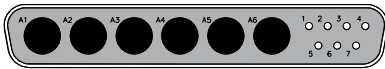
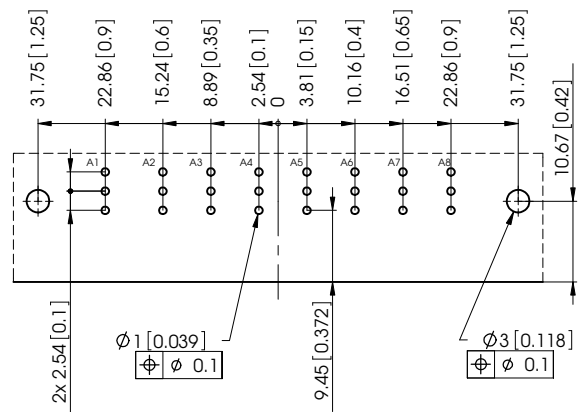

FM13W6

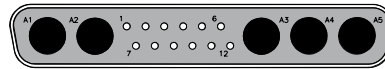
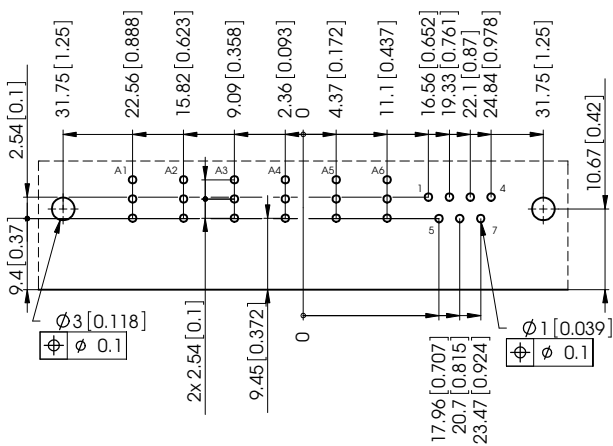

FM17W5

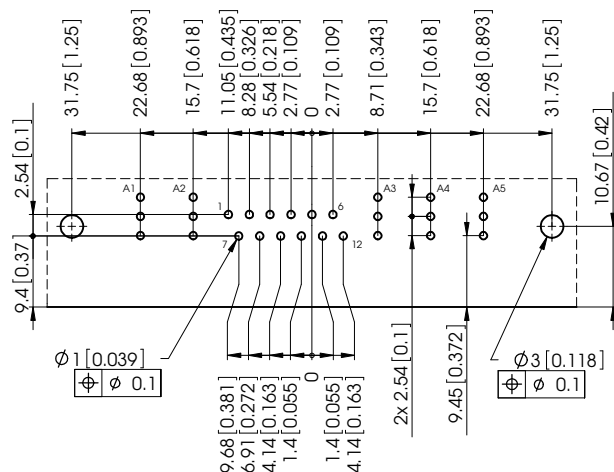

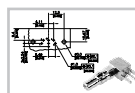

PCB Hole Pattern for Connectors with Right Angled PCB Terminations

Leiterplattenlochbild für Steckverbinder mit abgewinkelttem Leiterplattenanschluss

All PCB hole patterns apply to male connectors with right angle PCB contacts (signal contacts P5) and the metal bracket F1080-13B as well as the coaxial contacts **FME008P..** or **FME001P..** (When using female connectors the hole pattern must be mirrored on the Y-axis). 

Measurements without tolerances are in accordance with DIN ISO 2768 m.

Alle Lochbilder gelten für Stiftsteckverbinder mit abgewinkelttem Leiterplattenanschluss (Signalkontakte P5) und Metallwinkel F1080-13B sowie eingebauten Koaxialkontakten **FME008P..** bzw. **FME001P..** (bei Verwendung von Buchsensteckverbindern muss das Lochbild an der Y-Achse gespiegelt werden).

Maße ohne Toleranzangabe nach DIN ISO 2768 m.

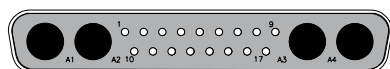

FM21WA4

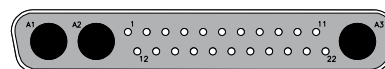
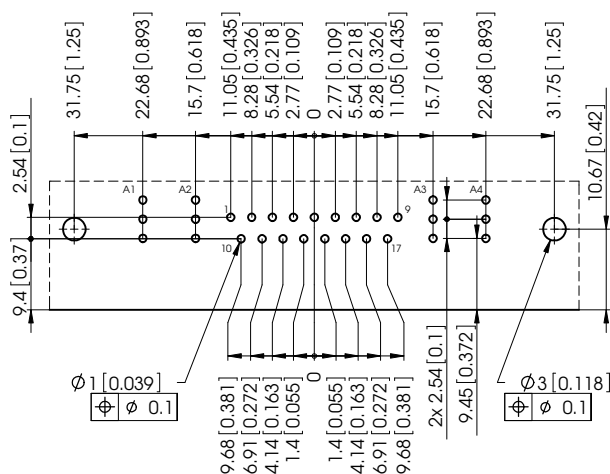

FM25W3

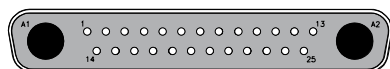
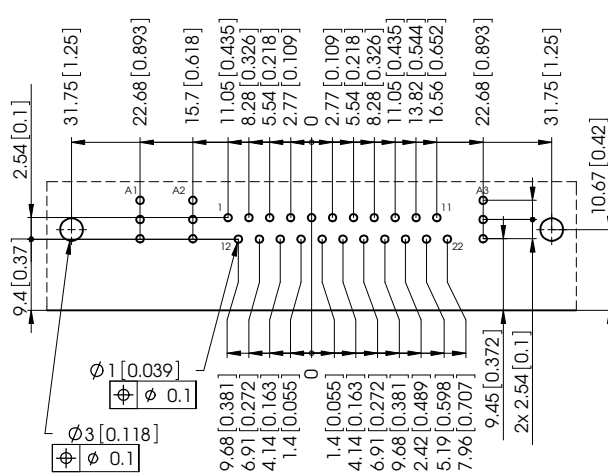

FM27W2

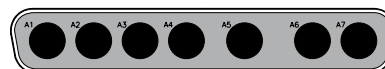
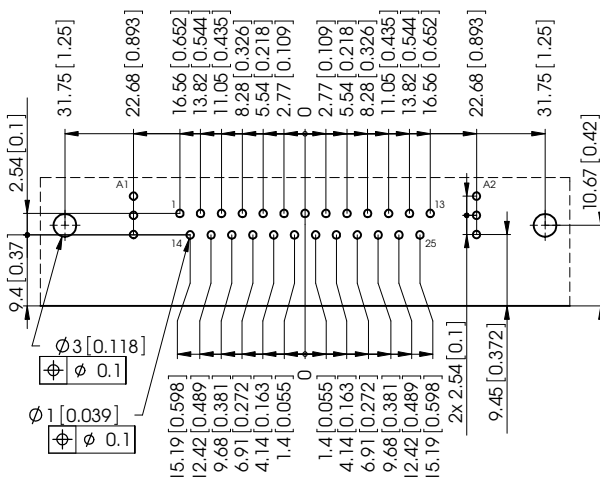

F7W7

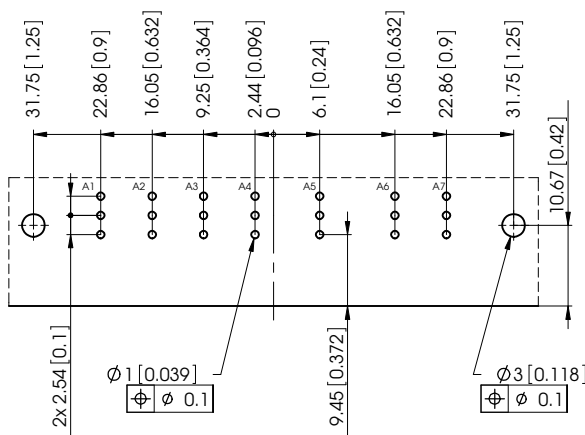

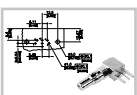

PCB Hole Pattern for Connectors with Right Angled PCB Terminations

Leiterplattenlochbild für Steckverbinder mit abgewinkeltm Leiterplattenanschluss

All PCB hole patterns apply to male connectors with right angle PCB contacts (signal contacts P5) and the metal bracket F1080-23 as well as the coaxial contacts FME018P... or FME020P... (When using female connectors the hole pattern must be mirrored on the Y-axis).

Measurements without tolerances are in accordance with DIN ISO 2768 m. Alle Lochbilder gelten für Stiftsteckverbinder mit abgewinkeltm Leiterplattenanschluss (Signalkontakte P5) und Metallwinkel F1080-23 sowie eingebauten Koaxialkontakten FME018P... bzw. FME020P... (bei Verwendung von Buchsensteckverbindern muss das Lochbild an der Y-Achse gespiegelt werden).

Maße ohne Toleranzangabe nach DIN ISO 2768 m.

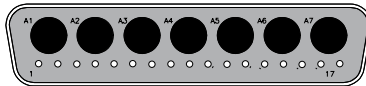

FM24W7

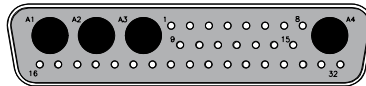

FM36W4

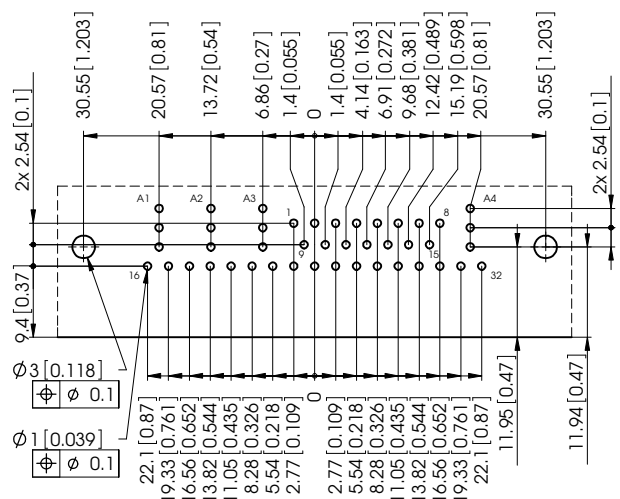
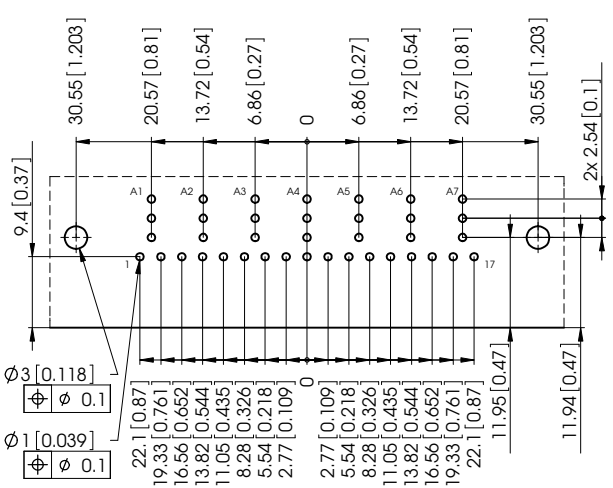

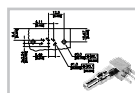

PCB Hole Pattern for Connectors with Right Angled PCB Terminations

Leiterplattenlochbild für Steckverbinder mit abgewinkelttem Leiterplattenanschluss

All PCB hole patterns apply to male connectors with right angle PCB contacts (signal contacts P5) and the metal bracket F1080-23 as well as the coaxial contacts **FME018P...** or **FME020P...** (When using female connectors the hole pattern must be mirrored on the Y-axis). 
 Measurements without tolerances are in accordance with DIN ISO 2768 m.

Alle Lochbilder gelten für Stiftsteckverbinder mit abgewinkelttem Leiterplattenanschluss (Signalkontakte P5) und Metallwinkel F1080-23 sowie eingebauten Koaxialkontakten **FME018P...** bzw. **FME020P...** (bei Verwendung von Buchsensteckverbindern muss das Lochbild an der Y-Achse gespiegelt werden). 
 Maße ohne Toleranzangabe nach DIN ISO 2768 m.

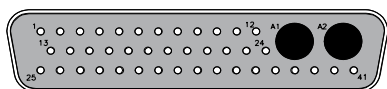

FM43W2

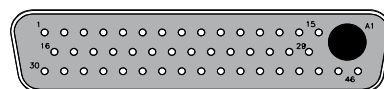
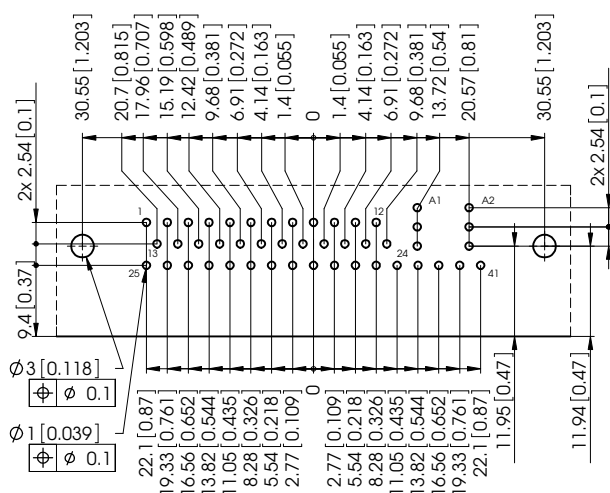

FM47W1

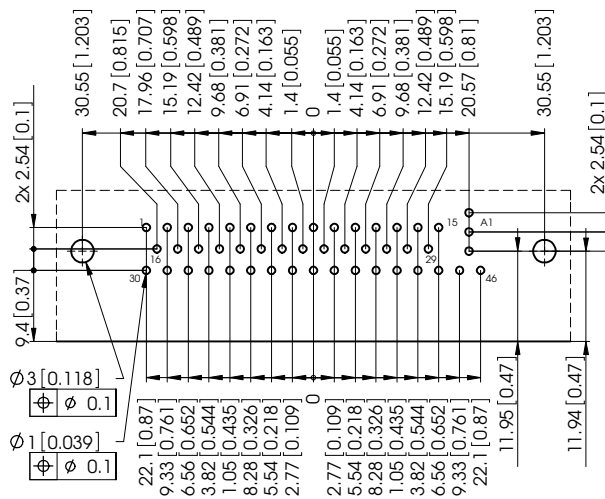



FBM Coaxial Contacts, Mating Area Dimensions

FBM Koaxialkontakte, Abmessungen Steckbereich

Plug

Stecker

Socket

Buchse

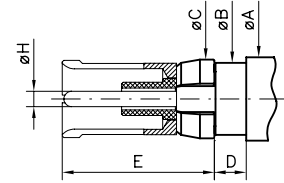
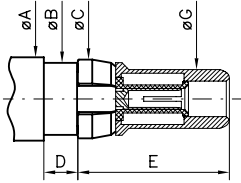

	Plug / <i>Stecker</i>		Socket / <i>Buchse</i>	
	min	max.	min Modi. U*	max. Modi. U*
ØA	—	5,60 (0.220)	—	5,60 (0.220)
ØB	4,75 (0.187)	4,80 (0.189)	4,75 (0.187)	4,80 (0.189)
ØC	5,00 (0.197)	5,40 (0.213)	5,00 (0.197)	5,40 (0.213)
D	2,25 (0.089)	2,45 (0.096)	2,10 (0.083)	2,25 (0.089)
E	—	10,00 (0.394)	—	10,10 (0.398)
ØF	—	2,35 (0.093)	—	—
ØG	3,88 (0.153)	3,92 (0.154)	—	—
ØH	—	—	1,00 (0.039)	1,04 (0.041)

Modification U* please see page 26

Modifikation U siehe Seite 26*



Hole patterns for FBM coaxial contacts please refer to pages 47 onwards.
Lochbilder für FBM Koaxialkontakte siehe ab Seite 47 ff.



FBM Coaxial Contacts, 50 Ohm, Straight Cable Termination

FBM Koaxialkontakte, 50 Ohm, gerader Kabelanschluss

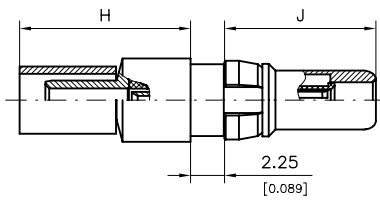

Inner Conductor <i>Innenleiter</i>	Outer Conductor <i>Außenleiter</i>
—	Crimp termination <i>Crimpen</i>
Solder termination <i>Löten</i>	Solder termination <i>Löten</i>

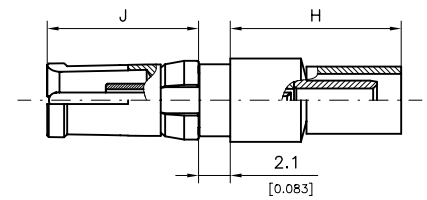

Order Number Plug <i>Bestellnummer Stecker</i>	Type <i>Ausführung</i>	Platings / <i>Oberflächen</i>				Suitable Cables RG- <i>Verwendbare Kabel RG-</i>	Order Number Receptacles <i>Bestellnummer Steckdose</i>
		Mating Area <i>Steckbereich</i>		Termination Area <i>Anschlussbereich</i>			
		Inner Conductor <i>Innenleiter</i>	Outer Conductor <i>Außenleiter</i>	Inner Conductor <i>Innenleiter</i>	Outer Conductor <i>Außenleiter</i>		
FBM002P154M	CuBe	1,3 μm Au	0,8 μm Au	1,3 μm Au	0,2 μm Au	316, double braided <i>doppelt geschirmt</i>	FBM002S154U
FBM003P154M	CuBe	1,3 μm Au	1,3 μm Au	1,3 μm Au	0,2 μm Au	316	FBM003S154U

Other platings on request / *Andere Oberflächen auf Anfrage*
Tools from page 94 onwards / *Werkzeuge ab Seite 94 ff.*

8 microinches = $\approx 0,2 \mu\text{m}$
30 microinches = $\approx 0,8 \mu\text{m}$

50 microinches = $\approx 1,3 \mu\text{m}$
200 microinches = $\approx 5 \mu\text{m}$

Dimensions

Abmessungen

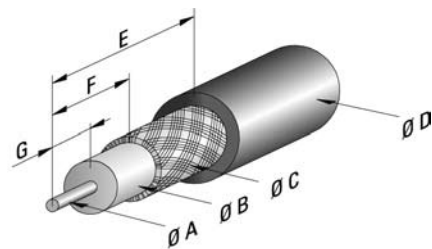
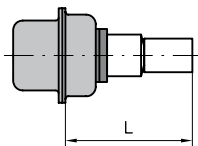

Order Number <i>Bestellnummer</i>	Ø A max.	Ø B max.	Ø C max.	Ø D max.	E	F	G	H	J	L
FBM002P...	0,55 (0.022)	1,55 (0.061)	2,5 (0.098)	3,5 (0.138)	9,5 (0.374)	5,0 (0.197)	3,0 (0.118)	11,3 (0.445)	10,0 (0.394)	16,7 (0.657)
FBM002S...	0,55 (0.022)	1,55 (0.061)	2,5 (0.098)	3,5 (0.138)	9,5 (0.374)	5,0 (0.197)	3,0 (0.118)	11,5 (0.453)	10,1 (0.398)	16,9 (0.665)
FBM003P...	0,55 (0.022)	1,55 (0.061)	2,2 (0.087)	3,2 (0.126)	9,5 (0.374)	5,0 (0.197)	3,0 (0.118)	11,3 (0.445)	10,0 (0.394)	16,7 (0.657)
FBM003S...	0,55 (0.022)	1,55 (0.061)	2,2 (0.087)	3,2 (0.126)	9,5 (0.374)	5,0 (0.197)	3,0 (0.118)	11,5 (0.453)	10,1 (0.398)	16,9 (0.665)



FBM Coaxial Contacts, 50 Ohm, Straight Semi Rigid Cable Termination

FBM Koaxialkontakte, 50 Ohm, gerader semi rigid Kabelanschluss

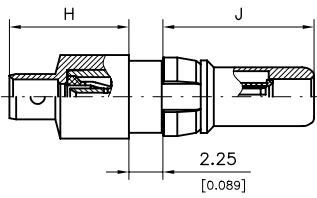

Inner Conductor <i>Innenleiter</i>	Outer Conductor <i>Außenleiter</i>
Crimp termination <i>Crimpen</i>	—
Solder termination <i>Löten</i>	Solder termination <i>Löten</i>

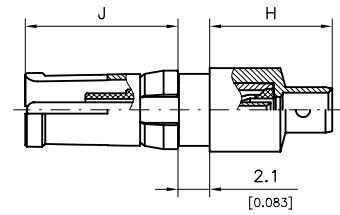

Order Number Plug <i>Bestellnummer Stecker</i>	Type <i>Ausführung</i>	Platings / <i>Oberflächen</i>				Suitable Cables <i>Verwendbare Kabel</i>	Order Number Receptacles <i>Bestellnummer Steckdose</i>
		Mating Area <i>Steckbereich</i>		Termination Area <i>Anschlussbereich</i>			
		Inner Conductor <i>Innenleiter</i>	Outer Conductor <i>Außenleiter</i>	Inner Conductor <i>Innenleiter</i>	Outer Conductor <i>Außenleiter</i>		
FBM004P154M	CuBe	1,3 μm Au	0,8 μm Au	1,3 μm Au	0,2 μm Au	T-Flex 405, Semi rigid 0.086	FBM004S154U
FBM005P154M	CuBe	1,3 μm Au	0,8 μm Au	1,3 μm Au	0,2 μm Au	T-Flex 402, Semi rigid 0.141	FBM005S154U

Other platings on request / *Andere Oberflächen auf Anfrage*
Tools from page 9 onwards / *Werkzeuge ab Seite 94 ff.*

8 microinches = $\approx 0,2 \mu\text{m}$
30 microinches = $\approx 0,8 \mu\text{m}$

50 microinches = $\approx 1,3 \mu\text{m}$
200 microinches = $\approx 5 \mu\text{m}$

Dimensions

Abmessungen

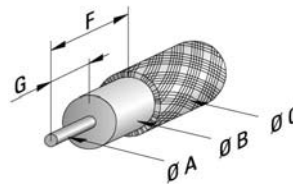
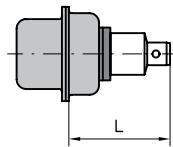

Order Number <i>Bestellnummer</i>	Ø A max.	Ø B max.	Ø C max.	Ø D max.	F	G	H	J	L
FBM004P...	0,55 (0.022)	1,7 (0.067)	2,3 (0.091)	—	3,7 (0.146)	3,1 (0.122)	7,9 (0.311)	10,0 (0.394)	13,3 (0.524)
FBM004S...	0,55 (0.022)	1,7 (0.067)	2,3 (0.091)	—	3,7 (0.146)	3,1 (0.122)	8,1 (0.319)	10,1 (0.398)	13,5 (0.531)
FBM005P...	0,97 (0.038)	—	3,7 (0.146)	—	2,3 (0.091)	2,3 (0.091)	10,6 (0.417)	10,0 (0.394)	16,0 (0.630)
FBM005S...	0,97 (0.038)	—	3,7 (0.146)	—	2,3 (0.091)	2,3 (0.091)	10,8 (0.425)	10,1 (0.398)	16,2 (0.638)



FBM Coaxial Contacts, 50 Ohm, Straight PCB Termination, 3 Pins

FBM Koaxialkontakte, 50 Ohm, gerader Leiterplattenanschluss, 3 Anschlüsse

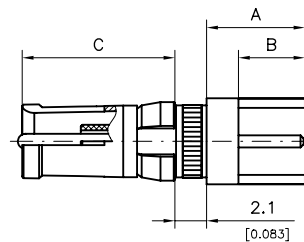
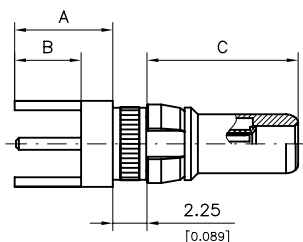

Order Number Plug <i>Bestellnummer Stecker</i>	Type <i>Ausführung</i>	Platings / <i>Oberflächen</i>				Order Number Receptacles <i>Bestellnummer Steckdose</i>
		Mating Area <i>Steckbereich</i>		Termination Area <i>Anschlussbereich</i>		
		Inner Conductor <i>Innenleiter</i>	Outer Conductor <i>Außenleiter</i>	Inner Conductor <i>Innenleiter</i>	Outer Conductor <i>Außenleiter</i>	
FBM006P154MR	CuBe	1,3 μm Au	0,8 μm Au	1,3 μm Au	0,2 μm Au	FBM006S154UR
Other platings on request / <i>Andere Oberflächen auf Anfrage</i>				8 microinches = ≈0,2 μm 30 microinches = ≈0,8 μm		50 microinches = ≈1,3 μm 200 microinches = ≈5 μm

Dimensions of an Example Connector with Coaxial Contact FBM006P.. and Signal Contacts P22

Abmessungen am Beispiel Steckverbinder mit Koaxialkontakt FBM006P..... und Signalkontakten P22

Order Number <i>Bestellnummer</i>	A	B	C
FBM006P...M	6,5 (0.256)	4,4 (0.173)	10,0 (0.394)
FBM006S...U	6,7 (0.264)	4,4 (0.173)	10,1 (0.398)

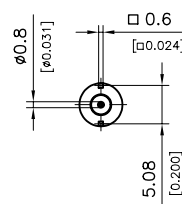
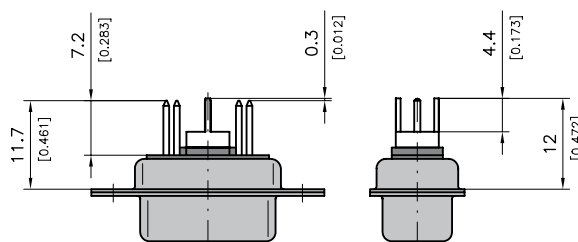

Side view without signal contacts!
Seitenansicht ohne Signalkontakte!



FBM Coaxial Contacts, 50 Ohm, Straight PCB Termination, 5 Pins

FBM Koaxialkontakte, 50 Ohm, gerader Leiterplattenanschluss, 5 Anschlüsse

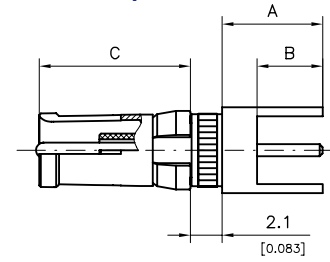
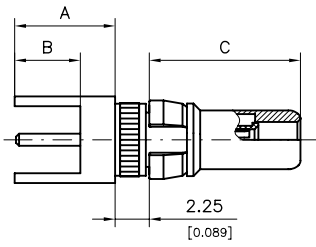

Order Number Plug <i>Bestellnummer Stecker</i>	Type <i>Ausführung</i>	Platings / <i>Oberflächen</i>				Order Number Receptacles <i>Bestellnummer Steckdose</i>
		Mating Area <i>Steckbereich</i>		Termination Area <i>Anschlussbereich</i>		
		Inner Conductor <i>Innenleiter</i>	Outer Conductor <i>Außenleiter</i>	Inner Conductor <i>Innenleiter</i>	Outer Conductor <i>Außenleiter</i>	
FBM007P154MR	CuBe	1,3 µm Au	0,8 µm Au	1,3 µm Au	0,2 µm Au	FBM007S154UR
		Other platings on request / <i>Andere Oberflächen auf Anfrage</i>		8 microinches = ≈ 0,2 µm	50 microinches = ≈ 1,3 µm	
				30 microinches = ≈ 0,8 µm	200 microinches = ≈ 5 µm	

Dimensions of an Example Connector with Coaxial Contact FBM007P... and Signal Contacts P22

Abmessungen am Beispiel Steckverbinder mit Koaxialkontakt FBM007P... und Signalkontakten P22

Order Number <i>Bestellnummer</i>	A	B	C
FBM007P...M	6,5 (0.256)	4,4 (0.173)	10,0 (0.394)
FBM007S...U	6,7 (0.264)	4,4 (0.173)	10,1 (0.398)

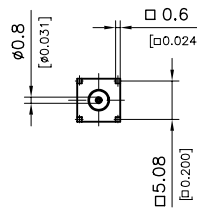
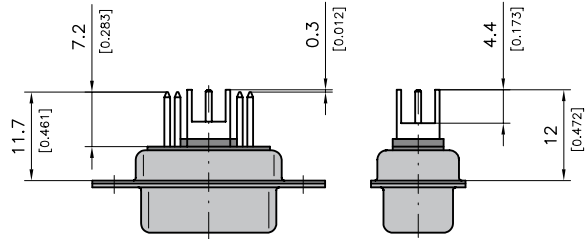

Side view without signal contacts!
Seitenansicht ohne Signalkontakte!



FBM Coaxial Contacts, 50 Ohm, Right Angled PCB Termination, 3 Pins

FBM Koaxialkontakte, 50 Ohm, abgewinkelter Leiterplattenanschluss, 3 Anschlüsse

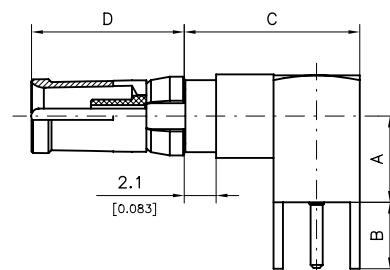
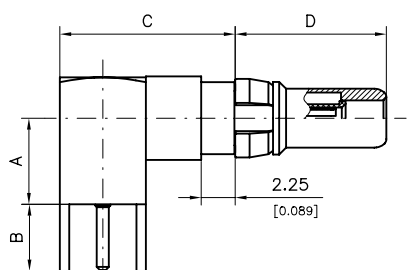

		Platings / Oberflächen				
		Mating Area Steckbereich		Termination Area Anschlussbereich		
Order Number Plug Bestellnummer Stecker	Type Ausführung	Inner Conductor Innenleiter	Outer Conductor Außenleiter	Inner Conductor Innenleiter	Outer Conductor Außenleiter	Order Number Receptacles Bestellnummer Steckdose
FBM001P154MR	CuBe	1,3 μm Au	0,8 μm Au	1,3 μm Au	0,2 μm Au	FBM001S154UR
Other platings on request / Andere Oberflächen auf Anfrage				8 microinches = ≈0,2 μm		50 microinches = ≈1,3 μm
				30 microinches = ≈0,8 μm		200 microinches = ≈5 μm

Dimensions of an Example Connector with Coaxial Contacts FBM001P... and Signal Contacts P5

Abmessungen am Beispiel Steckverbinder mit Koaxialkontakten FBM001P... und Signalkontakten P5

Order Number Bestellnummer	A	B	C	D
FBM001P...M	5,7 (0.224)	4,4 (0.173)	11,6 (0.457)	10,0 (0.394)
FBM001S...U	5,7 (0.224)	4,4 (0.173)	11,6 (0.457)	10,1 (0.398)

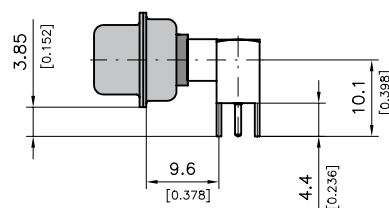
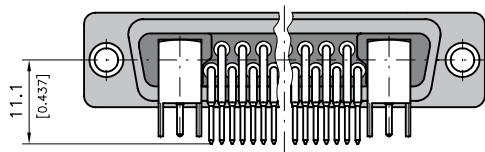
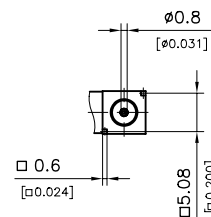

Side view without signal contacts!
Seitenansicht ohne Signalkontakte!



High Power Contacts

Hochstromkontakte

Technical Data

Technische Daten

Mechanical Data

Mechanische Daten

Mechanical Data <i>Mechanische Daten</i>	
Mating force (pair of contacts) <i>Steckkraft (Kontaktpaar)</i>	≤ 7 N
Unmating force <i>Ziehkraft</i>	ca. 5 N
Temperature range (test category 55/155/21 to DIN, IEC 68 part 1) <i>Temperaturbereich (Prüfklasse 55/155/21 nach DIN, IEC 68 Teil 1)</i>	-55 °C bis 155 °C (-67 °F to 311 °F)
Mating cycles (standard) <i>Steckzyklen (Standard)</i>	≥ 500
Mating cycles (low cost) <i>Steckzyklen (Low cost)</i>	≥ 200

Electrical Data

Elektrische Daten

Electrical Data <i>Elektrische Daten</i>	
Contact resistance <i>Durchgangswiderstand</i>	≤ 1 mΩ
Current rating (DC with an ambient temperature of 20°C) (see from page 66 onwards) <i>Maximaler Kontaktstrom (DC bei 20°C Umgebungstemperatur) (siehe Seite 66 ff.)</i>	10 - 40 A

Materials

Materialien

Materials <i>Materialien</i>	
Pin contact <i>Stiftkontakt</i>	Cu alloy <i>Cu Legierung</i>
Socket contact <i>Buchsenkontakt</i>	Cu alloy <i>Cu Legierung</i>
Retaining clip <i>Halteclip</i>	Cu alloy <i>Cu Legierung</i>



High Power Contacts, Mating Area Dimensions

Hochstromkontakte, Abmessungen Steckbereich

Plug

Stecker

Socket

Buchse

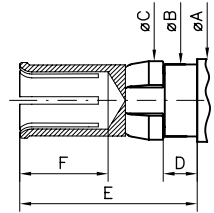
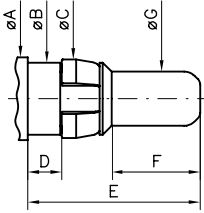

	Plug / Stecker		Socket / Buchse			
	min	max.	min	Modi. U*	max.	Modi. U*
ØA	—	5,50 (0.217)	—	—	5,50 (0.217)	—
ØB	4,75 (0.187)	4,80 (0.189)	4,75 (0.187)	—	4,80 (0.189)	—
ØC	5,00 (0.197)	5,40 (0.213)	5,00 (0.197)	—	5,40 (0.213)	—
D	2,25 (0.089)	2,45 (0.096)	2,25 (0.089)	2,10 (0.083)	2,45 (0.096)	2,25 (0.089)
E	—	11,40 (0.449)	—	—	11,80 (0.465)	11,50 (0.453)
F	5,85 (0.230)	5,90 (0.232)	5,80 (0.228)	—	6,00 (0.236)	—
ØG	3,57 (0.141)	3,60 (0.142)	—	—	—	—

Modification U* please see page 26

Modifikation U* siehe Seite 26



High Power Contacts, Straight Cable Termination, Solder

Hochstromkontakte, gerader Kabelanschluss, Löten

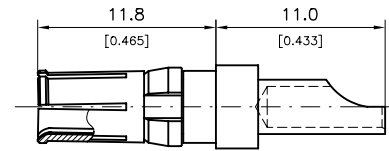
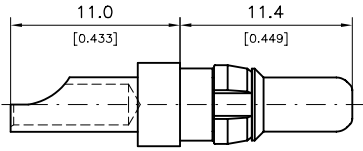

Order Number Plug <i>Bestellnummer Stecker</i>	Type <i>Ausführung</i>	Platings / <i>Oberflächen</i>		Wire Size <i>Kabelgröße</i>	Current Rating <i>max. Strom</i>	Order Number Receptacles <i>Bestellnummer Steckdose</i>
		Mating Area <i>Steckbereich</i>	Termination Area <i>Anschlussbereich</i>			
FMP005P103	standard	0,8 µm Au	0,2 µm Au	AWG 16 - 20	10 A	FMP005S103
FMP005P105	low cost	0,2 µm Au	5 µm Sn			FMP005S105
FMP005P204	standard	AuroPur	0,2 µm Au	AWG 16 - 20	10 A	FMP005S204
FMP005P203	low cost	AuroPur	5 µm Sn			FMP005S203
FMP006P103	standard	0,8 µm Au	0,2 µm Au	AWG 12 - 16	20 A	FMP006S103
FMP006P105	low cost	0,2 µm Au	5 µm Sn			FMP006S105
FMP105P103	standard	0,8 µm Au	0,2 µm Au	AWG 10 - 12	30 A	FMP105S103
FMP105P105	low cost	0,2 µm Au	5 µm Sn			FMP105S105
FMP007P103	standard	0,8 µm Au	0,2 µm Au	AWG 8 - 12	40 A	FMP007S103
FMP007P105	low cost	0,2 µm Au	5 µm Sn			FMP007S105

Other platings on request

Andere Oberflächen auf Anfrage

8 microinches = $\approx 0,2 \mu\text{m}$

30 microinches = $\approx 0,8 \mu\text{m}$

50 microinches = $\approx 1,3 \mu\text{m}$

200 microinches = $\approx 5 \mu\text{m}$

Dimensions

Abmessungen

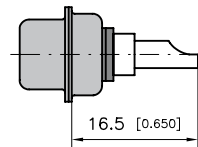
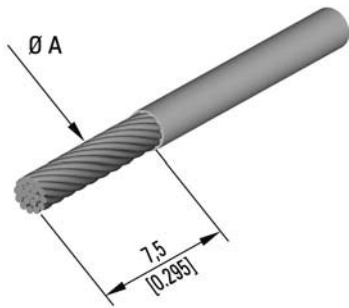

Order Number <i>Bestellnummer</i>	Ø A max.	Max. Metrical Cross-Section Area (sq.in.) <i>max. metrische Querschnittsfläche (mm²)</i>
FMP005...	1,8 (0.071)	2,54 (0.004)
FMP006...	2,7 (0.106)	5,73 (0.009)
FMP105...	3,5 (0.138)	9,60 (0.015)
FMP007...	4,8 (0.189)	18,10 (0.028)



High Power Contacts, Straight Cable Termination, Crimp

Hochstromkontakte, gerader Kabelanschluss, Crimpen

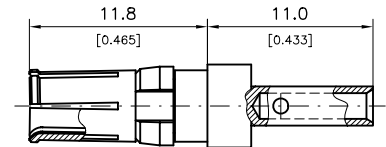
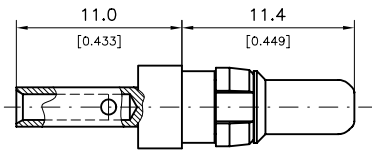

Order Number Plug <i>Bestellnummer Stecker</i>	Type <i>Ausführung</i>	Platings / <i>Oberflächen</i>		Wire Size <i>Kabelgröße</i>	Current Rating <i>max. Strom</i>	Order Number Receptacles <i>Bestellnummer Steckdose</i>
		Mating Area <i>Steckbereich</i>	Termination Area <i>Anschlussbereich</i>			
FMP002P103	standard	0,8 μm Au	0,2 μm Au	AWG 16 - 20	10 A	FMP002S103
FMP002P106	low cost	0,2 μm Au	0,2 μm Au			FMP002S106
FMP002P204	standard	AuroPur	0,2 μm Au	AWG 16 - 20	10 A	FMP002S204
FMP003P103	standard	0,8 μm Au	0,2 μm Au			FMP003S103
FMP003P106	low cost	0,2 μm Au	0,2 μm Au	AWG 12 - 14	20 A	FMP003S106
FMP053P103	standard	0,8 μm Au	0,2 μm Au			FMP053S103
FMP053P106	low cost	0,2 μm Au	0,2 μm Au	AWG 10 - 12	30 A	FMP053S106
FMP004P103	standard	0,8 μm Au	0,2 μm Au			FMP004S103
FMP004P106	low cost	0,2 μm Au	0,2 μm Au	AWG 8 - 10	40 A	FMP004S106

Other platings on request / *Andere Oberflächen auf Anfrage*
Tools from page 94 onwards / *Werkzeuge ab Seite 94 ff.*

8 microinches = $\approx 0,2 \mu\text{m}$
30 microinches = $\approx 0,8 \mu\text{m}$

50 microinches = $\approx 1,3 \mu\text{m}$
200 microinches = $\approx 5 \mu\text{m}$

Dimensions

Abmessungen

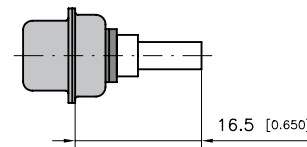
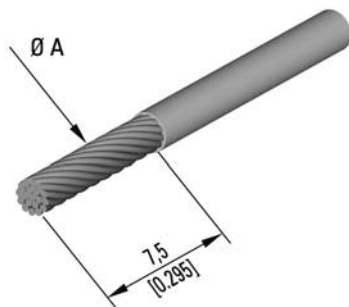

Order Number <i>Bestellnummer</i>	$\varnothing A$ min.	$\varnothing A$ max.	Min. Metrical Cross-Section Area <i>min. metrische Querschnittsfläche</i>	Max. Metrical Cross-Section Area <i>max. metrische Querschnittsfläche</i>
FMP002...	0,9 (0.035)	1,7 (0.067)	0,64 mm ² (0.001 sq.in.)	2,27 mm ² (0.004 sq.in.)
FMP003...	1,8 (0.071)	2,6 (0.102)	2,54 mm ² (0.004 sq.in.)	5,31 mm ² (0.008 sq.in.)
FMP053...	2,2 (0.087)	3,7 (0.146)	3,80 mm ² (0.006 sq.in.)	10,75 mm ² (0.017 sq.in.)
FMP004...	2,9 (0.114)	4,6 (0.181)	6,61 mm ² (0.010 sq.in.)	16,62 mm ² (0.026 sq.in.)



High Power Contacts, Straight PCB Termination

Hochstromkontakte, gerader Leiterplattenanschluss

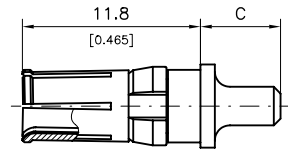
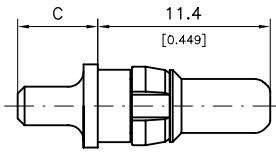

Order Number Plug <i>Bestellnummer Stecker</i>	Type <i>Ausführung</i>	Platings / <i>Oberflächen</i>		Current Rating <i>max. Strom</i>	Order Number Receptacles <i>Bestellnummer Steckdose</i>
		Mating Area <i>Steckbereich</i>	Termination Area <i>Anschlussbereich</i>		
FMP010P104	standard	0,8 μm Au	5 μm Sn	20 A	FMP010S104
FMP010P105	low cost	0,2 μm Au	5 μm Sn		FMP010S105
FMP010P203	low cost	AuroPur	5 μm Sn	20 A	FMP010S203
FMP014P104	standard	0,8 μm Au	5 μm Sn	20 A	FMP014S104
FMP014P105	low cost	0,2 μm Au	5 μm Sn		FMP014S105
FMP016P104	standard	0,8 μm Au	5 μm Sn	40 A	FMP016S104
FMP016P105	low cost	0,2 μm Au	5 μm Sn		FMP016S105

Other platings on request
Andere Oberflächen auf Anfrage

8 microinches = $\approx 0,2 \mu\text{m}$
30 microinches = $\approx 0,8 \mu\text{m}$

50 microinches = $\approx 1,3 \mu\text{m}$
200 microinches = $\approx 5 \mu\text{m}$

Dimensions on the Example FM7W2P1 with High Power Contacts FMP..P.. and Signal Contacts P1

Abmessungen am Beispiel FM7W2P1 mit Hochstromkontakten FMP..P.. und Signalkontakten P1

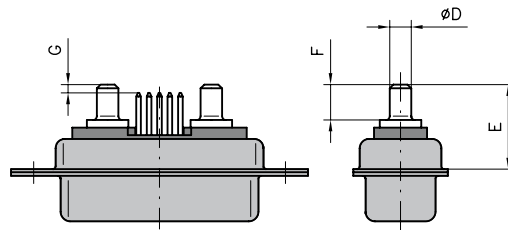

Side view without signal contacts!
Seitenansicht ohne Signalkontakte!

Order Number <i>Bestellnummer</i>	C	Ø D	E	F	G	Drilling Ø <i>Bohrung Ø</i>
FMP010...	4,7 (0.185)	2,85 (0.112)	10,2 (0.402)	3,7 (0.146)	0,1 (0.004)	3,15 (0.124)
FMP014...	5,3 (0.209)	2,60 (0.102)	10,8 (0.425)	4,3 (0.169)	0,7 (0.028)	2,9 (0.114)
FMP016...	5,7 (0.224)	3,75 (0.148)	11,2 (0.441)	4,7 (0.185)	1,1 (0.043)	4,05 (0.159)



High Power Contacts, Right Angled PCB Termination

Hochstromkontakte, abgewinkelter Leiterplattenanschluss

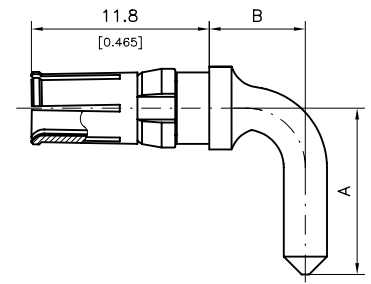
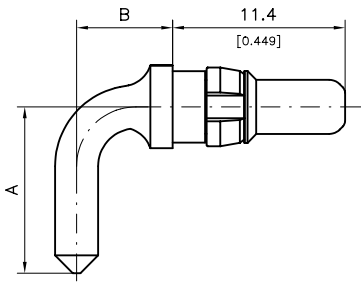

Order Number Plug <i>Bestellnummer Stecker</i>	Type <i>Ausführung</i>	Platings / <i>Oberflächen</i>		Current Rating <i>max. Strom</i>	Order Number Receptacles <i>Bestellnummer Steckdose</i>
		Mating Area <i>Steckbereich</i>	Termination Area <i>Anschlussbereich</i>		
FMP008P104	standard	0,8 μm Au	5 μm Sn	20 A	FMP008S104
FMP008P105	low cost	0,2 μm Au	5 μm Sn		FMP008S105
FMP008P203	low cost	AuroPur	5 μm Sn		FMP008S203
FMP009P104	standard	0,8 μm Au	5 μm Sn	40 A	FMP009S104
FMP009P105	low cost	0,2 μm Au	5 μm Sn		FMP009S105
FMP021P104	standard	0,8 μm Au	5 μm Sn	30 A	FMP021S104
FMP021P105	low cost	0,2 μm Au	5 μm Sn		FMP021S105
FMP062P104	standard	0,8 μm Au	5 μm Sn	20 A	FMP062S104
FMP062P105	low cost	0,2 μm Au	5 μm Sn		FMP062S105
FMP235P104*	standard	0,8 μm Au	5 μm Sn	40 A	FMP235S104*

Other platings on request

Andere Oberflächen auf Anfrage

8 microinches = $\approx 0,2 \mu\text{m}$

30 microinches = $\approx 0,8 \mu\text{m}$

50 microinches = $\approx 1,3 \mu\text{m}$

200 microinches = $\approx 5 \mu\text{m}$

* Contact with increased conductivity

** Kontakt mit erhöhter Leitfähigkeit*

Contacts with knurl for securing in a connector are also available.

Kontakte auch mit Rändel zur Fixierung im Steckverbinder erhältlich.

Dimensions on the Example FM7W2P5 with High Power Contacts FMP...P... and Signal Contacts P5

Abmessungen am Beispiel FM7W2P5 mit Hochstromkontakten FMP...P... und Signalkontakten P5

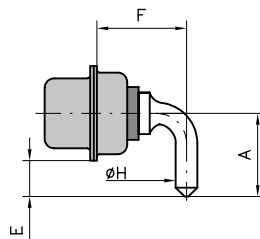
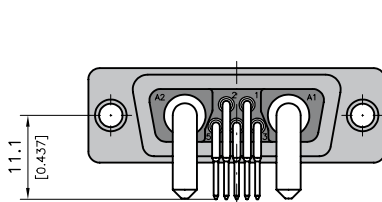

Side view without signal contacts!
Seitenansicht ohne Signalkontakte!

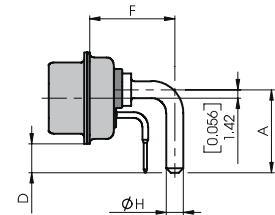

Side view for shell size 5!
Seitenansicht für Gehäusegröße 5!

Order Number <i>Bestellnummer</i>	A	B	D	E	F	Ø H	Drilling Ø <i>Bohrung Ø</i>
FMP008...	11,0 (0.433)	6,3 (0.248)	—	4,75 (0.187)	11,8 (0.465)	2,85 (0.112)	3,15 (0.124)
FMP009...	11,0 (0.433)	6,30 (0.248)	—	4,8 (0.187)	11,80 (0.465)	3,75 (0.148)	4,05 (0.159)
FMP021...	9,5 (0.374)	15,0 (0.591)	—	3,25 (0.128)	20,5 (0.807)	3,20 (0.126)	3,50 (0.138)
FMP062...	14,0 (0.551)	8,85 (0.348)	4,9 (0.193)	—	14,35 (0.565)	2,85 (0.112)	3,15 (0.124)
FMP235...	10,8 (0.425)	5,1 (0.201)	—	4,55 (0.179)	10,6 (0.417)	2,85 (0.112)	3,15 (0.124)



High Power Contacts, Straight PCB Termination with Flexible Press-fit

Hochstromkontakte, gerader Leiterplattenanschluss mit flexibler Einpresszone

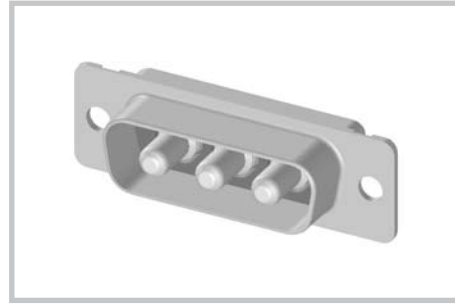
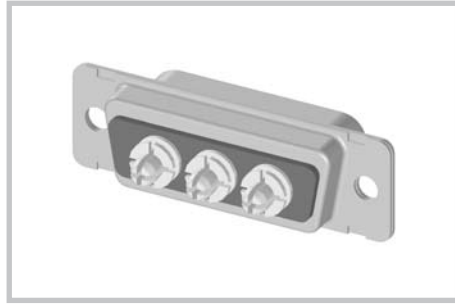

Features

Merkmale

- For PCBs up to 0.078 " (lesser thickness available on request)
- Suitable for multi layer PCBs
- Quick solder-free assembly
- Low insertion forces
- For use up to 30 A
- High retention forces
- Für Leiterplatten ab 2 mm (kleinere Stärken auf Anfrage)
- Geeignet für Multi Layer Leiterplatten
- Schnelle lötfreie Montage
- Geringe Einbaukräfte
- Verwendbar bis 30 A
- Hohe Haltekräfte

Longitudinal Section PCB

Längsschnitt durch die Leiterplatte

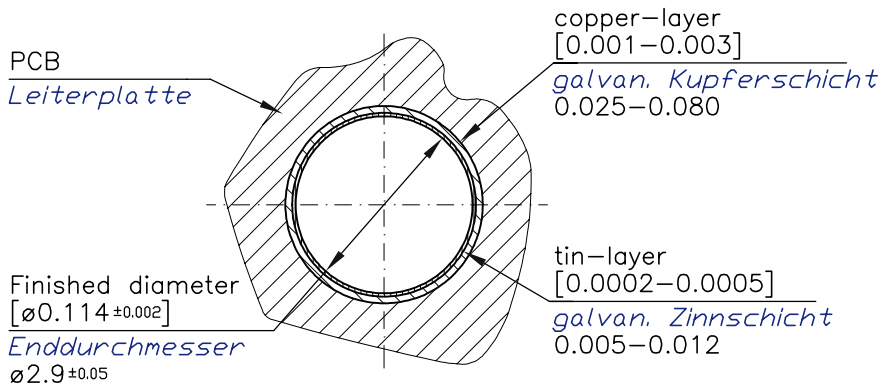

Straight High Power Contact with Flexible Press-fit

Gerader Hochstromkontakt mit flexibler Einpresszone

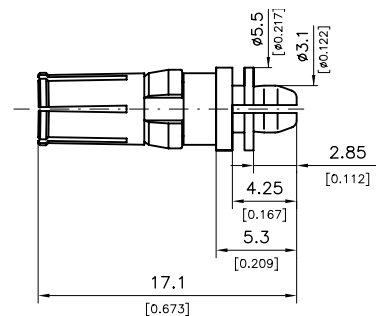
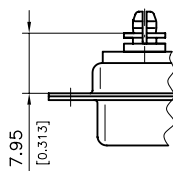
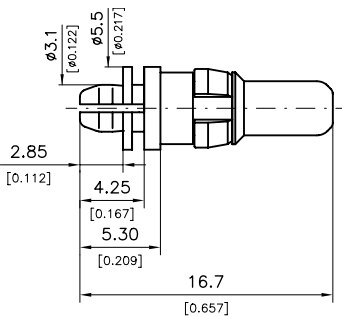

Order Number Plug <i>Bestellnummer Stecker</i>	Type <i>Ausführung</i>	Platings / Oberflächen		Current Rating <i>max. Strom</i>	Order Number Receptacles <i>Bestellnummer Steckdose</i>
		Mating Area <i>Steckbereich</i>	Termination Area <i>Anschlussbereich</i>		
FMP094P141	standard	0,8 μ m Au	1 μ m Sn	30 A	FMP094S141
FMP094P140	low cost	0,2 μ m Au	1 μ m Sn		FMP094S140

Other platings on request
Andere Oberflächen auf Anfrage

8 microinches = $\approx 0,2 \mu$ m
30 microinches = $\approx 0,8 \mu$ m

50 microinches = $\approx 1,3 \mu$ m
200 microinches = $\approx 5 \mu$ m



High Power Contacts, Right Angled PCB Termination with Flexible Press-fit

Hochstromkontakte, abgewinkelter Leiterplattenanschluss mit flexibler Einpresszone

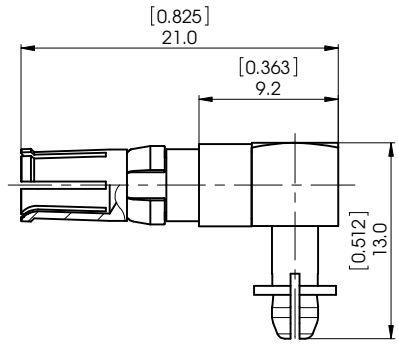
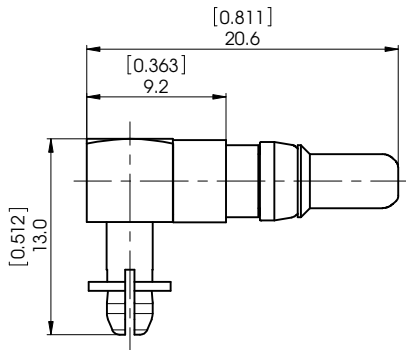

Order Number Plug <i>Bestellnummer Stecker</i>	Type <i>Ausführung</i>	Platings / <i>Oberflächen</i>		Current Rating <i>max. Strom</i>	Order Number Receptacles <i>Bestellnummer Steckdose</i>
		Mating Area <i>Steckbereich</i>	Termination Area <i>Anschlussbereich</i>		
FMP133P141	standard	0,8 μm Au	1 μm Sn	30 A	FMP133S141
FMP133P140	low cost	0,2 μm Au	1 μm Sn		FMP133S140
Other platings on request <i>Andere Oberflächen auf Anfrage</i>		8 microinches = ≈0,2 μm 30 microinches = ≈0,8 μm			50 microinches = ≈1,3 μm 200 microinches = ≈5 μm

High Power Contacts, Early Make Late Break, Ø 2.7 mm (Ø 0.106")

Hochstromkontakte, Early make Late break, Ø 2,7 mm

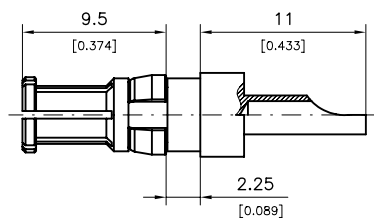
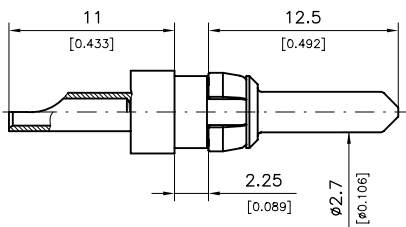

Order Number Plug <i>Bestellnummer Stecker</i>	Type <i>Ausführung</i>	Platings / <i>Oberflächen</i>		Current Rating <i>max. Strom</i>	Wire Size <i>Kabelgröße</i>	Order Number Receptacles <i>Bestellnummer Steckdose</i>
		Mating Area <i>Steckbereich</i>	Termination Area <i>Anschlussbereich</i>			
FMA026P103	standard	0,8 μm Au	0,2 μm Au	10 A	AWG 16 - 20	FMA026S103
FMA026P105	low cost	0,2 μm Au	5 μm Sn			FMA026S105
FMA026P203	low cost	AuroPur	5 μm Sn	10 A	AWG 16 - 20	FMA026S203
Other platings on request <i>Andere Oberflächen auf Anfrage</i>		8 microinches = ≈0,2 μm 30 microinches = ≈0,8 μm			50 microinches = ≈1,3 μm 200 microinches = ≈5 μm	

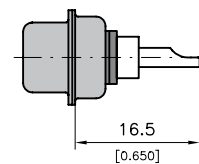
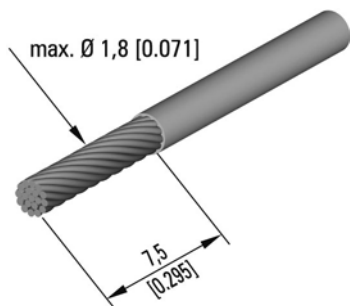



Connectors with High Power Contacts with Semi Flexible Press-fit

Steckverbinder mit Hochstromkontakten mit semiflexibler Einpresszone

Dimensions on an example connector with hole pattern 5W5 and high power contacts FMP334S1041R.

Abmessungen am Beispiel eines Steckverbinders mit Polbild 5W5 und Hochstromkontakten FMP334S1041R.

Further hole patterns available

Weitere Polbilder verfügbar.

Connector FM5W5S-3478

Steckverbinder FM5W5S-3478

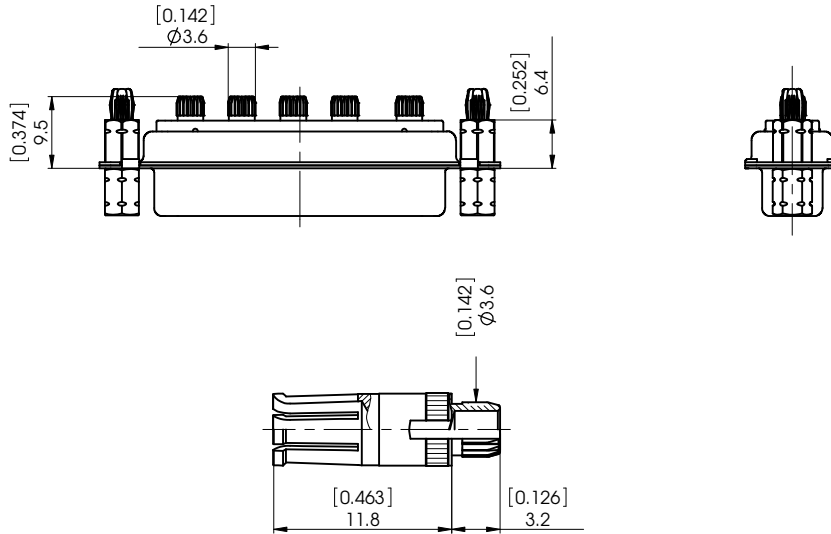

Order Number Plug <i>Bestellnummer Stecker</i>	Type <i>Ausführung</i>	Platings / <i>Oberflächen</i>		Current Rating <i>max. Strom</i>	Order Number Receptacles <i>Bestellnummer Steckdose</i>
		Mating Area <i>Steckbereich</i>	Termination Area <i>Anschlussbereich</i>		
FMP334P1041R	standard	0,8 μm Au	5,0 μm Sn	30 A	FMP334S1041R

Cross-section PCB for Press-fit-contact

Leiterplattenquerschnitt für Einpresskontakt

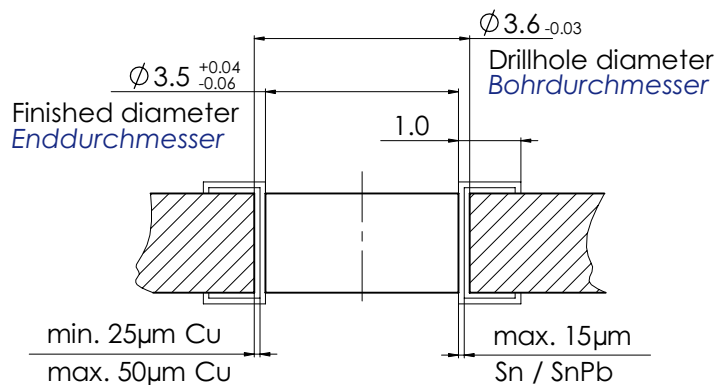

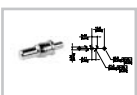

PCB Hole Pattern for Connectors with Straight PCB Terminations

Leiterplattenlochbild für Steckverbinder mit geradem Leiterplattenanschluss

All PCB hole patterns apply to pin connectors with straight PCB terminations (signal contacts P1). When using female connectors the hole pattern must be mirrored on the Y-axis.

Measurements without tolerances are in accordance with DIN ISO 2768 m. For the required drilling diameters see page 68 and 70.

Alle Lochbilder gelten für Stiftsteckverbinder mit geradem Leiterplattenanschluss (Signalkontakte P1). Bei Verwendung von Buchsensteckverbindern muss das Lochbild an der Y-Achse gespiegelt werden.

Maße ohne Toleranzangabe nach DIN ISO 2768 m. Erforderlicher Bohrungsdurchmesser siehe Seite 68 und 70.

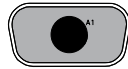

F1W1

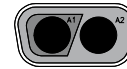
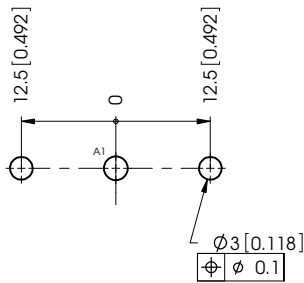

F2W2...C / FM2W2

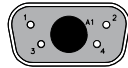
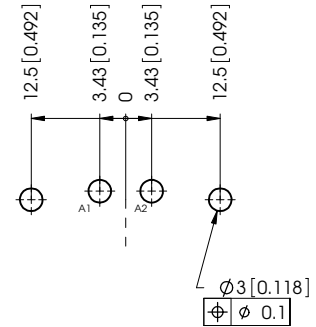

FM5W1

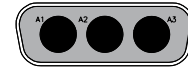
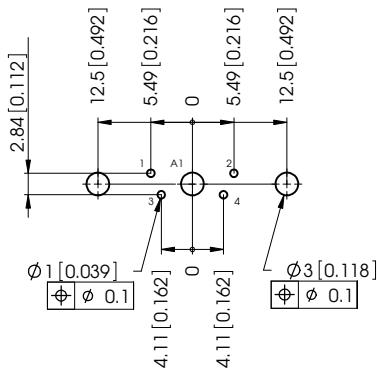

FM3W3 / F3W3...C

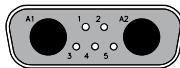
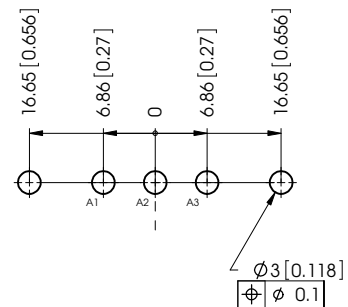

FM7W2

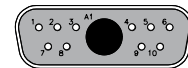
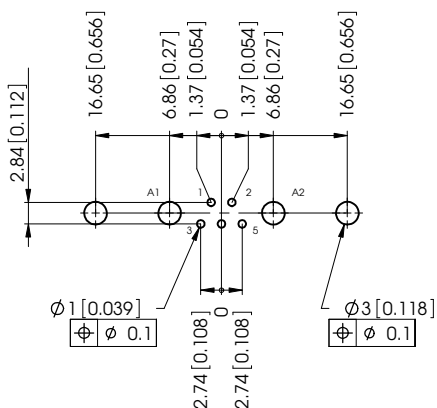

FM11W1

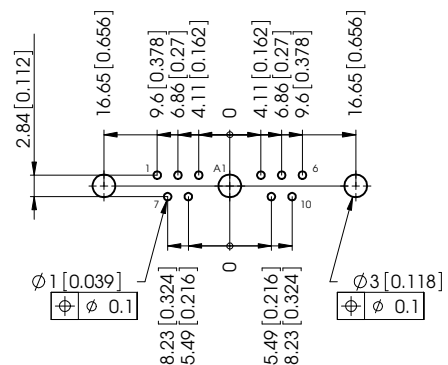



PCB Hole Pattern for Connectors with Straight PCB Terminations

Leiterplattenlochbild für Steckverbinder mit geradem Leiterplattenanschluss

All PCB hole patterns apply to pin connectors with straight PCB terminations (signal contacts P1). When using female connectors the hole pattern must be mirrored on the Y-axis.

Measurements without tolerances are in accordance with DIN ISO 2768 m. For the required drilling diameters see page 68 and 70.

Alle Lochbilder gelten für Stiftsteckverbinder mit geradem Leiterplattenanschluss (Signalkontakte P1). Bei Verwendung von Buchsensteckverbindern muss das Lochbild an der Y-Achse gespiegelt werden.

Maße ohne Toleranzangabe nach DIN ISO 2768 m. Erforderlicher Bohrungsdurchmesser siehe Seite 68 und 70.

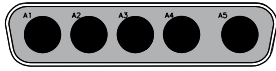

FM5W5

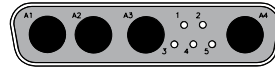
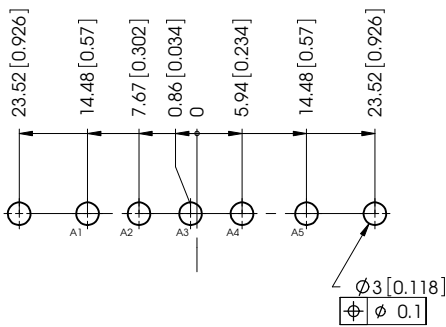

FM9W4

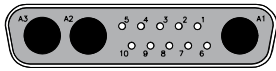
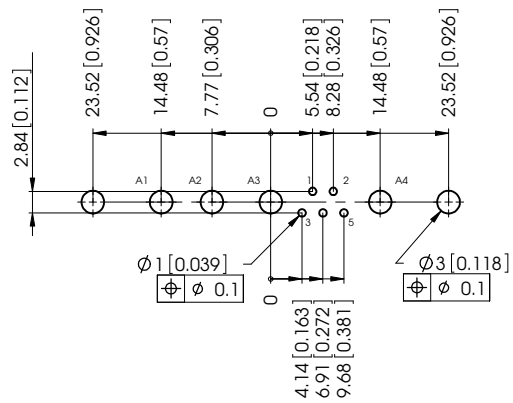

FM13W3

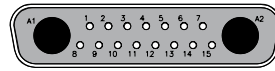
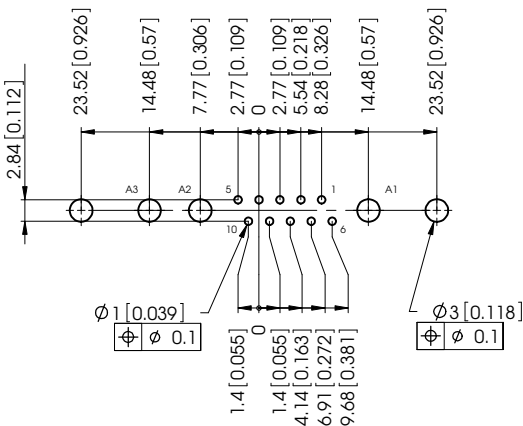

FM17W2

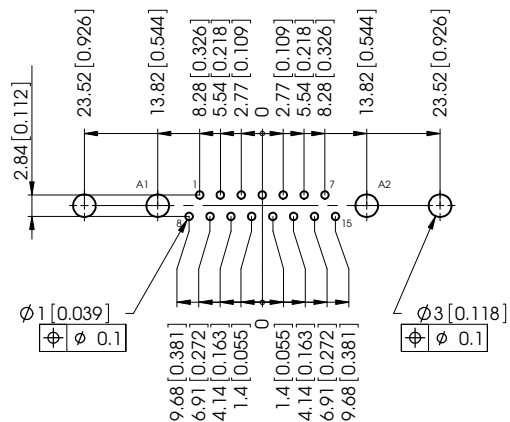

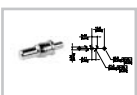

PCB Hole Pattern for Connectors with Straight PCB Terminations

Leiterplattenlochbild für Steckverbinder mit geradem Leiterplattenanschluss

All PCB hole patterns apply to pin connectors with straight PCB terminations (signal contacts P1). When using female connectors the hole pattern must be mirrored on the Y-axis.

Measurements without tolerances are in accordance with DIN ISO 2768 m. For the required drilling diameters see page 68 and 70.

Alle Lochbilder gelten für Stiftsteckverbinder mit geradem Leiterplattenanschluss (Signalkontakte P1). Bei Verwendung von Buchsensteckverbindern muss das Lochbild an der Y-Achse gespiegelt werden.

Maße ohne Toleranzangabe nach DIN ISO 2768 m. Erforderlicher Bohrungsdurchmesser siehe Seite 68 und 70.

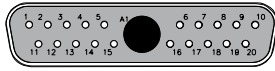

FM21W1

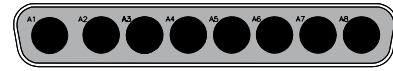
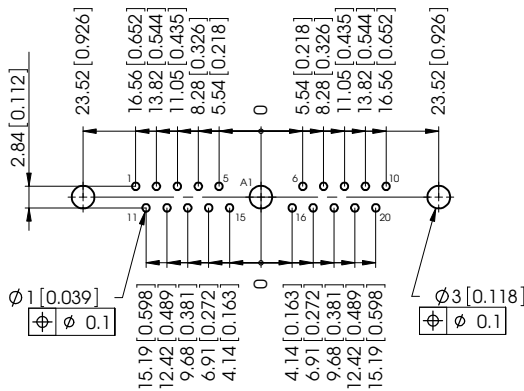

FM8W8

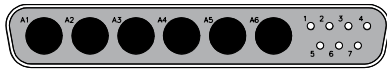
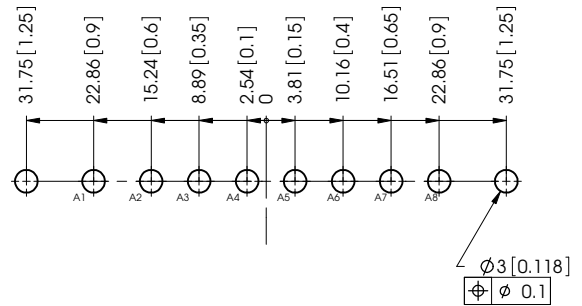

FM13W6

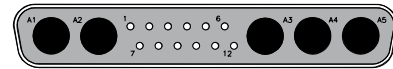
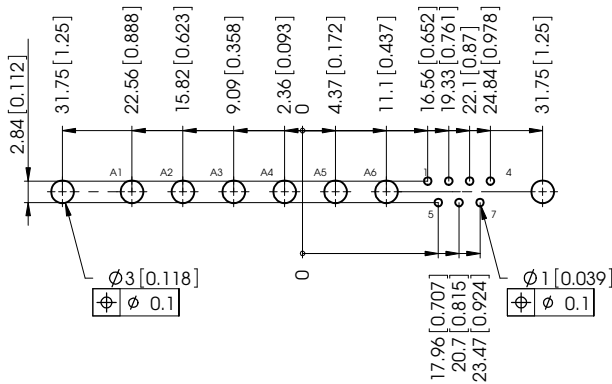

FM17W5

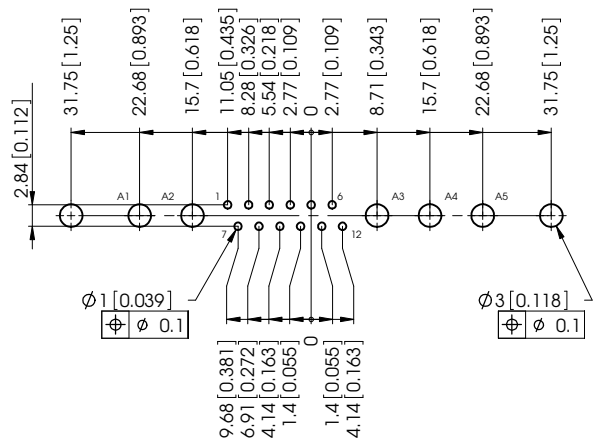



PCB Hole Pattern for Connectors with Straight PCB Terminations

Leiterplattenlochbild für Steckverbinder mit geradem Leiterplattenanschluss

All PCB hole patterns apply to pin connectors with straight PCB terminations (signal contacts P1). When using female connectors the hole pattern must be mirrored on the Y-axis.

Measurements without tolerances are in accordance with DIN ISO 2768 m. For the required drilling diameters see page 68 and 70.

Alle Lochbilder gelten für Stiftsteckverbinder mit geradem Leiterplattenanschluss (Signalkontakte P1). Bei Verwendung von Buchsensteckverbindern muss das Lochbild an der Y-Achse gespiegelt werden.

Maße ohne Toleranzangabe nach DIN ISO 2768 m. Erforderlicher Bohrungsdurchmesser siehe Seite 68 und 70.

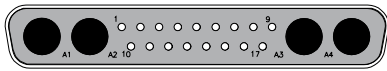

FM21WA4

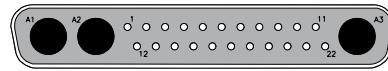
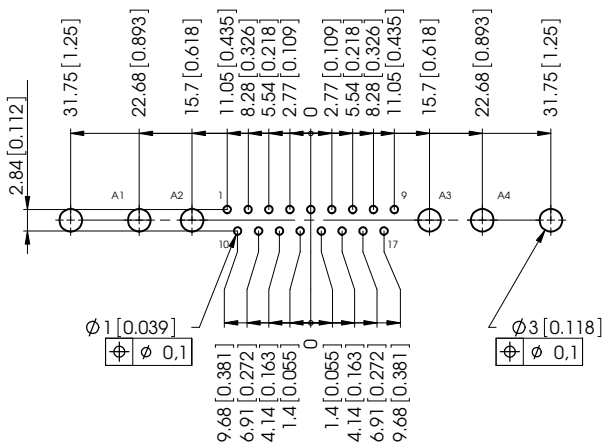

FM25W3

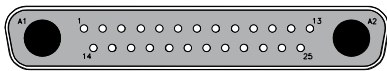
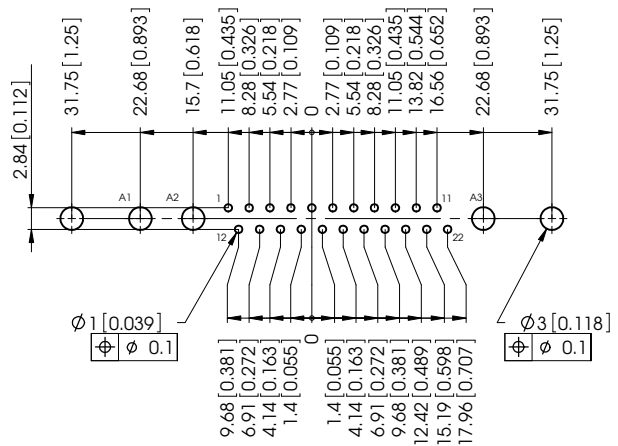

FM27W2

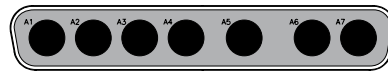
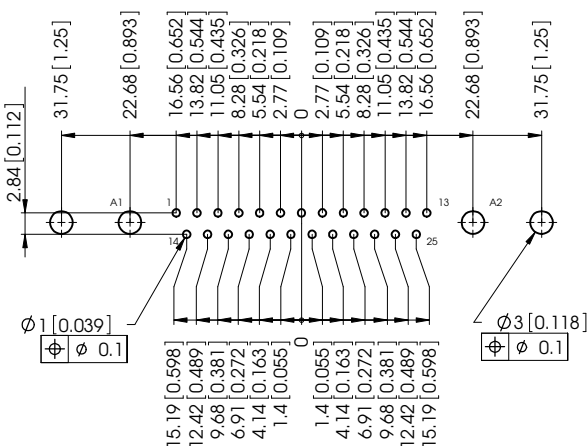

F7W7

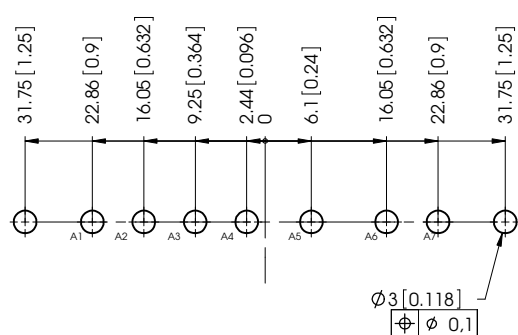

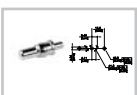

PCB Hole Pattern for Connectors with Straight PCB Terminations

Leiterplattenlochbild für Steckverbinder mit geradem Leiterplattenanschluss

All PCB hole patterns apply to pin connectors with straight PCB terminations (signal contacts P1). When using female connectors the hole pattern must be mirrored on the Y-axis.

Measurements without tolerances are in accordance with DIN ISO 2768 m. For the required drilling diameters see page 68 and 70.

Alle Lochbilder gelten für Stiftsteckverbinder mit geradem Leiterplattenanschluss (Signalkontakte P1). Bei Verwendung von Buchsensteckverbindern muss das Lochbild an der Y-Achse gespiegelt werden.

Maße ohne Toleranzangabe nach DIN ISO 2768 m. Erforderlicher Bohrungsdurchmesser siehe Seite 68 und 70.

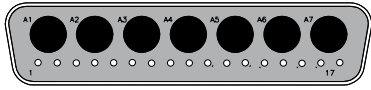

FM24W7

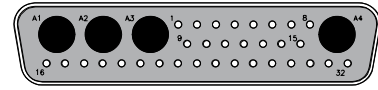
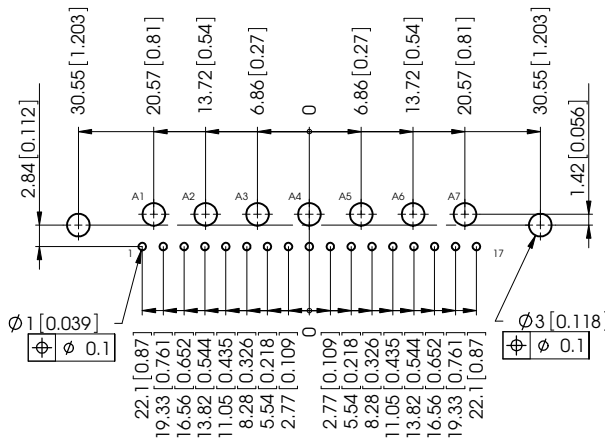

FM36W4

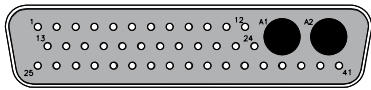
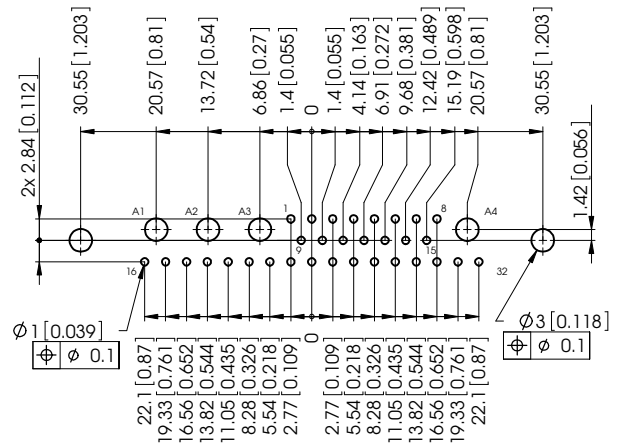

FM43W2

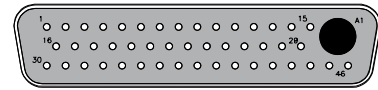
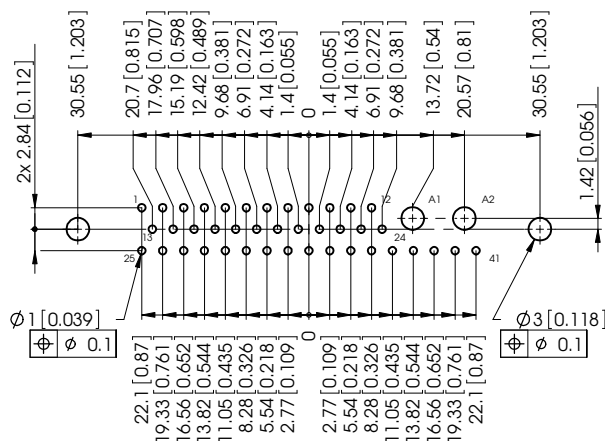

FM47W1

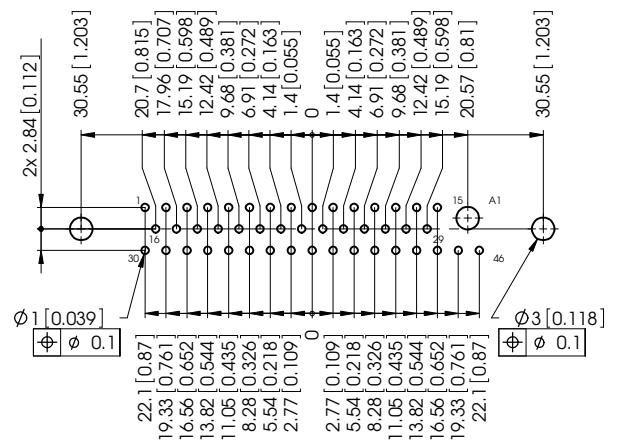

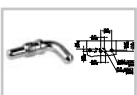

PCB Hole Pattern for Connectors with Right Angled PCB Terminations

Leiterplattenlochbild für Steckverbinder mit abgewinkelttem Leiterplattenanschluss

All PCB hole patterns apply to male connectors with right angled PCB terminations (signal contacts P5) with metal brackets F1080-13B. When using female connectors the hole pattern must be mirrored on the Y-axis.

Measurements without tolerances are in accordance with DIN ISO 2768 m. For the required dimension F and drilling diameters see page 69 and 70.

Alle Lochbilder gelten für Stiftsteckverbinder mit abgewinkelttem Leiterplattenanschluss (Signalkontakte P5) und Metallwinkel F1080-13B. Bei Verwendung von Buchsensteckverbindern muss das Lochbild an der Y-Achse gespiegelt werden.

Maße ohne Toleranzangabe nach DIN ISO 2768 m. Erforderliches Maß F und Bohrungsdurchmesser siehe Seite 69 und 70.

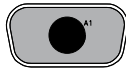

F1W1

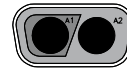
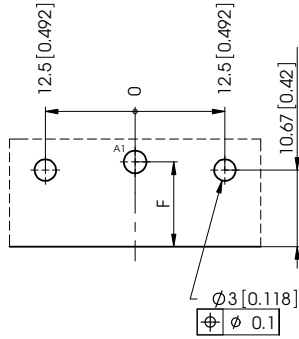

F2W2...C / FM2W2

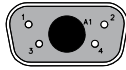
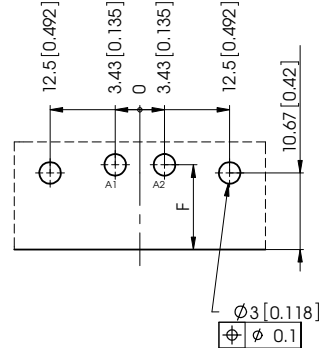

FM5W1

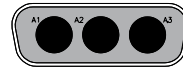
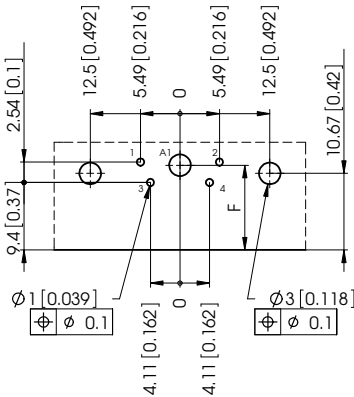

FM3W3 / F3W3...C

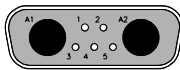
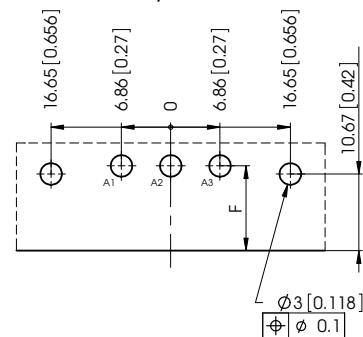

FM7W2

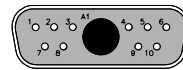
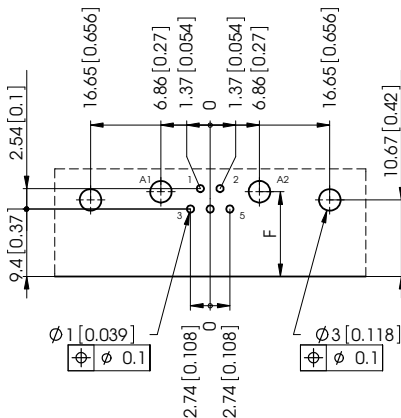

FM11W1

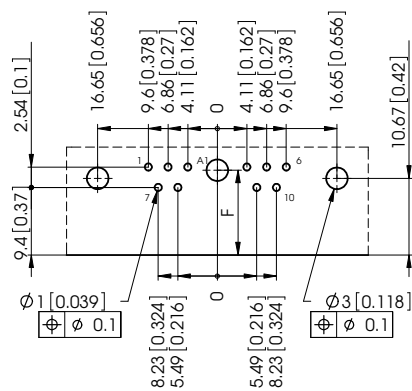



PCB Hole Pattern for Connectors with Right Angled PCB Terminations

Leiterplattenlochbild für Steckverbinder mit abgewinkelttem Leiterplattenanschluss

All PCB hole patterns apply to male connectors with right angled PCB terminations (signal contacts P5) with metal brackets F1080-13B. When using female connectors the hole pattern must be mirrored on the Y-axis.

Measurements without tolerances are in accordance with DIN ISO 2768 m. For the required dimension F and drilling diameters see page 69 and 70.

Alle Lochbilder gelten für Stiftsteckverbinder mit abgewinkelttem Leiterplattenanschluss (Signalkontakte P5) und Metallwinkel F1080-13B. Bei Verwendung von Buchsensteckverbindern muss das Lochbild an der Y-Achse gespiegelt werden.

Maße ohne Toleranzangabe nach DIN ISO 2768 m. Erforderliches Maß F und Bohrungsdurchmesser siehe Seite 69 und 70.

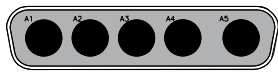

FM5W5

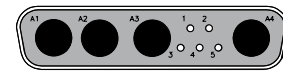
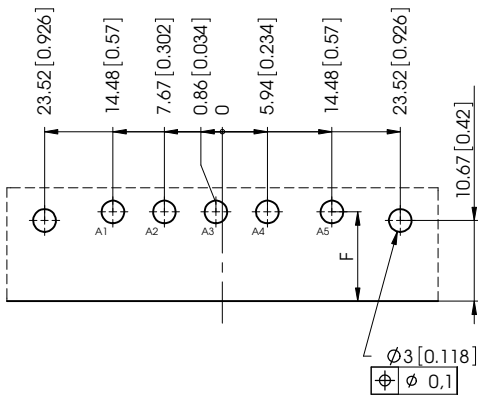

FM9W4

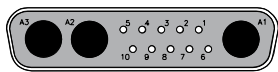
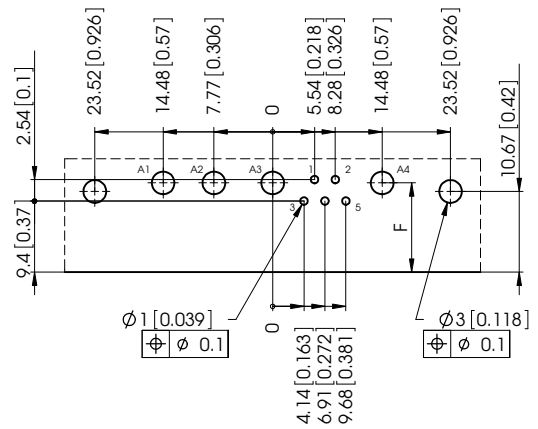

FM13W3

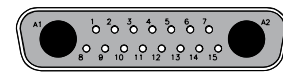
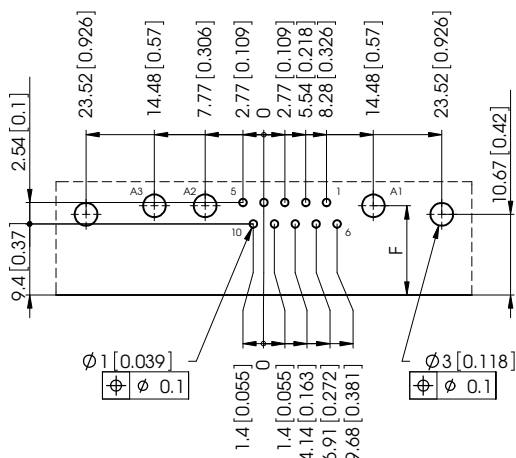

FM17W2

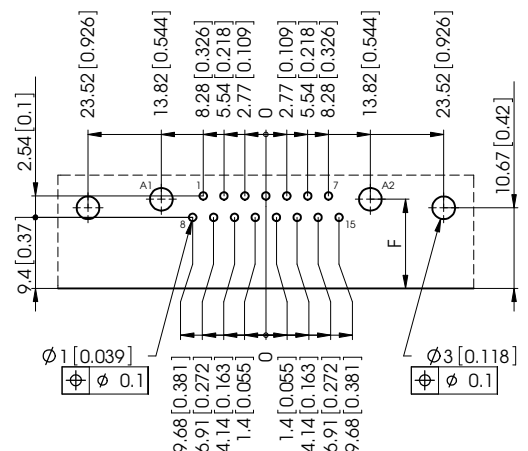



PCB Hole Pattern for Connectors with Right Angled PCB Terminations

Leiterplattenlochbild für Steckverbinder mit abgewinkeltm Leiterplattenanschluss

All PCB hole patterns apply to male connectors with right angled PCB terminations (signal contacts P5) with metal brackets F1080-13B. When using female connectors the hole pattern must be mirrored on the Y-axis.

Measurements without tolerances are in accordance with DIN ISO 2768 m. For the required dimension F and drilling diameters see page 69 and 70.

Alle Lochbilder gelten für Stiftsteckverbinder mit abgewinkeltm Leiterplattenanschluss (Signalkontakte P5) und Metallwinkel F1080-13B. Bei Verwendung von Buchsensteckverbindern muss das Lochbild an der Y-Achse gespiegelt werden.

Maße ohne Toleranzangabe nach DIN ISO 2768 m. Erforderliches Maß F und Bohrungsdurchmesser siehe Seite 69 und 70.

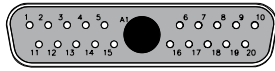

FM21W1

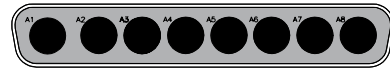
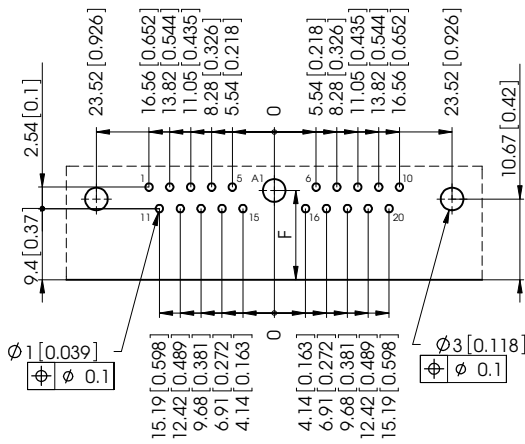

FM8W8

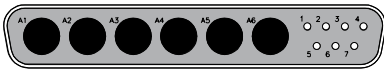
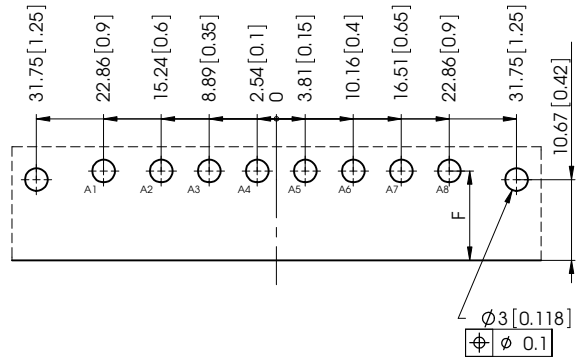

FM13W6

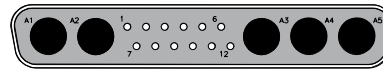
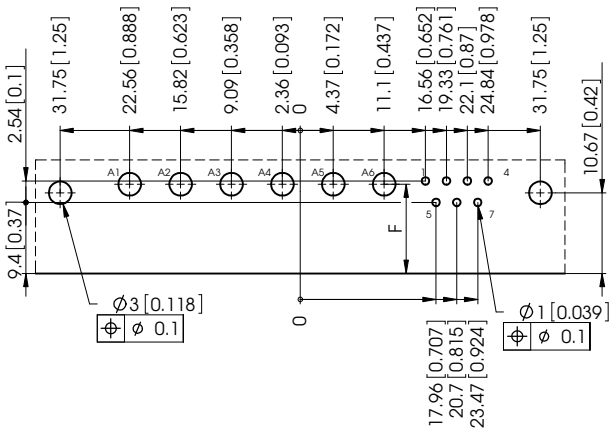

FM17W5

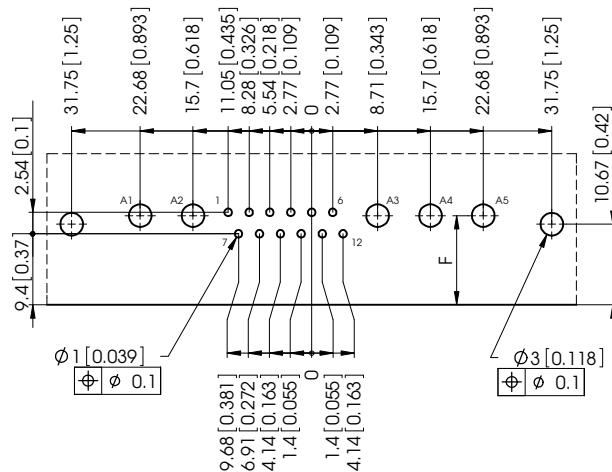



PCB Hole Pattern for Connectors with Right Angled PCB Terminations

Leiterplattenlochbild für Steckverbinder mit abgewinkelttem Leiterplattenanschluss

All PCB hole patterns apply to male connectors with right angled PCB terminations (signal contacts P5) with metal brackets F1080-13B. When using female connectors the hole pattern must be mirrored on the Y-axis.

Measurements without tolerances are in accordance with DIN ISO 2768 m. For the required dimension F and drilling diameters see page 69 and 70.

Alle Lochbilder gelten für Stiftsteckverbinder mit abgewinkelttem Leiterplattenanschluss (Signalkontakte P5) und Metallwinkel F1080-13B. Bei Verwendung von Buchsensteckverbindern muss das Lochbild an der Y-Achse gespiegelt werden.

Maße ohne Toleranzangabe nach DIN ISO 2768 m. Erforderliches Maß F und Bohrungsdurchmesser siehe Seite 69 und 70.

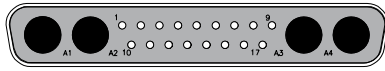

FM21WA4

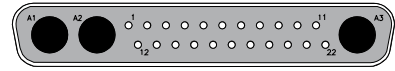
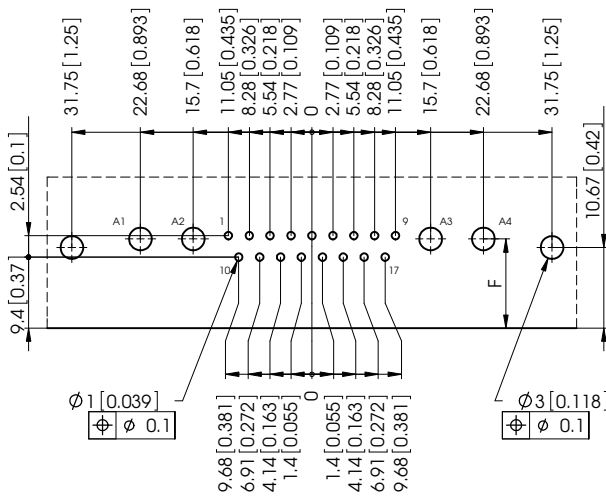

FM25W3

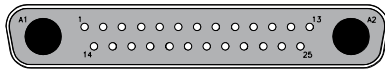
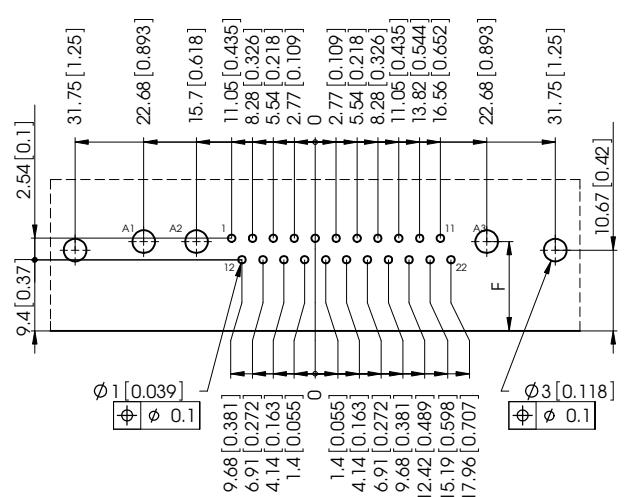

FM27W2

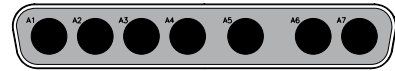
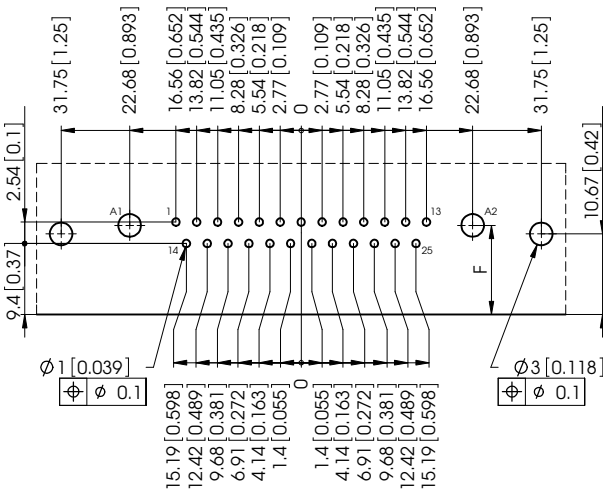

F7W7

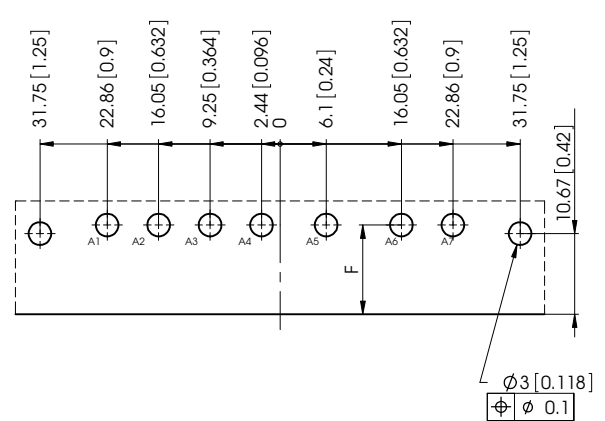

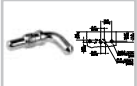

PCB Hole Pattern for Connectors with Right Angled PCB Terminations

Leiterplattenlochbild für Steckverbinder mit abgewinkeltm Leiterplattenanschluss

All PCB hole patterns apply to male connectors with right angled PCB terminations (signal contacts P5) with metal brackets F1080-23. When using female connectors the hole pattern must be mirrored on the Y-axis.

Measurements without tolerances are in accordance with DIN ISO 2768 m. For the required dimension F and drilling diameters see page 69 and 70.

Alle Lochbilder gelten für Stiftsteckverbinder mit abgewinkeltm Leiterplattenanschluss (Signalkontakte P5) und Metallwinkel F1080-23. Bei Verwendung von Buchsensteckverbindern muss das Lochbild an der Y-Achse gespiegelt werden.

Maße ohne Toleranzangabe nach DIN ISO 2768 m. Erforderliches Maß F und Bohrungsdurchmesser siehe Seite 68 und 70.

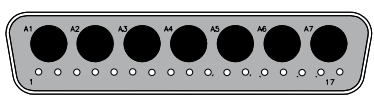

FM24W7

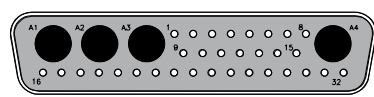
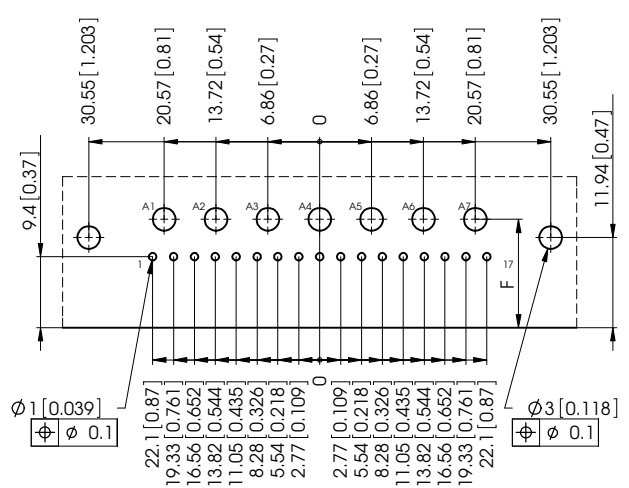

FM36W4

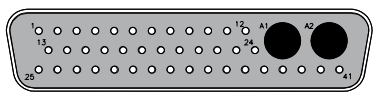
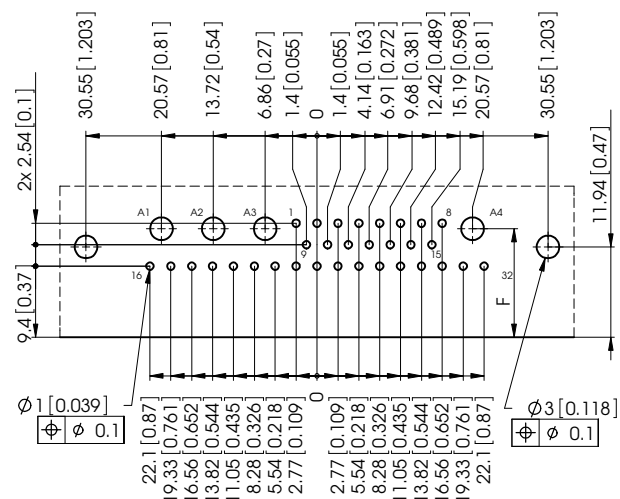

FM43W2

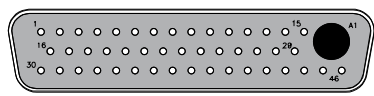
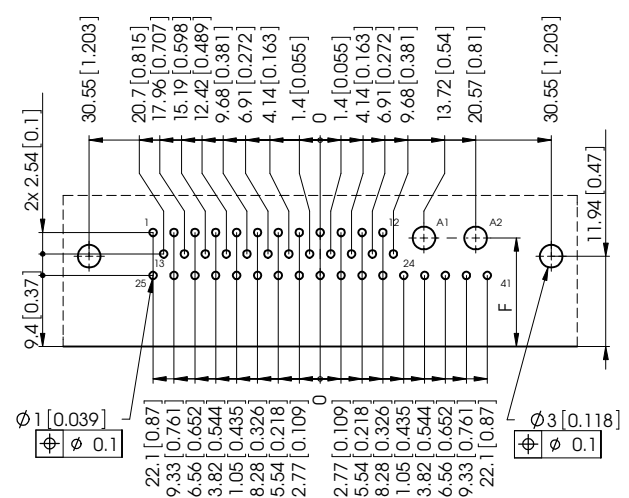

FM47W1

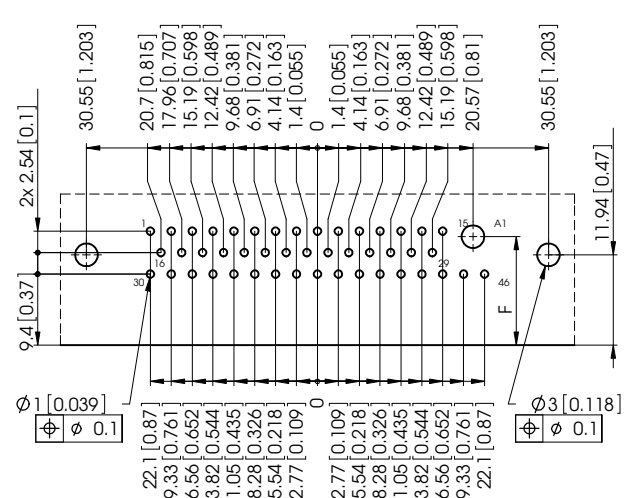

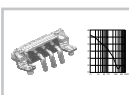

D-Sub Mixed Layout Filter Connectors with High Power Contacts

D-Sub Mixed Layout Filtersteckverbinder mit Hochstromkontakten

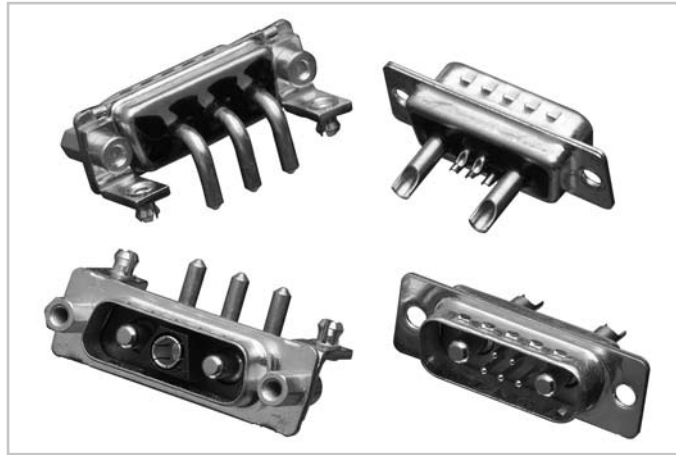

In addition to D-Sub standard filter connectors, FCT can now supply **mixed layout and mono block connectors in a filtered version**. According to requirement high power contacts and - depending on their hole patterns - also signed contacts can be filtered. Ceramic feed through capacitors are used as filters. The capacitors range from 100 pF (Standard capacity 1 nF) up to 56 nF. All filter connectors are available in male and female versions with varying terminations (PCB and solder pot). A multiple supply of accessories is available in the usual FCT wide range. Modifications and selective filtering are also possible.

*Neben den gefilterten D-Sub Standardsteckverbindern sind bei FCT auch **Mischpulleisten und Monoblocksteckverbinder in gefilterter Version** erhältlich. Je nach Anforderung können die Hochstromkontakte und - abhängig vom Polbild - auch die Signalkontakte gefiltert werden. Als Filter dienen keramische Durchführungskondensatoren. Die Kapazitäten reichen von 100 pF (Standardkapazität: 1 nF) bis zu 56 nF. Alle Filtersteckverbinder sind als Stift- und Buchsenversion mit verschiedenen Anschlussarten (Einlöt- und Löttopfversion) erhältlich. Das vielfältige Angebot an Zubehör ist in gewohntem FCT-Umfang lieferbar. Sonderanfertigungen wie selektive Filterung sind möglich.*



Please see also our catalogue "D-Sub Filter Connectors and EMI/EMV products".
Siehe auch in unserem Katalog "D-Sub Filterstecker und weitere EMV-Produkte".

Typical Loss vs. Frequency (50 Ohm line, 1 nF)

Typisches Dämpfungsverhalten (50 Ohm System, 1 nF)

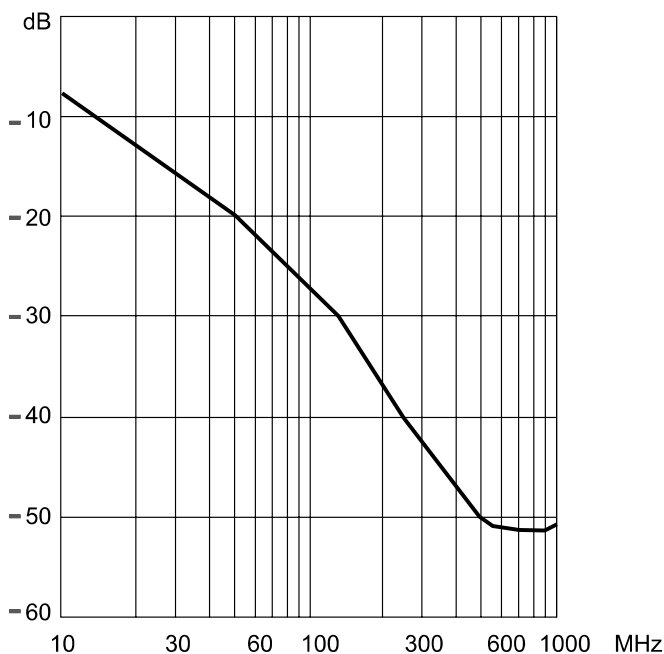

Features

Merkmale

- Facilitates the development of EMI/EMC approved designs
- Space saving
- Tin plated steel shells (with dimples for higher frequencies - male connectors only)
- Low pass filter with minimal attenuation in the transmission band
- Ceramic capacitor
- Standard versions and many modified designs available
- The ground plane enables additional RF shielding
- *erleichtert EMV-gerechtes Design*
- *platzsparend*
- *verzinntes Stahlgehäuse (bei Stiftsteckverbindern mit Kontaktnoppen für hohe Frequenzen)*
- *Tiefpassfilter mit minimaler Dämpfung im Durchlaßbereich*
- *Keramikkondensator*
- *Standardausführungen und Sonderanfertigungen verfügbar*
- *zusätzliche HF-Dichtheit durch „ground plane“*



High Voltage Contacts

Hochspannungskontakte

Technical Data

Technische Daten

Mechanical Data

Mechanische Daten

Mechanical Data <i>Mechanische Daten</i>	
Mating force <i>Steckkraft</i>	≤ 5 N
Unmating force <i>Ziehkraft</i>	≥ 0,2 N
Temperature range <i>Temperaturbereich</i>	-55 °C to 125 °C (-67 °F to 257 °F) <i>-55 °C bis 125 °C</i>
Mating cycles performance class 1 <i>Steckzyklen Anforderungsstufe 1</i> - Other versions on request <i>- Andere Ausführungen auf Anfrage</i>	≥ 500

Electrical Data

Elektrische Daten

Electrical Data <i>Elektrische Daten</i>	
Insulation resistance <i>Isolationswiderstand</i>	≥ 2 * 10 ⁷ MΩ
Proof test voltage <i>Spannungsfestigkeit</i>	4 kV / 50 Hz
Current rating (DC) <i>Max. Kontaktstrom (DC)</i>	2 A
Operating voltage <i>Betriebsspannung</i>	≤ 3 kV

Materials

Materialien

Materials <i>Materialien</i>	
Plug <i>Stecker</i>	Cu alloy <i>Cu Legierung</i>
Receptacle <i>Steckdose</i>	Cu alloy <i>Cu Legierung</i>
Retaining clip <i>Halteclip</i>	PEI Polyetherimide <i>PEI Polyetherimid</i>
Insulators <i>Isolierteile</i>	PTFE



Plugs or pin contacts may only be mounted in male connectors, receptacles or sockets may only be mounted in female connectors.
Stecker bzw. Stiftkontakte (P) dürfen nur in Messerleisten, Steckdosen bzw. Buchsenkontakte (S) nur in Federleisten montiert werden.



High Voltage Contacts, Straight Cable Termination, Solder

Hochspannungskontakte, gerader Kabelanschluss, Löten

Plug P

Stecker P

Receptacle S

Steckdose S

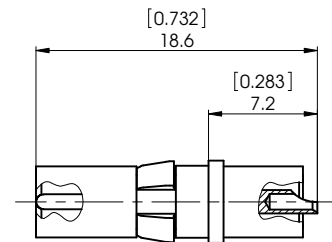
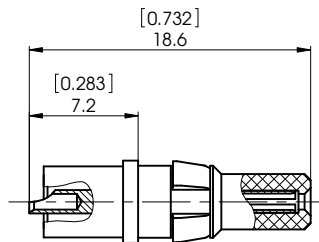

Order No. Plug <i>Bestell Nr. Stecker</i>	Suitable Cables <i>Verwendbare Kabel</i>	Order No. Receptacle <i>Bestell Nr. Steckdose</i>
Performance Class / <i>Anforderungsstufe</i> 1		Performance Class / <i>Anforderungsstufe</i> 1
FMV001P107K	≤ AWG 20	FMV001S107K

High Voltage Contacts, Right Angled Cable Termination, Solder

Hochspannungskontakte, abgewinkelter Kabelanschluss, Löten

Plug P

Stecker P

Receptacle S

Steckdose S

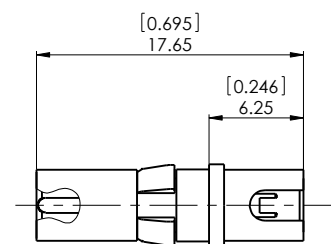
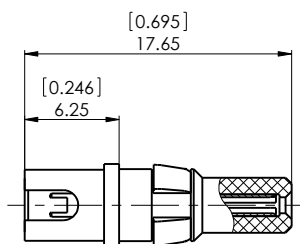

Order No. Plug <i>Bestell Nr. Stecker</i>	Suitable Cables <i>Verwendbare Kabel</i>	Order No. Receptacle <i>Bestell Nr. Steckdose</i>
Performance Class / <i>Anforderungsstufe</i> 1		Performance Class / <i>Anforderungsstufe</i> 1
FMV002P107K	≤ AWG 20	FMV002S107K



High Voltage Contacts, Straight PCB

Hochspannungskontakte, gerader Leiterplattenanschluss

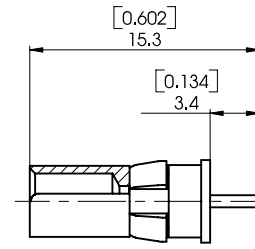
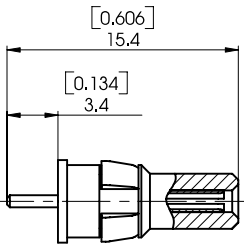

Order Number Plug <i>Bestellnummer Stecker</i>	Type <i>Ausführung</i>	Platings / <i>Oberflächen</i>		Drilling Ø <i>Bohrungs-Ø</i>	Order Number Receptacles <i>Bestellnummer Steckdose</i>
		Mating Area <i>Steckbereich</i>	Termination Area <i>Anschlussbereich</i>		
FMV005P107K	standard	1,3 µm Au	1,3 µm Au	1,0 (0.039)	FMV005S107K

Other platings on request

Andere Oberflächen auf Anfrage

8 microinches = $\approx 0,2 \mu\text{m}$

30 microinches = $\approx 0,8 \mu\text{m}$

50 microinches = $\approx 1,3 \mu\text{m}$

200 microinches = $\approx 5 \mu\text{m}$

High Voltage Contacts, Straight Cable Termination, Crimp

Hochspannungskontakte, gerader Kabelanschluss, Crimpen

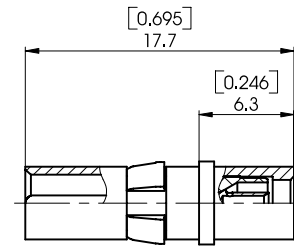
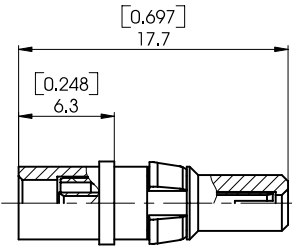

Order Number Plug <i>Bestellnummer Stecker</i>	Type <i>Ausführung</i>	Platings / <i>Oberflächen</i>		Wire Size <i>Kabelgröße</i>	Order Number Receptacles <i>Bestellnummer Steckdose</i>
		Mating Area <i>Steckbereich</i>	Termination Area <i>Anschlussbereich</i>		
FMV007P107K	standard	1,3 µm Au	1,3 µm Au	AWG 24	FMV007S107K

Other platings on request

Andere Oberflächen auf Anfrage

8 microinches = $\approx 0,2 \mu\text{m}$

30 microinches = $\approx 0,8 \mu\text{m}$

50 microinches = $\approx 1,3 \mu\text{m}$

200 microinches = $\approx 5 \mu\text{m}$

Tools from page 40 onwards / *Werkzeuge ab Seite 40 ff*



Pneumatic Contacts

Pneumatikkontakte



Fig. 1: Pin pneumatic contact
Abb. 1: Stift-Pneumatikkontakt



Fig. 2: Socket pneumatic contact
Abb. 2: Buchsen-Pneumatikkontakt

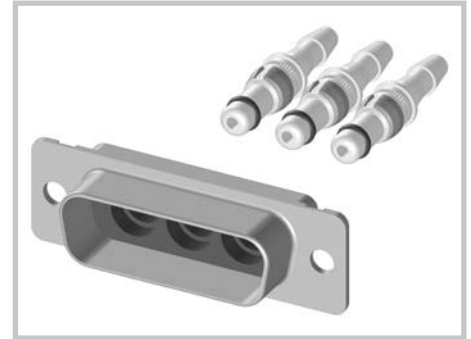

Fig. 3: Connector FM3W3P with pneumatic contacts
Abb. 3: Steckverbinder FM3W3P mit
Pneumatikkontakten

FCT pneumatic contact can be mounted in both the acclaimed D-Sub Mixed Layout as well as the DIN 41612 connector series. Should the interface be fitted with these connectors, then in addition to pneumatic, also electrical connections can be made.

The advantages are clear:

- A quick pneumatic **and** electrical connection / disconnection can be made.
- A shell connection is all that is required for the electrical and pneumatic interfaces.
- Simple pneumatic contact assembly by detaching the pneumatic tube. No extra connecting joint required.
- Multiple areas of use are created for these contacts through a wide range of FCT accessories (hoods, brackets, locking devices, etc.) available for D-Sub Mixed Layout connectors.

FCT Pneumatikkontakte können sowohl in den bewährten D-Sub Mixed Layout Steckverbinder als auch in Steckverbinder nach DIN 41612 eingesetzt werden. Wird die Schnittstelle mit diesen Steckverbindern ausgerüstet, so können neben den Druckluft- auch elektrische Leitungen angeschlossen werden. Die Vorteile liegen auf der Hand:

- *Es wird ein schnelles Schließen und Lösen der pneumatischen **und** der elektrischen Verbindung möglich.*
- *Für die Schnittstelle der elektrischen und pneumatischen Leitungen wird nur noch eine Durchführung am Gehäuse benötigt.*
- *Einfache Verbindung der Druckluftkontakte durch Aufstecken der Pressluftschläuche ohne zusätzliche Verbinder.*
- *Die reichhaltige Palette an FCT Zubehör für die D-Sub Mixed Layout Steckverbinder (Winkel, Hauben, Verriegelungssysteme, etc.) bietet eine Vielzahl von Anwendungsmöglichkeiten.*



The connector and mating connector must be bolted together.
Steck- und Gegensteckverbinder müssen miteinander verschraubt sein.

Technical Data

Technische Daten

	Technical Data <i>Technische Daten</i>
Material, contact <i>Material, Kontakt</i>	German silver <i>Neusilber</i>
Material, o-ring <i>Material, O-Ring</i>	VITON
Max. pressure (68 °F) <i>Max. Druck (20 °C)</i>	101,5 psi. <i>7 bar</i>
Temperature range <i>Temperaturbereich</i>	-10 °C bis 60 °C (14 °F to 140 °F)



Dimensions

Abmessungen

Straight Pneumatic Contacts

Gerade Druckluftkontakte

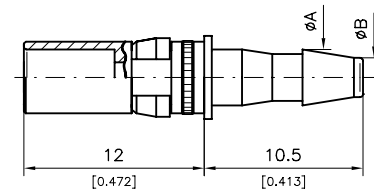
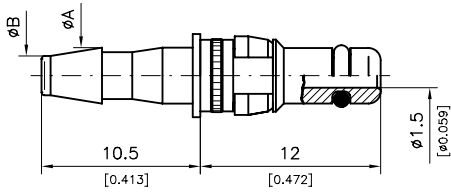

Order No. Plug <i>Bestellnummer Stecker</i>	Tube Inner Diameter <i>Schlauchinnendurchmesser</i>	ϕA	ϕB	Suitable Compressed Air Tube <i>Verwendbare Schläuche</i>	Order Number Receptacle <i>Bestellnummer Steckdose</i>
FMG002P149KR	2 (0.079)	2,6 (0.102)	1,5 (0.059)	PU-2	FMG002S149KR
FMG001P149KR	2,6 (0.102)	3,1 (0.122)	2 (0.079)	PUN-4 * 2,5	FMG001S149KR
FMG003P149KR	3 (0.118)	3,4 (0.134)	2,3 (0.091)	PU-3	FMG003S149KR
FMG004P149KR	4 (0.157)	4,8 (0.189)	3,7 (0.146)	PU-4	FMG004S149KR

Right Angled Pneumatic Contacts

Abgewinkelte Druckluftkontakte

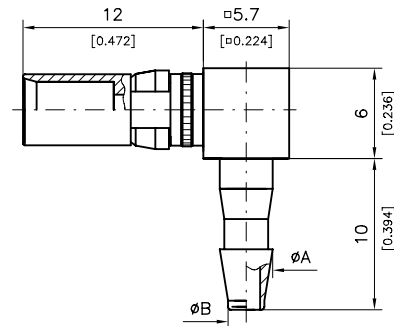
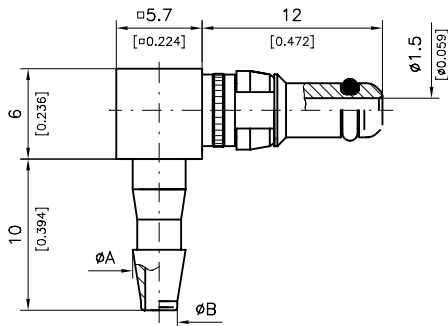

Order No. Plug <i>Bestellnummer Stecker</i>	Tube Inner Diameter <i>Schlauchinnendurchmesser</i>	ϕA	ϕB	Suitable Compressed Air Tube <i>Verwendbare Schläuche</i>	Order Number Receptacle <i>Bestellnummer Steckdose</i>
FMG006P149KR	2 (0.079)	2,6 (0.102)	1,5 (0.059)	PU-2	FMG006S149KR
FMG007P149KR	3 (0.118)	3,4 (0.134)	2,3 (0.091)	PU-3	FMG007S149KR



Special Series

Sondervarianten

We deliver all D-Sub mixed layout connectors with various accessories and contacts ready mounted on request.

Wir liefern alle Mixed Layout D-Sub Steckverbinder nach Kundenwunsch mit verschiedenen Anbauteilen und Kontakteinsätzen fertig montiert.

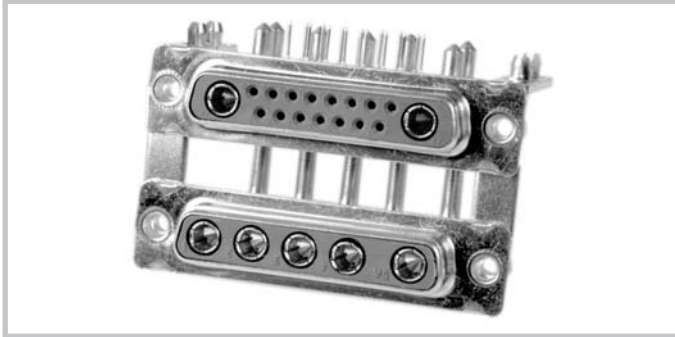

Dualport with Mixed Layout contact arrangement and mounted clinch nuts 4-40 UNC, fixed with high power contacts,

Connector 1: pin connector, contact arrangement **5W5**

Connector 2: pin connector, contact arrangement **17W2**

Dualport mit Mixed Layout Polbildern mit montierten Einnietmuttern 4-40 UNC, bestückt mit Hochstromkontakten,

*Steckverbinder 1: Stiftsteckverbinder, Polbild **5W5***

*Steckverbinder 2: Stiftsteckverbinder, Polbild **17W2***

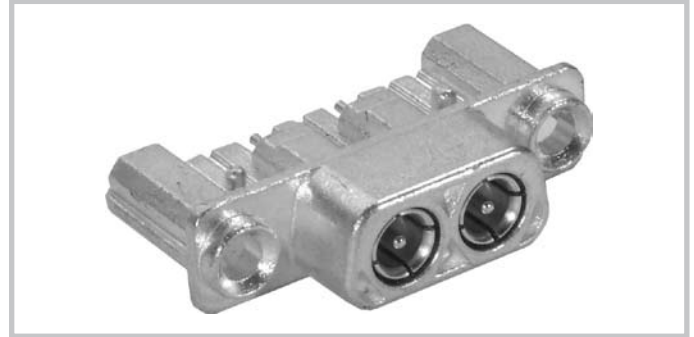

Contact arrangement **2W2**, loaded with integrated straight coax socket contacts. *Polbild **2W2**, bestückt mit integrierten geraden Koaxialbuchsenkontakten.*

Mixed Layout Connectors in Waterproof Version (IP67)

Mixed Layout Steckverbinder in wasserdichter Ausführung (IP67)



Contact arrangement **7W2**, pin connector loaded with straight power contacts in waterproofed version (IP67) for rear mounting.

*Polbild **7W2**, Stiftsteckverbinder bestückt mit geraden Hochstromkontakten in wasserdichter Ausführung (IP67) für rückseitige Montage.*

Mixed layout connectors in a waterproof design are now available at FCT electronic.

Characteristics:

- Waterproof in accordance with IP67
- Available in varying connector sizes for both front and reverse mating, as a pin or socket connector. (Please check availability)
- Can be mounted with coaxial, high power and high voltage contacts (Please check availability).
- Available with straight and right-angled signal contacts for pcb as well as solder terminations.
- Insulators and "O" rings are flame resistant in accordance with UL94V-0
- Solid and rust retardant due to zinc die-cast watertight frames.

Ab sofort sind bei FCT electronic Mixed Layout Steckverbinder in wasserdichter Ausführung erhältlich.

Merkmale:

- *Wasserdicht nach IP67*
- *In verschiedenen Polbildern für front- bzw. rückseitige Montage als Stift- bzw. Buchsensteckverbinder erhältlich. (Verfügbarkeit bitte anfragen)*
- *Bestückbar mit Koaxial-, Hochstrom- und Hochspannungskontakten (Verfügbarkeit bitte anfragen).*
- *Mit geraden und abgewinkelten Signalkontakten (Leiterplattenanschluss), sowie Löttopfanschluss erhältlich*
- *Isolierkörper und O-Ring selbstverlöschend nach UL94V-0*
- *Stabil und nichtrostend durch Dichtrahmen aus Zinkdruckguss.*



Mixed Layout Connectors in Waterproof Version (IP67)

Mixed Layout Steckverbinder in wasserdichter Ausführung (IP67)

Test report

Testbericht

As leading manufacturer of D-Sub Miniature connectors the FCT group can supply you with waterproof plastic hoods suitable for all shell sizes (1-5, 9-50 way) and for various types (e.g. High Density (HD) and Mixed Layout). Endurance tests, which are carried out internally, prove the robustness of our waterproof plastic hoods. These tests include constantly changing temperature cycles (-25 °C to +75 °C, -13 °F to +158 °F) and steam impact up to 100 bar (Kärcher HDS 558 ECO).

Testobject:
waterproof hood FWAF1GAE, waterproof connector FWDF09S-K413

Results:
After dismounting of device under test there couldn't be detected any water, neither in the assembly nor in the diagnostic mask.

Summary:
The used device under test fulfil the specifications of protection class IP69K, DIN 40050.

Als einer der führenden Hersteller von D-Sub Miniatur-Steckverbindern können wir Ihnen ab sofort für alle D-Sub-Baugrößen (1-5, 9pol.- 50pol.) und verschiedene Baureihen (z.B. High Density und Mixed Layout) auch wasserdichte Kunststoffhauben anbieten.

Intern durchgeführte Langzeittests mit ständig wechselnden Temperaturzyklen (-25 °C bis +75 °C, -13 °F bis +158 °F) und Dampfstrahleinwirkung bis 100 bar (Kärcher HDS 558 ECO) haben die Robustheit der wasserdichten Kunststoffhauben bewiesen.

Testobjekt:
wasserdichte Haube FWAF1GAE, wasserdichter Steckverbinder FWDF09S-K413

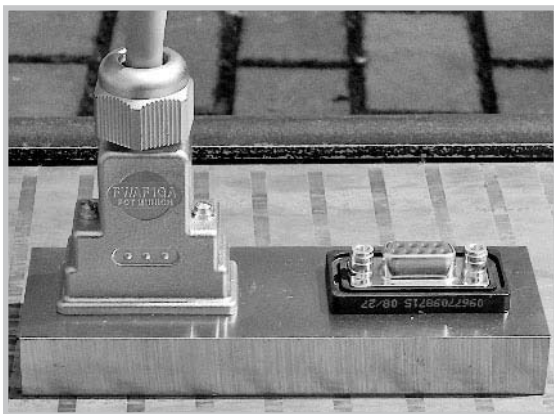

Ergebnisse:
Nach der Demontage der Prüflinge konnte weder in den Bauteilen noch in der Prüfmaske Feuchtigkeit festgestellt werden.

Zusammenfassung:
Die verwendeten Prüflinge erfüllen unter den zu Grunde gelegten Bedingungen die Anforderungen nach Schutzart IP69K, DIN 40050.

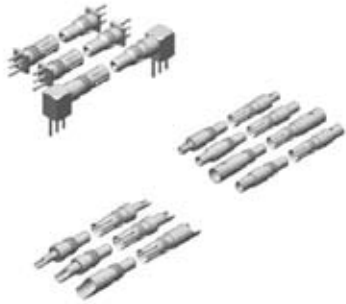

Overview Nonmagnetic Products

Übersicht nonmagnetische Produkte

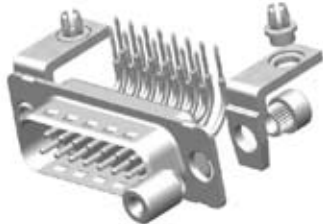
		
<p>Connectors <i>Steckverbinder</i></p>	<p>Permeability $\leq 1,0025$ <i>Permeabilität $\leq 1,0025$</i></p>	<p>Contacts <i>Kontakte</i></p>
		
<p>Hoods <i>Hauben</i></p>	<p>100% tested <i>100% geprüft</i></p>	<p>Accessories <i>Zubehör</i></p>
		



General Information on Crimp Connections

Allgemeine Informationen über Crimpverbindungen

Features

Merkmale

Compared to conventional soldering, crimping has many advantages. It is not surprising that crimping is used extensively in the aerospace industry where reliability is essential. Crimping ensures that connections are more durable and reliable than with soldering; crimping is also quicker and more economical to carry out.

Im Vergleich zu konventionellen Lötverbindungen bietet die Technik des Crimpens zahlreiche überzeugende Vorteile. Nicht umsonst wird gerade in der Luft- und Raumfahrt, wo es auf Zuverlässigkeit ankommt, fast ausschließlich gecrimpt. Mit dieser Technik werden Verbindungen hergestellt, die nicht nur dauerhafter und zuverlässiger sind als Lötstellen; mit ihr kann auch schneller und wirtschaftlicher gearbeitet werden.

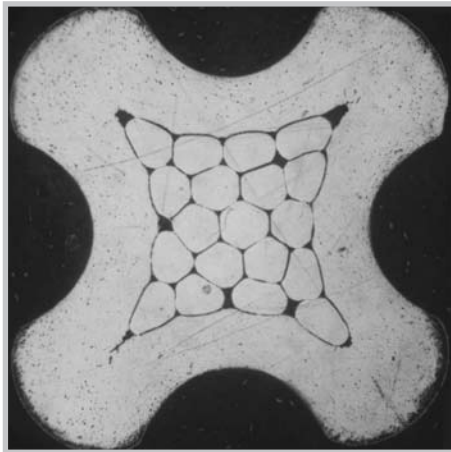

Fig. 1: Correct crimp termination
Abb. 1: Gute Crimpung

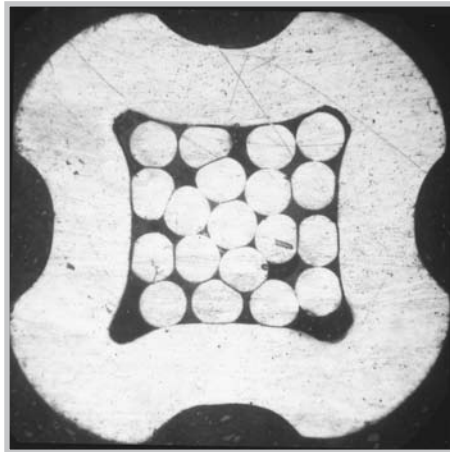

Fig. 2: Undercrimped
Abb. 2: Nicht ausreichend gecrimpt

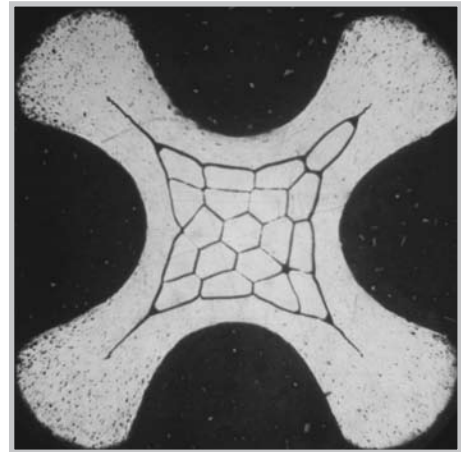

Fig. 3: Overcrimped
Abb. 3: Übercrimpt

Although a solder joint may appear to be perfect, a connection could fail as a result of a structural defect. For example, signs of corrosion may occur as a result of the use of flux or worse still, the solder joint may not be completely covered due to material incompatibility. In addition to other problems, such as not allowing sufficient solder time, solder quality depends largely upon the ability of the person who is soldering. The quality of solder joints cannot however be easily checked. This is not the case with crimping. Precision tools continually guarantee good results. In addition, different materials can be processed irrespective of their finish or thermal properties.

Hand crimping tools do not require a mains electricity supply. Crimping can be carried out in almost half the time of soldering and allows the removal of defective contacts. The finished product can be inspected through an inspection hole. Crimp connections have proved to withstand vibrations and separational forces better than solder connections. In order to achieve the best results e.g. in accordance with MIL specifications, it is essential that contacts, cable and tools are designed to fit one another. FCT offers a wide range for nearly all applications - please ask us!

Lötstellen können optisch einwandfrei aussehen, während in ihrem Gefüge bereits der Ausfall der Verbindung vorprogrammiert ist. So kann es z. B. zu Korrosionserscheinungen durch das verwendete Flussmittel kommen oder, schlimmer noch, die Lötstelle ist wegen Materialunverträglichkeiten nicht richtig benetzt. Neben den thermischen Problemen (zu kurze Lötzeit) ist eine einwandfreie Lötung sehr vom Können des Verarbeiters abhängig und schlecht zu kontrollieren. Nicht so beim Crimpen. Präzises Werkzeug garantiert immer gleich gute Ergebnisse. Auch lassen sich verschiedene Materialien ohne Einfluss der Oberflächen und ohne thermische Beanspruchung einwandfrei verarbeiten. Außer der Unabhängigkeit von einer Steckdose bietet das Crimpen eine bis zu 50 % kürzere Montagezeit und ermöglicht auch die Reparatur beschädigter Kontakte. Durch eine Prüfbohrung kann die fertige Verbindung kontrolliert werden. Crimpverbindungen erweisen sich darüber hinaus als sehr standfest gegenüber Vibrationen und bieten höhere Auszugskräfte als entsprechende Lötverbindungen. Um optimale Ergebnisse zu erzielen (z. B. MIL - Anforderungen), ist es unabdingbar, dass Kontakte, Kabel und Werkzeug aufeinander abgestimmt sind. FCT bietet eine umfangreiche Auswahl für nahezu alle Anwendungsfälle - fragen Sie uns!



Processing

Verarbeitung

1. Strip the wire.
Kabel abisolieren.



2. Attach the sleeve and inner conductor.
Crimphülse und Kontaktinnenleiter aufstecken.



3. Crimp the inner conductor.
Innenleiter ancrimpen.



4. Snap the inner conductor into the contact.
Innenleiter in Kontakt einrasten.



5. Add the insulation braiding.
Schirmgeflecht anlegen.



6. Slide the sleeve forwards and crimp.
Hülse vorschieben und ancrimpen.



Crimping the inner conductor with hand cimp tool **M22520/2-01**.
Crimpfung des Innenleiters mit der Handcrimpzange M22520/2-01.



Crimping the outer conductor with hand cimp tool **M22520/5-01**.
Crimpfung des Außenleiters mit der Handcrimpzange M22520/5-01.



Tools

Werkzeuge

Crimping Tools for Coaxial Contacts without Crimp Snap-in

Crimpwerkzeuge für Koaxialkontakte ohne Crimp Snap-In

Hand Crimp Tool <i>Handcrimpzange</i>	Pneumatic Crimp Tool <i>Pneumatisches Crimpwerkzeug</i>	Outer Conductor / <i>Außenleiter</i>		
		Die <i>Werkzeugeinsatz</i>	Cavity <i>Einsatzkammer</i>	Contact Part No. <i>Kontaktart</i>
M22520/5-01	PH4001 PH4002*	Y1535P	C	FMX005...
		Y1535P	B	FMX006...
		Y1535P	A	FMX007...
		Y197P	A	FMX008...
		Y138P	B	FMX012...
		Y1535P	B	FMX029...
		Y1535P	C	FMX031...
		Y138P	B	FMX032...
		Y1535P	B	FMX002...
		Y1535P	B	FMX003...

* same as PH4001, but with foot release

* wie PH4001, jedoch mit Fußauslöser

Crimping Tools for Coaxial Contacts with Crimp Snap-in

Crimpwerkzeuge für Koaxialkontakte mit Crimp Snap-In

Outer Conductor

Außenleiter

Hand Crimp Tool <i>Handcrimpzange</i>	Pneumatic Crimp Tool <i>Pneumatisches Crimpwerkzeug</i>	Outer Conductor / <i>Außenleiter</i>		
		Die <i>Werkzeugeinsatz</i>	Cavity <i>Einsatzkammer</i>	Contact Part No. <i>Kontaktart</i>
M22520/5-01	PH4001 PH4002*	Y1535P	B	FMS001...
		Y1535P	B	FMS002...
		Y1535P	A	FMS003...
		Y138P	B	FMS006...
		Y197P	A	FMS009...
		Y1535P	B	FMS012...
		Y138P	B	FMS022...
		Y197P	A	FMS026...
		Y1535P	B	FMS015...

* same as PH4001, but with foot release

* wie PH4001, jedoch mit Fußauslöser

Inner Conductor

Innenleiter

Hand Crimp Tool <i>Handcrimpzange</i>	Pneumatic Crimp Tool <i>Pneumatisches Crimpwerkzeug</i>	Inner Conductor / <i>Innenleiter</i>				
		Positioner <i>Werkzeugeinsatz</i>	Selector Position <i>Selektoreinstellung</i>			
M22520/2-01	WA22	K1003	Cable size (AWG) <i>Kabelgröße (AWG)</i>			
			24	26	28	30
			SEL			
			5	5	4	3
			FMS001...			
		FMS002...				
		FMS003...				
		FMS006...				
		FMS009...				
		FMS010...				
FMS012...						
FMS015...						
FMS022...						
FMS026...						



Crimping Tools for Wiresplice

Crimpwerkzeuge für Wiresplice

Outer Conductor

Außenleiter

Outer Conductor / <i>Außenleiter</i>				
Hand Crimp Tool <i>Handcrimpzange</i>	Pneumatic Crimp Tool <i>Pneumatisches Crimpwerkzeug</i>	Die <i>Werkzeugeinsatz</i>	Cavity <i>Einsatzkammer</i>	Contact Part No. <i>Kontaktart</i>
M22520/5-01	PH4001 PH4002*	Y1535P	B	FMS010...
		Y138P	B	FMS028...
		Y1535P	A	FMS029...
		Y197P	A	FMS030...

* same as PH4001, but with foot release

* wie PH4001, jedoch mit Fußauslöser

Inner Conductor

Innenleiter

Inner Conductor / <i>Innenleiter</i>							
Hand Crimp Tool <i>Handcrimpzange</i>	Pneumatic Crimp Tool <i>Pneumatisches Crimpwerkzeug</i>	Positioner <i>Werkzeugeinsatz</i>	Selector Position <i>Selektoreinstellung</i>		Contact Part No. <i>Kontaktart</i>		
M22520/2-01	WA22	K1003	Cable size (AWG) <i>Kabelgröße (AWG)</i>		FMS010...		
			24	26	28	30	FMS028...
			SEL	5	5	4	3
					FMS030...		

Crimping Tools for High Power Contacts

Crimpwerkzeuge für Hochstromkontakte

Hand Crimp Tool <i>Handcrimpzange</i>	Pneumatic Crimp Tool <i>Pneumatisches Crimpwerkzeug</i>	Positioner <i>Werkzeugeinsatz</i>	
		For Plugs <i>für Stecker</i>	For Receptacles <i>für Steckdosen</i>
M309	WA27-309-2C	TP1071-1	TP1072-1
		SP994	



Crimping Tools

Crimpwerkzeuge



Hand crimp tool for coaxial contacts (outer conductor).
Tool order number: M22520/5-01

Handcrimpzange zum Crimpen von Koaxialkontakten (Außenleiter).
Werkzeugbestellnummer: M22520/5-01



Pneumatic crimp tool for coaxial contacts (outer conductor).
Tool order number: PH4001
 PH4002 (with foot release)

Pneumatisches Werkzeug zum Crimpen von Koaxialkontakten (Außenleiter).
Werkzeugbestellnummer: PH4001
 PH4002 (mit Fußauslöser)

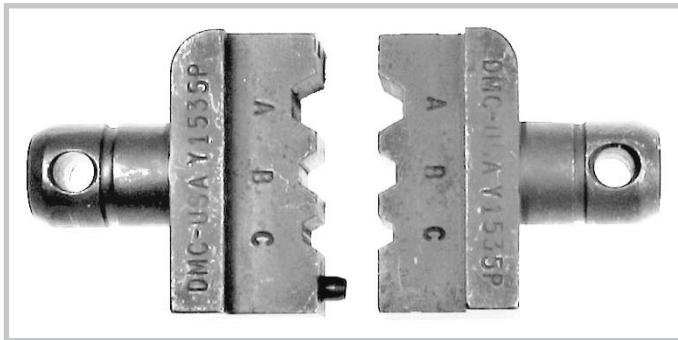

Crimp die.
Order number: Y1535P

Einsatz für Crimpwerkzeuge.
Bestellnummer: Y1535P



Hand crimp tool for coaxial contacts (inner conductor).
Tool order number: M22520/2-01

Handcrimpzange zum Crimpen von Koaxialkontakten (Innenleiter).
Werkzeugbestellnummer: M22520/2-01



Hand crimp tool for high power contacts.
Tool order number: M309
 Positioner for plug: TP1071-1
 Positioner for receptacles: TP1072-1
 Positioner for plugs and receptacles: SP994

Handcrimpzange zum Crimpen von Hochstromkontakten.
Werkzeugbestellnummer: M309
 Einsatz für Stecker: TP1071-1
 Einsatz für Steckdosen: TP1072-1
 Einsatz für Stecker und Steckdosen: SP994



Crimping tool / Crimpwerkzeug WA27-309-2C
 Tool / Einsatz SP994
 Bench mount / Standsoclel / BM2
 Foot release / Fußauslöser F-3-1/4B
Tool order number: WA27-309-2C with foot release
 BM-2 (bench mount)
 SP994 (positioner)
 TP1071-1, TP1072-1 (positioner)

Pneumatisches Werkzeug zum Crimpen von Hochstromkontakten.
Werkzeugbestellnummer: WA27-309-2C mit Fußauslöser
 BM-2 (Standsocket)
 SP994 (Werkzeugeinsatz)
 TP1071-1, TP1072-1 (Werkzeugeinsatz)



Insertion and Extraction Tools

Ein- und Ausbauwerkzeug

General Information

Allgemeine Informationen

Connectors with removable contacts facilitate repairs to a connection e.g. in the case of a damaged cable.

The insertion of contacts during assembly or replacement during repair is quick and easy with the appropriate tools. The tools must fit the contacts and the connectors, if assembly and repair are to be carried out correctly. For almost every type of application FCT offers a solution – Please ask us!

Steckverbinder mit ein- und ausbaubaren Kontakten bieten die Möglichkeit der Reparatur einer Verbindung z. B. bei beschädigter Leitung.

Das Einsetzen bei der Montage bzw. der Austausch bei einem Reparaturfall ist mit dem dafür vorgesehenen Werkzeug einfach und problemlos möglich. Steckverbinder, Kontakt und Werkzeug müssen aufeinander abgestimmt sein, wenn die Montage wirklich zuverlässig ausgeführt werden soll. FCT bietet für nahezu jeden Anwendungsfall eine Lösung – fragen Sie uns!



Extraction Tool

Ausbauwerkzeug

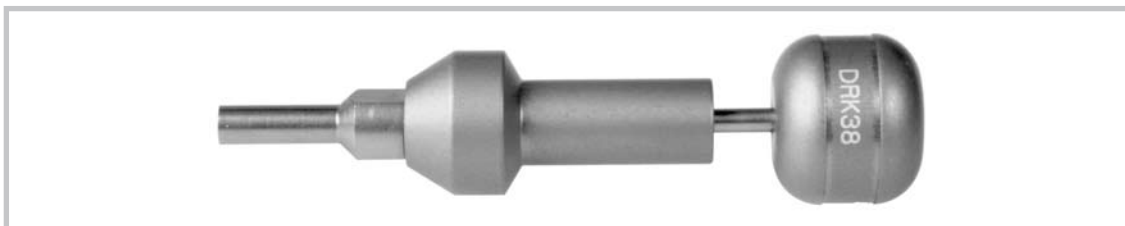

For coaxial-, high voltage-, high power- and pneumatic contacts.
Für Koaxial-, Hochspannungs-, Hochstrom- und Druckluftkontakte.

Order number: DRK38
Bestellnummer: DRK38

Plastic Insertion and Extraction Tool

Ein- und Ausbauwerkzeug aus Kunststoff

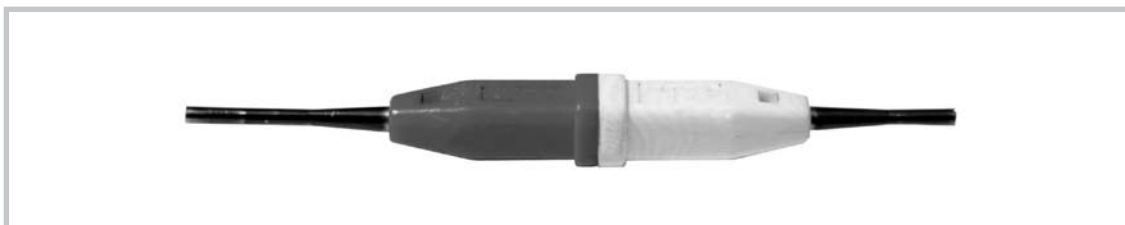

For signal contacts in the FU- or FL-series (Size AWG 20).
Für Signalkontakte der FU- bzw. FL-Baureihe (Größe AWG 20).

Order number: M81969/1-02
Bestellnummer: M81969/1-02

Metal Insertion and Extraction Tool

Ein- und Ausbauwerkzeug aus Metall



For signal contacts in the FU- or FL-series (Size AWG 20).
Für Signalkontakte der FU- bzw. FL-Baureihe (Größe AWG 20).

Order number: Insertion tool: DAK273 Extraction tool: DRK273
Bestellnummer: Einbauwerkzeug: DAK273 Ausbauwerkzeug: DRK273



Accessories

Zubehör

Sealing Plugs

Blindstopfen

Sealing plugs are mounted from the front on all pin and socket connectors. *Die Blindstopfen werden bei allen Stift- und Buchsensteckverbindern frontseitig montiert.*

Colour Sealing Plug <i>Farbe Blindstopfen</i>	Order Number <i>Bestellnummer</i>
red / <i>rot</i>	F80K012R
black / <i>schwarz</i>	F80K012S
blue / <i>blau</i>	F80K012B
green / <i>grün</i>	F80K012G
yellow / <i>gelb</i>	F80K012Y



Guide Pins

Zentrierstifte

Our guide pin systems guarantee blind insertion in tight spaces. We provide two different assemblies. Guide pins and funnels mounted on the connector shell or panel, or guide pins placed in contact cavities. In the second alternative the corresponding contact cavities of the socket connector are used to receive the guide pins. **The guide pins are only delivered completely mounted in the connector.**

*Unsere Führungsstiftsysteme gewährleisten ein blindes Stecken unter engen Platzverhältnissen. Dazu bieten wir zwei unterschiedliche Montagemöglichkeiten an. Zentrierstifte und Aufnahmen die am Steckverbindergehäuse bzw. am Paneel montiert werden oder Zentrierstifte die in Sonderkontaktkammern der Stiftsteckverbinder eingebracht werden. Bei zweiter Variante bleiben die korrespondierenden Kontaktkammern des Buchsensteckverbinders leer und dienen zur Zentrierstiftaufnahme. **Die Zentrierstifte werden nur komplett im Steckverbinder montiert geliefert.***



Ordering Example

Bestellbeispiel

Mixed layout pin connector, straight PCB termination, contact arrangement 17W2, 15 signal contacts P1, 2 guide pins, accessories according to the modification number

FM17W2P1-0627

Mixed Layout Stiftsteckverbinder, gerader Leiterplattenanschluss, Polbild 17W2, 15 Signalkontakte P1, 2 Zentrierstifte, Anbauteile entsprechend Modifikationsnummer:

FM17W2P1-0627



Guide Pins

Zentrierstifte

Guide Pins for Connector Shell Assembly

Zentrierstifte zur Montage am Steckverbindergehäuse

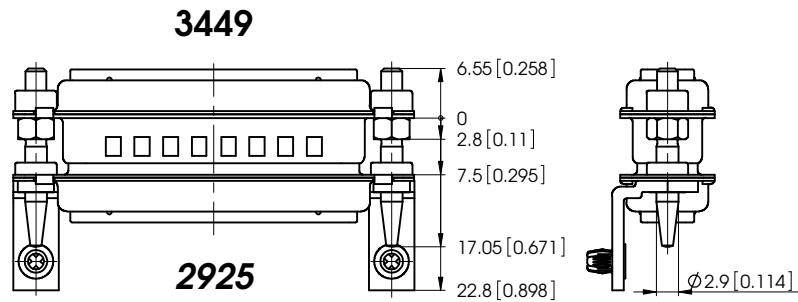
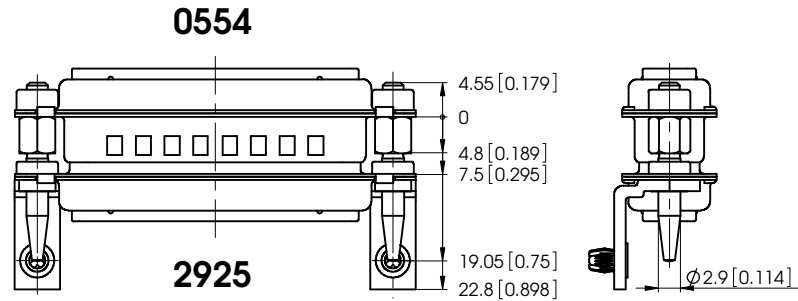

Metal Guide Pins for Contact Cavity Assembly

Metallzentrierstifte zur Montage in Sonderkontaktkammern

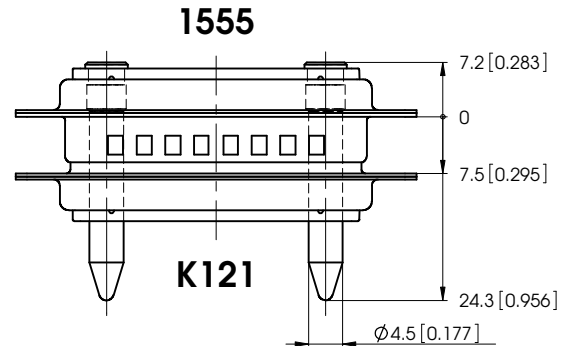
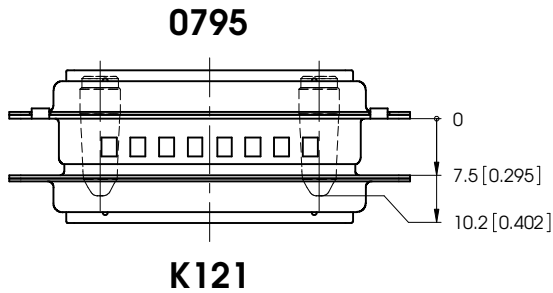

Plastic Guide Pins for Contact Cavity Assembly

Kunststoffzentrierstifte zur Montage in Sonderkontaktkammern

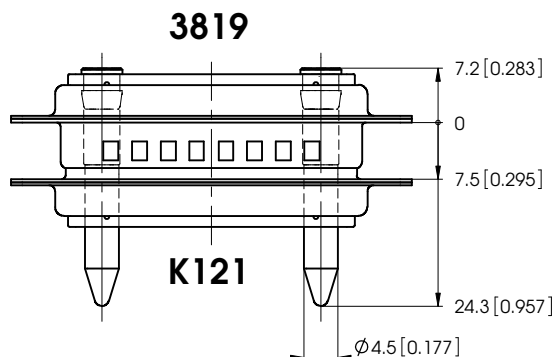



General Information on the Construction of Mixed Layout Connectors

Allgemeine Informationen zum Aufbau Mixed Layout Steckverbinder

FM Series

Baureihe FM

Coaxial contacts

with various types of terminations from page 26 onwards.

Koaxialkontakte

mit verschiedenen Anschlussarten ab Seite 26.

Available contact arrangements

see page 11.

Lieferbare Polbilder

ab Seite 11.

Accessories

see our "D-Sub Miniature Connectors" catalogue.

Zubehör

im Katalog "D-Sub Miniatur Steckverbinder"

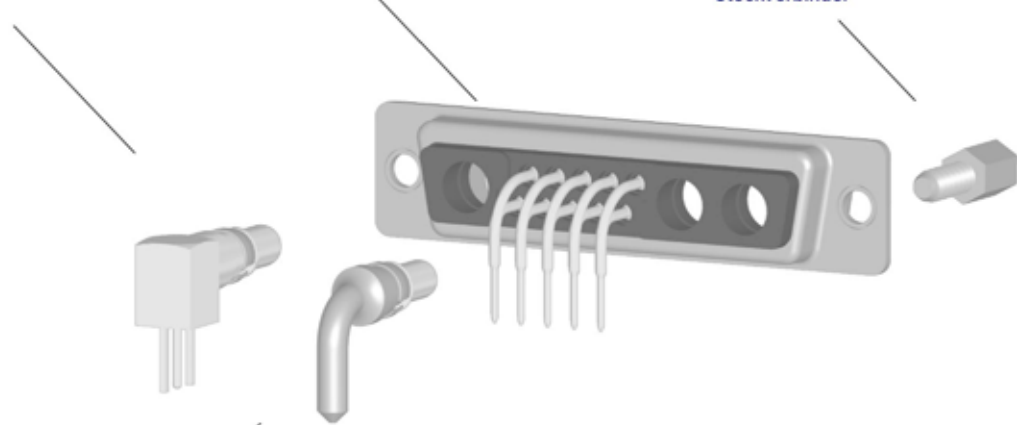

High power contacts

including crimp terminations see page 64.

Hochstromkontakte

auch crimpbar ab Seite 64.

FM Series:

With fixed signal contacts; For terminations see page 18.

Baureihe FM:

Mit fest eingebauten Signalkontakten; Anschlussarten ab Seite 18.

FU / FL Series

Baureihe FU / FL

High voltage contacts

see page 84.

Hochspannungskontakte

ab Seite 84.

Available contact arrangements

see page 12.

Lieferbare Polbilder

ab Seite 12.

Accessories

See our catalogue

"D-Sub Miniature Connectors".

Zubehör

in unserem Katalog "D-Sub Miniatur Steckverbinder".

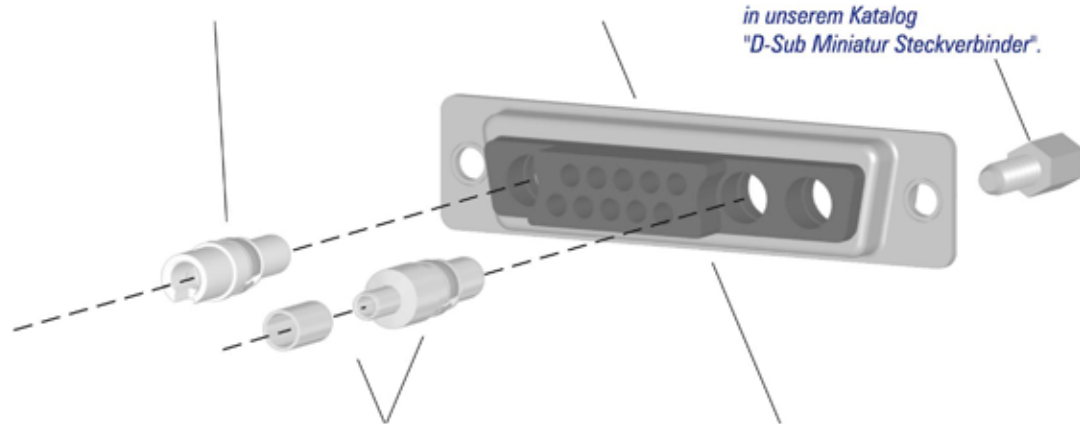

Coaxial contacts

with crimp inner conductor see page 34.

Koaxialkontakte

auch mit crimpbarem Innenleiter ab Seite 34.

FU Series:

Insulator for insertion / extraction signal contacts, see page 22.

Baureihe FU:

Isolierkörper für ein- und ausbaubare Signalkontakte mit Crimpanschluss, ab Seite 22.



Order Number Index

Bestellnummernindex

13W6	12	FK20SL-02V...	24	FME002P102	46
2761	24	FK20SL-08V...	24	FME002P108	46
27W2	12	FK20SL18-02V...	24	FME002P201	46
27W7	12	FK20SL26-02V...	24	FME002P202	46
43W2	12	FL11W1	12	FME002S101	46
47W1	12	FL13W3	12	FME002S102	46
5W1	12	FL13W3P7-K120	22	FME002S108	46
9W4	12	FL17W2	12	FME002S201	46
		FL17W5	12	FME002S202	46
B		FL21W1	12	FME005P101	44
BM-2	96	FL21W4A	12	FME005P102	44
		FL25W3	12	FME005P108	44
D		FL36W4	12	FME005P201	44
DAK273	97	FL7W2	12	FME005P202	44
DRK273	97	FM11W1	11	FME005S101	44
DRK38	97	FM13W3	11	FME005S102	44
		FM13W3P1-K120	14	FME005S108	44
F		FM13W3P5-K629	2	FME005S201	44
F1W1	11	FM13W6	11	FME005S202	44
F2W2...C	11	FM17W2	11	FME008P101	42
F3W3...C	11	FM17W5	11	FME008P102	2,42
F7W7	11	FM21W1	11	FME008P108	42
F80K012B	98	FM21W4A	11	FME008P201	42
F80K012G	98	FM24W7	11	FME008P202	42
F80K012R	98	FM25W3	11	FME008S101	42
F80K012S	98	FM27W2	11	FME008S102	42
F80K012Y	98	FM36W4	11	FME008S108	42
FBM001P154MR	63	FM3W3	11	FME008S201	42
FBM001S154UR	63	FM43W2	11	FME008S202	42
FBM002P154M	59	FM47W1	11	FME009P101	43
FBM002S154U	59	FM5W1	11	FME009P102	43
FBM003P154M	59	FM5W5	11	FME009P108	43
FBM003S154U	59	FM7W2	11	FME009P201	43
FBM004P154M	60	FM8W8	11	FME009P202	43
FBM004S154U	60	FM8W8P	10	FME009S101	43
FBM005P154M	60	FM8W8S	10	FME009S102	43
FBM005S154U	60	FM9W4	11	FME009S108	43
FBM006P154MR	61	FMA026P103	71	FME009S201	43
FBM006S154UR	61	FMA026P105	71	FME009S202	43
FBM007P154MR	62	FMA026P203	71	FME010P101	41
FBM007S154UR	62	FMA026S103	71	FME010P102	41
FK20P	24	FMA026S105	71	FME010P108	41
FK20P-13V...	24	FMA026S203	71	FME010S101	41
FK20P26-13V...	24	FME001P101	45	FME010S102	41
FK20PL	24	FME001P102	45	FME010S108	41
FK20PL-02V...	24	FME001P108	45	FME018P101	45
FK20PL-08V...	24	FME001P201	45	FME018P102	45
FK20PL18-02V...	24	FME001P202	45	FME018P108	45
FK20PL26-02V...	24	FME001S101	45	FME018S101	45
FK20S	24	FME001S102	45	FME018S102	45
FK20S-13V...	24	FME001S108	45	FME018S108	45
FK20S26-13V...	24	FME001S201	45	FME020P101	42
FK20SL	24	FME001S202	45	FME020P102	42
		FME002P101	46	FME020P108	42

Order Number Index

Bestellnummernindex

FME020S101	42	FMP009S104	69	FMS002S101	36
FME020S102	42	FMP009S105	69	FMS002S102	36
FME020S108	42	FMP010P104	68	FMS002S201	36
FMG001P149KR	88	FMP010P105	68	FMS002S202	36
FMG001S149KR	88	FMP010P203	68	FMS003P101	36
FMG002P149KR	88	FMP010S104	68	FMS003P102	36
FMG002S149KR	88	FMP010S105	68	FMS003S101	36
FMG003P149KR	88	FMP010S203	68	FMS003S102	36
FMG003S149KR	88	FMP014P104	68	FMS006P101	34
FMG004P149KR	88	FMP014P105	68	FMS006P102	34
FMG004S149KR	88	FMP014S104	68	FMS006S101	34
FMG006P149KR	88	FMP014S105	68	FMS006S102	34
FMG006S149KR	88	FMP016P104	68	FMS009P101	34
FMG007P149KR	88	FMP016P105	68	FMS009P102	34
FMG007S149KR	88	FMP016S104	68	FMS009S101	34
FMP002P103	67	FMP016S105	68	FMS009S102	34
FMP002P106	67	FMP021P104	69	FMS010-101	40
FMP002P204	67	FMP021P105	69	FMS010-102	40
FMP002S103	67	FMP021S104	69	FMS010...	95
FMP002S106	67	FMP021S105	69	FMS012P101	35
FMP002S204	67	FMP053P103	67	FMS012P102	35
FMP003P103	67	FMP053P106	67	FMS012P201	35
FMP003P106	67	FMP053S103	67	FMS012P202	35
FMP003S103	67	FMP053S106	67	FMS012S101	35
FMP003S106	67	FMP062P104	69	FMS012S102	35
FMP004P103	67	FMP062P105	69	FMS015P101	37
FMP004P106	67	FMP062S104	69	FMS015P102	37
FMP004S103	67	FMP062S105	69	FMS015P201	37
FMP004S106	67	FMP094P140	70	FMS015P202	37
FMP005P103	66	FMP094P141	70	FMS015S101	37
FMP005P105	66	FMP094S140	70	FMS015S102	37
FMP005P203	66	FMP094S141	70	FMS015S201	37
FMP005P204	66	FMP105P103	66	FMS015S202	37
FMP005S103	66	FMP105P105	66	FMS016P101	39
FMP005S105	66	FMP105S103	66	FMS016P102	39
FMP005S203	66	FMP105S105	66	FMS016P201	39
FMP005S204	66	FMP133P140	71	FMS016P202	39
FMP006P103	66	FMP133P141	71	FMS016S101	39
FMP006P105	66	FMP133S140	71	FMS016S102	39
FMP006S103	66	FMP133S141	71	FMS016S201	39
FMP006S105	66	FMP235P104	69	FMS016S202	39
FMP007P103	66	FMP235S104	69	FMS022P101	35
FMP007P105	66	FMP334P104IR	72	FMS022P102	35
FMP007S103	66	FMP334S104IR	72	FMS022S101	35
FMP007S105	66	FMS001P101	34	FMS022S102	35
FMP008P102	2	FMS001P102	34	FMS026P101	35
FMP008P104	2,69	FMS001P201	34	FMS026P102	35
FMP008P105	69	FMS001P202	34	FMS026S101	35
FMP008P203	69	FMS001S101	34	FMS026S102	35
FMP008S104	69	FMS001S102	34	FMS028-101	40
FMP008S105	69	FMS001S201	34	FMS028-102	40
FMP008S203	69	FMS001S202	34	FMS028...	95
FMP009P104	69	FMS002P101	36	FMS029-101	40
FMP009P105	69	FMS002P102	36	FMS029-102	40



Order Number Index

Bestellnummernindex

FMS029...	95	FMX031P102	32	Y	
FMS030-101	40	FMX031S101	32	Y138P	94,95
FMS030-102	40	FMX031S102	32	Y1535P	94,95,96
FMS030...	95	FMX032P101	32	Y197P	94,95
FMT17W2P	13	FMX032P102	32		
FMV001P107K	85	FMX032S101	32		
FMV001S107K	85	FMX032S102	32		
FMV002P107K	85	FMX058P101	39		
FMV002S107K	85	FMX058P102	39		
FMW17W2S	13	FMX058P201	39		
FMX002P101	33	FMX058P202	39		
FMX002P102	33	FMX058S101	39		
FMX002P201	33	FMX058S102	39		
FMX002P202	33	FMX058S201	39		
FMX002S101	33	FMX058S202	39		
FMX002S102	33	FU11W1	12		
FMX002S201	33	FU13W3	12		
FMX002S202	33	FU17W2	12		
FMX003P101	33	FU17W5	12		
FMX003P102	33	FU21W1	12		
FMX003S101	33	FU21W4A	12		
FMX003S102	33	FU25W3	12		
FMX005P101	31	FU36W4	12		
FMX005P102	31	FU7W2	12		
FMX005P201	31				
FMX005P202	31	K			
FMX005S101	31	K1003	94,95		
FMX005S102	31	K1092S	94,95		
FMX005S201	31				
FMX005S202	31	M			
FMX006P101	31	M22520/2-01	24,94,95,96		
FMX006P102	31	M22520/2-08	24		
FMX006S101	31	M22520/5-01	94,95,96		
FMX006S102	31	M309	95,96		
FMX007P101	31	M81969/1-02	97		
FMX007P102	31	MS002P201	36		
FMX007S101	31	MS002P202	36		
FMX007S102	31				
FMX008P101	31	P			
FMX008P102	31	PH4001	94,95,96		
FMX008S101	31	PH4002	94,95,96		
FMX008S102	31				
FMX012P101	31	S			
FMX012P102	31	SP994	95,96		
FMX012S101	31				
FMX012S102	31	T			
FMX029P101	32	TP1071-1	95,96		
FMX029P102	32	TP1072-1	95,96		
FMX029P201	32				
FMX029P202	32	W			
FMX029S101	32	WA22	94,95		
FMX029S102	32	WA27-309-2C	95,96		
FMX029S202	32				
FMX031P101	32				

**Further Catalogues or Data Sheets on the Following
Products are Available on Request**
*Zu den folgenden Produkt-Baureihen sind weitere Kataloge
oder Datenblätter erhältlich*



- D-Sub Miniature Connectors

- Inclusive:
- Accessories for D-Sub Connectors
 - Low profile D-Sub Connectors
 - D-Sub crimp Connectors
 - D-Sub IDC Connectors
 - D-Sub Dualport Connectors
 - Waterproof D-Sub Connectors Systems
 - SMT Connectors
- Hoods for D-Sub Connectors
 - High Density D-Sub Connectors
 - D-Sub Filter Connectors
 - D-Sub Mixed Layout Connectors
 - Connectors according to EN 60603-2 (previously DIN 41612), Type M, M/2, M/3
 - Coaxial, High Power and High Voltage Contacts
 - Special Tools for Connectors (M81969, M22520)
 - Bus Interface Connectors
 - Ready Made Cable / Overmoulded Cable
 - Automating Medium

- D-Sub Miniatur Steckverbinder

- Inklusive:
- Zubehör für D-Sub Steckverbinder
 - D-Sub Steckverbinder mit geringer Einbauhöhe
 - D-Sub Crimp Steckverbinder
 - D-Sub Flachbandkabelsteckverbinder
 - D-Sub Dualport Steckverbinder
 - Wasserdichtes D-Sub Steckverbindersystem
 - SMT Steckverbinder
- Hauben für D-Sub Steckverbinder
 - High Density D-Sub Steckverbinder
 - D-Sub Filter Steckverbinder
 - D-Sub Mixed Layout Steckverbinder
 - Steckverbinder nach EN 60603-2 (früher DIN 41612), Bauform M, M/2, M/3
 - Koaxial-, Hochstrom- und Hochspannungskontakte
 - Spezialwerkzeuge für Steckverbinder (M81969, M22520)
 - Bus Schnittstellen Steckverbinder
 - Konfektionierte Kabel / umspritzte Kabel
 - Automatisierungshilfsmittel

Headquarters
Hauptverwaltung

FCT electronic gmbh

Schatzbogen 33; D-81829 München; Germany
Tel.: +49 / 89 / 420004-0; Fax: +49 / 89 / 420004-110
eMail: sales@fctgroup.com; http://fctgroup.com

FCT electronics, LP

187 Commercial Blvd.; Torrington; CT 06790; USA
Phone: (860) 482-2800; Fax: (860) 482-2872
eMail: sales-usa@fctgroup.com; http://fctgroup.com

Ihr Ansprechpartner:
Your contact person is:

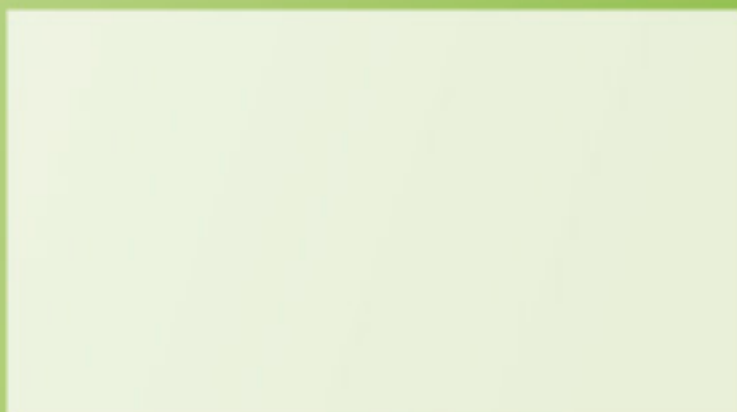

Mouser Electronics

Authorized Distributor

Click to View Pricing, Inventory, Delivery & Lifecycle Information:

[Molex:](#)

[173114-0236](#)

Компания «Life Electronics» занимается поставками электронных компонентов импортного и отечественного производства от производителей и со складов крупных дистрибьюторов Европы, Америки и Азии.

С конца 2013 года компания активно расширяет линейку поставок компонентов по направлению коаксиальный кабель, кварцевые генераторы и конденсаторы (керамические, пленочные, электролитические), за счёт заключения дистрибьюторских договоров

Мы предлагаем:

- Конкурентоспособные цены и скидки постоянным клиентам.
- Специальные условия для постоянных клиентов.
- Подбор аналогов.
- Поставку компонентов в любых объемах, удовлетворяющих вашим потребностям.
- Приемлемые сроки поставки, возможна ускоренная поставка.
- Доставку товара в любую точку России и стран СНГ.
- Комплексную поставку.
- Работу по проектам и поставку образцов.
- Формирование склада под заказчика.
- Сертификаты соответствия на поставляемую продукцию (по желанию клиента).
- Тестирование поставляемой продукции.
- Поставку компонентов, требующих военную и космическую приемку.
- Входной контроль качества.
- Наличие сертификата ISO.

В составе нашей компании организован Конструкторский отдел, призванный помогать разработчикам, и инженерам.

Конструкторский отдел помогает осуществить:

- Регистрацию проекта у производителя компонентов.
- Техническую поддержку проекта.
- Защиту от снятия компонента с производства.
- Оценку стоимости проекта по компонентам.
- Изготовление тестовой платы монтаж и пусконаладочные работы.



Тел: +7 (812) 336 43 04 (многоканальный)
Email: org@lifeelectronics.ru