

FEATURES

- On-chip oscillator as clock source**
- High accuracy, supports 50 Hz/60 Hz IEC62053-21**
- Less than 0.1% error over a dynamic range of 500 to 1**
- Supplies average real power on frequency outputs (F1, F2)**
- High frequency output (CF) calibrates and supplies instantaneous real power**
- Logic output (REVP) indicates potential miswiring or negative power**
- Direct drive for electromechanical counters and 2-phase stepper motors (F1, F2)**
- Proprietary ADCs and DSP provide high accuracy over large variations in environmental conditions and time**
- On-chip power supply monitoring**
- On-chip creep protection (no load threshold)**
- On-chip reference 2.45 V (20 ppm/°C typical) with external overdrive capability**
- Single 5 V supply, low power (20 mW typical)**
- Low cost CMOS process**

GENERAL DESCRIPTION

The AD71056¹ is a high accuracy, electrical energy metering IC with a precise oscillator circuit that serves as a clock source to the chip. The AD71056 eliminates the need for an external crystal or resonator, thus reducing the overall cost of building a meter with this IC. The chip directly interfaces with the shunt resistor.

The AD71056 specifications surpass the accuracy requirements as quoted in the IEC62053-21 standard.

The only analog circuitry used in the AD71056 is in the Σ - Δ ADCs and reference circuit. All other signal processing, such as multiplication and filtering, is carried out in the digital domain. This approach provides superior stability and accuracy over time and in extreme environmental conditions.

The AD71056 supplies average real power information on F1 and F2, the low frequency outputs. These outputs either directly drive an electromechanical counter or interface with an MCU. The high frequency CF logic output, ideal for calibration purposes, provides instantaneous real power information.

The AD71056 includes a power supply monitoring circuit on the V_{DD} supply pin. The AD71056 remains inactive until the supply voltage on V_{DD} reaches approximately 4 V. If the supply falls below 4 V, the AD71056 also remains inactive and the F1, F2, and CF outputs are in their nonactive modes.

Internal phase matching circuitry ensures that the voltage and current channels are phase matched, and the HPF in the current channel eliminates dc offsets. An internal no load threshold ensures that the AD71056 does not exhibit creep when no load is present.

The part is available in a 16-lead, narrow body SOIC package.

FUNCTIONAL BLOCK DIAGRAM

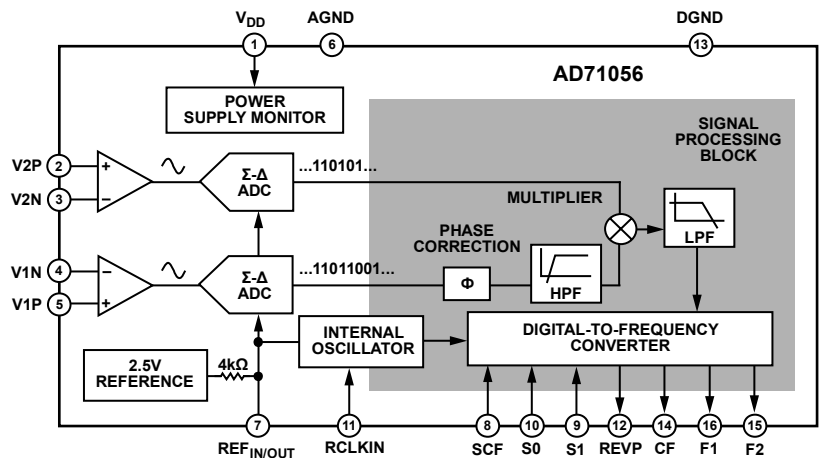

Figure 1.

¹ U.S. Patents 5,745,323; 5,760,617; 5,862,069; 5,872,469; others pending.

Rev. A

Information furnished by Analog Devices is believed to be accurate and reliable. However, no responsibility is assumed by Analog Devices for its use, nor for any infringements of patents or other rights of third parties that may result from its use. Specifications subject to change without notice. No license is granted by implication or otherwise under any patent or patent rights of Analog Devices. Trademarks and registered trademarks are the property of their respective owners.

TABLE OF CONTENTS

Features	1	Power Factor Considerations.....	10
General Description	1	Nonsinusoidal Voltage and Current.....	10
Functional Block Diagram	1	Applications.....	12
Revision History	2	Analog Inputs	12
Specifications.....	3	Power Supply Monitor	13
Timing Characteristics	4	Internal Oscillator (OSC).....	15
Absolute Maximum Ratings.....	5	Transfer Function	15
ESD Caution.....	5	Selecting a Frequency for an Energy Meter Application	16
Terminology	6	No Load Threshold	17
Pin Configuration and Function Descriptions.....	7	Negative Power Information.....	17
Typical Performance Characteristics	8	Outline Dimensions	18
Theory of Operation	10	Ordering Guide	18

REVISION HISTORY

8/06—Revision A: Initial Version

SPECIFICATIONS

$V_{DD} = 5 V \pm 5\%$, $AGND = DGND = 0 V$, on-chip reference, $R_{CLKIN} = 6.2 k\Omega$, $0.5\% \pm 50 \text{ ppm}/^\circ\text{C}$, T_{MIN} to $T_{MAX} = -40^\circ\text{C}$ to $+85^\circ\text{C}$, unless otherwise noted.

Table 1.

Parameter	Value	Unit	Test Conditions/Comments
ACCURACY^{1,2}			
Measurement Error ¹ on Channel V1	0.1	% reading typ	Channel V2 with full-scale signal ($\pm 165 \text{ mV}$), 25°C over a dynamic range 500 to 1, line frequency = 45 Hz to 65 Hz
Phase Error ¹ Between Channels			
V1 Phase Lead 37°	± 0.1	degrees max	Power factor (PF) = 0.8 capacitive
V1 Phase Lag 60°	± 0.1	degrees max	PF = 0.5 inductive
AC Power Supply Rejection ¹			
Output Frequency Variation (CF)	0.2	% reading typ	$S_0 = S_1 = 1$, $V_1 = 21.2 \text{ mV rms}$, $V_2 = 116.7 \text{ mV rms}$ @ 50 Hz, ripple on V_{DD} of 200 mV rms @ 100 Hz
DC Power Supply Rejection ¹			
Output Frequency Variation (CF)	± 0.3	% reading typ	$S_0 = S_1 = 1$, $V_1 = 21.2 \text{ mV rms}$, $V_2 = 116.7 \text{ mV rms}$, $V_{DD} = 5 V \pm 250 \text{ mV}$
ANALOG INPUTS³			
Channel V1 Maximum Signal Level	± 30	mV max	V1P and V1N to AGND
Channel V2 Maximum Signal Level	± 165	mV max	V2P and V2N to AGND
Input Impedance (DC)	320	$k\Omega$ min	OSC = 450 kHz, $R_{CLKIN} = 6.2 k\Omega$, $0.5\% \pm 50 \text{ ppm}/^\circ\text{C}$
Bandwidth (-3 dB)	7	kHz nominal	OSC = 450 kHz, $R_{CLKIN} = 6.2 k\Omega$, $0.5\% \pm 50 \text{ ppm}/^\circ\text{C}$
ADC Offset Error ^{1,2}	± 18	mV max	
Gain Error ¹	± 4	% ideal typ	External 2.5 V reference, $V_1 = 21.2 \text{ mV rms}$, $V_2 = 116.7 \text{ mV rms}$
OSCILLATOR FREQUENCY (OSC)			
Oscillator Frequency Tolerance ¹	± 12	% reading typ	$R_{CLKIN} = 6.2 k\Omega$, $0.5\% \pm 50 \text{ ppm}/^\circ\text{C}$
Oscillator Frequency Stability ¹	± 30	$\text{ppm}/^\circ\text{C}$ typ	
REFERENCE INPUT			
REF _{IN/OUT} Input Voltage Range	2.65 2.25	V max V min	2.45 V nominal 2.45 V nominal
Input Capacitance	10	pF max	
ON-CHIP REFERENCE			
Reference Error	± 200	mV max	2.45 V nominal
Temperature Coefficient	± 20	$\text{ppm}/^\circ\text{C}$ typ	
LOGIC INPUTS⁴			
SCF, S0, S1			
Input High Voltage, V_{INH}	2.4	V min	$V_{DD} = 5 V \pm 5\%$
Input Low Voltage, V_{INL}	0.8	V max	$V_{DD} = 5 V \pm 5\%$
Input Current, I_{IN}	± 1	μA max	Typically 10 nA, $V_{IN} = 0 \text{ V}$ to V_{DD}
Input Capacitance, C_{IN}	10	pF max	
LOGIC OUTPUTS⁴			
F1 and F2			
Output High Voltage, V_{OH}	4.5	V min	$I_{SOURCE} = 10 \text{ mA}$, $V_{DD} = 5 \text{ V}$, $I_{SINK} = 10 \text{ mA}$, $V_{DD} = 5 \text{ V}$
Output Low Voltage, V_{OL}	0.5	V max	
CF			
Output High Voltage, V_{OH}	4	V min	$I_{SOURCE} = 5 \text{ mA}$, $V_{DD} = 5 \text{ V}$, $I_{SINK} = 5 \text{ mA}$, $V_{DD} = 5 \text{ V}$
Output Low Voltage, V_{OL}	0.5	V max	
Frequency Output Error ^{1,2} (CF)	± 10	% ideal typ	External 2.5 V reference, $V_1 = 21.2 \text{ mV rms}$, $V_2 = 116.7 \text{ mV rms}$

AD71056

Parameter	Value	Unit	Test Conditions/Comments
POWER SUPPLY			For specified performance
V_{DD}	4.75	V min	5 V – 5%
	5.25	V max	5 V + 5%
I_{DD}	5	mA max	Typically 4 mA

¹ See the Terminology section for an explanation of specifications.

² See plots in the Typical Performance Characteristics section.

³ See the Analog Inputs section.

⁴ Sample tested during initial release and after any redesign or process change that may affect this parameter.

TIMING CHARACTERISTICS

$V_{DD} = 5\text{ V} \pm 5\%$, $AGND = DGND = 0\text{ V}$, on-chip reference, $R_{CLKIN} = 6.2\text{ k}\Omega$, $0.5\% \pm 50\text{ ppm}/^\circ\text{C}$, T_{MIN} to $T_{MAX} = -40^\circ\text{C}$ to $+85^\circ\text{C}$, unless otherwise noted.

Sample tested during initial release and after any redesign or process change that may affect this parameter. See Figure 2.

Table 2.

Parameter	Specifications	Unit	Test Conditions/Comments
t_1^1	120	ms	F1 and F2 pulse width (logic low).
t_2	See Table 6	sec	Output pulse period. See the Transfer Function section.
t_3	$1/2 t_2$	sec	Time between F1 falling edge and F2 falling edge.
$t_4^{1,2}$	90	ms	CF pulse width (logic high).
t_5	See Table 7	sec	CF pulse period. See the Transfer Function section.
t_6	2	μs	Minimum time between F1 and F2 pulses.

¹ The pulse widths of F1, F2, and CF are not fixed for higher output frequencies. See the Frequency Outputs section.

² The CF pulse is always $35\text{ }\mu\text{s}$ in high frequency mode. See the Frequency Outputs section and Table 7.

Timing Diagram

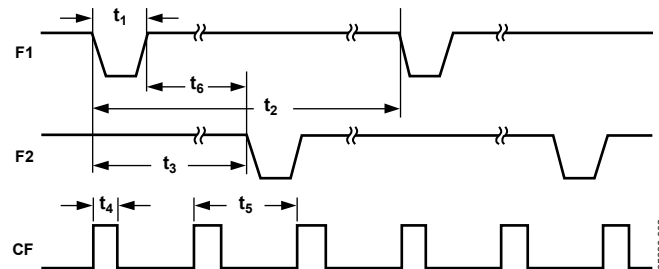

Figure 2. Timing Diagram for Frequency Outputs

ABSOLUTE MAXIMUM RATINGS

$T_A = 25^\circ\text{C}$, unless otherwise noted.

Table 3.

Parameter	Rating
V_{DD} to AGND	-0.3 V to +7 V
V_{DD} to DGND	-0.3 V to +7 V
Analog Input Voltage to AGND V1P, V1N, V2P, and V2N	-6 V to +6 V
Reference Input Voltage to AGND	-0.3 V to $V_{DD} + 0.3$ V
Digital Input Voltage to DGND	-0.3 V to $V_{DD} + 0.3$ V
Digital Output Voltage to DGND	-0.3 V to $V_{DD} + 0.3$ V
Operating Temperature Range	-40°C to $+85^\circ\text{C}$
Storage Temperature Range	-65°C to $+150^\circ\text{C}$
Junction Temperature	150°C
16-Lead Plastic SOIC, Power Dissipation	350 mW
θ_{JA} Thermal Impedance ¹	$124.9^\circ\text{C}/\text{W}$
Package Temperature Soldering	See J-STD-20

¹ JEDEC 1S standard (2-layer) board data.

Stresses above those listed under Absolute Maximum Ratings may cause permanent damage to the device. This is a stress rating only; functional operation of the device at these or any other conditions above those indicated in the operational section of this specification is not implied. Exposure to absolute maximum rating conditions for extended periods may affect device reliability.

ESD CAUTION

ESD (electrostatic discharge) sensitive device. Electrostatic charges as high as 4000 V readily accumulate on the human body and test equipment and can discharge without detection. Although this product features proprietary ESD protection circuitry, permanent damage may occur on devices subjected to high energy electrostatic discharges. Therefore, proper ESD precautions are recommended to avoid performance degradation or loss of functionality.



TERMINOLOGY

Measurement Error

The error associated with the energy measurement made by the AD71056 is defined by the following formula:

$$\%Error = \frac{\text{Energy Registered by AD71056} - \text{True Energy}}{\text{True Energy}} \times 100\%$$

Phase Error Between Channels

The high-pass filter (HPF) in the current channel (Channel V1) has a phase-lead response. To offset this phase response and equalize the phase response between channels, a phase correction network is also placed in Channel V1. The phase correction network matches the phase to within 0.1° over a range of 45 Hz to 65 Hz, and 0.2° over a range 40 Hz to 1 kHz (see Figure 23 and Figure 24).

Power Supply Rejection (PSR)

This quantifies the AD71056 measurement error as a percentage of reading when the power supplies are varied.

For the ac PSR measurement, a reading at nominal supplies (5 V) is taken. A 200 mV rms/100 Hz signal is then introduced onto the supplies and a second reading is obtained under the same input signal levels. Any error introduced is expressed as a percentage of reading—see the Measurement Error definition.

For the dc PSR measurement, a reading at nominal supplies (5 V) is taken. The supplies are then varied 5% and a second reading is obtained with the same input signal levels. Any error introduced is, again, expressed as a percentage of reading.

ADC Offset Error

This refers to the small dc signal (offset) associated with the analog inputs to the ADCs. However, the HPF in Channel V1 eliminates the offset in the circuitry. Therefore, the power calculation is not affected by this offset.

Frequency Output Error (CF)

The frequency output error of the AD71056 is defined as the difference between the measured output frequency (minus the offset) and the ideal output frequency. The difference is expressed as a percentage of the ideal frequency. The ideal frequency is obtained from the AD71056 transfer function. See Figure 14 for a typical distribution of part-to-part variation of CF frequency.

Gain Error

The gain error of the AD71056 is defined as the difference between the measured output of the ADCs (minus the offset) and the ideal output of the ADCs. The difference is expressed as a percentage of the ideal output of the ADCs.

Oscillator Frequency Tolerance

The oscillator frequency tolerance of the AD71056 is defined as the part-to-part frequency variation in terms of percentage at room temperature (25°C). It is measured by taking the difference between the measured oscillator frequency and the nominal frequency as defined in the Specifications section.

Oscillator Frequency Stability

Oscillator frequency stability is defined as the frequency variation in terms of the parts-per-million drift over the operating temperature range. In a metering application, the temperature range is -40°C to +85°C. Oscillator frequency stability is measured by taking the difference between the measured oscillator frequency at -40°C and +85°C and the measured oscillator frequency at +25°C.

PIN CONFIGURATION AND FUNCTION DESCRIPTIONS



Figure 3. Pin Configuration

Table 4. Pin Function Descriptions

Pin No.	Mnemonic	Description
1	V _{DD}	Power Supply. This pin provides the supply voltage for the circuitry in the AD71056. Maintain the supply voltage at $5\text{ V} \pm 5\%$ for specified operation. Decouple this pin with a $10\ \mu\text{F}$ capacitor in parallel with a ceramic $100\ \text{nF}$ capacitor.
2, 3	V2P, V2N	Analog Inputs for Channel V2 (Voltage Channel). These inputs provide a fully differential input pair. The maximum differential input voltage is $\pm 165\ \text{mV}$ for specified operation. Both inputs have internal ESD protection circuitry; an overvoltage of $\pm 6\ \text{V}$ can be sustained on these inputs without risk of permanent damage.
4, 5	V1N, V1P	Analog Inputs for Channel V1 (Current Channel). These inputs are fully differential voltage inputs with a maximum signal level of $\pm 30\ \text{mV}$ with respect to the V1N pin for specified operation. Both inputs have internal ESD protection circuitry and, in addition, an overvoltage of $\pm 6\ \text{V}$ can be sustained on these inputs without risk of permanent damage.
6	AGND	Analog Ground. This pin provides the ground reference for the analog circuitry in the AD71056, that is, the ADCs and reference. Tie this pin to the analog ground plane of the PCB. The analog ground plane is the ground reference for all analog circuitry, such as antialiasing filters, current and voltage sensors, and so forth. For accurate noise suppression, connect the analog ground plane to the digital ground plane at only one point. A star ground configuration helps to keep noisy digital currents away from the analog circuits.
7	REF _{IN/OUT}	Reference Voltage. The on-chip reference has a nominal value of $2.45\ \text{V}$ and a typical temperature coefficient of $20\ \text{ppm}/^\circ\text{C}$. An external reference source can also be connected at this pin. In either case, decouple this pin to AGND with a $1\ \mu\text{F}$ tantalum capacitor and a $100\ \text{nF}$ ceramic capacitor. The internal reference cannot be used to drive an external load.
8	SCF	Select Calibration Frequency. This logic input selects the frequency on the Calibration Output CF. Table 7 shows calibration frequency selections.
9, 10	S1, S0	Conversion Frequency Logic Input Selection. These logic inputs select one of four possible frequencies for the digital-to-frequency conversion. With this logic input, designers have greater flexibility when designing an energy meter. Table 5 shows conversion frequency selections.
11	RCLKIN	On-Chip Clock Enabler. To enable the internal oscillator as a clock source to the chip, a precise low temperature drift resistor at a nominal value of $6.2\ \text{k}\Omega$ must be connected from this pin to DGND.
12	REVP	Negative Power Indicator. This logic output goes high when negative power is detected, such as when the phase angle between the voltage and current signals is greater than 90° . This output is not latched and is reset when positive power is once again detected. The output goes high or low at the same time that a pulse is issued on CF.
13	DGND	Digital Ground. This pin provides the ground reference for the digital circuitry in the AD71056, that is, the multiplier, filters, and digital-to-frequency converter. Tie this pin to the digital ground plane of the PCB. The digital ground plane is the ground reference for all digital circuitry, for example, counters (mechanical and digital), MCUs, and indicator LEDs. For accurate noise suppression, connect the analog ground plane to the digital ground plane at one point only—a star ground.
14	CF	Calibration Frequency Logic Output. The CF logic output provides instantaneous real power information. This output is for calibration purposes (also see the SCF pin description).
15, 16	F2, F1	Low Frequency Logic Outputs. F1 and F2 supply average real power information. The logic outputs can be used to directly drive electromechanical counters and 2-phase stepper motors. See the Transfer Function section.

TYPICAL PERFORMANCE CHARACTERISTICS

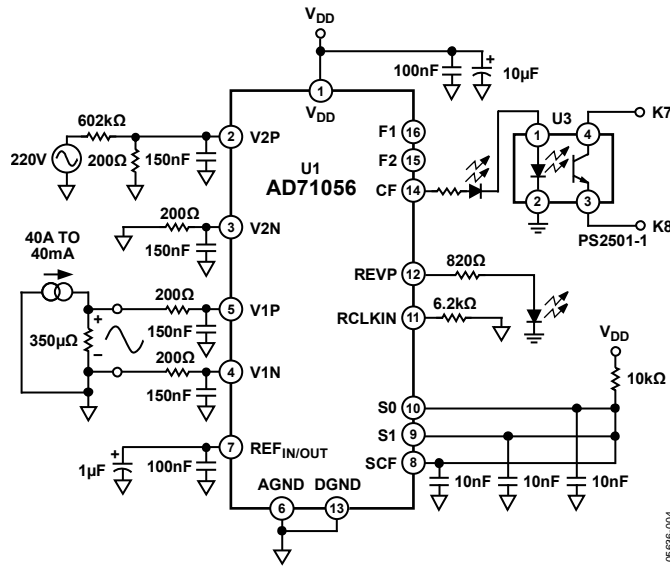

Figure 4. Test Circuit for Performance Curves

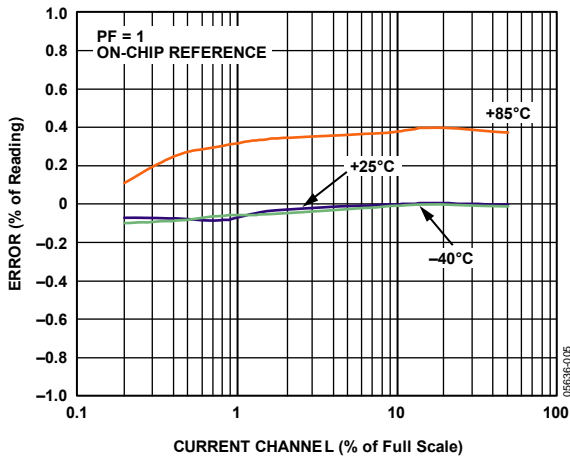

Figure 5. Error as a % of Reading over Temperature with On-Chip Reference (PF = 1)

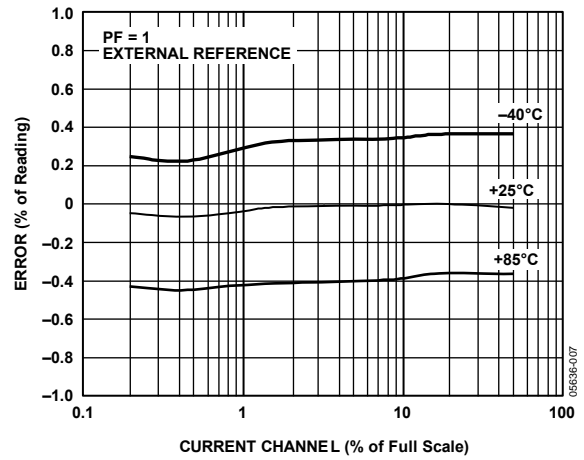

Figure 7. Error as a % of Reading over Temperature with External Reference (PF = 1)

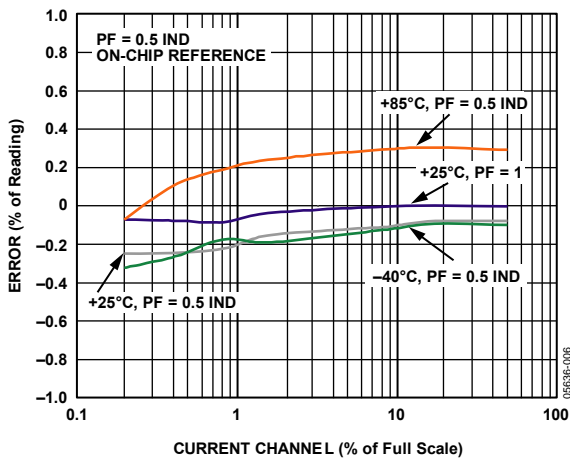

Figure 6. Error as a % of Reading over Temperature with On-Chip Reference (PF = 0.5 IND)

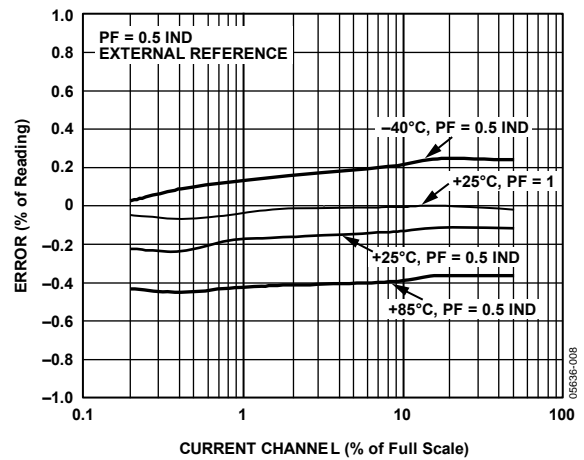

Figure 8. Error as a % of Reading over Temperature with External Reference (PF = 0.5 IND)

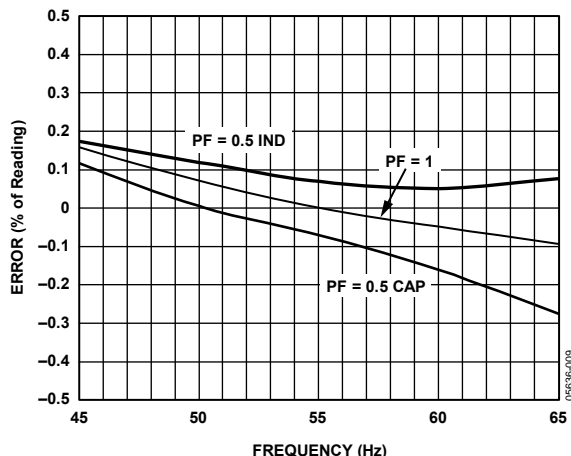

Figure 9. Error as a % of Reading over Input Frequency

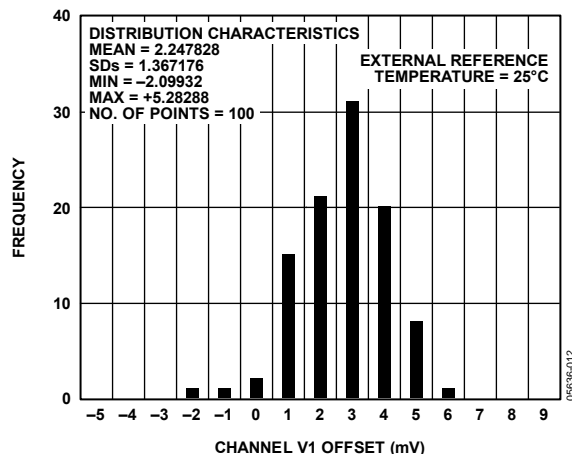

Figure 12. Channel V1 Offset Distribution



Figure 10. PSR with On-Chip Reference, PF = 1

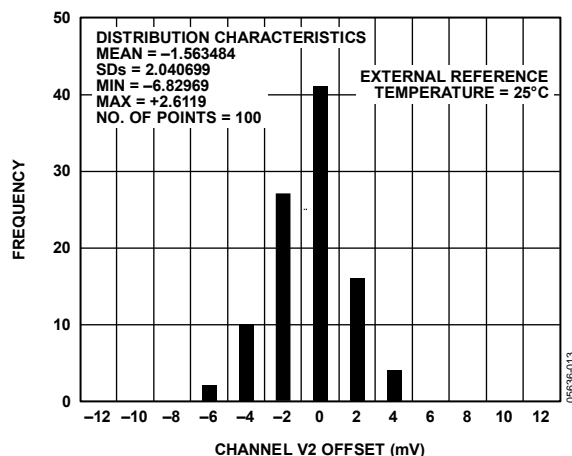

Figure 13. Channel V2 Offset Distribution



Figure 11. PSR with External Reference, PF = 1

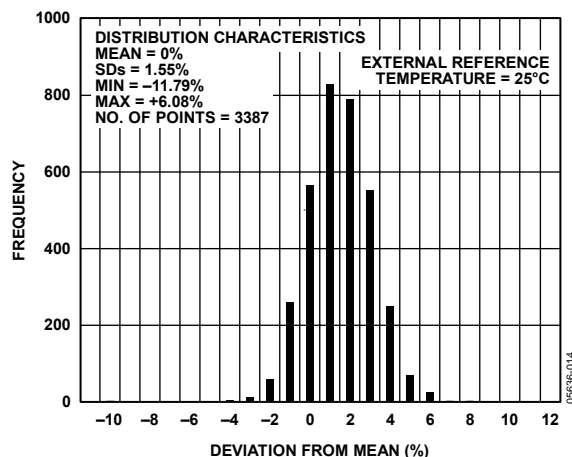

Figure 14. Part-to-Part CF Distribution from Mean of CF

THEORY OF OPERATION

The two ADCs in the AD71056 digitize the voltage signals from the current and voltage sensors. These ADCs are 16-bit, Σ - Δ with an oversampling rate of 450 kHz. This analog input structure greatly simplifies sensor interfacing by providing a wide dynamic range for direct connection to the sensor and also simplifies the antialiasing filter design. A high-pass filter in the current channel removes any dc component from the current signal. This eliminates any inaccuracies in the real power calculation due to offsets in the voltage or current signals.

The real power calculation is derived from the instantaneous power signal. The instantaneous power signal is generated by a direct multiplication of the current and voltage signals. To extract the real power component (that is, the dc component), the instantaneous power signal is low-pass filtered. Figure 15 illustrates the instantaneous real power signal and shows how the real power information is extracted by low-pass filtering the instantaneous power signal. This scheme correctly calculates real power for sinusoidal current and voltage waveforms at all power factors. All signal processing is carried out in the digital domain for superior stability over temperature and time.

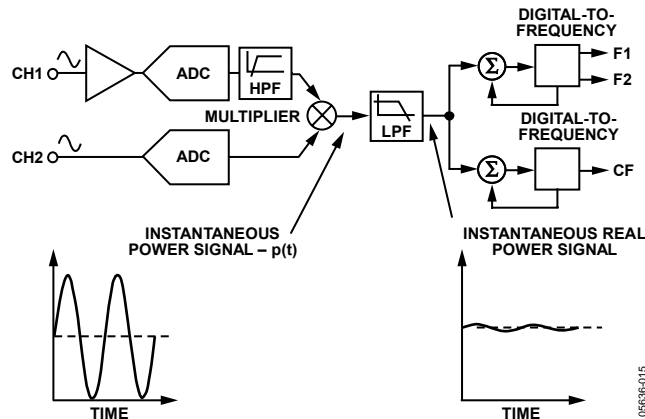

Figure 15. Signal Processing Block Diagram

The low frequency outputs (F1, F2) of the AD71056 are generated by accumulating this real power information. This low frequency inherently means a long accumulation time between output pulses. Consequently, the resulting output frequency is proportional to the average real power. This average real power information is then accumulated (for example, by a counter) to generate real energy information. Conversely, due to its high output frequency and, hence, shorter integration time, the CF output frequency is proportional to the instantaneous real power. This is useful for system calibration that can be done faster under steady load conditions.

POWER FACTOR CONSIDERATIONS

The method used to extract the real power information from the instantaneous power signal (that is, by low-pass filtering) is valid even when the voltage and current signals are not in phase. Figure 16 displays the unity power factor condition and a displacement power factor (DPF) = 0.5; that is, the current signal lagging the voltage by 60°. Assuming the voltage and current waveforms are sinusoidal, the real power component of the instantaneous power signal (the dc term) is given by

$$\left(\frac{V \times I}{2}\right) \times \cos(60^\circ) \tag{1}$$

This is the correct real power calculation.

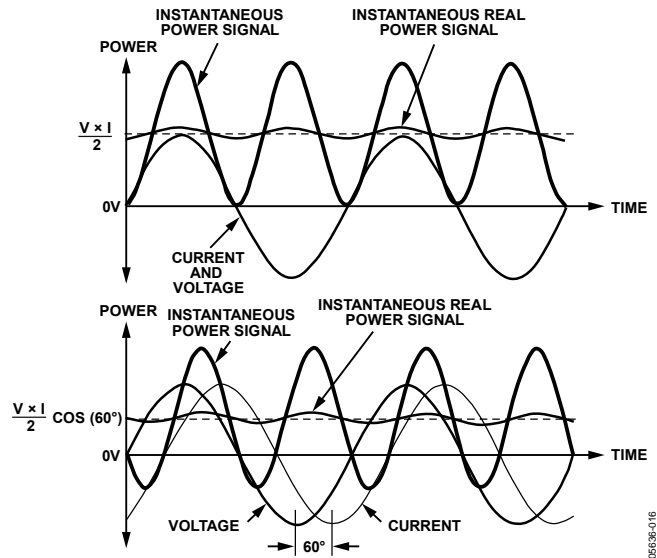

Figure 16. DC Component of Instantaneous Power Signal Conveys Real Power Information, PF < 1

NONSINUSOIDAL VOLTAGE AND CURRENT

The real power calculation method also holds true for non-sinusoidal current and voltage waveforms. All voltage and current waveforms in practical applications have some harmonic content. Using the Fourier transform, instantaneous voltage and current waveforms can be expressed in terms of their harmonic content.

$$v(t) = V_0 + \sqrt{2 \times \sum_{h=1}^{\infty} V_h^2} \times \sin(h\omega t + \alpha_h) \tag{2}$$

where:

$v(t)$ is the instantaneous voltage.

V_0 is the average value.

V_h is the rms value of Voltage Harmonic h .

α_h is the phase angle of the voltage harmonic.

$$i(t) = I_0 + \sqrt{2} \times \sum_{h \neq 0}^{\infty} I_h \times \sin(h\omega t + \beta_h) \quad (3)$$

where:

$i(t)$ is the instantaneous current.

I_0 is the dc component.

I_h is the rms value of Current Harmonic h .

β_h is the phase angle of the current harmonic.

Using Equation 2 and Equation 3, the real power, P , can be expressed in terms of its fundamental real power (P_1) and harmonic real power (P_H) as

$$P = P_1 + P_H$$

where:

$$P_1 = V_1 \times I_1 \cos \phi_1 \quad (4)$$

$$\phi_1 = \alpha_1 - \beta_1$$

and P_H

$$P_H = \sum_{h \neq 1}^{\infty} V_h \times I_h \cos \phi_h \quad (5)$$

$$\phi_h = \alpha_h - \beta_h$$

In Equation 5, a harmonic real power component is generated for every harmonic, provided that harmonic is present in both the voltage and current waveforms. The power factor calculation has previously been shown to be accurate in the case of a pure sinusoid. Therefore, the harmonic real power must also correctly account for the power factor because it is made up of a series of pure sinusoids.

Note that the input bandwidth of the analog inputs is 7 kHz at the nominal internal oscillator frequency of 450 kHz.

APPLICATIONS

ANALOG INPUTS

Channel V1 (Current Channel)

The voltage output from the current sensor is connected to the AD71056 at Channel V1. Channel V1 is a fully differential voltage input. V1P is the positive input with respect to V1N.

The maximum peak differential signal on Channel V1 should be less than ± 30 mV (21 mV rms for a pure sinusoidal signal) for specified operation.

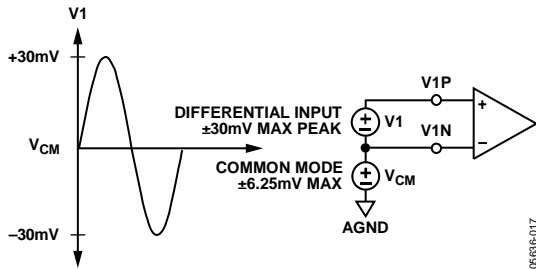

Figure 17. Maximum Signal Levels, Channel V1

Figure 17 illustrates the maximum signal levels on V1P and V1N. The maximum differential voltage is ± 30 mV. The differential voltage signal on the inputs must be referenced to a common mode, such as AGND. The maximum common-mode signal is ± 6.25 mV, as shown in Figure 17.

Channel V2 (Voltage Channel)

The output of the line voltage sensor is connected to the AD71056 at Channel V2. Channel V2 is a fully differential voltage input with a maximum peak differential signal of ± 165 mV.

Figure 18 illustrates the maximum signal levels that can be connected to the AD71056 Channel V2.

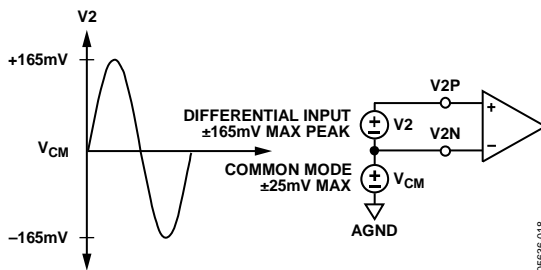

Figure 18. Maximum Signal Levels, Channel V2

Channel V2 is usually driven from a common-mode voltage, that is, the differential voltage signal on the input is referenced to a common mode (usually AGND). The analog inputs of the AD71056 can be driven with common-mode voltages of up to 25 mV with respect to AGND. However, best results are achieved using a common mode equal to AGND.

Typical Connection Diagrams

Figure 19 shows a typical connection diagram for Channel V1. A shunt is the current sensor selected for this example because of its low cost compared to other current sensors, such as the current transformer (CT). This IC is ideal for low current meters.

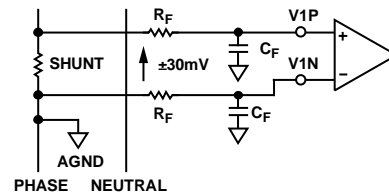

Figure 19. Typical Connection for Channel V1

Figure 20 shows a typical connection for Channel V2. Typically, the AD71056 is biased around the phase wire and a resistor divider is used to provide a voltage signal that is proportional to the line voltage. Adjusting the ratio of R_A , R_B , and R_F is also a convenient way of carrying out a gain calibration on a meter.

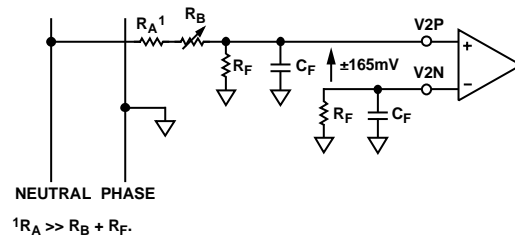

Figure 20. Typical Connections for Channel V2

POWER SUPPLY MONITOR

The AD71056 contains an on-chip power supply monitor. The power supply (V_{DD}) is continuously monitored by the AD71056. If the supply is less than 4 V, the AD71056 becomes inactive. This is useful to ensure proper device operation at power-up and power-down. The power supply monitor has built-in hysteresis and filtering that provide a high degree of immunity to false triggering from noisy supplies.

In Figure 21, the trigger level is nominally set at 4 V. The tolerance on this trigger level is within $\pm 5\%$. The power supply and decoupling for the part should be such that the ripple at V_{DD} does not exceed $5\text{ V} \pm 5\%$ as specified for normal operation.

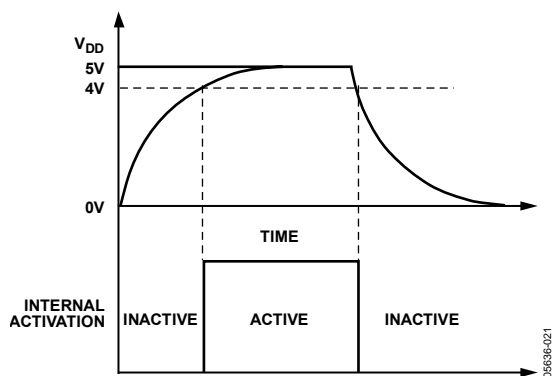

Figure 21. On-Chip Power Supply Monitor

HPF and Offset Effects

Figure 22 illustrates the effect of offsets on the real power calculation. As can be seen, offsets on Channel V1 and Channel V2 contribute a dc component after multiplication. Because this dc component is extracted by the LPF and used to generate the real power information, the offsets contribute a constant error to the real power calculation. This problem is easily avoided by the built-in HPF in Channel V1. By removing the offsets from at least one channel, no error component can be generated at dc by the multiplication. Error terms at the line frequency (ω) are removed by the LPF and the digital-to-frequency conversion (see the Digital-to-Frequency Conversion section).

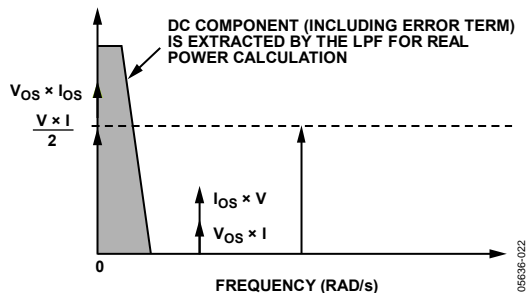

Figure 22. Effect of Channel Offset on the Real Power Calculation

Equation 6 shows how the power calculation is affected by the dc offsets in the current and voltage channels.

$$\begin{aligned} & \{V \cos(\omega t) + V_{OS}\} \times \{I \cos(\omega t) + I_{OS}\} \tag{6} \\ & = \frac{V \times I}{2} + V_{OS} \times I_{OS} + V_{OS} \times I \cos(\omega t) + I_{OS} \times V \cos(\omega t) \\ & \quad + \frac{V \times I}{2} \times \cos(2\omega t) \end{aligned}$$

The HPF in Channel V1 has an associated phase response that is compensated for on chip. Figure 23 and Figure 24 show the phase error between channels with the compensation network activated. The AD71056 is phase compensated up to 1 kHz as shown. This ensures correct active harmonic power calculation even at low power factors.

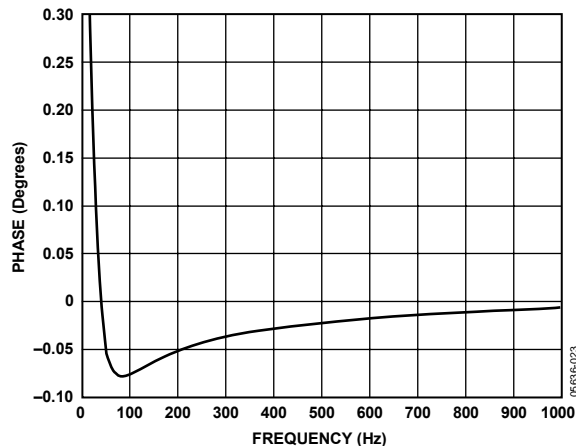

Figure 23. Phase Error Between Channels (0 Hz to 1 kHz)

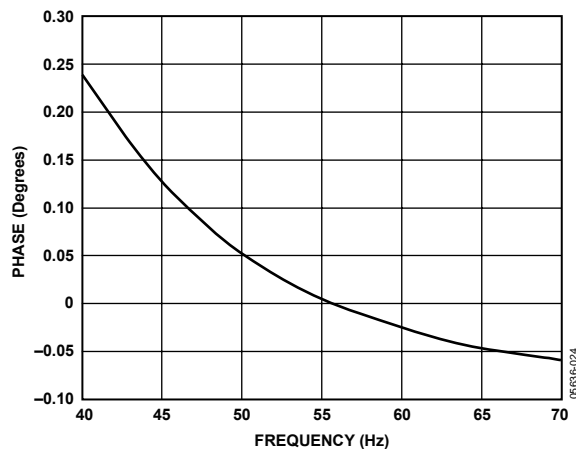

Figure 24. Phase Error Between Channels (40 Hz to 70 Hz)

Digital-to-Frequency Conversion

As previously described, the digital output of the low-pass filter after multiplication contains the real power information. However, because this LPF is not an ideal brick wall filter implementation, the output signal also contains attenuated components at the line frequency and its harmonics—that is, $\cos(h\omega t)$, where $h = 1, 2, 3, \dots$ and so on.

The magnitude response of the filter is given by

$$|H(f)| = \frac{1}{\sqrt{1 + \frac{f^2}{4.45^2}}} \quad (7)$$

For a line frequency of 50 Hz, this gives an attenuation of the 2ω (100 Hz) component of approximately 22 dB. The dominating harmonic is twice the line frequency (2ω) due to the instantaneous power calculation.

Figure 25 shows the instantaneous real power signal at the output of the LPF that still contains a significant amount of instantaneous power information, that is, $\cos(2\omega t)$. This signal is then passed to the digital-to-frequency converter where it is integrated (accumulated) over time to produce an output frequency. The accumulation of the signal suppresses or averages out any non-dc components in the instantaneous real power signal. The average value of a sinusoidal signal is zero. Thus, the frequency generated by the AD71056 is proportional to the average real power. Figure 25 shows the digital-to-frequency conversion for steady load conditions, that is, constant voltage and current.

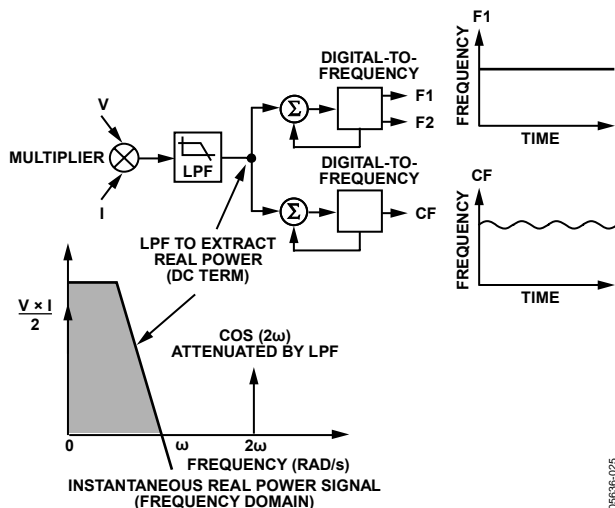

Figure 25. Real Power-to-Frequency Conversion

Figure 25 shows that the frequency output CF varies over time, even under steady load conditions. This frequency variation is primarily due to the $\cos(2\omega t)$ component in the instantaneous real power signal. The output frequency on CF can be up to 2048 times higher than the frequency on F1 and F2.

This higher output frequency is generated by accumulating the instantaneous real power signal over a much shorter time while converting it to a frequency. This shorter accumulation period means less averaging of the $\cos(2\omega t)$ component. Consequently, some of this instantaneous power signal passes through the digital-to-frequency conversion. This is not a problem in the application. Where CF is used for calibration purposes, the frequency should be averaged by the frequency counter to remove any ripple. If CF is being used to measure energy, for example in a microprocessor-based application, the CF output should also be averaged to calculate power.

Because the F1 and F2 outputs operate at a much lower frequency, a lot more averaging of the instantaneous real power signal is carried out. The result is a greatly attenuated sinusoidal content and a virtually ripple free frequency output.

Connecting to a Microcontroller for Energy Measurement

The easiest way to interface the AD71056 to a microcontroller is to use the CF high frequency output with the output frequency scaling set to $2048 \times F1, F2$. This is done by setting $SCF = 0$ and $S0 = S1 = 1$ (see Table 7). With full-scale ac signals on the analog inputs, the output frequency on CF is approximately 2.867 kHz. Figure 26 illustrates one scheme to digitize the output frequency and carry out the necessary averaging mentioned in the Digital-to-Frequency Conversion section.

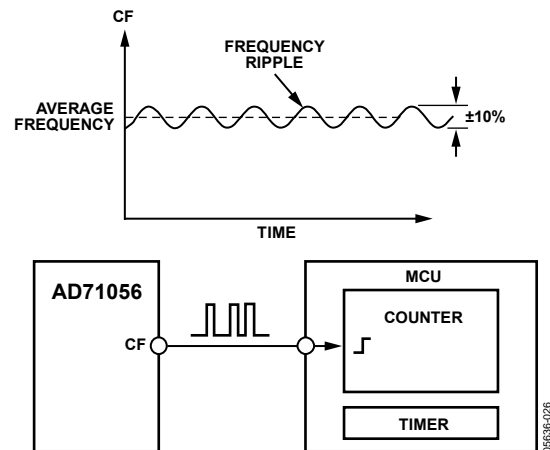

Figure 26. Interfacing the AD71056 to an MCU

As shown, the frequency output CF is connected to an MCU counter or port. This counts the number of pulses in a given integration time that is determined by an MCU internal timer. The average power proportional to the average frequency is given by

$$\text{Average Frequency} = \text{Average Power} = \frac{\text{Counter}}{\text{Time}} \quad (8)$$

The energy consumed during an integration period is given by

$$\text{Energy} = \text{Average Power} \times \text{Time} = \frac{\text{Counter}}{\text{Time}} \times \text{Time} = \text{Counter} \quad (9)$$

For the purpose of calibration, this integration time can be as long as 10 seconds to 20 seconds to accumulate enough pulses to ensure correct averaging of the frequency. In normal operation, the integration time can be reduced to one or two seconds, depending, for example, on the required update rate of a display. With shorter integration times on the MCU, the amount of energy in each update can still have some small amount of ripple, even under steady load conditions. However, over a minute or more the measured energy has no ripple.

Power Measurement Considerations

Calculating and displaying power information always has some associated ripple that depends on the load as well as the integration period used in the MCU to determine average power. For example, at light loads, the output frequency may be 10 Hz. With an integration period of two seconds, only about 20 pulses are counted. The possibility of missing one pulse always exists, because the output frequency of the AD71056 is running asynchronously to the MCU timer. This results in a 1-in-20, or 5%, error in the power measurement.

INTERNAL OSCILLATOR (OSC)

The nominal internal oscillator frequency is 450 kHz when used with RCLKIN, with a nominal value of 6.2 kΩ. The frequency outputs are directly proportional to the oscillator frequency, thus RCLKIN must have low tolerance and low temperature drift to ensure stability and linearity of the chip. The oscillator frequency is inversely proportional to the RCLKIN, as shown in Figure 27. Although the internal oscillator operates when used with RCLKIN values between 5.5 kΩ and 20 kΩ, choosing a value within the range of the nominal value, as shown in Figure 27, is recommended.

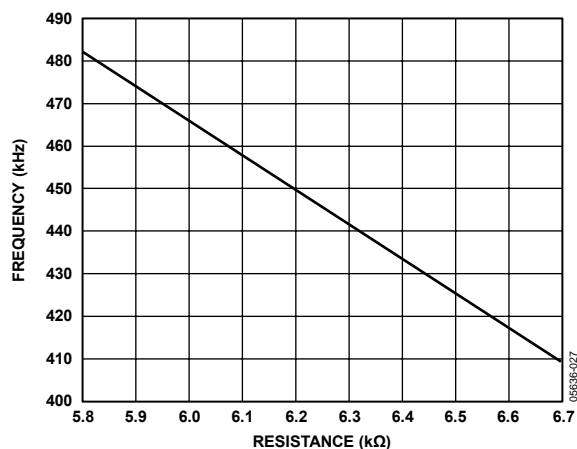

Figure 27. Effect of RCLKIN on Internal Oscillator Frequency (OSC)

TRANSFER FUNCTION

Frequency Outputs F1 and F2

The AD71056 calculates the product of two voltage signals (on Channel V1 and Channel V2) and then low-pass filters this product to extract real power information. This real power information is then converted to a frequency. The frequency information is output on F1 and F2 in the form of active low pulses. The pulse rate at these outputs is relatively low, for example, 0.175 Hz maximum for ac signals with S0 = S1 = 0 (see Table 6). This means that the frequency at these outputs is generated from real power information accumulated over a relatively long period of time. The result is an output frequency that is proportional to the average real power. The averaging of the real power signal is implicit to the digital-to-frequency conversion. The output frequency or pulse rate is related to the input voltage signals by the following equation:

$$\text{Freq} = \frac{494.75 \times V1_{rms} \times V2_{rms} \times f_{1...4}}{V_{REF}^2} \quad (10)$$

where:

Freq = output frequency on F1 and F2 (Hz).

V1_{rms} = differential rms voltage signal on Channel V1 (V).

V2_{rms} = differential rms voltage signal on Channel V2 (V).

V_{REF} = the reference voltage (2.45 V ±200 mV) (V).

f_{1...4} = one of four possible frequencies selected by using Logic Input S0 and Logic Input S1 (see Table 5).

Table 5. f_{1...4} Frequency Selection

S1	S0	OSC Relation ¹	f _{1...4} at Nominal OSC (Hz) ²
0	0	OSC/2 ¹⁹	0.86
0	1	OSC/2 ¹⁸	1.72
1	0	OSC/2 ¹⁷	3.43
1	1	OSC/2 ¹⁶	6.86

¹ f_{1...4} is a binary fraction of the internal oscillator frequency (OSC).

² Values are generated using the nominal frequency of 450 kHz.

Example

In this example, with ac voltages of ±30 mV peak applied to V1 and ±165 mV peak applied to V2, the expected output frequency is calculated as

$$f_{1...4} = \text{OSC}/2^{19} \text{ Hz}, S0 = S1 = 0$$

$$V1_{rms} = 0.03/\sqrt{2} \text{ V}$$

$$V2_{rms} = 0.165/\sqrt{2} \text{ V}$$

$$V_{REF} = 2.45 \text{ V (nominal reference value)}$$

Note that if the on-chip reference is used, actual output frequencies can vary from device to device due to the reference tolerance of ±200 mV.

$$\text{Freq} = \frac{494.75 \times 0.03 \times 0.165 \times f_1}{\sqrt{2} \times \sqrt{2} \times 2.45^2} = 0.204 \times f_1 = 0.175 \quad (11)$$

Table 6. Maximum Output Frequency on the F1 and F2 Pins

S1	S0	OSC Relation	Max Frequency ¹ or AC Inputs (Hz)
0	0	$0.204 \times f_1$	0.175
0	1	$0.204 \times f_2$	0.35
1	0	$0.204 \times f_3$	0.70
1	1	$0.204 \times f_4$	1.40

¹Values are generated using the nominal frequency of 450 kHz.

Frequency Output CF

The Pulse Output CF (calibration frequency) is intended for calibration purposes. The output pulse rate on CF can be up to 2048 times the pulse rate on the F1 and F2 pins. The lower the $f_{1...4}$ frequency selected, the higher the CF scaling (except for the high frequency mode where SCF = 0, S1 = S0 = 1). Table 7 shows how the two frequencies are related, depending on the states of the logic inputs (S0, S1, and SCF). Due to its relatively high pulse rate, the frequency at the CF logic output is proportional to the instantaneous real power. As with F1 and F2, CF is derived from the output of the low-pass filter after multiplication. However, because the output frequency is high, this real power information is accumulated over a much shorter time. Therefore, less averaging is carried out in the digital-to-frequency conversion. With much less averaging of the real power signal, the CF output is much more responsive to power fluctuations (see the signal processing block in Figure 15).

Table 7. Maximum Output Frequency on CF

SCF	S1	S0	CF Max for AC Signals (Hz) ¹
1	0	0	$128 \times F1, F2 = 22.4$
0	0	0	$64 \times F1, F2 = 11.2$
1	0	1	$64 \times F1, F2 = 22.4$
0	0	1	$32 \times F1, F2 = 11.2$
1	1	0	$32 \times F1, F2 = 22.4$
0	1	0	$16 \times F1, F2 = 11.2$
1	1	1	$16 \times F1, F2 = 22.4$
0	1	1	$2048 \times F1, F2 = 2.867 \text{ kHz}$

¹Values are generated using the nominal frequency of 450 kHz.

SELECTING A FREQUENCY FOR AN ENERGY METER APPLICATION

As listed in Table 5, the user can select one of four frequencies. This frequency selection determines the maximum frequency on the F1 and F2 pins. These outputs are intended for driving an energy register (electromechanical or other). Because only four different output frequencies can be selected, the available frequency selection is optimized for a meter constant of 100 imp/kWh with a maximum current between 10 A and 120 A. Table 8 shows the output frequency for several maximum currents (I_{MAX}) with a line voltage of 220 V. In all cases, the meter constant is 100 imp/kWh.

Table 8. F1 and F2 Frequency at 100 imp/kWh

I_{MAX} (A)	F1 and F2 (Hz)
12.5	0.076
25.0	0.153
40.0	0.244
60.0	0.367
80.0	0.489
120.0	0.733

The $f_{1...4}$ frequencies allow complete coverage of this range of output frequencies (F1, F2). When designing an energy meter, the nominal design voltage on Channel V2 (voltage) should be set to half-scale to allow for calibration of the meter constant. The current channel should also be no more than half-scale when the meter sees maximum load. This allows overcurrent signals and signals with high crest factors to be accommodated. Table 9 lists the output frequency on the F1 and F2 pins when both analog inputs are half-scale. The frequencies listed in Table 9 align very well with those listed in Table 8 for maximum load.

Table 9. F1 and F2 Frequency with Half-Scale AC Inputs

S1	S0	$f_{1...4}$ (Hz)	Frequency on F1 and F2— CH1 and CH2 Half-Scale AC Input ¹	
0	0	0.86	$0.051 \times f_1$	0.044 Hz
0	1	1.72	$0.051 \times f_2$	0.088 Hz
1	0	3.43	$0.051 \times f_3$	0.176 Hz
1	1	6.86	$0.051 \times f_4$	0.352 Hz

¹Values are generated using the nominal frequency of 450 kHz.

When selecting a suitable $f_{1...4}$ frequency for a meter design, compare the frequency output at I_{MAX} (maximum load) based on a meter constant of 100 imp/kWh against the last column of Table 9. The closest frequency in Table 9 determines the best choice of frequency ($f_{1...4}$). For example, if a meter with a maximum current of 25 A is being designed, the output frequency on the F1 and F2 pins with a meter constant of 100 imp/kWh is 0.153 Hz at 25 A and 220 V (from Table 8). In the last column of Table 9, the closest frequency to 0.153 Hz is 0.176 Hz. Therefore, f_3 (3.43 Hz) is selected for this design (see Table 5).

Frequency Outputs

Figure 2 shows a timing diagram for the various frequency outputs. The outputs (F1 and F2) are the low frequency outputs that can be used to directly drive a stepper motor or electro-mechanical impulse counter. The F1 and F2 outputs provide two alternating low frequency pulses. The F1 and F2 pulse widths (t_i) are set such that if they fall below 240 ms (0.24 Hz), they are set to half of their period. The maximum output frequencies for F1 and F2 are shown in Table 6.

The high frequency CF output is intended to be used for communications and calibration purposes. CF produces a 90-ms-wide active high pulse (t_i) at a frequency proportional

to active power. The CF output frequencies are given in Table 7. As with F1 and F2, if the period of CF (t_5) falls below 180 ms, the CF pulse width is set to half the period. If the CF frequency, for example, is 20 Hz, the CF pulse width is 25 ms.

When the high frequency mode is selected (that is, $SCF = 0$, $S1 = S0 = 1$), the CF pulse width is fixed at 35 μ s. Therefore, t_4 is always 35 μ s, regardless of the output frequency on CF.

NO LOAD THRESHOLD

The AD71056 also includes a no load threshold and start-up current feature that eliminates any creep effects in the meter. The AD71056 is designed to issue a minimum output frequency. Any load generating a frequency lower than this minimum frequency does not cause a pulse to be issued on F1, F2, or CF. The minimum output frequency is given as 0.00244% for each of the $f_{1...4}$ frequency selections (see Table 5).

For example, for an energy meter with a meter constant of 100 imp/kWh on F1, F2 using f_3 (3.43 Hz), the minimum

output frequency at F1 or F2 equals 0.00244% of 3.43 Hz or 8.38×10^{-5} Hz. This is 2.68×10^{-3} Hz at CF ($32 \times F1$ Hz) when $SCF = S0 = 1$, $S1 = 0$. In this example, the no load threshold is equivalent to 3 W of load or a start-up current of 13.72 mA at 220 V. Compare this value to the IEC62053-21 specification that states the meter must start up with a load equal to or less than 0.4% I_b . For a 5 A (I_b) meter, 0.4% of I_b is equivalent to 20 mA.

NEGATIVE POWER INFORMATION

The AD71056 detects when the current and voltage channels have a phase shift greater than 90° . This mechanism can detect wrong connection of the meter or generation of negative power.

The REVP pin output goes active high when negative power is detected and active low when positive power is detected. The REVP pin output changes state as a pulse is issued on CF.

AD71056

OUTLINE DIMENSIONS

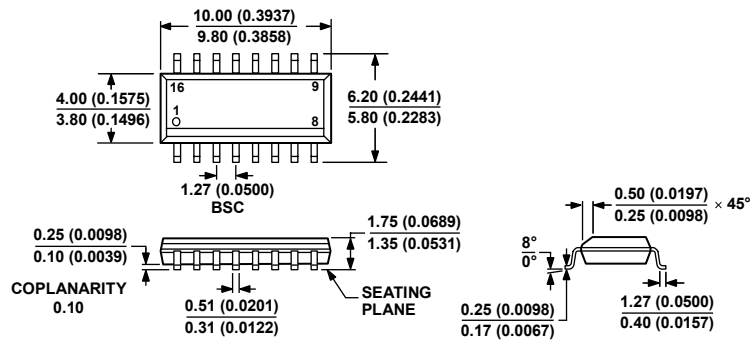

COMPLIANT TO JEDEC STANDARDS MS-012-AC
 CONTROLLING DIMENSIONS ARE IN MILLIMETERS; INCH DIMENSIONS
 (IN PARENTHESES) ARE ROUNDED-OFF MILLIMETER EQUIVALENTS FOR
 REFERENCE ONLY AND ARE NOT APPROPRIATE FOR USE IN DESIGN.

Figure 28. 16-Lead Standard Small Outline Package [SOIC_N]
 Narrow Body (R-16)

Dimensions shown in millimeters and (inches)

060606-A

ORDERING GUIDE

Model	Temperature Range	Package Description	Package Option
AD71056AR	-40°C to +85°C	16-Lead SOIC_N	R-16
AD71056AR-RL	-40°C to +85°C	16-Lead SOIC_N, Reel	R-16
AD71056ARZ ¹	-40°C to +85°C	16-Lead SOIC_N	R-16
AD71056ARZ-RL ¹	-40°C to +85°C	16-Lead SOIC_N, Reel	R-16

¹ Z = Pb-free part.

NOTES

AD71056

NOTES

Компания «Life Electronics» занимается поставками электронных компонентов импортного и отечественного производства от производителей и со складов крупных дистрибьюторов Европы, Америки и Азии.

С конца 2013 года компания активно расширяет линейку поставок компонентов по направлению коаксиальный кабель, кварцевые генераторы и конденсаторы (керамические, пленочные, электролитические), за счёт заключения дистрибьюторских договоров

Мы предлагаем:

- Конкурентоспособные цены и скидки постоянным клиентам.
- Специальные условия для постоянных клиентов.
- Подбор аналогов.
- Поставку компонентов в любых объемах, удовлетворяющих вашим потребностям.
- Приемлемые сроки поставки, возможна ускоренная поставка.
- Доставку товара в любую точку России и стран СНГ.
- Комплексную поставку.
- Работу по проектам и поставку образцов.
- Формирование склада под заказчика.
- Сертификаты соответствия на поставляемую продукцию (по желанию клиента).
- Тестирование поставляемой продукции.
- Поставку компонентов, требующих военную и космическую приемку.
- Входной контроль качества.
- Наличие сертификата ISO.

В составе нашей компании организован Конструкторский отдел, призванный помогать разработчикам, и инженерам.

Конструкторский отдел помогает осуществить:

- Регистрацию проекта у производителя компонентов.
- Техническую поддержку проекта.
- Защиту от снятия компонента с производства.
- Оценку стоимости проекта по компонентам.
- Изготовление тестовой платы монтаж и пусконаладочные работы.



Тел: +7 (812) 336 43 04 (многоканальный)

Email: org@lifeelectronics.ru