

# K12 High Performance Key Switches

## Features/Benefits

- Excellent tactile feel
- Wide choice of LED colors, travel and actuator forces
- High reliability / long life
- Sealed version available
- Designed for low-level switching
- Double stroke version available
- Detector version available

## Typical Applications

- Automotive
- Off-road transportation
- Industrial electronics
- Computers & network equipment
- Joysticks



## Construction:

FUNCTION: momentary  
 DISTANCE BETWEEN BUTTON CENTERS:  
 min. 11 (0.433) K12C = 13 (0.512)  
 TERMINALS: PC pins, tinned  
 MOUNTING: Locating pins; K12G and K12P additionally  
 with snap-in housing

## Mechanical

TOTAL TRAVEL: 1 mm, 1.5 mm, 2 mm  
 SWITCHING TRAVEL: 0.6 mm\*  
 OPERATING FORCE: 1.5 N OD without snap-point as detector  
 switch, 2.5 N, 3.5 N, 5 N, 3.5/7 N, 6/12 N. Additional  
 operating force 7N, 9N and 20N, available on request.  
 PROTECTION CLASS: K12C IP 67 (dust tight, protected against  
 the effects of immersion in water; other versions IP 40)

\* Additional switching travel (with pre-travel) available by request.

## Packaging

Bulk in boxes of 250 pieces (version C or GO) or  
 300 pieces (version A, AL, P or PL)

## Electrical

SWITCHING POWER MIN./MAX.: 0.02mW/3 W  
 SWITCHING VOLTAGE MIN./MAX.: 2 V DC / 30 V DC  
 SWITCHING CURRENT MIN./MAX.: 10 mA /100 mA  
 DIELECTRIC STRENGTH (50 Hz, 1 min): ≥ 500 V  
 OPERATING LIFE with max. switching power: ≥ 10<sup>6</sup> operations  
 K12G & K12GO; operating life of second switch 5 x 10<sup>4</sup> operations,  
 operating life K12C and version with more than 6N (7N, 9N 20N)  
 please consult factory.  
 CONTACT RESISTANCE: Initial ≤ 50 mΩ  
 INSULATION RESISTANCE: ≥ 10<sup>10</sup> Ω  
 BOUNCE TIME: ≤ 1 ms  
 Operating speed 100 mm/s (3.94/s)

## Environmental

OPERATING TEMPERATURE: -40°C to 85°C.  
 STORAGE TEMPERATURE: -40°C to 95°C.

## Process

SOLDERABILITY:  
 Wave soldering, compatible with lead free soldering profile  
 Hand soldering, 350°C

## How To Order

Our easy build-a-switch concept allows you to mix and match options to create the switch you need. To order, select desired option from each category and place it in the appropriate box.

Note: Some of the configurations may not be available or could require some development.

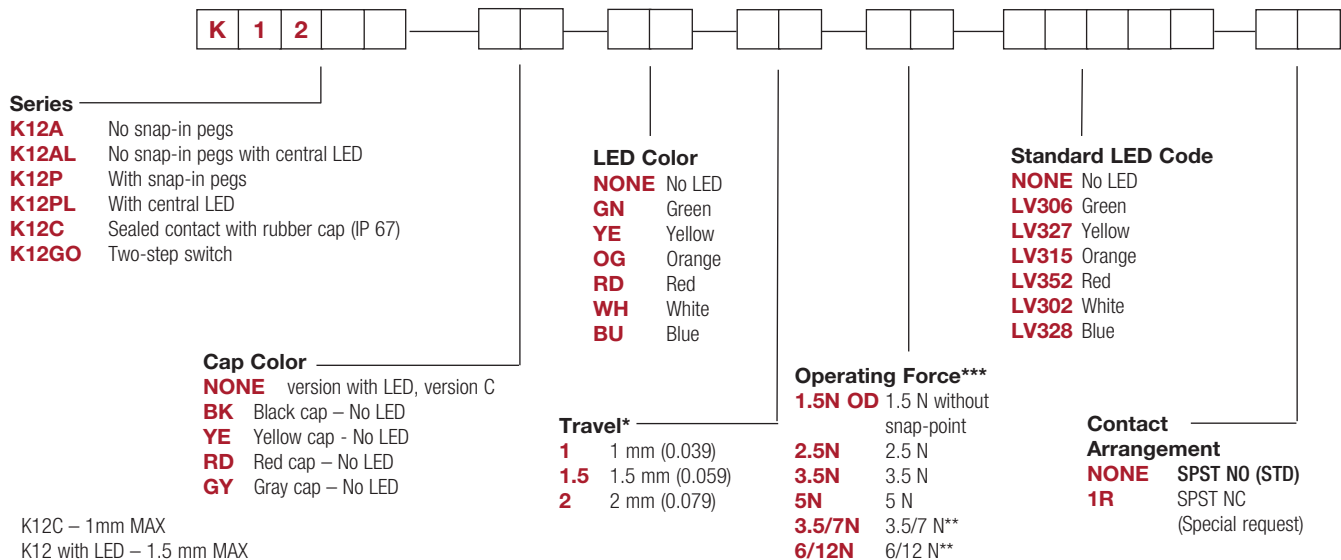

\* K12C – 1mm MAX

K12 with LED – 1.5 mm MAX

\*\* K12G & K12GO version only

\*\*\* Additional operating force: 7N, 9N available on request

# K12 High Performance Key Switches

SERIES

**K12A** without snap in



PCB LAYOUT, MOUNTING SIDE

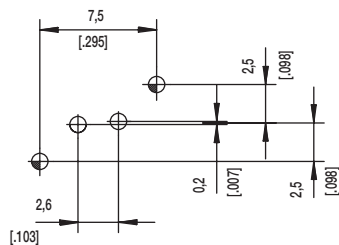

**K12AL**



PCB LAYOUT, MOUNTING SIDE

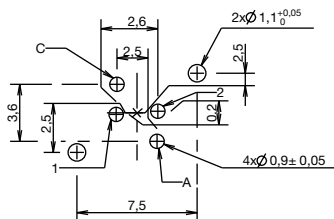

ELECTRICAL GRAPH

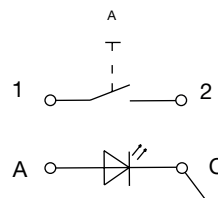

	$1,1^{+0,05}$	2x	2x	center hole		
	$0,9 \pm 0,05$		2x	LED	$\varnothing 0,5 (,020)$	Sn
		2x	2x	switch	$0,7 \times 0,2 (,028 \times 0,081)$	Sn
Hole	$\varnothing$	Without	with LED	Description	Terminal Section	Surface

# K12 High Performance Key Switches

SERIES

## K12P with snap in



### PCB LAYOUT, MOUNTING SIDE



center of actuation area (notice LED)

Hole	Ø	Without LED	Description	Terminal Section	Surface
	1,7 (.069)	2x	snap-in		
	1,6 (.062)	1x	coding hole (L,M,N)		
	1,1 (.043)	2x	center hole		Sn
	0,9 (.035)	2x	switch	0.7 x 0.2 (.028 x .081)	Sn

## K12PL



### PCB LAYOUT, MOUNTING SIDE



### ELECTRICAL GRAPH



Hole	Ø	Without LED	Description	Terminal Section	Surface
	1,7 (.069)	2x	snap-in		
	1,6 (.062)	1x	coding hole (L,M,N)		
	1,1 (.043)	2x	center hole		Sn
	0,9 (.035)	2x	LED	m0.5 (.020)	Sn
	0,9 (.035)	2x	switch	0.7 x 0.2 (.028 x .081)	Sn



First Angle Projection



Key Switches

# K12 High Performance Key Switches

SERIES

**K12C** SEALED CONTACT WITH RUBBER CAP (IP 67)

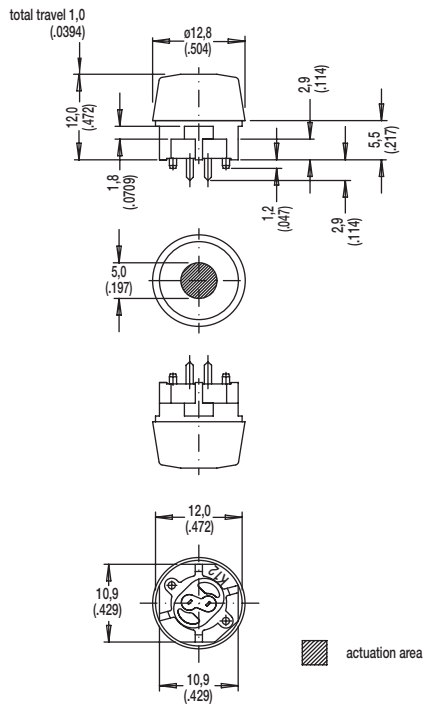

PCB LAYOUT, MOUNTING SIDE

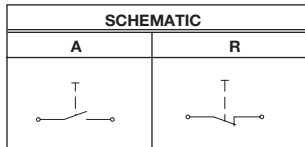
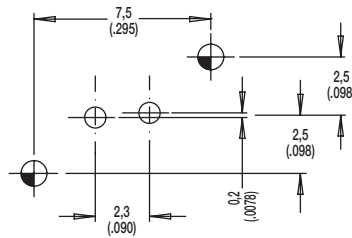

Hole	Ø	Without LED	Description	Terminal Section	Surface
	1,1 (.043)	2x	center hole		
	0,9 (.035)	2x	switch	0.7 x 0.2(.0275 x .0787)	Sn



D

Key Switches



First Angle  
Projection

Dimensions are shown: mm  
Specifications and dimensions subject to change

# K12 High Performance Key Switches

SERIES

## K12GO



### PCB LAYOUT, MOUNTING SIDE



Hole	Ø	Without LED	Description	Terminal Section	Surface
	1,7 (.069)	2x	snap-in		
	1,6 (.062)	1x	code		
	0,9 (.035)		LED	m0.5 (.020)	Sn
		2x	switch 2	0.7 x 0.3 (.028 x .012)	Sn
		2x	switch 1	0.7 x 0.2 (.028 x .081)	Sn



Dimensions are shown: mm  
Specifications and dimensions subject to change

# K12 High Performance Key Switches

## CAP COLOR

OPTION CODE	COLOR
<b>NONE</b>	Version with LED
<b>BK</b>	Black - no LED
<b>YE</b>	Yellow - no LED
<b>RD</b>	Red - no LED
<b>GY</b>	Gray - no LED

## LED COLOR

OPTION CODE	COLOR
<b>NONE</b>	Models without LED
<b>GN</b>	Green
<b>YE</b>	Yellow
<b>OG</b>	Orange
<b>RD</b>	Red
<b>WH</b>	White
<b>BU</b>	Blue

STANDARD LED CODE	COLOR
<b>NONE</b>	Models without LED
<b>LV306</b>	Green
<b>LV327</b>	Yellow
<b>LV315</b>	Orange
<b>LV352</b>	Red
<b>LV302</b>	White
<b>LV328</b>	Blue

## TRAVEL

- 1** 1 mm
- 1.5** 1.5 mm
- 2** 2 mm

## OPERATING FORCE

OPTION CODE	OPERATING FORCE
<b>1.5N OD</b>	1.5 N, 150g without snap-point
<b>2.5N</b>	2.5 N, 250g
<b>3.5N</b>	3.5 N, 350g
<b>5N</b>	5 N, 500g
<b>3.5/7N</b>	3.5/7 N, 350/700g
<b>6/12N</b>	6/12 N, 600-1200g

## CONTACT ARRANGEMENT OPTION

**1R** SPST NC (SPECIAL REQUEST FOR NORMALLY CLOSED OPTION)



First Angle  
Projection

Dimensions are shown: mm  
Specifications and dimensions subject to change

Компания «Life Electronics» занимается поставками электронных компонентов импортного и отечественного производства от производителей и со складов крупных дистрибьюторов Европы, Америки и Азии.

С конца 2013 года компания активно расширяет линейку поставок компонентов по направлению коаксиальный кабель, кварцевые генераторы и конденсаторы (керамические, пленочные, электролитические), за счёт заключения дистрибьюторских договоров

Мы предлагаем:

- Конкуренспособные цены и скидки постоянным клиентам.
- Специальные условия для постоянных клиентов.
- Подбор аналогов.
- Поставку компонентов в любых объемах, удовлетворяющих вашим потребностям.
- Приемлемые сроки поставки, возможна ускоренная поставка.
- Доставку товара в любую точку России и стран СНГ.
- Комплексную поставку.
- Работу по проектам и поставку образцов.
- Формирование склада под заказчика.
- Сертификаты соответствия на поставляемую продукцию (по желанию клиента).
- Тестирование поставляемой продукции.
- Поставку компонентов, требующих военную и космическую приемку.
- Входной контроль качества.
- Наличие сертификата ISO.

В составе нашей компании организован Конструкторский отдел, призванный помогать разработчикам, и инженерам.

Конструкторский отдел помогает осуществить:

- Регистрацию проекта у производителя компонентов.
- Техническую поддержку проекта.
- Защиту от снятия компонента с производства.
- Оценку стоимости проекта по компонентам.
- Изготовление тестовой платы монтаж и пусконаладочные работы.



Тел: +7 (812) 336 43 04 (многоканальный)  
Email: [org@lifeelectronics.ru](mailto:org@lifeelectronics.ru)