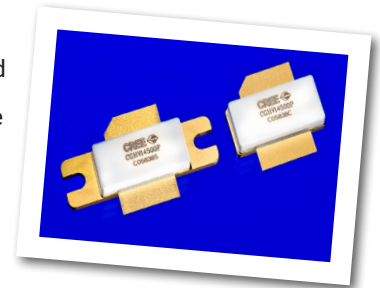


# CGHV14500

## 500 W, 1200 - 1400 MHz, GaN HEMT for L-Band Radar Systems

Cree's CGHV14500 is a gallium nitride (GaN) high electron mobility transistor (HEMT) designed specifically with high efficiency, high gain and wide bandwidth capabilities, which makes the CGHV14500 ideal for 1.2 - 1.4 GHz L-Band radar amplifier applications. The transistor could be utilized for band specific applications ranging from 800 through 1600 MHz. The package options are ceramic/metal flange and pill package.



Package Type: 440117, 440133  
PN: CGHV14500

### Typical Performance Over 1.2-1.4 GHz ( $T_c = 25^\circ\text{C}$ ) of Demonstration Amplifier

Parameter	1.2 GHz	1.25 GHz	1.3 GHz	1.35 GHz	1.4 GHz	Units
Output Power	545	540	530	530	530	W
Gain	16.4	16.3	16.2	16.2	16.2	dB
Drain Efficiency	69	69	68	66	65	%

**Note:**

Measured in the CGHV14500-AMP1 amplifier circuit, under 500  $\mu\text{s}$  pulse width, 10% duty cycle,  $P_{IN} = 41$  dBm.

### Features

- Reference design amplifier 1.2 - 1.4 GHz Operation
- FET tuning range UHF through 1800 MHz
- 530 W Typical Output Power
- 16 dB Power Gain
- 68% Typical Drain Efficiency
- <0.3 dB Pulsed Amplitude Droop
- Internally pre-matched on input, unmatched output

Large Signal Models Available for ADS and MWO

## Absolute Maximum Ratings (not simultaneous)

Parameter	Symbol	Rating	Units	Conditions
Drain-Source Voltage	$V_{DSS}$	125	Volts	25°C
Gate-to-Source Voltage	$V_{GS}$	-10, +2	Volts	25°C
Storage Temperature	$T_{STG}$	-65, +150	°C	
Operating Junction Temperature	$T_J$	225	°C	
Maximum Forward Gate Current	$I_{GMAX}$	84	mA	25°C
Maximum Drain Current <sup>1</sup>	$I_{DMAX}$	36	A	25°C
Soldering Temperature <sup>2</sup>	$T_s$	245	°C	
Screw Torque	$\tau$	40	in-oz	
CW Thermal Resistance, Junction to Case <sup>3</sup>	$R_{\theta JC}$	0.47	°C/W	$P_{DISS} = 334 \text{ W}, 65^\circ\text{C}$
Pulsed Thermal Resistance, Junction to Case <sup>3</sup>	$R_{\theta JC}$	0.28	°C/W	$P_{DISS} = 334 \text{ W}, 500 \mu\text{sec}, 10\%, 85^\circ\text{C}$
Pulsed Thermal Resistance, Junction to Case <sup>4</sup>	$R_{\theta JC}$	0.31	°C/W	$P_{DISS} = 334 \text{ W}, 500 \mu\text{sec}, 10\%, 85^\circ\text{C}$
Case Operating Temperature <sup>5</sup>	$T_C$	-40, +130	°C	$P_{DISS} = 334 \text{ W}, 500 \mu\text{sec}, 10\%$

### Note:

<sup>1</sup> Current limit for long term, reliable operation

<sup>2</sup> Refer to the Application Note on soldering at <http://www.cree.com/rf/document-library>

<sup>3</sup> Measured for the CGHV14500P

<sup>4</sup> Measured for the CGHV14500F

<sup>5</sup> See also, the Power Dissipation De-rating Curve on Page 5

## Electrical Characteristics

Characteristics	Symbol	Min.	Typ.	Max.	Units	Conditions
<b>DC Characteristics<sup>1</sup> (<math>T_C = 25^\circ\text{C}</math>)</b>						
Gate Threshold Voltage	$V_{GS(th)}$	-3.8	-3.0	-2.3	$V_{DC}$	$V_{DS} = 10 \text{ V}, I_D = 83.6 \text{ mA}$
Gate Quiescent Voltage	$V_{GS(Q)}$	-	-2.7	-	$V_{DC}$	$V_{DS} = 50 \text{ V}, I_D = 500 \text{ mA}$
Saturated Drain Current <sup>2</sup>	$I_{DS}$	62.7	75.2	-	A	$V_{DS} = 6.0 \text{ V}, V_{GS} = 2.0 \text{ V}$
Drain-Source Breakdown Voltage	$V_{BR}$	150	-	-	$V_{DC}$	$V_{GS} = -8 \text{ V}, I_D = 83.6 \text{ mA}$
<b>RF Characteristics<sup>3</sup> (<math>T_C = 25^\circ\text{C}, F_0 = 1.3 \text{ GHz}</math> unless otherwise noted)</b>						
Output Power	$P_{OUT}$	422	530	-	W	$V_{DD} = 50 \text{ V}, I_{DQ} = 500 \text{ mA}, P_{IN} = 41 \text{ dBm}$
Drain Efficiency	$D_E$	63	68	-	%	$V_{DD} = 50 \text{ V}, I_{DQ} = 500 \text{ mA}, P_{IN} = 41 \text{ dBm}$
Power Gain	$G_p$	15.25	16.2	-	dB	$V_{DD} = 50 \text{ V}, I_{DQ} = 500 \text{ mA}, P_{IN} = 41 \text{ dBm}$
Pulsed Amplitude Droop	D	-	-0.3	-	dB	$V_{DD} = 50 \text{ V}, I_{DQ} = 500 \text{ mA}$
Output Mismatch Stress	VSWR	-	5 : 1	-	$\Psi$	No damage at all phase angles, $V_{DD} = 50 \text{ V}, I_{DQ} = 500 \text{ mA}, P_{IN} = 41 \text{ dBm Pulsed}$

### Notes:

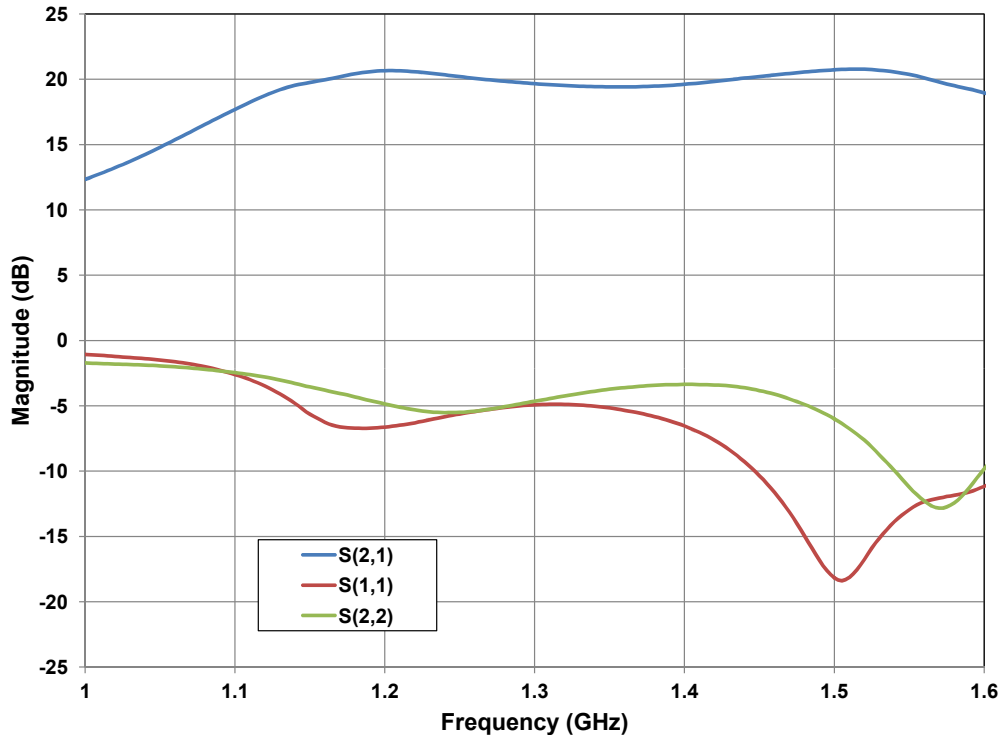
<sup>1</sup> Measured on wafer prior to packaging.

<sup>2</sup> Scaled from PCM data.

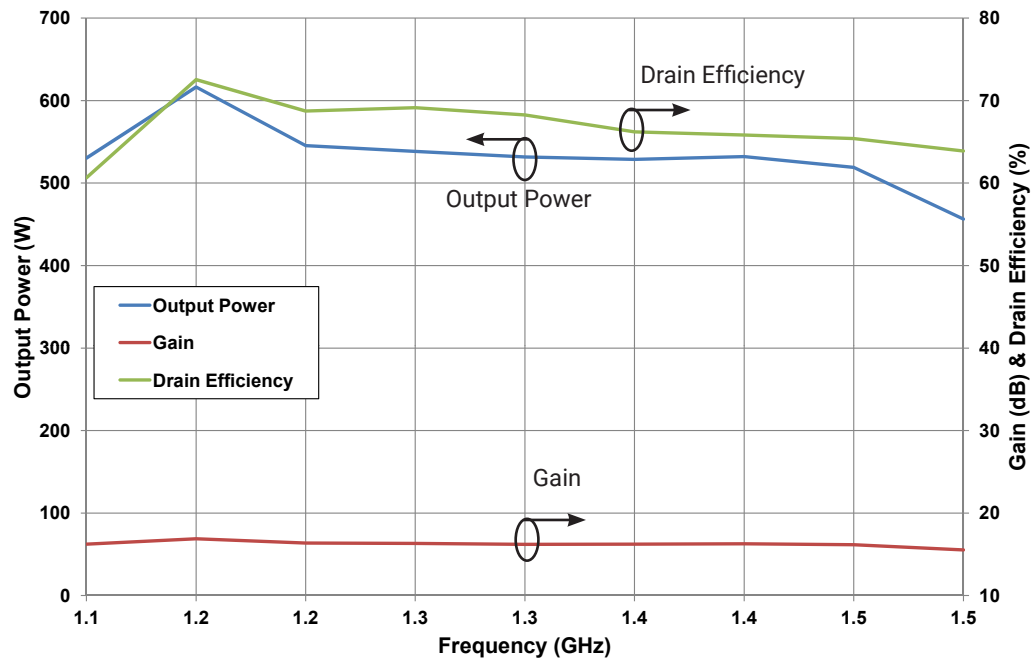
<sup>3</sup> Measured in CGHV14500-AMP1. Pulse Width = 500  $\mu\text{s}$ , Duty Cycle = 10%.

## Typical Performance

**Figure 1. - CGHV14500 Typical Sparmeters**  
 $V_{DD} = 50\text{ V}, I_{DQ} = 500\text{ mA}$



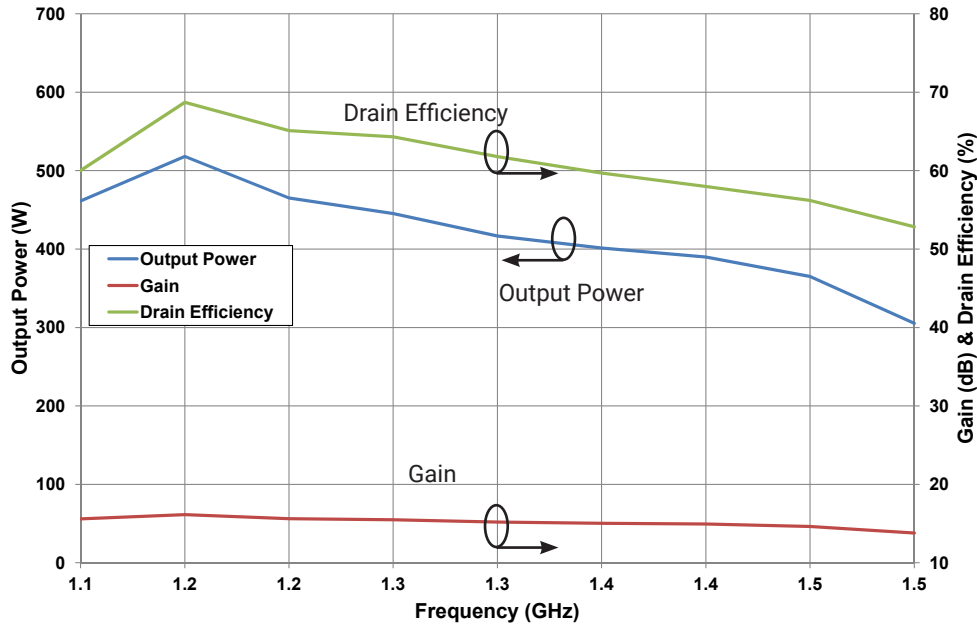
**Figure 2. - CGHV14500 Typical RF Results**  
 $V_{DD} = 50\text{ V}, I_{DQ} = 500\text{ mA}, P_{IN} = 41\text{ dBm}$   
 $T_{case} = 25^\circ\text{C}, \text{Pulse Width} = 500\ \mu\text{s}, \text{Duty Cycle} = 10\%$



## Typical Performance

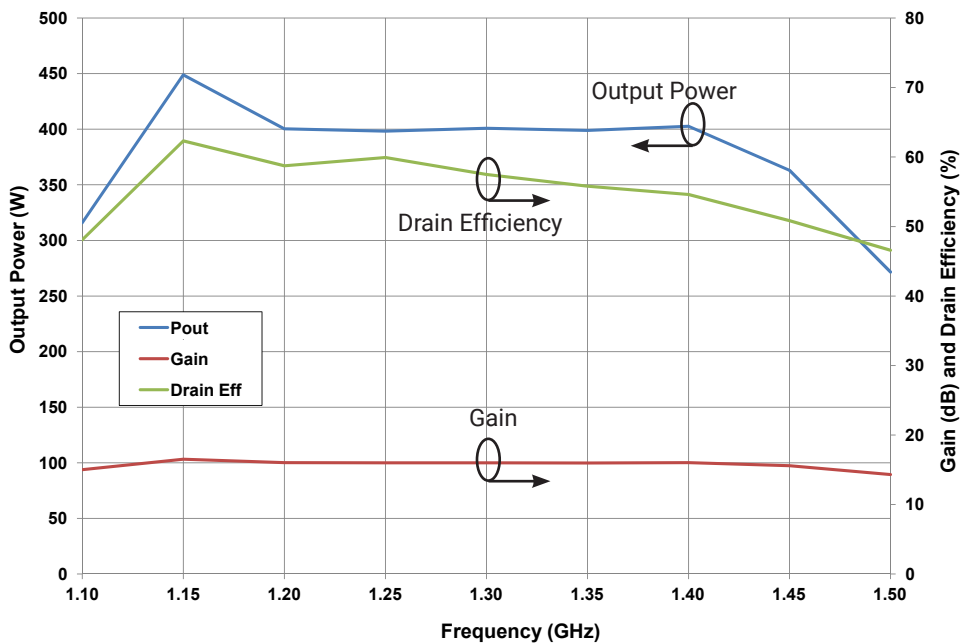
**Figure 3. - CGHV14500 Typical RF Results**

$V_{DD} = 50\text{ V}$ ,  $I_{DQ} = 500\text{ mA}$ ,  $P_{IN} = 41\text{ dBm}$   
 $T_{case} = 85^\circ\text{C}$ , Pulse Width =  $500\ \mu\text{s}$ , Duty Cycle = 10 %

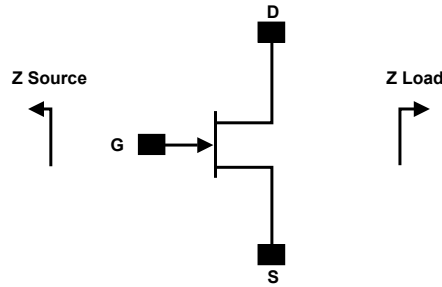


**Figure 4. - CGHV14500 Typical CW RF Results**

$V_{DD} = 50\text{ V}$ ,  $I_{DQ} = 500\text{ mA}$ ,  $P_{IN} = 40\text{ dBm}$ ,  $T_{case} = 50^\circ\text{C}$



## Source and Load Impedances



Frequency (MHz)	Z Source	Z Load
900	0.3 - j0.3	2.1 + j1.4
1000	0.3 - j0.4	2.0 + j0.7
1100	0.6 - j0.4	1.8 + j0.9
1200	0.8 - j0.7	1.5 + j0.9
1300	1.1 - j0.7	1.3 + j0.7
1400	1.2 - j0.1	1.2 + j0.5
1500	1.8 - j0.1	1.1 + j0.4

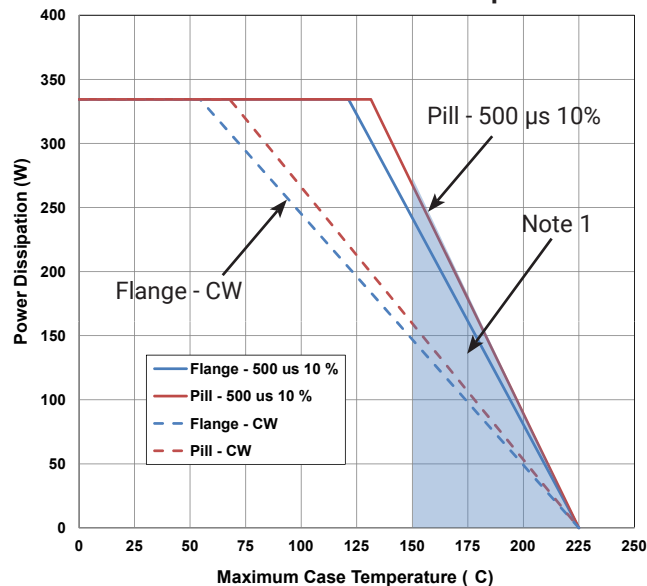
Note 1.  $V_{DD} = 50\text{ V}$ ,  $I_{DQ} = 500\text{ mA}$  in the 440117 package

Note 2. Optimized for power gain,  $P_{SAT}$  and Drain Efficiency

Note 3. When using this device at low frequency, series resistors should be used to maintain amplifier stability

## CGHV14500 Power Dissipation De-rating Curve

Figure 5. - CGHV14500 Transient Power Dissipation De-Rating Curve

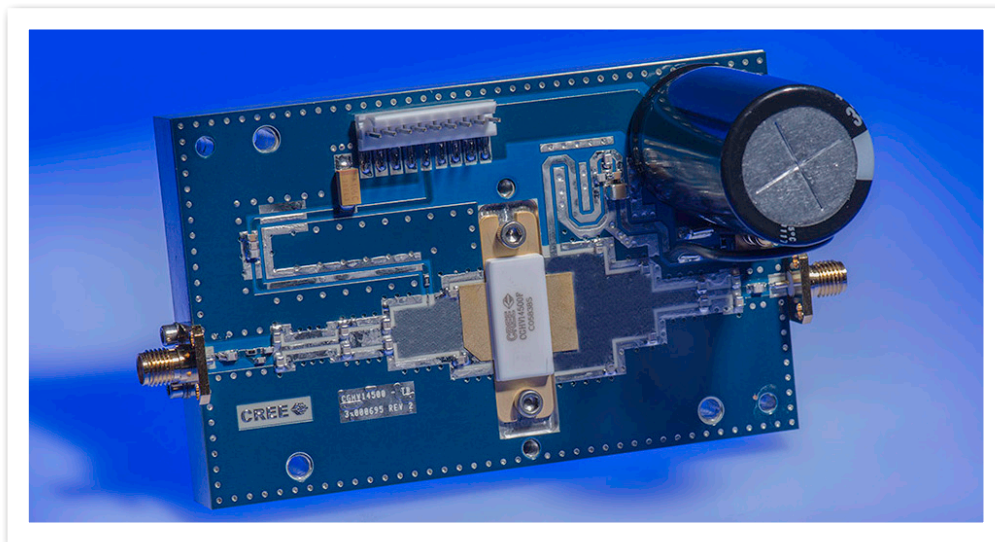


Note 1. Area exceeds Maximum Case Temperature (See Page 2).

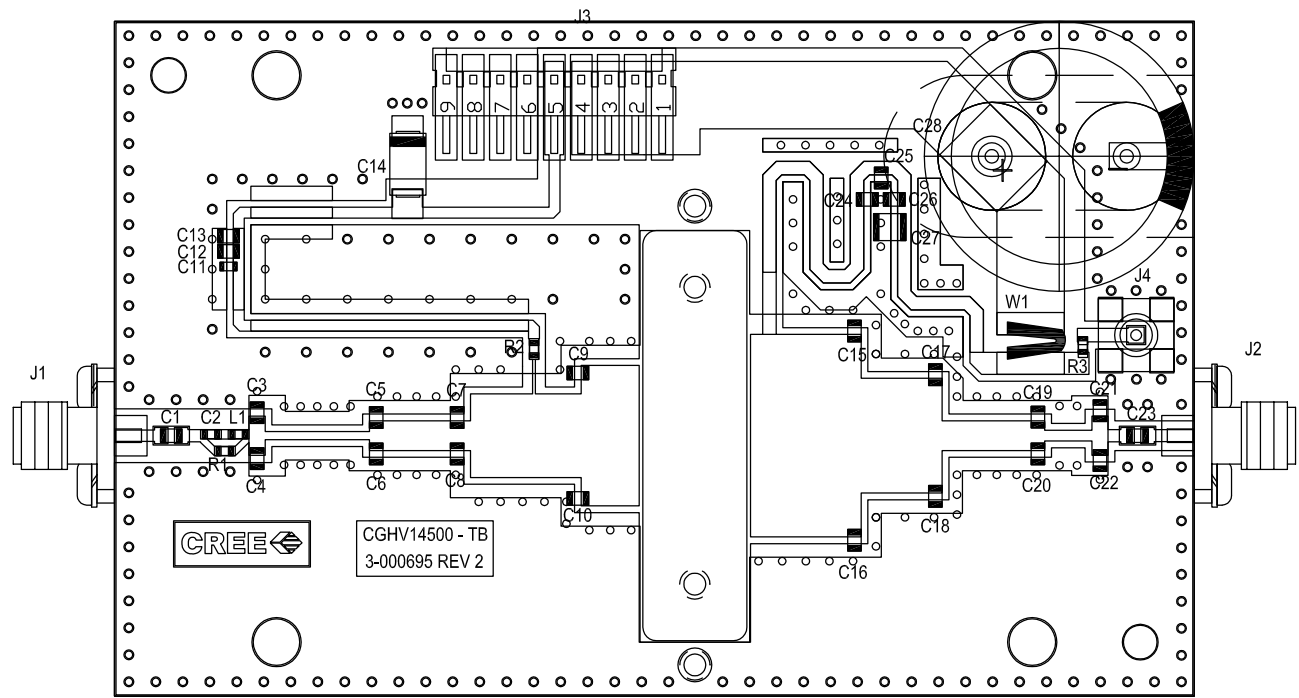
## CGHV14500-AMP1 Demonstration Amplifier Circuit Bill of Materials

Designator	Description	Qty
R1	RES, 1/16W, 0603, 1%, 562 OHMS	1
R2	RES, 5.1 OHM, +/-1%, 1/16W, 0603	1
R3	RES, 1/16W, 0603, 1%, 4700 OHMS	1
L1	INDUCTOR, CHIP, 6.8 nH, 0603 SMT	1
C1, C23	CAP, 27pF, +/- 5%, 250V, 0805, ATC 600F	2
C2	CAP, 2.0pF, +/- 0.1pF, 0603, ATC	1
C3, C4	CAP, 1.5pF, +/-0.05pF, 250V, 0805, ATC 600F	2
C5,C6	CAP, 1.8pF, +/-0.1pF, 250V, 0805, ATC 600F	2
C7,C8	CAP, 4.3pF, +/-0.1pF, 250V, 0805, ATC 600F	2
C9,C10	CAP, 7.5pF, +/-0.1pF, 250V, 0805, ATC 600F	2
C11,C24	CAP, 47pF,+/-5%, 250V, 0805, ATC 600F	2
C12,C25	CAP, 100pF, +/-5%, 250V, 0805, ATC 600F	2
C13,C26	CAP, 33000PF, 0805,100V, X7R	2
C14	CAP 10uF 16V TANTALUM	1
C15,C16	CAP, 5.6pF, +/-0.1pF, 250V, 0805, ATC 600F	2
C17,C18	CAP, 3.6pF, +/-0.1pF, 250V, 0805, ATC 600F	2
C19,C20	CAP, 2.0pF, +/-0.1pF, 250V, 0805, ATC 600F	2
C21,C22	CAP, 0.7pF, +/-0.05pF, 0805, ATC 600F	2
C27	CAP, 1.0UF, 100V, 10%, X7R, 1210	1
C28	CAP, 3300 UF, +/-20%, 100V, ELECTROLYTIC	1
J1,J2	CONN, SMA, PANEL MOUNT JACK, FL	2
J3	HEADER RT>PLZ .1CEN LK 9POS	1
J4	CONNECTOR ; SMB, Straight, JACK,SMD	1
W1	CABLE ,18 AWG, 4.2	1
	PCB, RO4350B, 0.020' MIL THK, CGHV14500, 1.2-1.4GHZ	1
Q1	CGHV14500	1

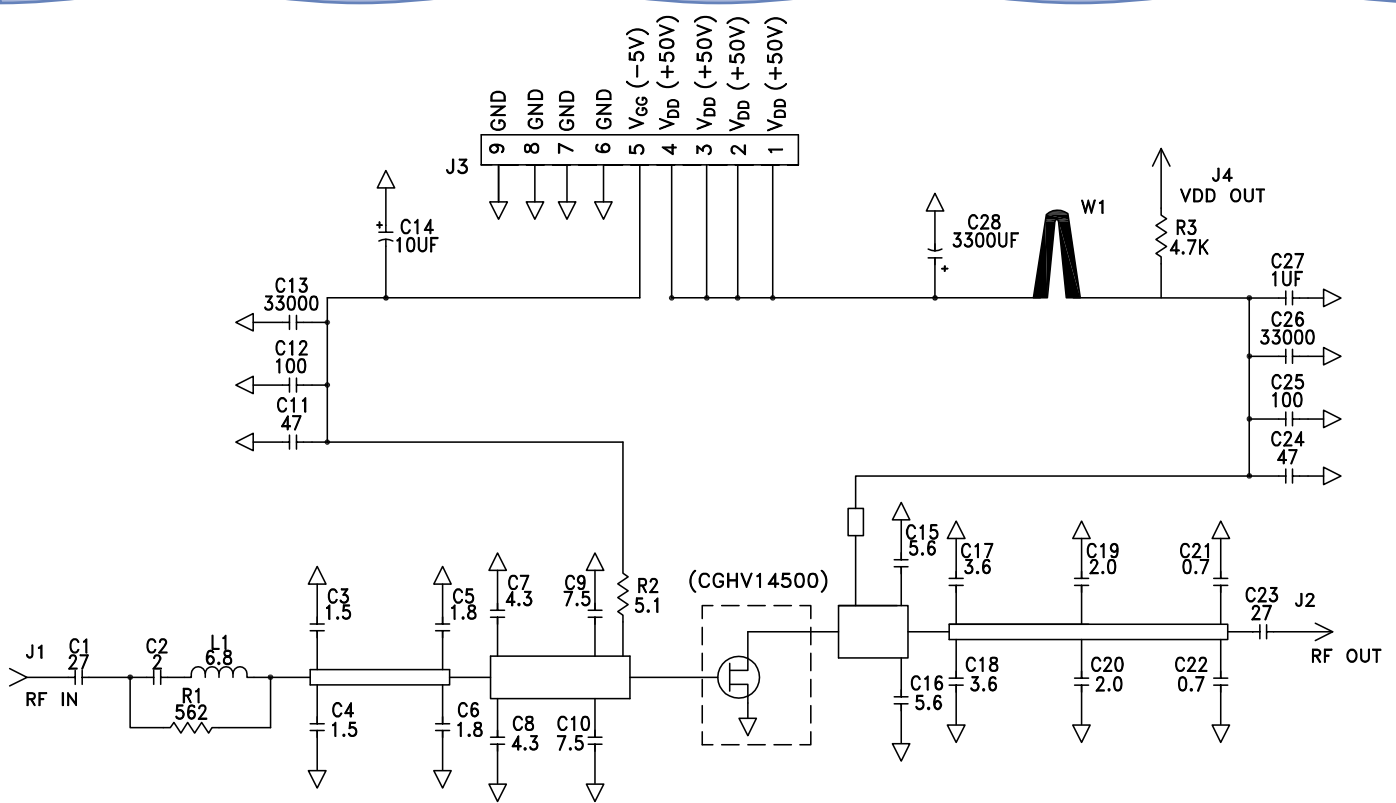
## CGHV14500-AMP1 Demonstration Amplifier Circuit



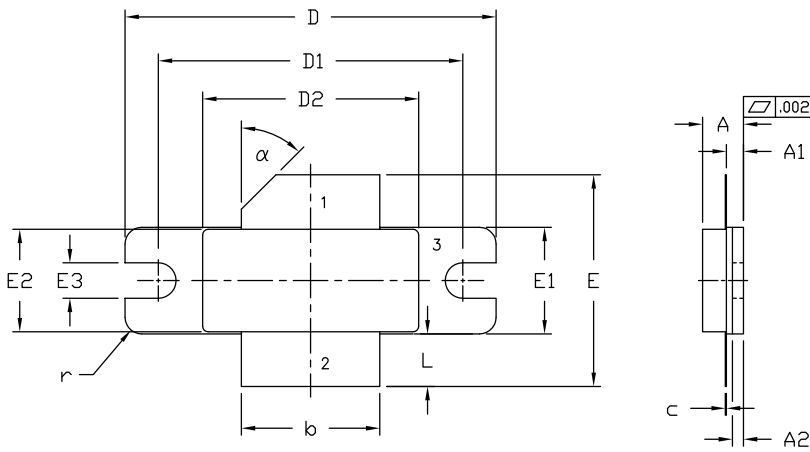
## CGHV14500-AMP1 Demonstration Amplifier Circuit Outline



## CGHV14500-AMP1 Demonstration Amplifier Circuit Schematic



## Product Dimensions CGHV14500F (Package Type – 440117)



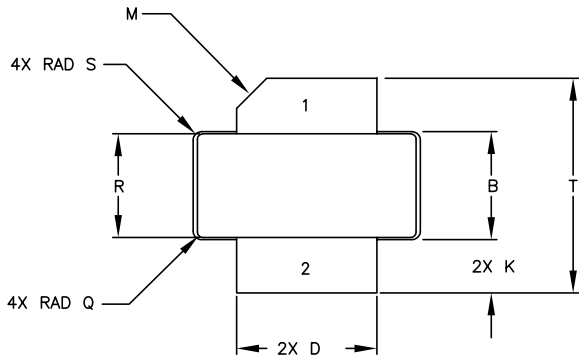
PIN 1. GATE  
2. DRAIN  
3. SOURCE

**NOTES:**

1. DIMENSIONING AND TOLERANCING PER ANSI Y14.5M - 1994.
2. CONTROLLING DIMENSION: INCH.
3. ADHESIVE FROM LID MAY EXTEND A MAXIMUM OF 0.020" BEYOND EDGE OF LID.
4. LID MAY BE MISALIGNED TO THE BODY OF PACKAGE BY A MAXIMUM OF 0.008" IN ANY DIRECTION.

DIM	INCHES		MILLIMETERS		NOTES
	MIN	MAX	MIN	MAX	
A	0.138	0.158	3.51	4.01	
A1	0.057	0.067	1.45	1.70	
A2	0.035	0.045	0.89	1.14	
b	0.495	0.505	12.57	12.83	2x
c	0.003	0.006	0.08	0.15	
D	1.335	1.345	33.91	34.16	
D1	1.095	1.105	27.81	28.07	
D2	0.773	0.787	19.63	20.00	
E	0.745	0.785	18.92	19.94	
E1	0.380	0.390	9.65	9.91	
E2	0.365	0.375	9.72	9.53	
E3	0.123	0.133	3.12	3.38	
L	0.170	0.210	4.32	5.33	2x
r	0.06 TYP		0.06 TYP		4x
α	45° REF		45° REF		

## Product Dimensions CGHV14500P (Package Type – 440133)



**NOTES:**

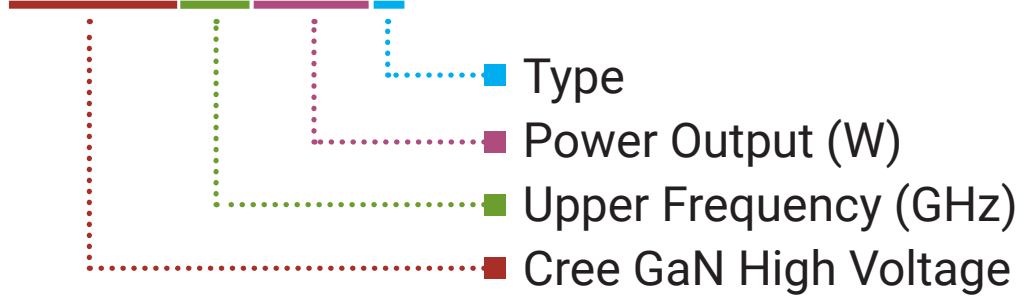
1. DIMENSIONING AND TOLERANCING PER ANSI Y14.5M, 1982.
2. CONTROLLING DIMENSION: INCH.
3. ADHESIVE FROM LID MAY EXTEND A MAXIMUM OF 0.020" BEYOND EDGE OF LID.
4. LID MAY BE MISALIGNED TO THE BODY OF PACKAGE BY A MAXIMUM OF 0.008" IN ANY DIRECTION.

DIM	INCHES		MILLIMETERS	
	MIN	MAX	MIN	MAX
A	0.805	0.815	20.45	20.70
B	0.380	0.390	9.65	9.91
C	0.135	0.149	3.43	3.78
D	0.495	0.505	12.57	12.83
E	0.035	0.045	.89	1.14
H	0.057	0.067	1.45	1.70
J	0.003	0.006	.08	.15
K	0.170	0.210	4.32	5.33
M	45° REF		45° REF	
N	0.773	0.787	19.63	19.99
Q	0.020 REF		0.51 REF	
R	0.364	0.374	9.25	9.50
S	0.030 REF		0.76 REF	
T	0.745	0.785	18.92	19.94

STYLE 1:  
PIN 1. GATE  
2. DRAIN  
3. SOURCE



### CGHV14500F



Parameter	Value	Units
Upper Frequency <sup>1</sup>	1.4	GHz
Power Output	500	W
Type	F = Flanged P = Package	-

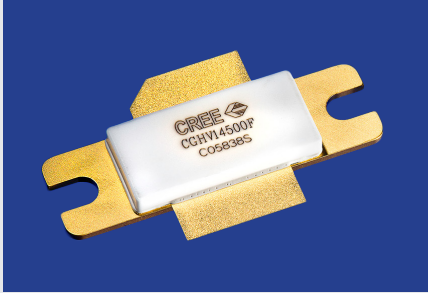
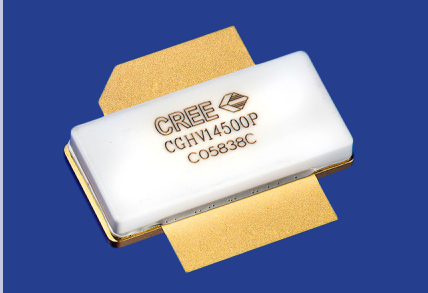
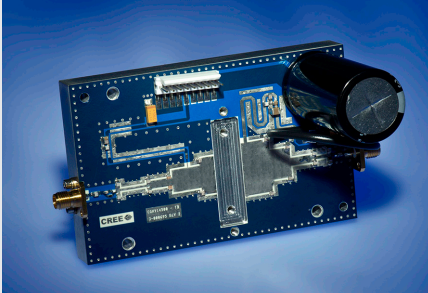
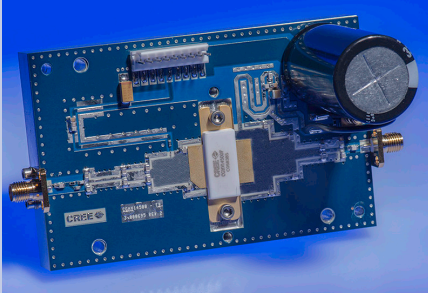
**Table 1.**

**Note<sup>1</sup>:** Alpha characters used in frequency code indicate a value greater than 9.9 GHz. See Table 2 for value.

Character Code	Code Value
A	0
B	1
C	2
D	3
E	4
F	5
G	6
H	7
J	8
K	9
Examples:	1A = 10.0 GHz 2H = 27.0 GHz

**Table 2.**

## Product Ordering Information

Order Number	Description	Unit of Measure	Image
CGHV14500F	GaN HEMT	Each	
CGHV14500P	GaN HEMT	Each	
CGHV14500v-TB	Test board without GaN HEMT	Each	
CGHV14500F-AMP1	Test board with GaN HEMT installed	Each	



## Disclaimer

Specifications are subject to change without notice. Cree, Inc. believes the information contained within this data sheet to be accurate and reliable. However, no responsibility is assumed by Cree for any infringement of patents or other rights of third parties which may result from its use. No license is granted by implication or otherwise under any patent or patent rights of Cree. Cree makes no warranty, representation or guarantee regarding the suitability of its products for any particular purpose. "Typical" parameters are the average values expected by Cree in large quantities and are provided for information purposes only. These values can and do vary in different applications and actual performance can vary over time. All operating parameters should be validated by customer's technical experts for each application. Cree products are not designed, intended or authorized for use as components in applications intended for surgical implant into the body or to support or sustain life, in applications in which the failure of the Cree product could result in personal injury or death or in applications for planning, construction, maintenance or direct operation of a nuclear facility.

For more information, please contact:

Cree, Inc.  
4600 Silicon Drive  
Durham, North Carolina, USA 27703  
[www.cree.com/rf](http://www.cree.com/rf)

Sarah Miller  
Marketing  
Cree, RF Components  
1.919.407.5302

Ryan Baker  
Marketing & Sales  
Cree, RF Components  
1.919.407.7816

Tom Dekker  
Sales Director  
Cree, RF Components  
1.919.407.5639

Компания «Life Electronics» занимается поставками электронных компонентов импортного и отечественного производства от производителей и со складов крупных дистрибьюторов Европы, Америки и Азии.

С конца 2013 года компания активно расширяет линейку поставок компонентов по направлению коаксиальный кабель, кварцевые генераторы и конденсаторы (керамические, пленочные, электролитические), за счёт заключения дистрибьюторских договоров

Мы предлагаем:

- Конкуренспособные цены и скидки постоянным клиентам.
- Специальные условия для постоянных клиентов.
- Подбор аналогов.
- Поставку компонентов в любых объемах, удовлетворяющих вашим потребностям.
- Приемлемые сроки поставки, возможна ускоренная поставка.
- Доставку товара в любую точку России и стран СНГ.
- Комплексную поставку.
- Работу по проектам и поставку образцов.
- Формирование склада под заказчика.
- Сертификаты соответствия на поставляемую продукцию (по желанию клиента).
- Тестирование поставляемой продукции.
- Поставку компонентов, требующих военную и космическую приемку.
- Входной контроль качества.
- Наличие сертификата ISO.

В составе нашей компании организован Конструкторский отдел, призванный помогать разработчикам, и инженерам.

Конструкторский отдел помогает осуществить:

- Регистрацию проекта у производителя компонентов.
- Техническую поддержку проекта.
- Защиту от снятия компонента с производства.
- Оценку стоимости проекта по компонентам.
- Изготовление тестовой платы монтаж и пусконаладочные работы.



Тел: +7 (812) 336 43 04 (многоканальный)

Email: [org@lifeelectronics.ru](mailto:org@lifeelectronics.ru)