



LIGHTING FOREVER

# 6 PIN DIP PHOTOTRANSISTOR PHOTOCOUPLER

# CNY17-X Series CNY17F-X Series

## Features

- Current transfer ratios in selected narrow range groups  
 CNY17-1, CNY17F-1: 40-80%  
 CNY17-2, CNY17F-2: 63-125%  
 CNY17-3, CNY17F-3: 100-200%  
 CNY17-4, CNY17F-4:160-320%
- High isolation voltage between input and output  
 (Viso = 5000 Vrms)
- Creepage distance > 7.6 mm
- Operating temperature up to +110°C
- The CNY17F-X series offers no external base connection  
 for minimum noise susceptibility
- Compact dual-in-line package
- Pb free and RoHS compliant.
- UL approved (No. E214129)
- VDE approved (No. 132249)
- SEMKO approved
- NEMKO approved
- DEMKO approved
- FIMKO approved
- CSA approved

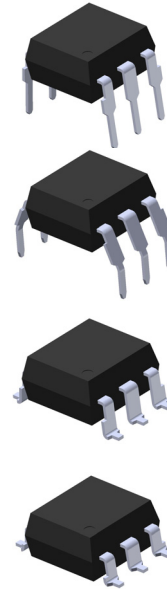

## Schematic

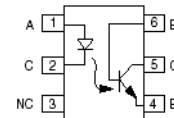

CNY17-X

1. Anode
2. Cathode
3. No Connection
4. Emitter
5. Collector
6. Base

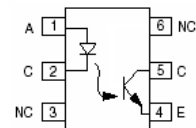

CNY17F-X

1. Anode
2. Cathode
3. No Connection
4. Emitter
5. Collector
6. No Connection

## Description

The CNY17-X and CNY17F-X series of devices each consist of an infrared emitting diode optically coupled to a phototransistor.

It is packaged in a 6-pin DIP package and available in wide-lead spacing and SMD option.

## Applications

- Power supply regulators
- Digital logic inputs
- Microprocessor inputs



LIGHTING FOREVER

# 6 PIN DIP PHOTOTRANSISTOR PHOTOCOUPLER

# CNY17-X Series CNY17F-X Series

## Absolute Maximum Ratings ( $T_a=25^{\circ}\text{C}$ )

Parameter		Symbol	Rating	Unit
Input	Forward current	$I_F$	60	mA
	Peak forward current ( $t = 10\mu\text{s}$ )	$I_{FM}$	1	A
	Reverse voltage	$V_R$	6	V
	Power dissipation ( $T_A = 25^{\circ}\text{C}$ )	$P_D$	100	mW
	Derating factor (above $100^{\circ}\text{C}$ )		3.8	mW/ $^{\circ}\text{C}$
Output	Collector-Emitter voltage	$V_{CEO}$	80	V
	Collector-Base voltage <sup>*1</sup>	$V_{CBO}$	80	V
	Collector current	$I_C$	50	mA
	Emitter-Collector voltage	$V_{ECO}$	7	V
	Power dissipation ( $T_A = 25^{\circ}\text{C}$ )	$P_C$	150	mW
Derating factor (above $100^{\circ}\text{C}$ )	9.0		mW/ $^{\circ}\text{C}$	
Total power dissipation		$P_{tot}$	200	mW
Isolation voltage <sup>*2</sup>		$V_{iso}$	5000	Vrms
Operating temperature		$T_{opr}$	-55~+110	$^{\circ}\text{C}$
Storage temperature		$T_{stg}$	-55~+125	$^{\circ}\text{C}$
Soldering temperature <sup>*3</sup>		$T_{sol}$	260	$^{\circ}\text{C}$

### Notes

\*1 Only for CNY17-X series.

\*2 AC for 1 minute, R.H.= 40 ~ 60% R.H. In this test, pins 1, 2 & 3 are shorted together, and pins 4, 5 & 6 are shorted together.

\*3 For 10 seconds.



LIGHTING FOREVER

## 6 PIN DIP PHOTOTRANSISTOR PHOTOCOUPLER

## CNY17-X Series CNY17F-X Series

### Electrical Characteristics ( $T_a=25^\circ\text{C}$ unless specified otherwise)

#### Input

Parameter	Symbol	Min.	Typ.*	Max.	Unit	Condition
Forward voltage	$V_F$	-	-	1.65	V	$I_F = 60\text{mA}$
Reverse current	$I_R$	-	-	10	$\mu\text{A}$	$V_R = 6\text{V}$
Input capacitance	$C_{in}$	-	18	-	pF	$V = 0, f = 1\text{MHz}$

#### Output

Parameter	Symbol	Min.	Typ.*	Max.	Unit	Condition
Collector-Base dark current	CNY17-X only $I_{CBO}$	-	-	20	nA	$V_{CB} = 10\text{V}, I_F = 0\text{mA}$
Collector-Emitter dark current	$I_{CEO}$	-	-	50	nA	$V_{CE} = 10\text{V}, I_F = 0\text{mA}$
Collector-Emitter breakdown voltage	$BV_{CEO}$	80	-	-	V	$I_C = 1\text{mA}, I_F = 0\text{mA}$
Collector-Base breakdown voltage	CNY17-X only $BV_{CBO}$	80	-	-	V	$I_C = 0.1\text{mA}, I_F = 0\text{mA}$
Emitter-Collector breakdown voltage	$BV_{ECO}$	7	-	-	V	$I_E = 0.1\text{mA}, I_F = 0\text{mA}$
Collector-Emitter capacitance	$C_{CE}$	-	8	-	pF	$V_{CE} = 0\text{V}, f = 1\text{MHz}$

\* Typical values at  $T_a = 25^\circ\text{C}$



LIGHTING FOREVER

# 6 PIN DIP PHOTOTRANSISTOR PHOTOCOUPLER

# CNY17-X Series CNY17F-X Series

Transfer Characteristics ( $T_a=25^{\circ}\text{C}$  unless specified otherwise)

Parameter		Symbol	Min.	Typ.*	Max.	Unit	Condition
Current Transfer Ratio	CNY17-1 CNY17F-1	CTR	40	-	80	%	$I_F = 10\text{mA}, V_{CE} = 5\text{V}$
	CNY17-2 CNY17F-2		63	-	125		
	CNY17-3 CNY17F-3		100	-	200		
	CNY17-4 CNY17F-4		160	-	320		
Current Transfer Ratio	CNY17-1 CNY17F-1	CTR	13	-	-	%	$I_F = 1\text{mA}, V_{CE} = 5\text{V}$
	CNY17-2 CNY17F-2		22	-	-		
	CNY17-3 CNY17F-3		34	-	-		
	CNY17-4 CNY17F-4		56	-	-		
Collector-Emitter saturation voltage		$V_{CE(sat)}$	-	-	0.3	V	$I_F = 10\text{mA}, I_C = 2.5\text{mA}$
Isolation resistance		$R_{IO}$	$10^{11}$	-	-	$\Omega$	$V_{IO} = 500\text{Vdc}$
Input-output capacitance		$C_{IO}$	-	0.5	-	pF	$V_{IO} = 0, f = 1\text{MHz}$
Turn-on time		$T_{on}$	-	10	12	$\mu\text{s}$	$V_{CC} = 10\text{V}, I_C = 2\text{mA}, R_L = 100\Omega$ See Fig. 11
Turn-off time		$T_{off}$	-	9	12		
Rise time		$T_r$	-	6	10		
Fall time		$T_f$	-	8	10		
Rise time		$T_r$	-	2	10		$V_{CC} = 5\text{V}, I_F = 10\text{mA}, R_L = 75\Omega$ , See Fig. 11
Fall time		$T_f$	-	3	10		

\* Typical values at  $T_a = 25^{\circ}\text{C}$



LIGHTING FOREVER

# 6 PIN DIP PHOTOTRANSISTOR PHOTOCOUPLER

# CNY17-X Series CNY17F-X Series

## Typical Performance Curves

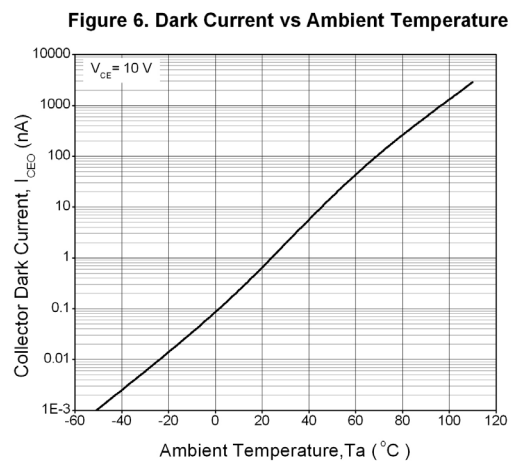
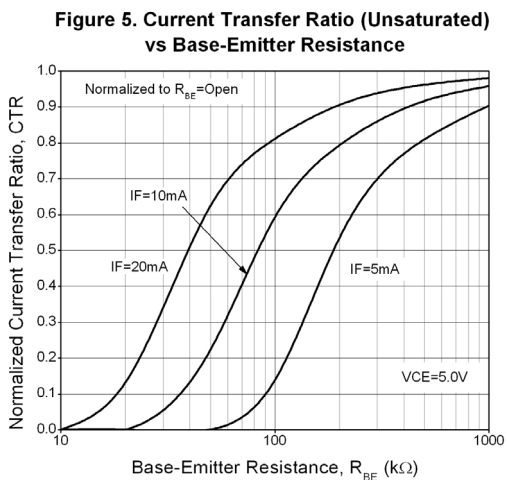
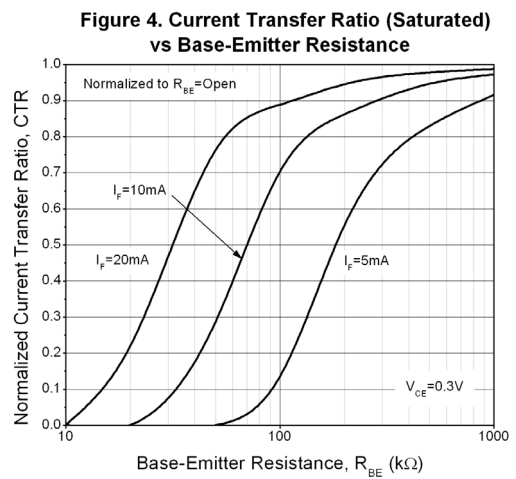
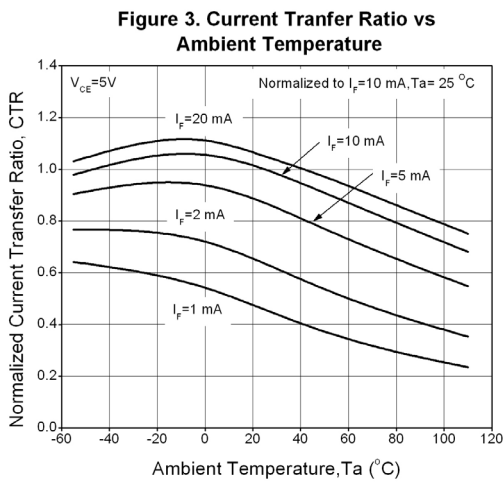
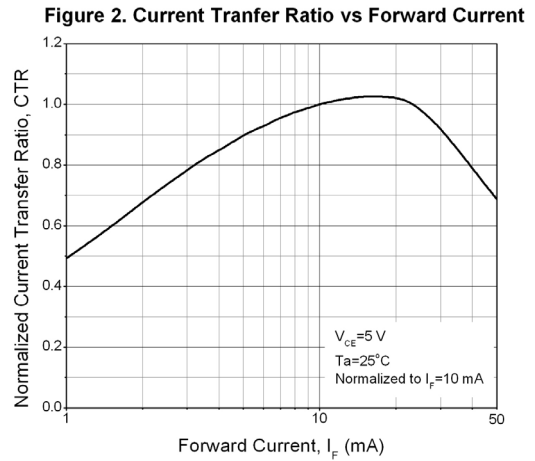
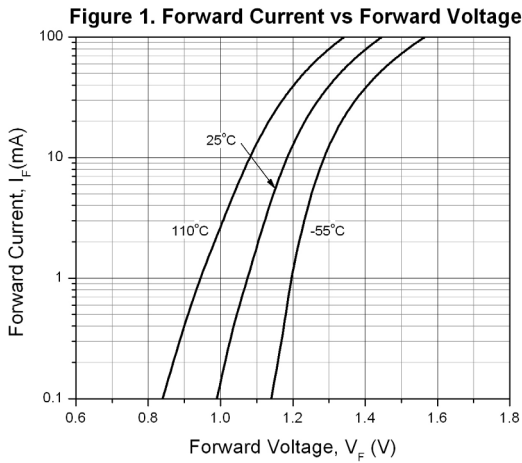

# 6 PIN DIP PHOTOTRANSISTOR PHOTOCOUPLER

# CNY17-X Series CNY17F-X Series

**Figure 7. Collector-Emitter Saturation Voltage vs Collector Current**

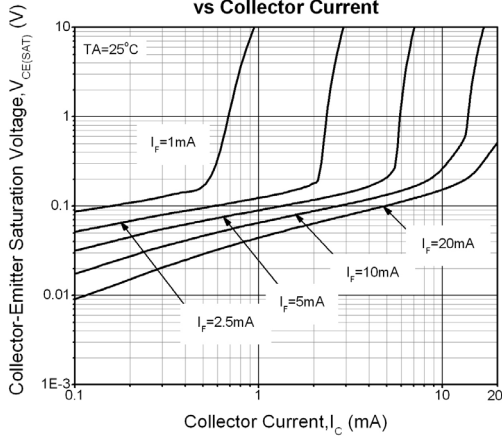

**Figure 8. Switching Time vs Load Resistance**

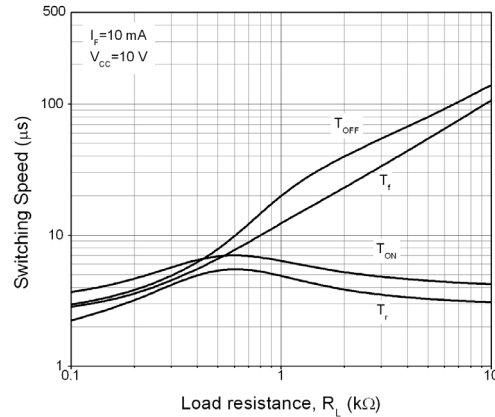

**Figure 9. Turn-on Time vs Base-Emitter Resistance**

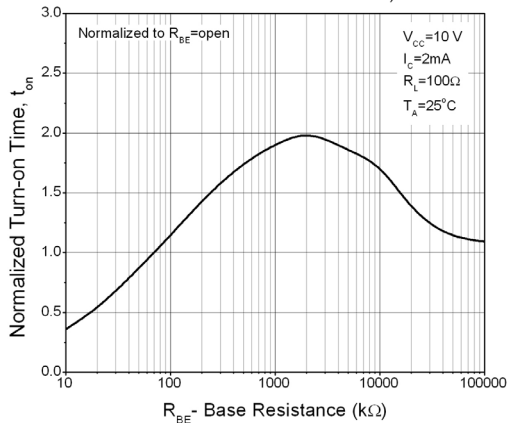

**Figure 10. Turn-off Time vs Base-Emitter Resistance**

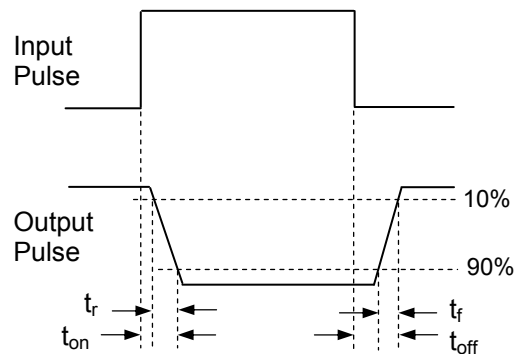
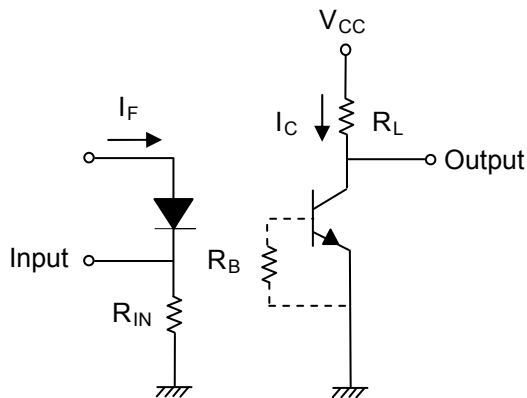
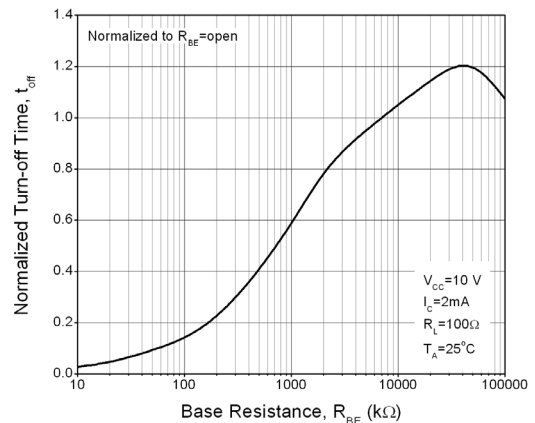

**Figure 11. Switching Time Test Circuit & Waveforms**



LIGHTING FOREVER

# 6 PIN DIP PHOTOTRANSISTOR PHOTOCOUPLER

**CNY17-X Series**  
**CNY17F-X Series**

## Order Information

### Part Number

**CNY17-XY(Z)-V**

or

**CNY17F-XY(Z)-V**

### Note

- X = Part no. (1, 2, 3 or 4)
- Y = Lead form option (S, S1, M or none)
- Z = Tape and reel option (TA, TB or none).
- V = VDE (optional)

Option	Description	Packing quantity
None	Standard DIP-6	65 units per tube
M	Wide lead bend (0.4 inch spacing)	65 units per tube
S (TA)	Surface mount lead form + TA tape & reel option	1000 units per reel
S (TB)	Surface mount lead form + TB tape & reel option	1000 units per reel
S1 (TA)	Surface mount lead form (low profile) + TA tape & reel option	1000 units per reel
S1 (TB)	Surface mount lead form (low profile) + TB tape & reel option	1000 units per reel



LIGHTING FOREVER

# 6 PIN DIP PHOTOTRANSISTOR PHOTOCOUPLER

## CNY17-X Series CNY17F-X Series

### Package Drawings

(Dimensions in mm)

#### Standard DIP Type

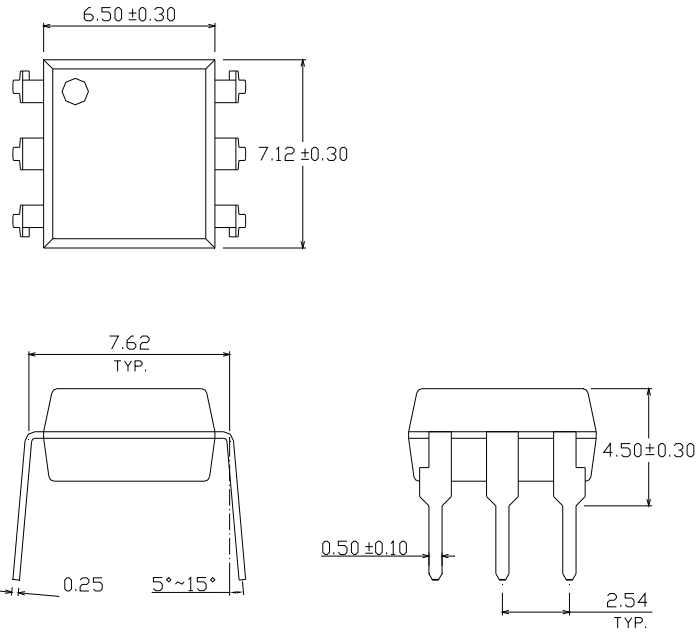

#### Option M Type

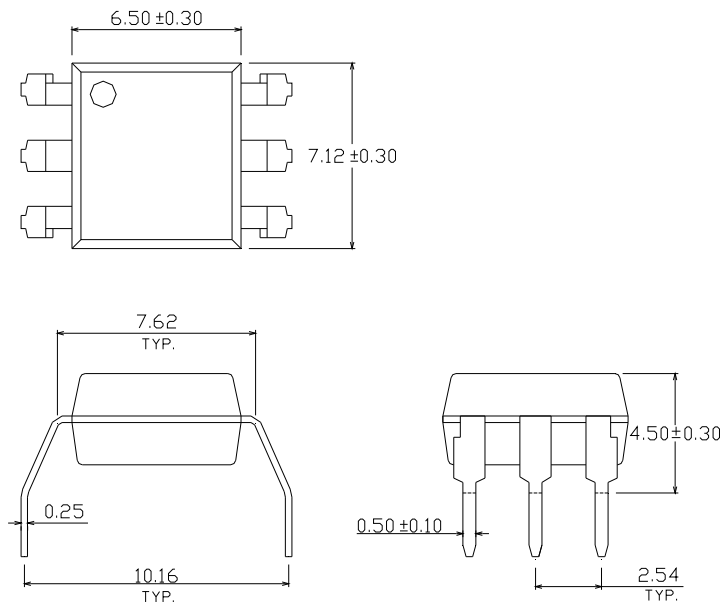





LIGHTING FOREVER

# 6 PIN DIP PHOTOTRANSISTOR PHOTOCOUPLER

## CNY17-X Series CNY17F-X Series

### Option S Type

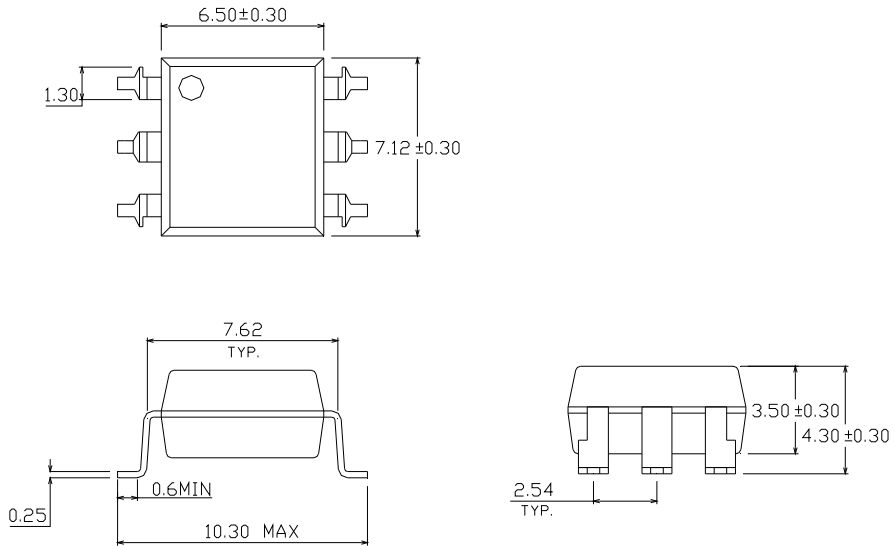

### Option S1 Type

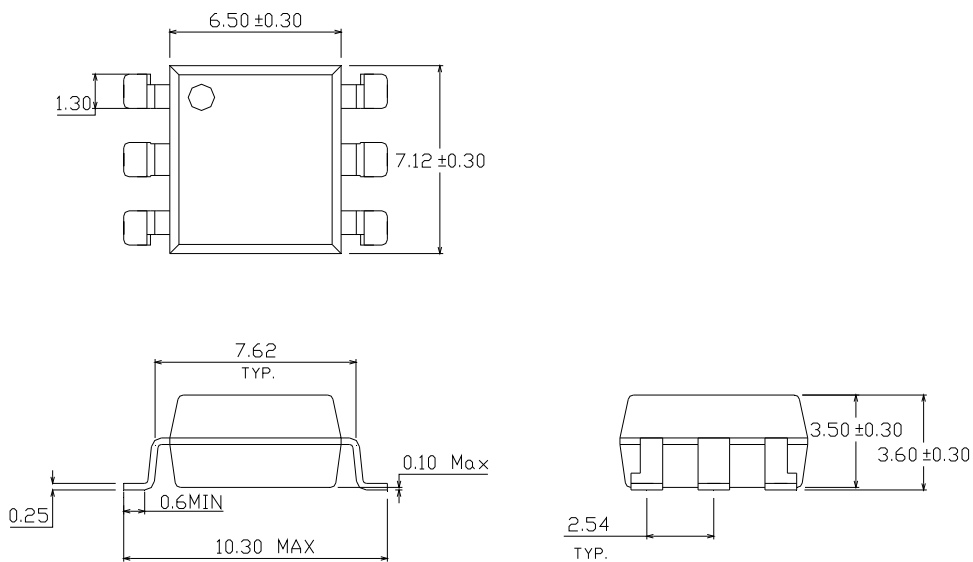



LIGHTING FOREVER

# 6 PIN DIP PHOTOTRANSISTOR PHOTOCOUPLER

## CNY17-X Series CNY17F-X Series

### Recommended pad layout for surface mount leadform

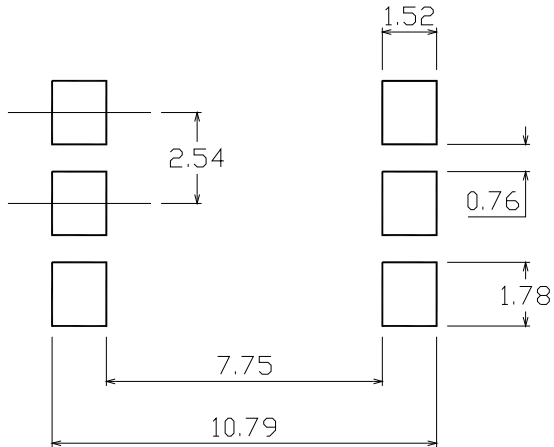

### Device Marking

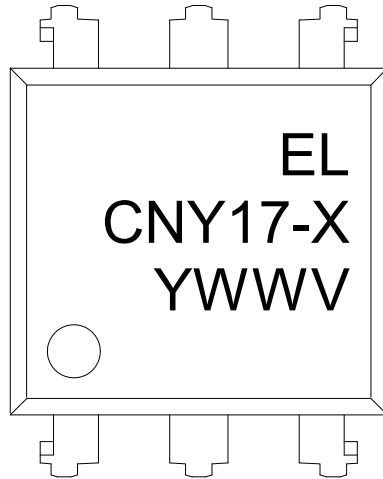

### Notes

- EL denotes Everlight
- CNY17-X denotes Device Number (X: 1, 2, 3 or 4)
- Y denotes 1 digit Year code
- WW denotes 2 digit Week code
- V denotes VDE (optional)



LIGHTING FOREVER

# 6 PIN DIP PHOTOTRANSISTOR PHOTOCOUPLER

# CNY17-X Series CNY17F-X Series

## Tape & Reel Packing Specifications

**Option TA**

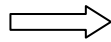
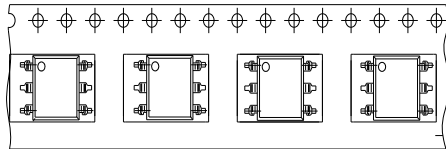

Direction of feed from reel

**Option TB**

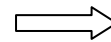
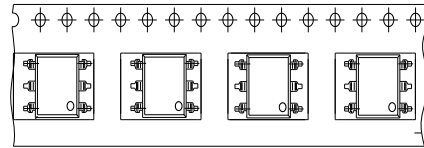

Direction of feed from reel

## Tape dimensions

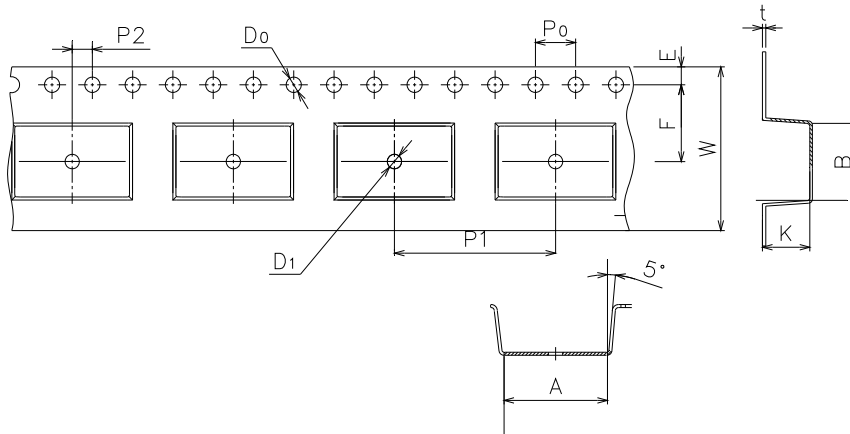

Dimension No.	A	B	Do	D1	E	F
Dimension (mm)	10.4±0.1	7.52±0.1	1.5±0.1	1.5+0.1/-0	1.75±0.1	7.5±0.1

Dimension No.	Po	P1	P2	t	W	K
Dimension (mm)	4.0±0.15	16.0±0.1	2.0±0.1	0.35±0.03	16.0±0.2	4.5±0.1



LIGHTING FOREVER

# 6 PIN DIP PHOTOTRANSISTOR PHOTOCOUPLER

## CNY17-X Series CNY17F-X Series

### Solder Reflow Temperature Profile

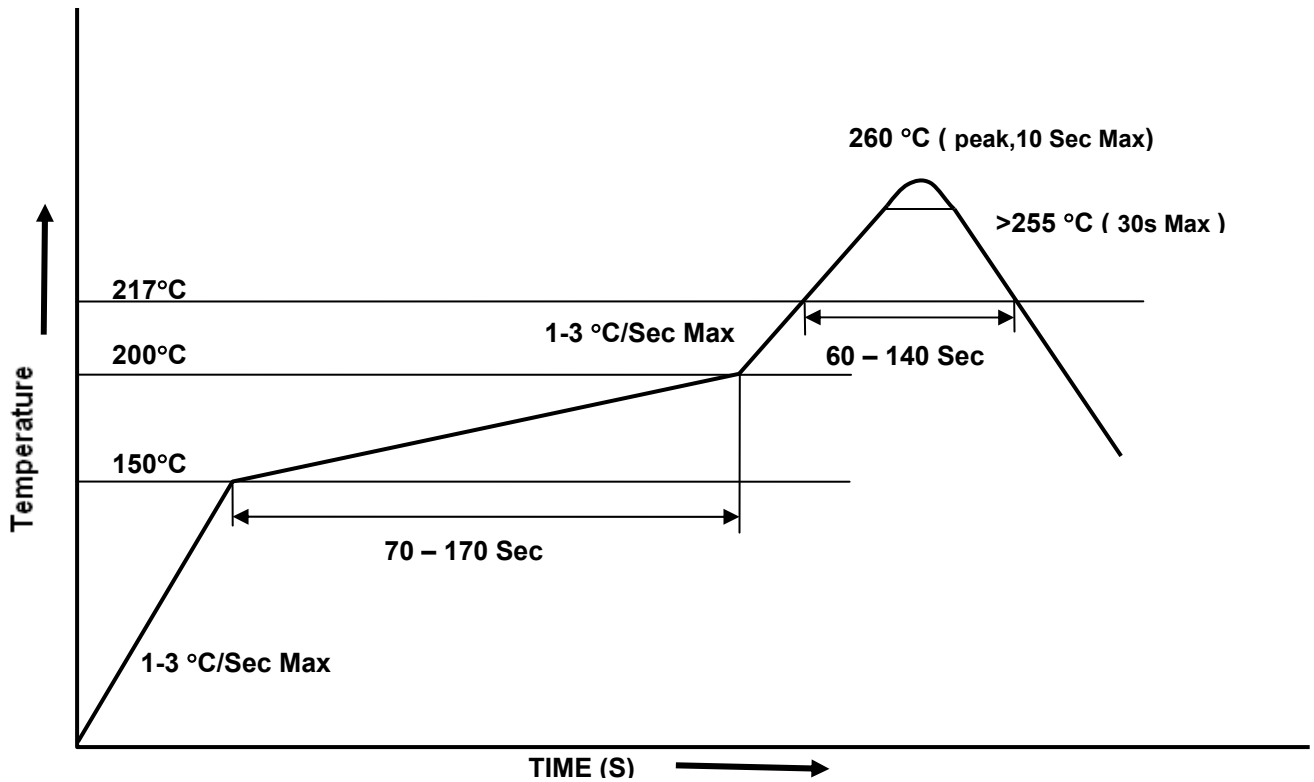



LIGHTING FOREVER

## 6 PIN DIP PHOTOTRANSISTOR PHOTOCOUPLER

**CNY17-X Series**  
**CNY17F-X Series**

---

### DISCLAIMER

1. Above specification may be changed without notice. EVERLIGHT will reserve authority on material change for above specification.
2. When using this product, please observe the absolute maximum ratings and the instructions for use outlined in these specification sheets. EVERLIGHT assumes no responsibility for any damage resulting from use of the product which does not comply with the absolute maximum ratings and the instructions included in these specification sheets.
3. These specification sheets include materials protected under copyright of EVERLIGHT. Reproduction in any form is prohibited without the specific consent of EVERLIGHT.

Компания «Life Electronics» занимается поставками электронных компонентов импортного и отечественного производства от производителей и со складов крупных дистрибьюторов Европы, Америки и Азии.

С конца 2013 года компания активно расширяет линейку поставок компонентов по направлению коаксиальный кабель, кварцевые генераторы и конденсаторы (керамические, пленочные, электролитические), за счёт заключения дистрибьюторских договоров

Мы предлагаем:

- Конкуренеспособные цены и скидки постоянным клиентам.
- Специальные условия для постоянных клиентов.
- Подбор аналогов.
- Поставку компонентов в любых объемах, удовлетворяющих вашим потребностям.
- Приемлемые сроки поставки, возможна ускоренная поставка.
- Доставку товара в любую точку России и стран СНГ.
- Комплексную поставку.
- Работу по проектам и поставку образцов.
- Формирование склада под заказчика.
- Сертификаты соответствия на поставляемую продукцию (по желанию клиента).
- Тестирование поставляемой продукции.
- Поставку компонентов, требующих военную и космическую приемку.
- Входной контроль качества.
- Наличие сертификата ISO.

В составе нашей компании организован Конструкторский отдел, призванный помогать разработчикам, и инженерам.

Конструкторский отдел помогает осуществить:

- Регистрацию проекта у производителя компонентов.
- Техническую поддержку проекта.
- Защиту от снятия компонента с производства.
- Оценку стоимости проекта по компонентам.
- Изготовление тестовой платы монтаж и пусконаладочные работы.



Тел: +7 (812) 336 43 04 (многоканальный)  
Email: [org@lifeelectronics.ru](mailto:org@lifeelectronics.ru)