



LIGHTING FOREVER

6 PIN DIP PHOTOTRANSISTOR PHOTOCOUPLER

CNY17-X Series CNY17F-X Series

Features

- Current transfer ratios in selected narrow range groups
CNY17-1, CNY17F-1: 40-80%
CNY17-2, CNY17F-2: 63-125%
CNY17-3, CNY17F-3: 100-200%
CNY17-4, CNY17F-4:160-320%
- High isolation voltage between input and output
(Viso = 5000 Vrms)
- Creepage distance > 7.6 mm
- Operating temperature up to +110°C
- The CNY17F-X series offers no external base connection for minimum noise susceptibility
- Compact dual-in-line package
- Pb free and RoHS compliant.
- UL approved (No. E214129)
- VDE approved (No. 132249)
- SEMKO approved
- NEMKO approved
- DEMKO approved
- FIMKO approved
- CSA approved



Schematic

Description

The CNY17-X and CNY17F-X series of devices each consist of an infrared emitting diode optically coupled to a phototransistor.

packaged in a 6-pin DIP package and available in wide-lead spacing and SMD option.

Applications

- Power supply regulators
- Digital logic inputs
- Microprocessor inputs

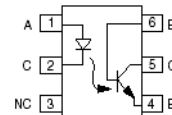

CNY17-X

1. Anode
2. Cathode
3. No Connection
4. Emitter
5. Collector
6. Base

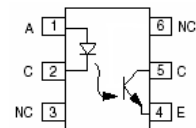

CNY17F-X

1. Anode
2. Cathode
3. No Connection
4. Emitter
5. Collector
6. No Connection



LIGHTING FOREVER

6 PIN DIP PHOTOTRANSISTOR PHOTOCOUPLER

CNY17-X Series CNY17F-X Series

Absolute Maximum Ratings ($T_a=25^{\circ}\text{C}$)

Parameter		Symbol	Rating	Unit
Input	Forward current	I_F	60	mA
	Peak forward current ($t = 10\mu\text{s}$)	I_{FM}	1	A
	Reverse voltage	V_R	6	V
	Power dissipation ($T_A = 25^{\circ}\text{C}$)	P_D	100	mW
	Derating factor (above 100°C)		3.8	mW/ $^{\circ}\text{C}$
Output	Collector-Emitter voltage	V_{CEO}	80	V
	Collector-Base voltage ^{*1}	V_{CBO}	80	V
	Collector current	I_C	50	mA
	Emitter-Collector voltage	V_{ECO}	7	V
	Power dissipation ($T_A = 25^{\circ}\text{C}$)	P_C	150	mW
Derating factor (above 100°C)	9.0		mW/ $^{\circ}\text{C}$	
Total power dissipation		P_{tot}	200	mW
Isolation voltage ^{*2}		V_{iso}	5000	Vrms
Operating temperature		T_{opr}	-55~+110	$^{\circ}\text{C}$
Storage temperature		T_{stg}	-55~+125	$^{\circ}\text{C}$
Soldering temperature ^{*3}		T_{sol}	260	$^{\circ}\text{C}$

Notes

*1 Only for CNY17-X series.

*2 AC for 1 minute, R.H.= 40 ~ 60% R.H. In this test, pins 1, 2 & 3 are shorted together, and pins 4, 5 & 6 are shorted together.

*3 For 10 seconds.



LIGHTING FOREVER

6 PIN DIP PHOTOTRANSISTOR PHOTOCOUPLER

CNY17-X Series CNY17F-X Series

Electrical Characteristics ($T_a=25^\circ\text{C}$ unless specified otherwise)

Input

Parameter	Symbol	Min.	Typ.*	Max.	Unit	Condition
Forward voltage	V_F	-	-	1.65	V	$I_F = 60\text{mA}$
Reverse current	I_R	-	-	10	μA	$V_R = 6\text{V}$
Input capacitance	C_{in}	-	18	-	pF	$V = 0, f = 1\text{MHz}$

Output

Parameter	Symbol	Min.	Typ.*	Max.	Unit	Condition
Collector-Base dark current	CNY17-X only I_{CBO}	-	-	20	nA	$V_{CB} = 10\text{V}, I_F = 0\text{mA}$
Collector-Emitter dark current	I_{CEO}	-	-	50	nA	$V_{CE} = 10\text{V}, I_F = 0\text{mA}$
Collector-Emitter breakdown voltage	BV_{CEO}	80	-	-	V	$I_C = 1\text{mA}, I_F = 0\text{mA}$
Collector-Base breakdown voltage	CNY17-X only BV_{CBO}	80	-	-	V	$I_C = 0.1\text{mA}, I_F = 0\text{mA}$
Emitter-Collector breakdown voltage	BV_{ECO}	7	-	-	V	$I_E = 0.1\text{mA}, I_F = 0\text{mA}$
Collector-Emitter capacitance	C_{CE}	-	8	-	pF	$V_{CE} = 0\text{V}, f = 1\text{MHz}$

* Typical values at $T_a = 25^\circ\text{C}$



LIGHTING FOREVER

6 PIN DIP PHOTOTRANSISTOR PHOTOCOUPLER

CNY17-X Series CNY17F-X Series

Transfer Characteristics ($T_a=25^\circ\text{C}$ unless specified otherwise)

Parameter		Symbol	Min.	Typ.*	Max.	Unit	Condition
Current Transfer Ratio	CNY17-1 CNY17F-1	CTR	40	-	80	%	$I_F = 10\text{mA}, V_{CE} = 5\text{V}$
	CNY17-2 CNY17F-2		63	-	125		
	CNY17-3 CNY17F-3		100	-	200		
	CNY17-4 CNY17F-4		160	-	320		
Current Transfer Ratio	CNY17-1 CNY17F-1	CTR	13	-	-	%	$I_F = 1\text{mA}, V_{CE} = 5\text{V}$
	CNY17-2 CNY17F-2		22	-	-		
	CNY17-3 CNY17F-3		34	-	-		
	CNY17-4 CNY17F-4		56	-	-		
Collector-Emitter saturation voltage		$V_{CE(sat)}$	-	-	0.3	V	$I_F = 10\text{mA}, I_C = 2.5\text{mA}$
Isolation resistance		R_{IO}	10^{11}	-	-	Ω	$V_{IO} = 500\text{Vdc}$
Input-output capacitance		C_{IO}	-	0.5	-	pF	$V_{IO} = 0, f = 1\text{MHz}$
Turn-on time		T_{on}	-	10	12	μs	$V_{CC} = 10\text{V}, I_C = 2\text{mA}, R_L = 100\Omega$ See Fig. 11
Turn-off time		T_{off}	-	9	12		
Rise time		T_r	-	6	10		
Fall time		T_f	-	8	10		
Rise time		T_r	-	2	10		$V_{CC} = 5\text{V}, I_F = 10\text{mA}, R_L = 75\Omega, \text{ See Fig. 11}$
Fall time		T_f	-	3	10		

* Typical values at $T_a = 25^\circ\text{C}$



LIGHTING FOREVER

6 PIN DIP PHOTOTRANSISTOR PHOTOCOUPLER

CNY17-X Series CNY17F-X Series

Typical Performance Curves

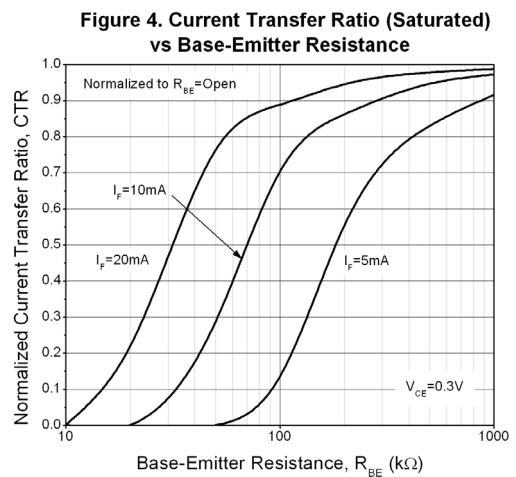
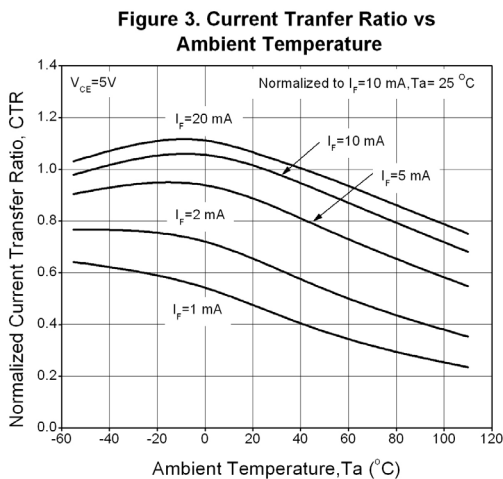
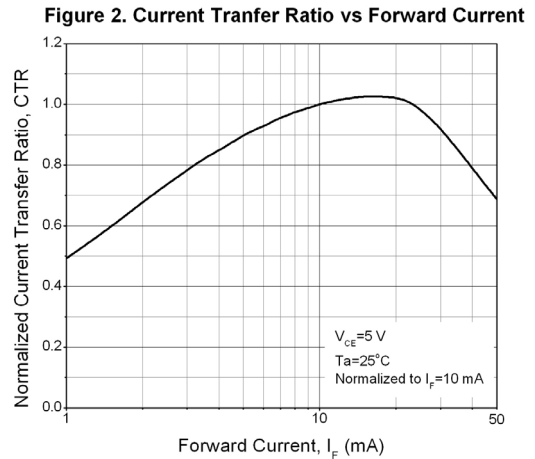
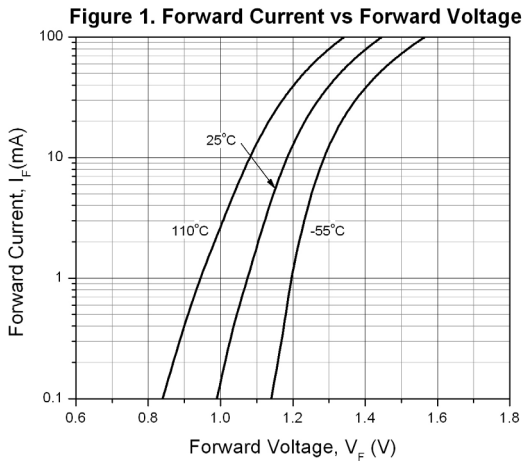

6 PIN DIP PHOTOTRANSISTOR PHOTOCOUPLER

CNY17-X Series CNY17F-X Series

Figure 7. Collector-Emitter Saturation Voltage vs Collector Current

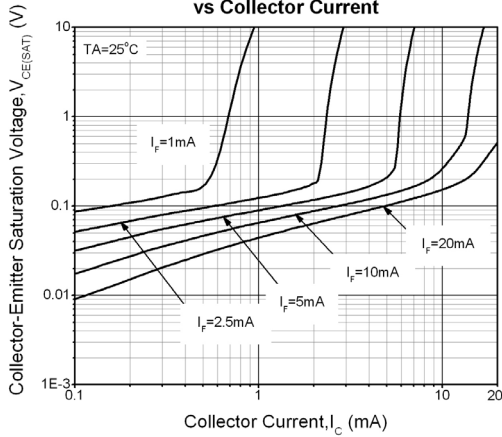

Figure 8. Switching Time vs Load Resistance

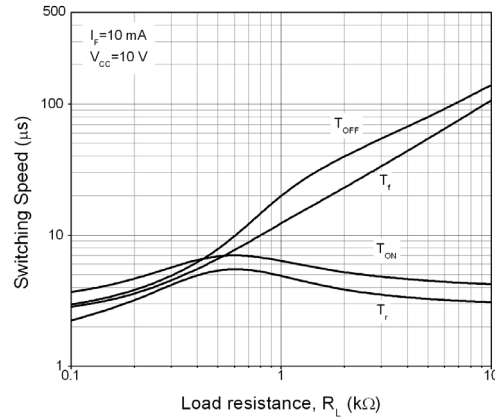

Figure 9. Turn-on Time vs Base-Emitter Resistance

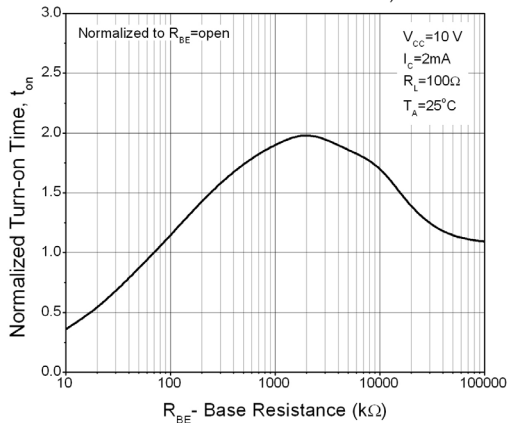

Figure 10. Turn-off Time vs Base-Emitter Resistance

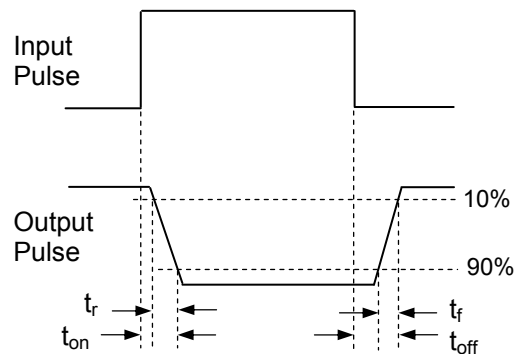
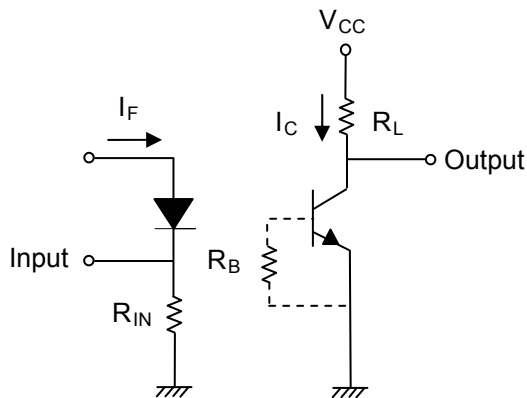

Figure 11. Switching Time Test Circuit & Waveforms



LIGHTING FOREVER

6 PIN DIP PHOTOTRANSISTOR PHOTOCOUPLER

CNY17-X Series
CNY17F-X Series

Order Information

Part Number

CNY17-XY(Z)-V

or

CNY17F-XY(Z)-V

Note

- X = Part no. (1, 2, 3 or 4)
- Y = Lead form option (S, S1, M or none)
- Z = Tape and reel option (TA, TB or none).
- V = VDE (optional)

Option	Description	Packing quantity
None	Standard DIP-6	65 units per tube
M	Wide lead bend (0.4 inch spacing)	65 units per tube
S (TA)	Surface mount lead form + TA tape & reel option	1000 units per reel
S (TB)	Surface mount lead form + TB tape & reel option	1000 units per reel
S1 (TA)	Surface mount lead form (low profile) + TA tape & reel option	1000 units per reel
S1 (TB)	Surface mount lead form (low profile) + TB tape & reel option	1000 units per reel



LIGHTING FOREVER

6 PIN DIP PHOTOTRANSISTOR PHOTOCOUPLER

CNY17-X Series CNY17F-X Series

Package Drawings

(Dimensions in mm)

Standard DIP Type



Option M Type





LIGHTING FOREVER

6 PIN DIP PHOTOTRANSISTOR PHOTOCOUPLER

CNY17-X Series CNY17F-X Series

Option S Type



Option S1 Type





LIGHTING FOREVER

6 PIN DIP PHOTOTRANSISTOR PHOTOCOUPLER

CNY17-X Series CNY17F-X Series

Recommended pad layout for surface mount leadform



Device Marking



Notes

- EL denotes Everlight
- CNY17-X denotes Device Number (X: 1, 2, 3 or 4)
- Y denotes 1 digit Year code
- WW denotes 2 digit Week code
- V denotes VDE (optional)



LIGHTING FOREVER

6 PIN DIP PHOTOTRANSISTOR PHOTOCOUPLER

CNY17-X Series CNY17F-X Series

Tape & Reel Packing Specifications

Option TA

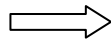
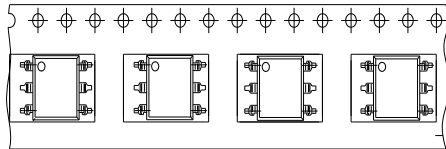

Direction of feed from reel

Option TB

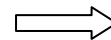
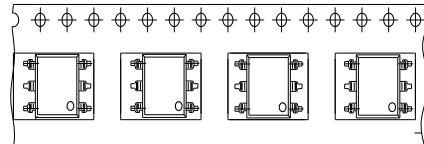

Direction of feed from reel

Tape dimensions

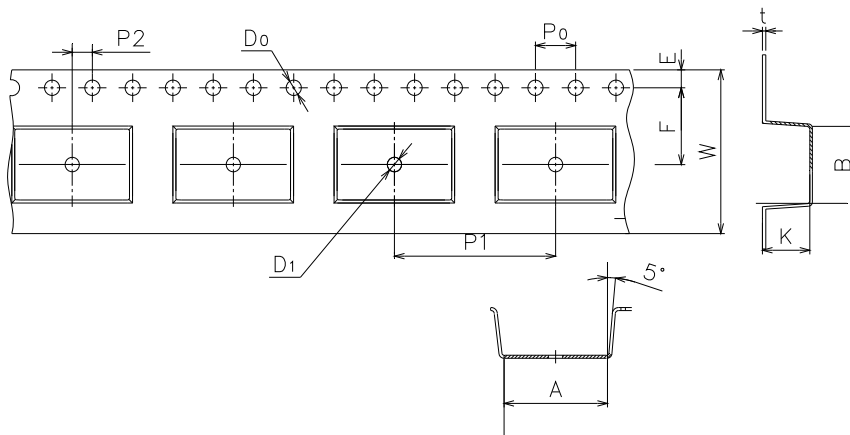

Dimension No.	A	B	Do	D1	E	F
Dimension (mm)	10.4±0.1	7.52±0.1	1.5±0.1	1.5+0.1/-0	1.75±0.1	7.5±0.1

Dimension No.	Po	P1	P2	t	W	K
Dimension (mm)	4.0±0.15	16.0±0.1	2.0±0.1	0.35±0.03	16.0±0.2	4.5±0.1



LIGHTING FOREVER

6 PIN DIP PHOTOTRANSISTOR PHOTOCOUPLER

CNY17-X Series CNY17F-X Series

Solder Reflow Temperature Profile

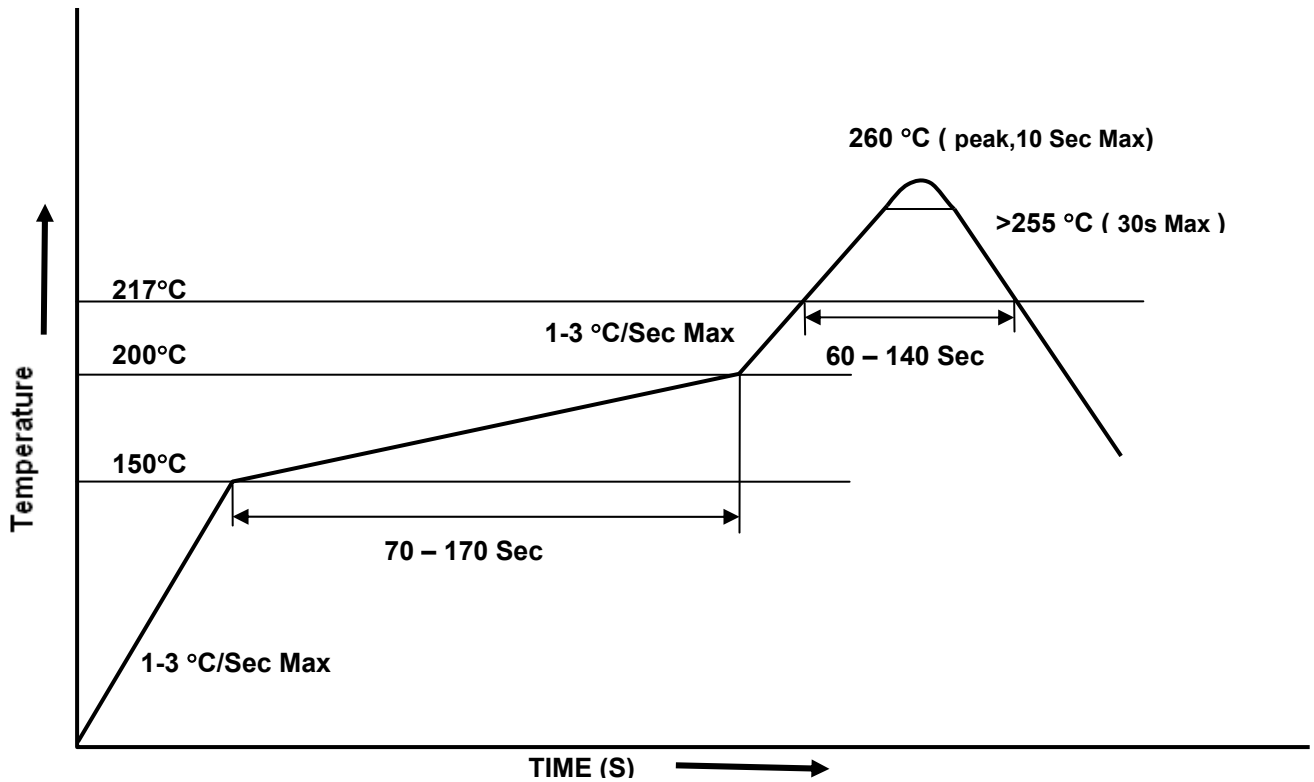



LIGHTING FOREVER

6 PIN DIP PHOTOTRANSISTOR PHOTOCOUPLER

CNY17-X Series
CNY17F-X Series

DISCLAIMER

1. Above specification may be changed without notice. EVERLIGHT will reserve authority on material change for above specification.
2. When using this product, please observe the absolute maximum ratings and the instructions for use outlined in these specification sheets. EVERLIGHT assumes no responsibility for any damage resulting from use of the product which does not comply with the absolute maximum ratings and the instructions included in these specification sheets.
3. These specification sheets include materials protected under copyright of EVERLIGHT. Reproduction in any form is prohibited without the specific consent of EVERLIGHT.

Компания «Life Electronics» занимается поставками электронных компонентов импортного и отечественного производства от производителей и со складов крупных дистрибьюторов Европы, Америки и Азии.

С конца 2013 года компания активно расширяет линейку поставок компонентов по направлению коаксиальный кабель, кварцевые генераторы и конденсаторы (керамические, пленочные, электролитические), за счёт заключения дистрибьюторских договоров

Мы предлагаем:

- Конкурентоспособные цены и скидки постоянным клиентам.
- Специальные условия для постоянных клиентов.
- Подбор аналогов.
- Поставку компонентов в любых объемах, удовлетворяющих вашим потребностям.
- Приемлемые сроки поставки, возможна ускоренная поставка.
- Доставку товара в любую точку России и стран СНГ.
- Комплексную поставку.
- Работу по проектам и поставку образцов.
- Формирование склада под заказчика.
- Сертификаты соответствия на поставляемую продукцию (по желанию клиента).
- Тестирование поставляемой продукции.
- Поставку компонентов, требующих военную и космическую приемку.
- Входной контроль качества.
- Наличие сертификата ISO.

В составе нашей компании организован Конструкторский отдел, призванный помогать разработчикам, и инженерам.

Конструкторский отдел помогает осуществить:

- Регистрацию проекта у производителя компонентов.
- Техническую поддержку проекта.
- Защиту от снятия компонента с производства.
- Оценку стоимости проекта по компонентам.
- Изготовление тестовой платы монтаж и пусконаладочные работы.



Тел: +7 (812) 336 43 04 (многоканальный)

Email: org@lifeelectronics.ru