

Table of Contents

Contents

High-Speed Contacts Overview	2	Quadrax Rectangular Connectors (General Description)	41
How to Choose, Cable Usage Guide, Testing	3	High Speed Contacts for Rack & Panel (ARINC 600 & R27)	42
OCS (Oval Contact System) Connectors	4	Insert Arrangements-MIL-DTL-38999 (Incorporating Coax, Twinax and Triax Contacts)	43-45
OCS - Contact Eye Pattern at 10 Gbps	5	Coaxial Contacts (General Description)	46
OCS - How to Order	6	Coaxial Contacts (Contact Part Number Guide by Cable)	47-50
OCS - Insert Arrangements - Front face of pins illustrated	7	Matched Impedance Coaxial Contacts - MIL-DTL-38999	51-52
OCS - TVP00 - Crimp, Metal & CTVP00 -Wall Mounting	8	High Frequency Coax Contacts (Series III Circular General Description)	53
OCS - TV06 - Crimp, Metal & CTV06R - Straight Plug	9	High Frequency Coax Contacts	54
OCS - TV07R - Crimp, Metal & CTV07R - Jam Nut Rec	10	Concentric Twinax Contacts (General Description, Application Data - Size 8)	55
Insert Arrangements-Series III Incorporating Octonet, Quadrax & Differential Twinax Contacts	11-12	Concentric Twinax Contacts (Contact Part Number Guide by Cable)	56-59
Octonet Contacts	13-14	Triax Contacts (Contact Part Number Guide by Cable)	60
Signal Integrity Contact Data, Insertion and Return Loss	15-16	Coax, Twinax & Triax PC Tail Contacts (General Description, Application Data)	61
CTF-Quad (Copper to Fiber) Media Converter	17	Coax, Twinax & Triax PC Tail Contacts (Contact Part Number Guide)	62-63
CTF-QUAD, How to Order	18	MRC Connectors (High Speed Micro-Miniature Series)	64
Quadrax Contacts, Series III, General Description	19	MRC - 9 Pin Mount Plug (How to Order)	65
How to Order D38999, Series III Connectors with 100 Ohm	20	Ethernet Cable Assemblies (How to Order)	66
Quadrax Contacts	21-22	9 Pin Pig Tail Cable Assemblies (How to Order)	67
Quadrax Contacts (Series III, Guide by Cable)	21-22	USB 2.0 / 3.0 Cable Assemblies (How to Order)	68
Quadrax Contacts (Series III, Contact Guide for PCB)	23-24	19 Pin HDMI Chassis Mount Plug (How to Order)	69
Quadrax Transition Adapters (General Description)	25	HDMI Cable Assemblies (How to Order)	70
Quadrax Transition Adapters (Series III, Part Number Guide)	26-28	19 Pin Pig Tail Cable Assemblies (How to Order)	71
Split-Pair Quadrax Contacts & Cables (Features & Benefits/ How to Order)	29	MRC - Protection Cap for Plug	72
Split-Pair Quadrax Contacts (PCB Contacts & Transition Adapter Contacts)	30	Connector Options	73
Split-Pair Quadrax Contacts (Frequencies & Performance Data)	31-32	High-Speed/High Frequency Contact Design Form	74
Differential Twinax Contacts (General Description)	33		
Differential Twinax Contacts (Series III, Contact Part Number Guide by Cable)	34-35		
Differential Twinax Transition Adapters (Series III, Attachment to PC Boards Data)	36-37		
Micro Differential Twinax Transition Adapters (Push-Pull Interconnects)	38-40		

High-Speed Contacts Typical Markets:



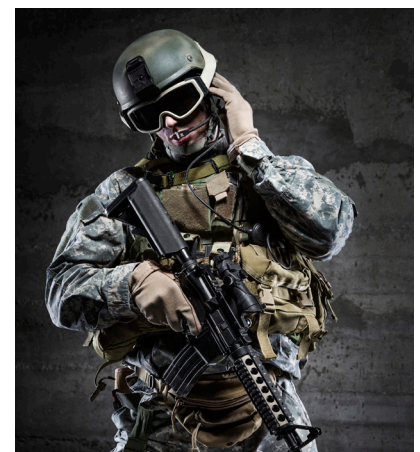







Military & Commercial Aviation, Military Vehicles, Missiles & Ordnance, C4ISR



High-Speed Contacts

Overview

Amphenol has the broadest and most reliable contact solutions when you need superior electrical performance, plus shielding to eliminate interference from outside electrical sources, in a connector. Our expertise in connector and cable solutions ensures that your contacts will mate and perform to the proper application specifications.

Contact Options	Product	Page	Description
	Oval Contact System	4-10	Our newest contact for high-speed data transmission up to 10 Gbps per pair. Applications include: 10G Base T, 40G Base T, HDMI, Fibre Channel (AI), SATA 2.0, 3.0, and others.
	Octonet Contacts	13-15	Size 8 pin and socket contacts. 8 strategically-spaced inner contacts form 4 100 Ohm matched impedance differential pairs.
	CTF-Quad	17-18	The CTF-QUAD product line is fiber to copper and copper to fiber media conversion in quadrax form factor pins for standard D38999 quadrax insert arrangements.
	Quadrax Contacts	19-32	Size 8 pin and socket contacts. An outer contact with 4 strategically spaced inner contacts forming two 100 or 150 Ohm matched impedance differential pairs.
	Transition Adapters	25-28, 30 36-40	Matched impedance quadrax and twinax transition adapters provide a method of launching from the high speed connectors to PCB boards.
	Differential Twinax Contacts	33-40	Size 8 pin and socket contacts. An outer contact with 2 inner contacts spaced to form one 100 or 150 Ohm matched impedance differential pair.
	Coaxial Contacts	46-52	Sizes 4, 8, 12 & 16 pin and socket contacts designed for RF/microwave and shielded wire applications.
	High Frequency	53-54	Size 8 Coaxial contacts that provide high frequencies (DC to 65 GHz). Unique "Float Mount" technology maintains tight mechanical tolerances.
	Concentric Twinax Contacts	55-58	Sizes 8 & 12 pin and socket contacts designed for protection from magnetic and electro-static interference including nuclear electromagnetic pulse.
	Triax Contacts	59-60	Sizes 8, 10 & 12 pin and socket contacts designed for shielded wire applications with 3 conductors.
	MRC	64-72	MRC is a micro-miniature connector ideal for Commercial, Industrial and Military Communication Systems. This series is capable of running Gigabit Ethernet, USB 2.0/USB 3.0, HDMI and 10 Gigabit Ethernet when specified and designated to a specific configuration.

GENERAL ORDERING INFORMATION

This catalog is primarily for high-speed contact solutions used in MIL-DTL-38999 Series, I, II, and III connectors. Other connectors that incorporate high-speed contacts include:

- MIL-DTL-22992 Heavy Duty Circular Connectors: Coax contacts
- Low-Mating Force Rectangular Connectors: Coax contacts in hybrid arrangements
- LRM Interconnects – Rectangular module and backplane connectors: Coax contacts in hybrid arrangements
- ARINC 600 and R27 Rack & Panel Connectors: Quadrax, Twinax, Differential Twinax, and Coax contacts
- MIL-DTL-26482 Series 1 Connectors: Coax contacts
- MIL-DTL-5015 Connectors: Coax contacts

How to Choose, Cable Usage Guide, Capabilities & Testing

HOW TO CHOOSE HIGH-SPEED PRODUCTS

3-Step process to select the right solution for your design needs

1.

FIND YOUR CABLE AND CORRESPONDING HIGH-SPEED CONTACT

Locate your cable using our Cable Guide in each high-speed contact section. Match the cable to the proper specifications needed, such as contact size and impedance, then choose the correct contact part number.

2.

CHOOSE THE DESIRED INSERT PATTERN

D38999 Series III Insert arrangements for Quadrax and Differential Twinax contacts are shown on pgs. 11-12. D38999 Series I, II, and III insert arrangements for Coax, Twinax, and Triax contacts are shown on pgs. 42-44.

3.

CONTACT AMPHENOL FOR THE CONNECTOR OR CABLE PART NUMBER

Once the contact and the insert arrangement have been selected, contact Amphenol Aerospace to get the proper connector or cable assembly part number.

CABLE USAGE GUIDE

In general, for D38999 Connectors, the size 8, 12 and 16 Coax, Quadrax, Twinax and Triax will terminate cable in the following ranges.

SIZE 8

.012 / .0395 Center Conductor (Stranded)
.055 / .133 Dielectric
.180 Max Outer braid (must be round for crimp termination)
.201 Max. Jacket

SIZE 16

.012 / .0215 Center Conductor (Stranded)
.031 / .066 Dielectric
.085 Max Outer braid (must be round for crimp termination)
.102 Max. Jacket

SIZE 12

.012 / .0215 Center Conductor (Stranded)
.031 / .105 Dielectric
.126 Max Outer braid (must be round for crimp termination)
.145 Max. Jacket

Special coax contacts may be available for cables outside of ranges shown. Consult Amphenol Aerospace for further assistance in selection of coax contact cables.



CABLE CAPABILITIES

Amphenol provides a large array of cable assemblies with high-speed quadrax and differential twinax contacts, as well as coax and concentric twinax contacts. Amphenol offers customers the most up-to-date range of cable assemblies in the market. Amphenol can design and supply your cable needs for high speed contacts and connector, from a simple point-to-point cable to a multi-branch cable system. Contact Amphenol Aerospace for assistance in designing the best cable assembly to fit your design needs.

CABLE TESTING

Rigid testing is performed on 100% of the cable assemblies at Amphenol before they're shipped, to make sure they meet customer requirements, including DWV, insulation resistance, and continuity. Amphenol has the background experience and understanding of harsh environmental testing to assure reliable "end-to-end" interconnect solutions.

TESTING CAPABILITIES

Single-Ended (50 ohm) measurements to 20 GHz include:

- Insertion loss
- Return loss
- VSWR
- Electrical length
- Phase-matching capability
- Impedance
- Touchstone files

Differential measurement to 20 GHz include:

- Insertion loss
- Return loss
- Intra-pair skew
- Inter-pair skew
- Differential impedance
- Common mode conversion
- Touchstone files

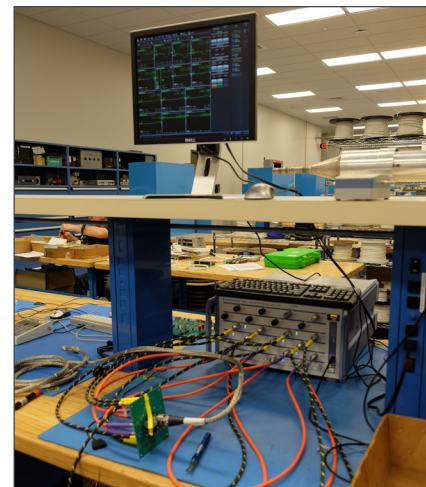

OCS (Oval Contact System) Connectors

OVERVIEW

The OCS (Oval Contact System) is the newest 38999 Interconnect Product offering that provides many advantages for high speed data transmission.

OCS MECHANICAL/PHYSICAL PROPERTIES

- Mating Cycles 500 (min.)
- Operating temperature -65C to 175C
- Contact materials and platings consistent w/AS39029
- IR 500 VDC
- DWV 500 VAC rms

Max Current Rating:

- 1.5 amps inner contacts
- 3.0 amps outer contacts

OCS SIGNAL INTEGRITY PERFORMANCE

- Data rate:** 10Gbps per pair
Insertion loss: <0.3 dB up to 5 GHz
Return loss: >20 dB up to 5 GHz
NEXT and FEXT: >40 dB up to 5 GHz
Differential to common mode conversion: >50 dB up to 5 GHz



Plug



Receptacle



Four of Amphenol's OCS Contacts fit into the 38999 Connector shell size 13

FEATURES AND BENEFITS

- A wide variety of insert arrangements available
- Patterns range from (1) to (21), 100 Ohm differential pairs capable of delivering data transfer speeds of 10Gbps per pair
- MIL-DTL-38999 shell styles available from size 9 to 25
- Front-release, rear-removable contact system for easy repair
- Meets environmental requirements of MIL-DTL-38999
- Uses off-the-shelf Mil Spec backshells
- PCB Tails contacts available, sockets only, epoxy backfilled.

APPLICATIONS

High Speed Applications-for use with, but not limited to, the following electrical protocols*:

- 10G Base T
- HDMI
- Fibre Channel (AI)
- 40G Base-T
- SATA 2.0
- SATA 3.0 (limited to 3 meters max)
- Serial RapidIO
- PCI Express 3.0

* Cable selection may limit data rate of protocols.



OCS (Oval Contact System) Connectors

Contact Eye Pattern at 10 Gbps

EYE DIAGRAM (REAL PART)

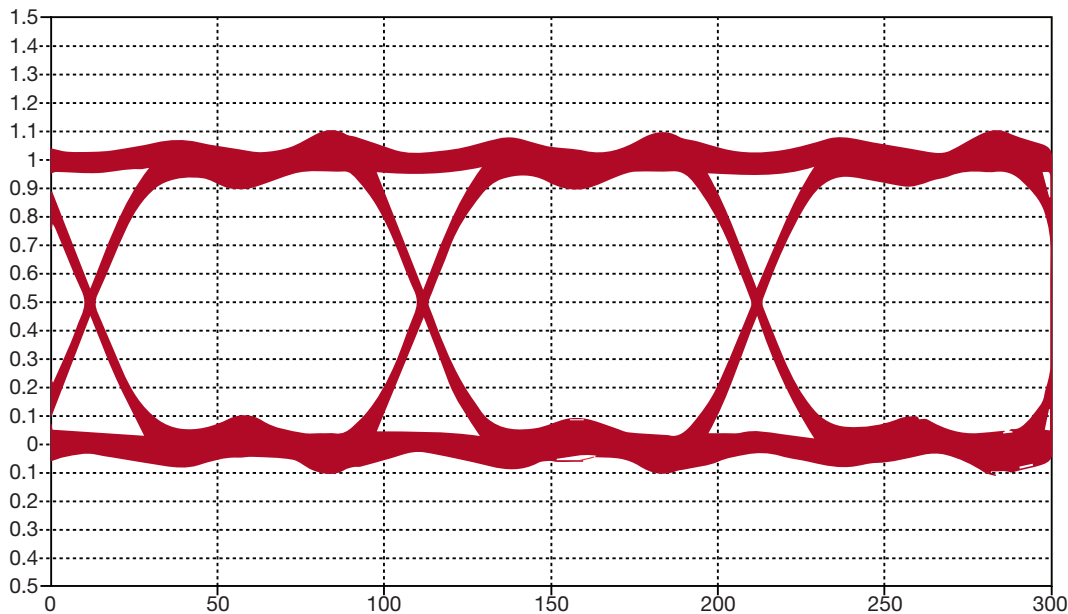

Individually Shielded Twinax cable is recommended for use with the OCS connectors. Other type of wires can be used, but will not be compatible with the rear accessory supplied with the connectors. Below is a list of recommended cables. Additional cables can be used if they meet specifications.

The provided grommet assembly will accommodate cable diameters ranging from Ø.124 to Ø.175. Larger diameters may work based on cable construction.

Impedance (Ohms)	Conductor (AWG)	Pairs	Cable Part Number
100	24	1	Tensolite 24463/9P025X-2(LD)
			Thermax MX100-24
			PIC E10224
			Gore GSC-05-82559-00 (space rated)
			Gore DXN2602
	24	4	Gore RCN 9034-24 (CAT6A Ethernet)*
	26	4	Gore RCN 9034-26 (CAT6A Ethernet)*
1		Spectra Strip 160-2699-952	

*Optimized for 13-53 insert pattern.

OCS cable assemblies available, please consult Amphenol Aerospace for details.

OCS (Oval Contact System) Connectors

How to Order

1.	2.	3.	4.	5.	6.
Connector Type and Shell Style	Service Class	Shell Size – Insert Arrangement	Contact Type	Alternate Keying Position	Suffix Code
TVP00	RZW	13-53	P	B	(595)

1. CONNECTOR TYPE	
TVP00	Wall Mount Back panel mounted receptacle with metal shells
CTVP00	Wall Mount Back panel mounted receptacle with composite shells
TV06	Straight Plug
CTV06	Straight Plug composite shells
TV07	Jam Nut
CTV07	Jam Nut composite shells

2. SERVICE CLASS		
(Z) Threaded Backshell Style	(W) Integral Backshell Style*	Description
RZF	RWF	Electroless nickel plated
RGZF	RGWF	Electroless nickel plated ground plane
RZW	RWW	Olive drab cadmium plate
RGZW	RGWW	Olive drab cadmium plated ground plane
RZB	RWB	NiAlBronze
RGZB	RGWB	NiAlBronze ground plane
RZK	RWK	Corrosion resistance stainless steel
RGZK	RGWK	Stainless steel ground plane
ZDT	WDT	Durmalon plated, Nickel-PTFE alternative to cadmium
GZDT	GWDT	Groundplane Durmalon
ZDZ	WDZ	Black Zinc

* Integral Backshell - an integral backshell style eliminates the need for costly backshell accessories, and allows the user to attach the shield of their cable directly to the backshell. The integral shell style also provides superior EMI shielding and ease for overmold applications.



For unused OCS connector cavities:

- Leave the contact insert cavity empty in the connector.
- Size 12 MS27488-12-2 (orange color) sealing plug can be installed into the grommet of the backshell large end first.



RECEPTACLE (front face shown)

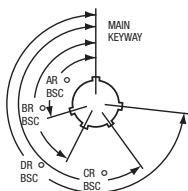

PLUG (front face shown)

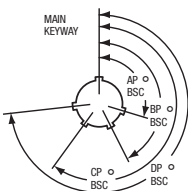

3. Select a Shell Size and Insert Arrangement

Shell Size and Insert Arrangement are together. First number represents Shell Size, second number is the Insert Arrangement. See page 7 for Insert Arrangements.

4. CONTACT TYPE	
P	Pin contacts 21-033585-001
S	Socket contacts 21-033586-001

Inner contacts accept 28, 26, and 24 awg cable.

5. Select an Alternate Keying Position

Alternate Positions below "N" not required for normal position

Tri-Start Alternate Positions:

A plug with a given rotation letter will mate with a receptacle with the same rotation letter.

SHELL SIZE	KEY & KEYWAY ARRANGEMENT IDENTIFICATION LETTER	AR° OR AP° BSC	BR° OR BP° BSC	CR° OR CP° BSC	DR° OR DP° BSC
9	N*	105	140	215	265
	A	102	132	248	320
	B	80	118	230	312
	C	35	140	205	275
	D	64	155	234	304
11, 13, and 15	N*	91	131	197	240
	A	95	141	208	236
	B	113	156	182	292
	C	90	145	195	252
	D	53	156	220	255
17 and 19	D	119	146	176	298
	E	51	141	184	242
	N*	80	142	196	293
	A	135	170	200	310
	B	49	169	200	244
21, 23, and 25	C	66	140	200	257
	D	62	145	180	280
	E	79	153	197	272
	N*	80	142	196	293
	A	135	170	200	310
	B	49	169	200	244
	C	66	140	200	257
	D	62	145	180	280
	E	79	153	197	272

6. SUFFIX CODE	
595	Space Grade
591	Space Grade with critical dimensions verified at 100%

Order information for Removal Tool OCS Contact
10-6460C1-001

OCS (Oval Contact System) Connectors

Insert Arrangements - Front face of pins illustrated

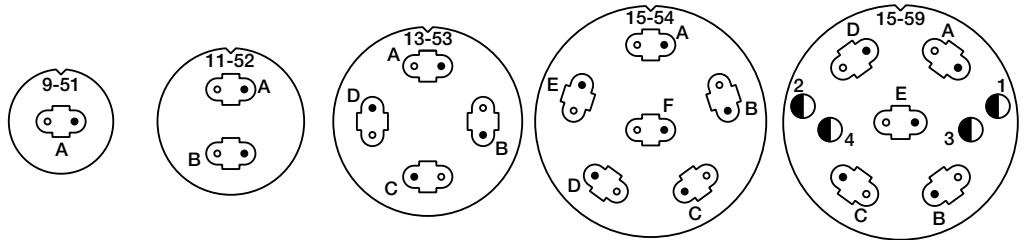

Insert Arrangement	9-51	11-52	13-53*	15-54	15-59*
Number of Contacts	1	2	4	6	5 OCS, 4 22D

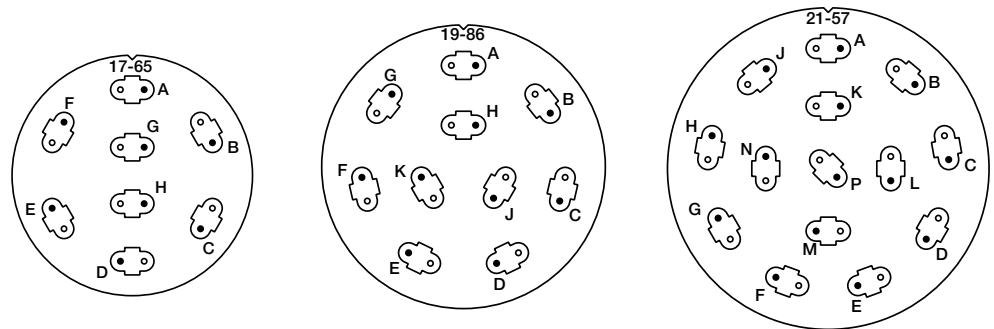

Insert Arrangement	17-65	19-86*	21-57*
Number of Contacts	8	10	14

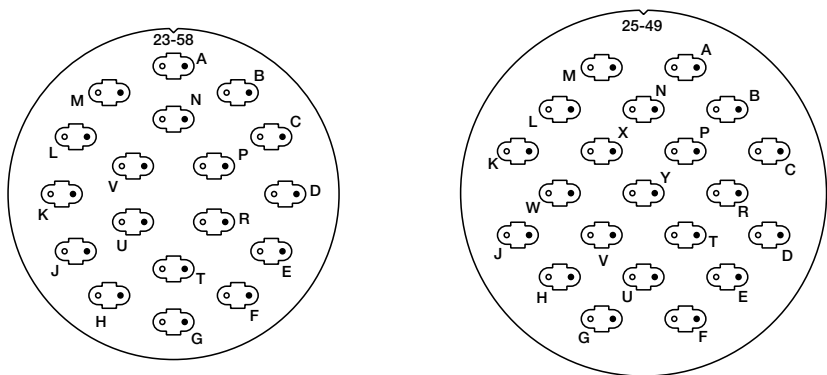

Insert Arrangement	23-58*	25-49*
Number of Contacts	18	21

* Indicates Insert currently tooled

• Designates pin 1 location within the OCS contact assembly

OCS (Oval Contact System) Connectors

TVP00 - Crimp, Metal & CTVP00 - Crimp, Composite Wall Mounting

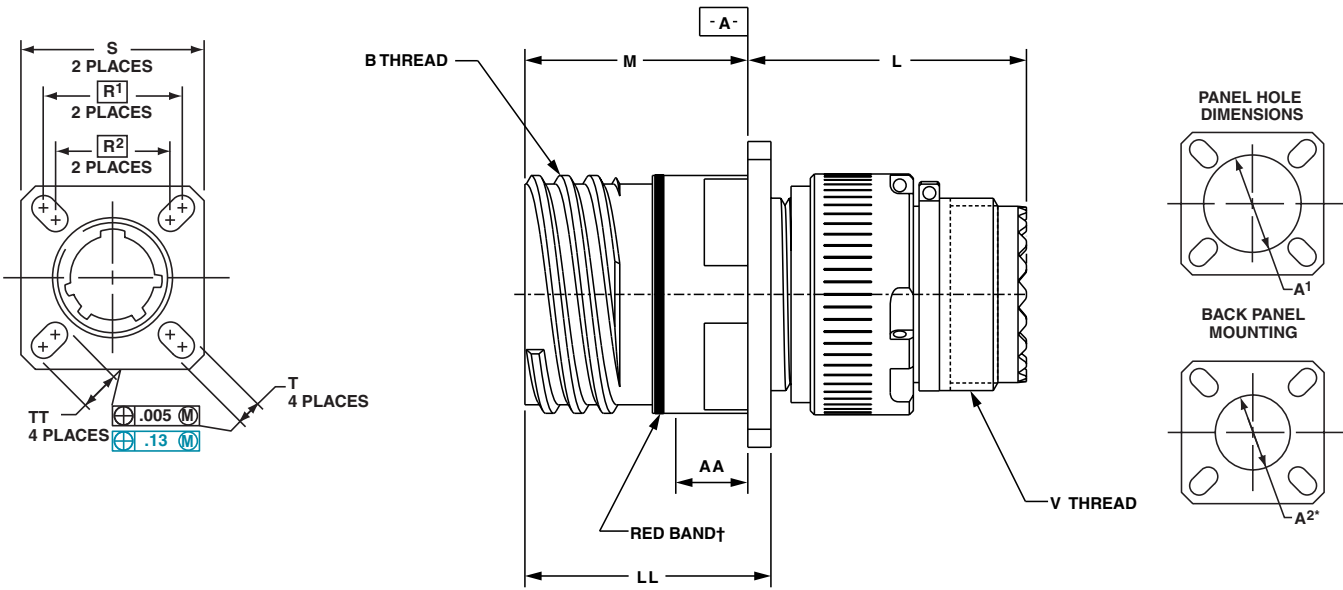

Shell Size	B Thread Class 2A 0.1P-0.3L-TS (Plated)	L Max. (TV)	L' Max. (CTV)	M +.000 - .005 (TV)	M' +.000 - .005 (CTV)	R ¹	R ²	S Max.	T ±.008	A ¹ Back Panel Mount	A ² Front Panel Mount	AA Max. Panel Thickness	LL +.006 - .000 (TV)	LL ±.005 (CTV)	TT ±.008	V Thread Metric
9	.6250	1.039	1.086	.820	.773	.719	.594	.948	.128	.655	.845	.234	.905	.908	.216	M12X1-6g
11	.7500	1.039	1.086	.820	.773	.812	.719	1.043	.128	.796	.963	.234	.905	.908	.194	M15X1-6g
13	.8750	1.039	1.086	.820	.773	.906	.812	1.137	.128	.922	1.081	.234	.905	.908	.194	M18X1-6g
15	1.0000	1.039	1.086	.820	.773	.969	.906	1.232	.128	1.047	1.239	.234	.905	.908	.173	M22X1-6g
17	1.1875	1.039	1.086	.820	.773	1.062	.969	1.323	.128	1.219	1.357	.234	.905	.908	.194	M25X1-6g
19	1.2500	1.039	1.086	.820	.773	1.156	1.062	1.449	.128	1.297	1.475	.234	.905	.908	.194	M28X1-6g
21	1.3750	1.069	1.118	.790	.741	1.250	1.156	1.575	.128	1.442	1.593	.204	.905	.904	.194	M31X1-6g
23	1.5000	1.069	1.118	.790	.741	1.375	1.250	1.701	.154	1.547	1.711	.204	.905	.904	.242	M34X1-6g
25	1.6250	1.069	1.118	.790	.741	1.500	1.375	1.823	.154	1.672	1.829	.204	.905	.904	.242	M37X1-6g

† Red band indicates fully mated

* A2 dimensions are larger than standard D38999 dimensions to accommodate backshell. All dimensions for reference only.

The rear accessory shown above is provided kitted with each connector and is for environmental sealing. The grommet included is insert arrangement specific, shown at right is the 13-53 pattern.

The provided grommet assembly will accommodate cable diameters ranging from Ø.124 to Ø.175. Larger diameters may work based on cable construction.

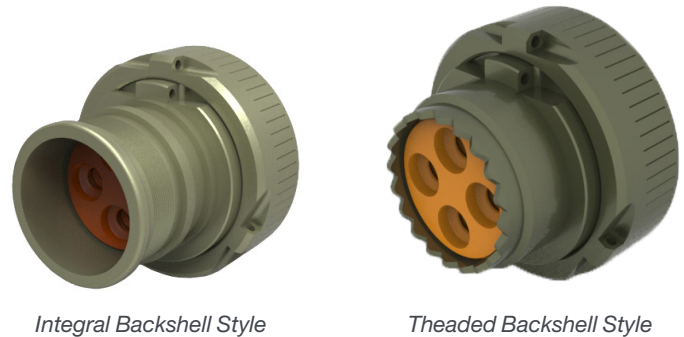

OCS (Oval Contact System) Connectors

TV06 - Crimp, Metal & CTV06R - Crimp, Composite Straight Plug

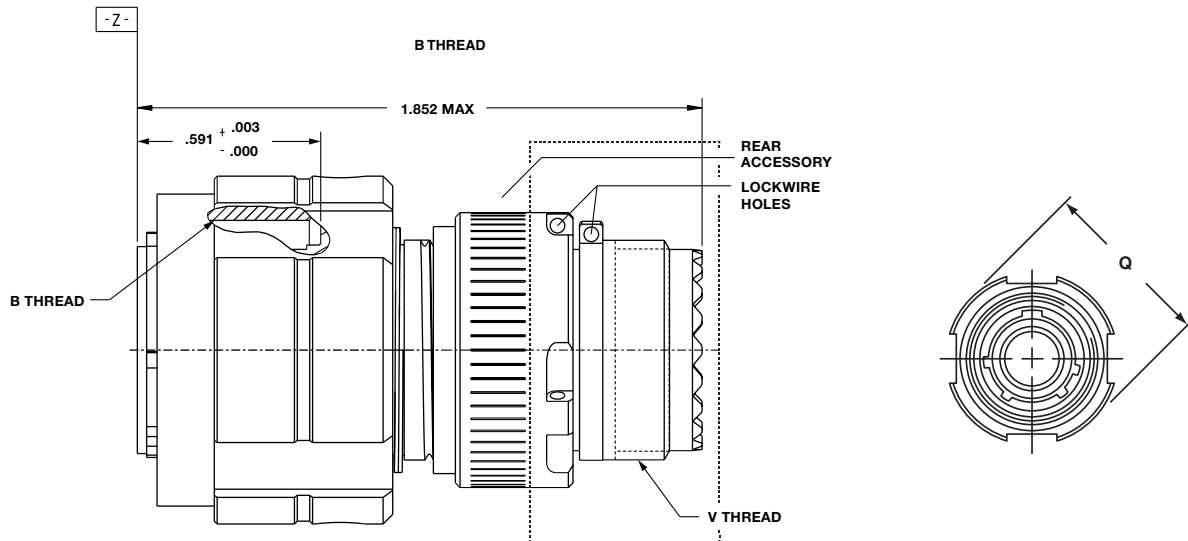

Shell Size	B Thread 0.1P-0.3L-TS-2B (Plated)	Q Dia. Max.	V Thread Metric
9	.6250	.858	M12X1-6g
11	.7500	.984	M15X1-6g
13	.8750	1.157	M18X1-6g
15	1.0000	1.280	M22X1-6g
17	1.1875	1.406	M25X1-6g
19	1.2500	1.516	M28X1-6g
21	1.3750	1.642	M31X1-6g
23	1.5000	1.768	M34X1-6g
25	1.6250	1.890	M37X1-6g

All dimensions for reference only.

The rear accessory shown above is provided kitted with each connector and is for environmental sealing. The grommet included is insert arrangement specific, shown at right is the 13-53 pattern.

The provided grommet assembly will accommodate cable diameters ranging from Ø.124 to Ø.175. Larger diameters may work based on cable construction.

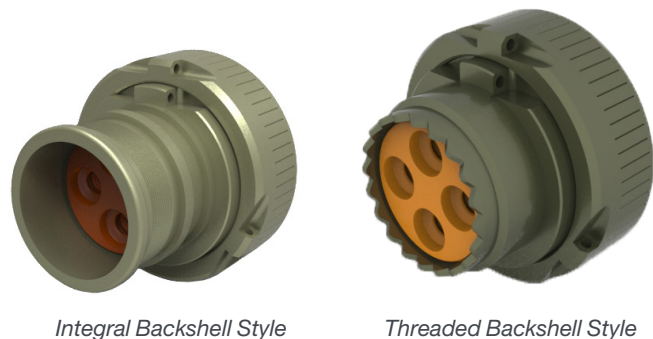

OCS (Oval Contact System) Connectors

TV07R - Crimp, Metal & CTV07R - Crimp, Composite Jam Nut Receptacle

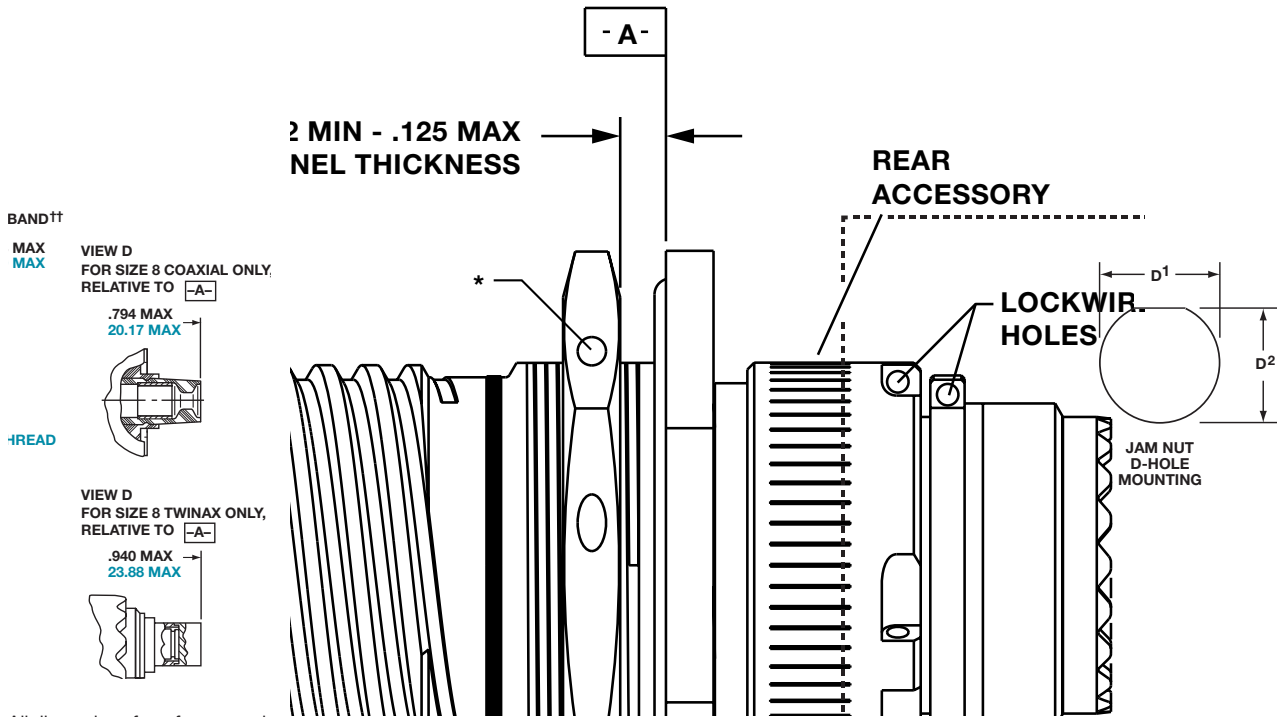

All dimensions for reference only.

Shell Size	B Thread Class 2A 0.1P-0.3L-TS (Plated)	C Max.	D ¹ +.010 - .000	D ² +.000 - .010	H Hex +.017 - .016	K Ref.	S ±.010	V Thread Metric
9	.6250	1.199	.693	.657	.875	.871	1.062	M12X1-6g
11	.7500	1.386	.825	.770	1.000	.871	1.250	M15X1-6g
13	.8750	1.511	1.010	.955	1.188	.878	1.375	M18X1-6g
15	1.0000	1.636	1.135	1.085	1.312	.878	1.500	M22X1-6g
17	1.1875	1.761	1.260	1.210	1.438	.878	1.625	M25X1-6g
19	1.2500	1.949	1.385	1.335	1.562	.878	1.812	M28X1-6g
21	1.3750	2.073	1.510	1.460	1.688	.878	1.938	M31X1-6g
23	1.5000	2.199	1.635	1.585	1.812	.878	2.062	M34X1-6g
25	1.6250	2.323	1.760	1.710	2.000	.878	2.188	M37X1-6g

† Red band indicates fully mated

* .059 dia min., 3 lockwire holes, Formed lockwire hole design (6 holes) is optional

The rear accessory shown above is provided kitted with each connector and is for environmental sealing. The grommet included is insert arrangement specific, shown at right is the 13-53 pattern.

The provided grommet assembly will accommodate cable diameters ranging from Ø.124 to Ø.175. Larger diameters may work based on cable construction.



Integral Backshell Style



Threaded Backshell Style

Insert Arrangements-MIL-DTL-38999, Series III

Incorporating Octonet, Quadrax & Differential Twinax Contacts

This illustrated listing represents the most readily available patterns incorporating Octonet, Quadrax and Differential Twinax contacts within D38999, Series III connectors. If you require other arrangements than what are shown here, consult Amphenol for further availability. In most cases, unless otherwise stated, size 8 cavities can be filled with Quadrax or Differential Twinax contacts. Arrangements can be mixed with any size 8 coax, and/or Concentric Twinax or Triax contacts.

Front face of pin inserts illustrated

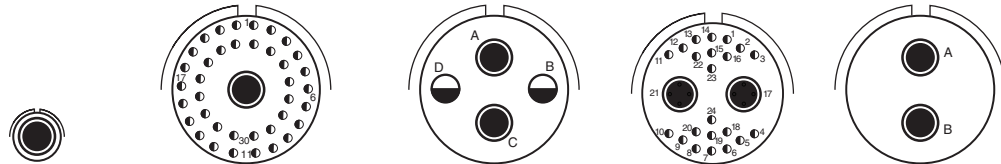

Insert Arrangement	9-5		17-2		17-22		17-25		17-52	
Number of Contacts	1		38		2		2		2	
Contact Size	8		22D		8		12		8	

Grounded

Meets Boeing Specification

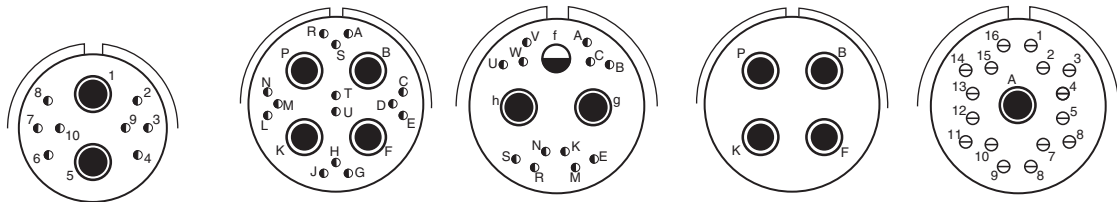

Insert Arrangement	17-60		19-18		19-31			19-AB		19-AD		
Number of Contacts	8		2		14		4		12		1	
Contact Size	22D		8		22D		12		8		8	

Note: 19-AB same as 19-18 but no 22D contacts.
Ground plane only.

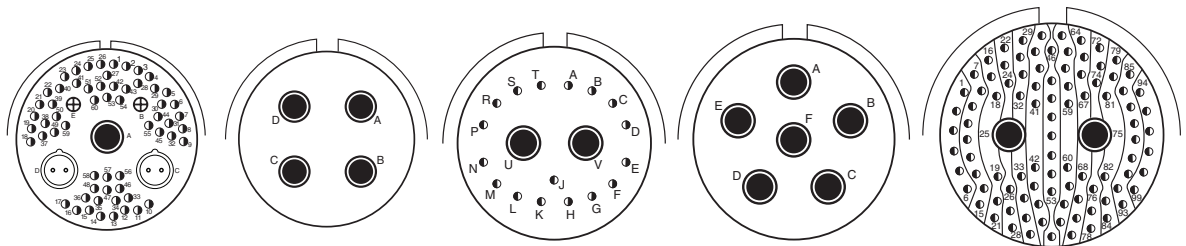

Insert Arrangement	21-65				21-75		21-79		23-6		25-7	
Number of Contacts	1				2		2		60		4	
Contact Size	8				10D		16		23		8	

CONTACT LEGEND



Quadrax or Differential Twinax

Insert Arrangements - for MIL-DTL-38999

Incorporating Octonet, Quadrax & Differential Twinax Contacts

Front face of pin inserts illustrated

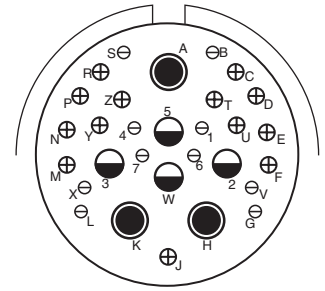
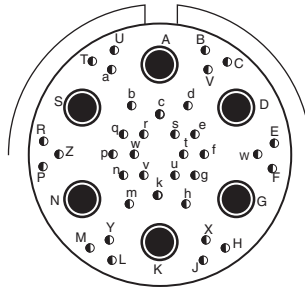
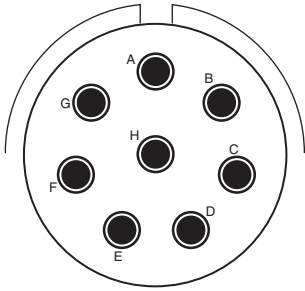

Insert Arrangement	25-8		25-17		25-20			
Number of Contacts	8		36	6	10	13	3	4
Contact Size	8		22D	8	20	16	8	12

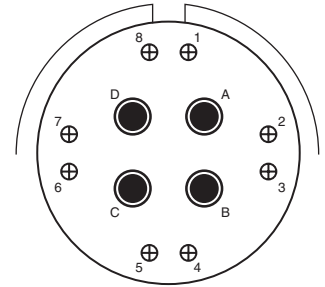
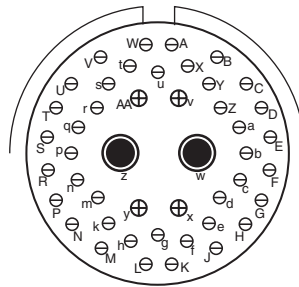
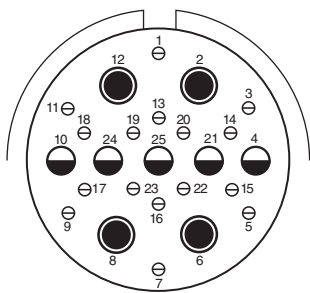

Insert Arrangement	25-26			25-46			25-62	
Number of Contacts	16	5	4	40	4	2	8	4
Contact Size	20	12	8	20	16	8	16	8

Ground plane only

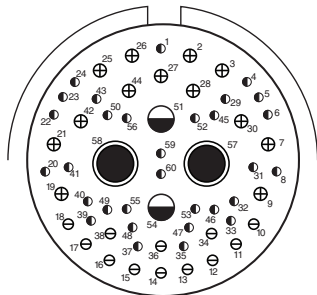

Insert Arrangement	25-AT				
Number of Contacts	2	2	13	12	31
Contact Size	8	12	16	20	22D

CONTACT LEGEND



OVERVIEW

Eight strategically spaced inner contacts form four 100 Ohm matched impedance differential pairs.



Pin for 24 awg

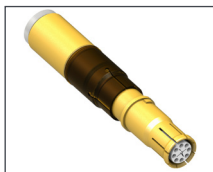

Socket for 24 awg

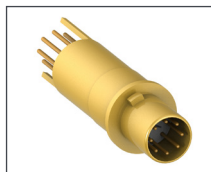

Pin PCB Tail

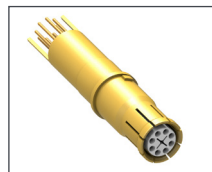

Socket PCB Tail



*Not limited to cables shown

FEATURES

- Available in size 8 crimp termination style
- Also available in PC Tails
- Can be installed in existing size 8 Quadrax cavities
- Meets performance specifications of CAT-6A cable
- 10G Ethernet compliant
- Overall higher bandwidth than standard CAT5E Quadrax-supports up to 4.0 Gbps per pair
- Enhanced crosstalk performance (compared to standard Quadrax)
- Supports wire ranges 26 to 24 gauge
- Requires modification of MIL-DTL-38999 connector to accommodate keyed contacts
- Operating Temp -65°C to 175°C
- Requires special backshell. See page 19 for backshell guide

BENEFITS

- Easy drop-in replacement to installed connectors no need to redesign
- Self removing contact feature - no extra contact extraction tool needed (24 Gauge only)

Pin	Socket	*Cable	AWG
21-032904-001	21-032905-001	Thermax: MX10G-24HP	24
21-032904-011	21-032905-011	W.L.Gore: RCN8966-24	
21-032904-021	21-032905-021	PIC E6A3824, Harbour E10024065, E10024064	
21-032904-031	21-032905-031	W.L.Gore: GSC-03-84043-01	
21-032904-041	21-032905-041	Axon P542810	
21-032904-051	21-032905-051	PIC E6A6826	
21-032904-061	21-032905-061	Thermax MX10G-24FLX4	
21-032904-061	21-032905-061	Thermax MX10G-24FLX4	
PCB Pin	PCB Socket	L Dimension + or - 15	
21-032906-001	21-032907-001	Pin .884 / Socket 1.024	
21-032906-011	21-032907-011	.884	
21-032906-021	21-032907-021	.884	
21-032906-031	21-032907-031	.950	
21-032906-041	21-032907-041	.859	
21-032906-051	21-032907-051	.518	
21-032906-061	21-032907-061	.788	

PCB L dimension length given in chart is the distance from the rear of the contact retention shoulder to the tip of the PCB tails.

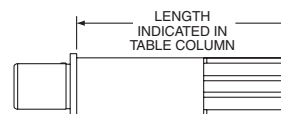

Note: it does not indicate stickout length when installed in D38999 connector.

SPECS

Environmental Sealing:	IAW connector specification
Corrosion Resistance:	500 hours salt spray
EMI Shielding:	360 degree shielding on each pair
Mating Cycles:	500 cycles
Voltage Rating:	500 Vrms max @ sea level
Dielectric Withstanding Voltage:	500 VAC RMS sea level

Octonet Contacts

Superior Ethernet Contact System for MIL-DTL-38999, Series III

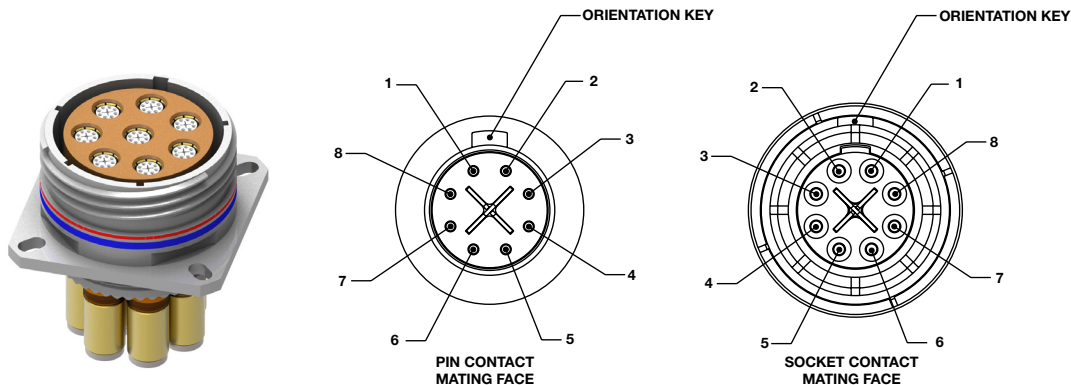

Differential Pairing	
Pair #	Contact ID
1	1-2
2	3-4
3	5-6
4	7-8

Part Number	Shell Size
FX-646409-01 ()	9
FX-646409-02 ()	11
FX-646409-03 ()	13
FX-646409-04 ()	15
FX-646409-05 ()	17
FX-646409-06 ()	19
FX-646409-07 ()	21
FX-646409-08 ()	23
FX-646409-09 ()	25

BACKSHELL EXTENDER

Due to the protrusion of the Octonet Contacts through the rear of the grommet, a Backshell Extender must be used. The Extender is compatible with any Mil-Spec Backshell. Consult the factory for more information.

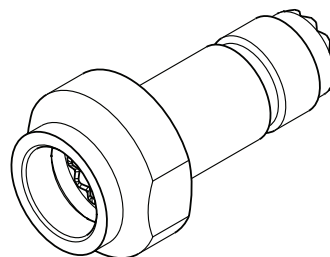

FINISH TABLE	
Prefix	Description
F2	Black Zinc Nickel
F4	Green Zinc Nickel
F7	Durmaol
F9	Thick OD Cadmium plate, Nickle Base
FH	Thick Electroless Nickel
FJ	Black Electroless Nickel

LENGTH TABLE	
Prefix	S ±.060
3	1.500
4	2.000
5	2.500
6	3.000
7	3.500
8	4.000
9	4.500

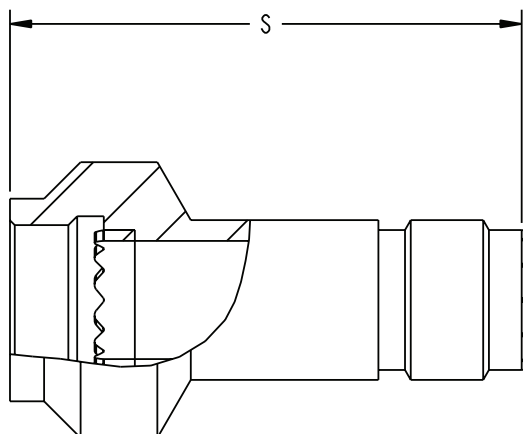

CONTACT DIFFERENTIAL INSERTION LOSS

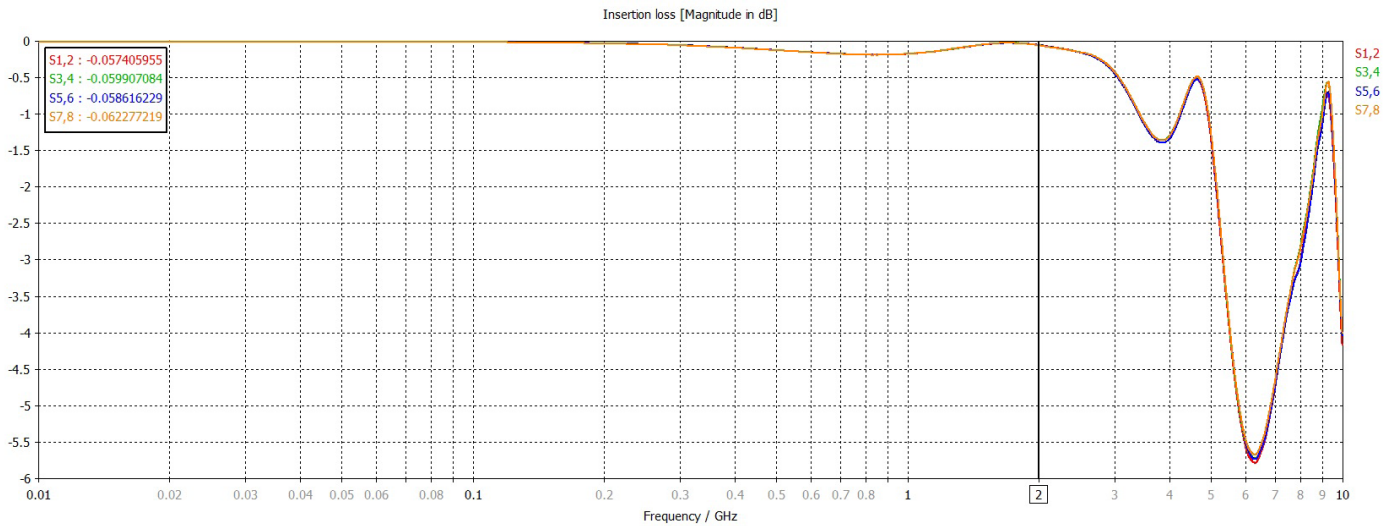

CONTACT DIFFERENTIAL RETURN LOSS

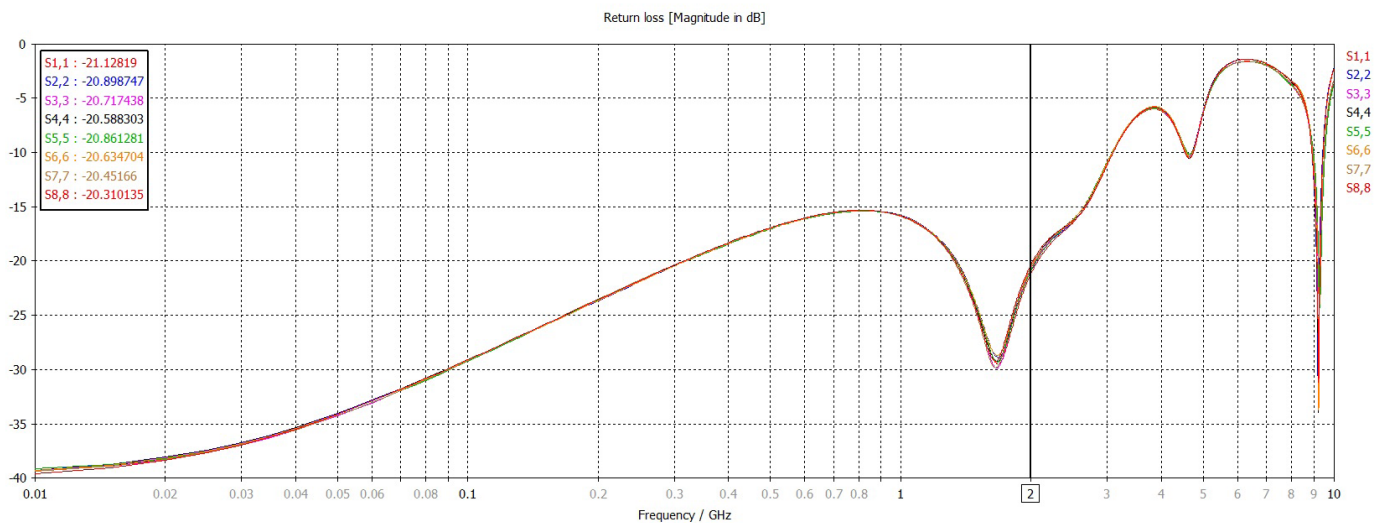

CONTACT DIFFERENTIAL REAR-END CROSSTALK

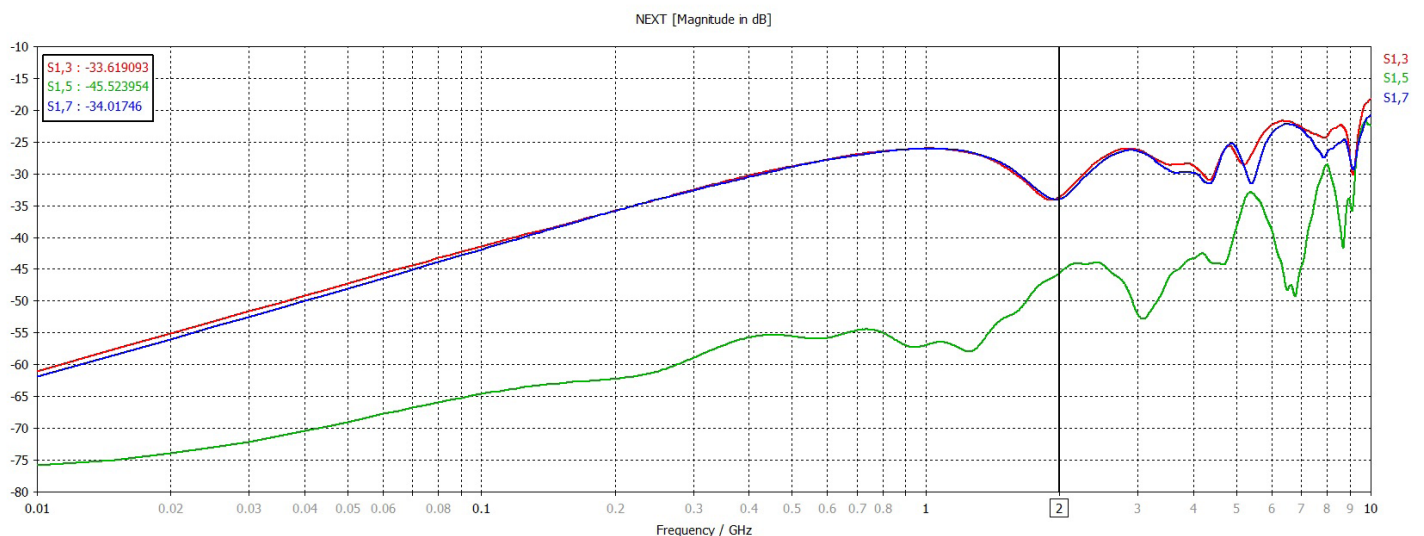

Signal Integrity Contact Data

10GBASE-T DATA (TWO MATED CONTACTS ON EACH END OF 100 METER CAT6A CABLE) INSERTION LOSS

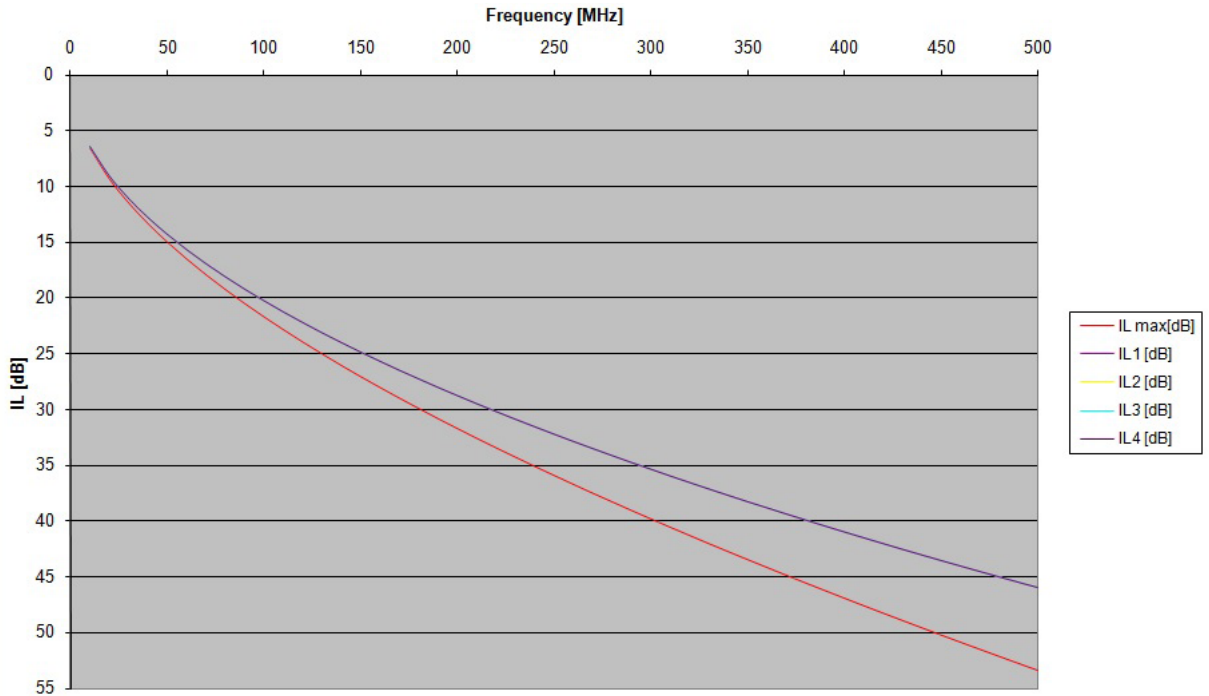

Cable assembly near-end crosstalk

RETURN LOSS

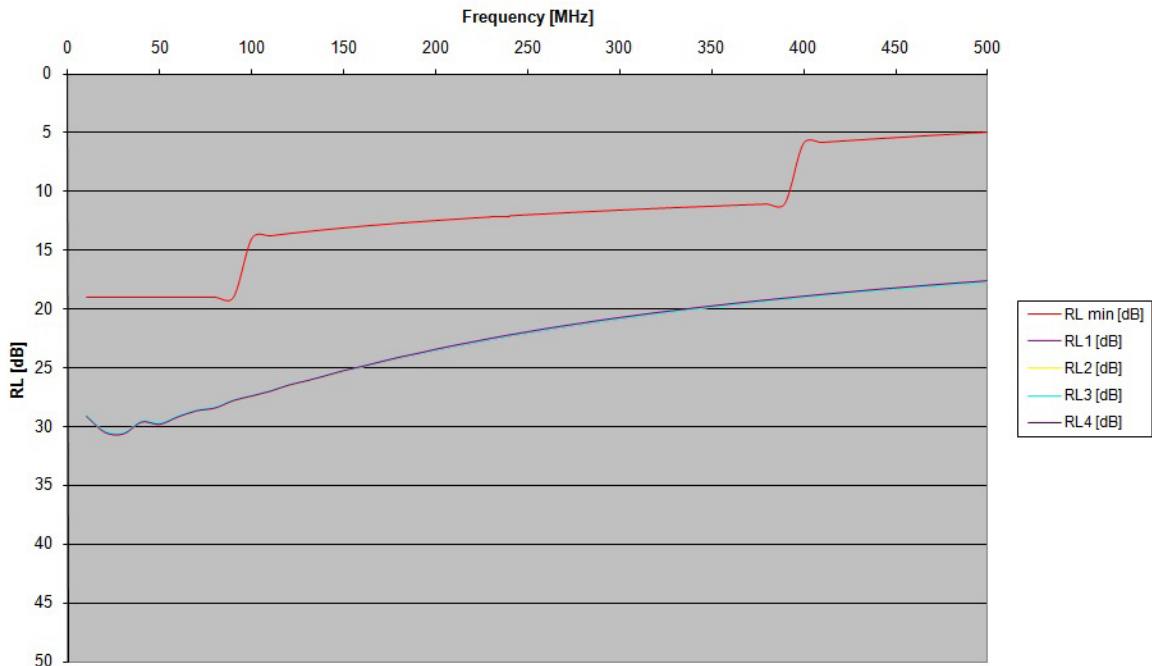

Cable assembly return loss

CTF-Quad (Copper to Fiber) Media Converter

Quadrx form factor pins

OVERVIEW

Amphenol Aerospace adds CTF-QUAD to the CTF (Copper to Fiber) media converter product family. This product line utilizes standard Quadrx receptacle connectors and inserts.

The CTF-QUAD product line is fiber to copper and copper to fiber media conversion in Quadrx form factor pins for standard D38999 Quadrx insert arrangements.

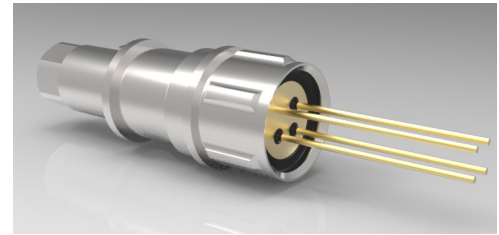

FEATURES

- Quadrx form factor embedded fiber optic transmitters and receivers
- Replace any Quadrx pin in receptacle and configure with media conversion copper to fiber and fiber to copper
- Utilizes standard Quadrx receptacle connectors and inserts

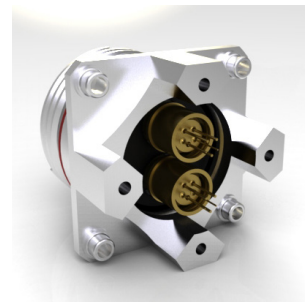

FIBER INTERFACE

- Industry standard 1.25mm fiber optic ferrules (LC & ARINC-801)
- Plug/socket side utilizes Quadrx socket to ARINC-801 pin adapter for system fiber connection

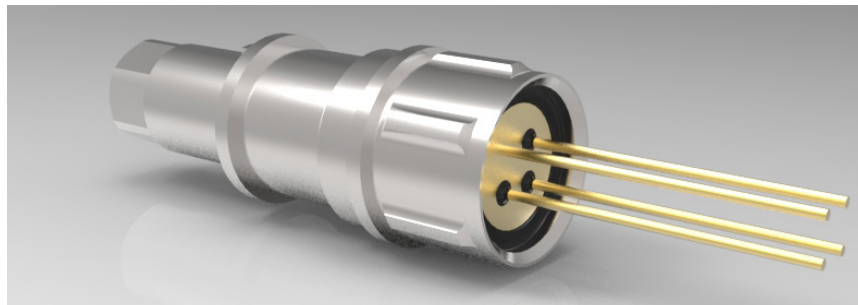

COPPER INTERFACE

- Speed support from DC to 10 Gbps in both transmitter and receiver
- PCB lead connection to customer circuit board or PCB lead connection to flex with nano

RUGGEDIZATION

- Industry standard rugged transmitters and receivers -40°C to +85°C
- Components epoxy sealed in place
- Refer to page 3 for additional details

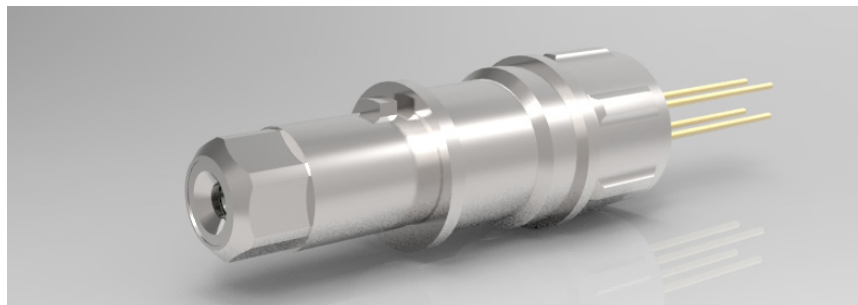

ARINC-801 SIZE 8 SOCKET ADAPTER

Quadrx ARINC-801 Fiber Adapter part number – CF-198201-000

Multi-mode ARINC-801 Termini for the Adapter – CF-198148-1128

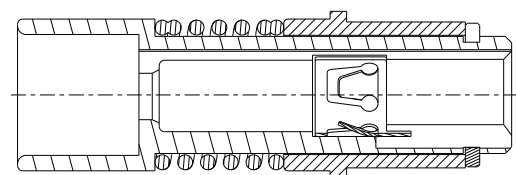
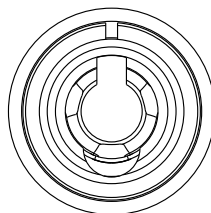
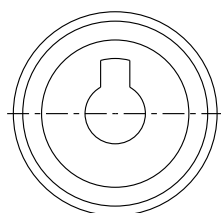
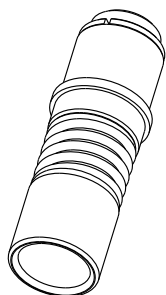

CTF-QUAD

How to Order

Ordering procedure is shown below using part number CTF-5Q90A1-04TN

1.	2.	3.	4.	5.	6.	7.	8.	9.
Connector Type	Material	Quadrax Contact	Finish	Shell Style	Shell Size-Insert Arrangement	Mode	Device Type	Rotation
CTF	5	Q	Z	0	A1	04	T	N

1. CONNECTOR TYPE	
CTF	Copper to Fiber Product Family

2. MATERIAL	
5	Aluminum Shell
6	Composite Shell
8	Stainless Steel Shell

3. QUADRAX CONTACTS	
Q	Quadrax Size 8 Contact Active Device

4. FINISH	
T	Aluminum Durmalon
Z	Aluminum Black Zinc Nickel
F	Aluminum Electroless Nickel
M	Composite Electroless Nickel
W	Aluminum OD Cad
J	Composite OD Cad
L	Stainless Steel Electrodeposited Nickel
Y	Stainless Steel Passivated*

* Environmental only-not hermetic

Note: There is not a Mil-Spec finish for environmental passivated steel-only hermetic, hence the asterisk.

5. SHELL STYLE	
0	Wall Mount
N	Wall Mount w/ Clinch Nuts
7	Jam Nut

Note: All with Stand-off

6. SHELL SIZE-INSERT ARRANGEMENT	
A1	9-5
E2	17-52
F4	21-75
H6	23-6
J8	25-8

7. MODE	
04	4 Gb/s multimode
08	8 Gb/s multimode
10	10 Gb/s multimode

8. DEVICE TYPE	
T	Transmit
R	Receive
X	Transceiver

9. ROTATION	
N	Normal
A	
B	
C	
D	
E	

CTF-QUAD MATING PLUG

Ordering procedure is shown below using part number CTF-5P96A1-000N (kit w/ connector and appropriate number of A801 cavity adapters)

1.	2.	3.	4.	5.	6.	7.
Connector Type	Material	Quadrax Contact	Finish	Shell Style	Shell Size-Insert Arrangement	Rotation
CTF	5	P	Z	6	A1	N

1. CONNECTOR TYPE	
CTF	Copper to Fiber Product Family

2. MATERIAL	
5	Aluminum Shell
6	Composite Shell
8	Stainless Steel Shell

3. QUADRAX CONTACTS	
P	Quadrax Size 8 Contact Adapter for ARINC 801 Contact

4. FINISH	
T	Aluminum Durmalon
Z	Aluminum Black Zinc Nickel
F	Aluminum Electroless Nickel
M	Composite Electroless Nickel
W	Aluminum OD Cad
J	Composite OD Cad
L	Stainless Steel Electrodeposited Nickel
Y	Stainless Steel Passivated*

5. SHELL STYLE	
6	Straight Plug

Note: No Stand-off, accessory threads

6. SHELL SIZE-INSERT ARRANGEMENT	
A1	9-5
E2	17-52
F4	21-75
H6	23-6
J8	25-8

7. ROTATION	
N	Normal
A	
B	
C	
D	
E	

* Environmental only-not hermetic

Note: There is not a Mil-Spec finish for environmental passivated steel-only hermetic, hence the asterisk.

AMPHENOL QUADRAX CONTACTS

Offers several advantages for high data transfer rates, low power consumption, and excellent EMI compatibility. Four strategically spaced inner contacts form two 100 or 150 Ohm matched impedance differential pairs. The Outer contact has a rugged wall section for durability. Available in size 8 crimp termination style. Also available in size 8 with PC tails (see pages 22-23). Requires modification of MIL-DTL-38999 connector to accommodate keyed contacts.

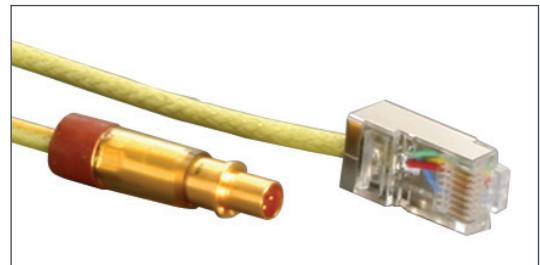

Quadrax Pin with 8P8C "RJ45" Jack

CABLE ILLUSTRATION - QUADRAX CONTACT

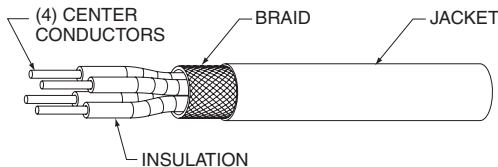

TYPICAL QUADRAX SOCKET CONTACT

Has socket outer contact with a socket inner contact

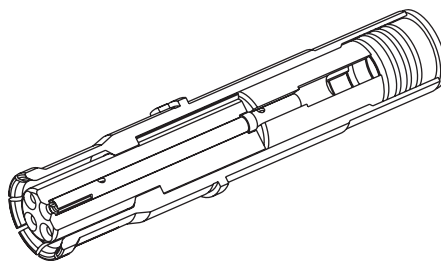

TYPICAL QUADRAX PIN CONTACT

Has pin outer contact with a pin inner contact

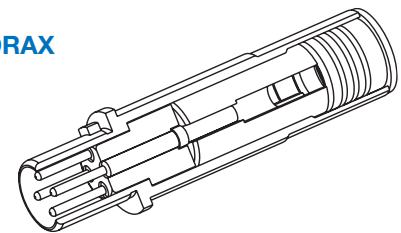

QUADRAX CONTACTS ARE GOLD PLATED, CRIMP TERMINATION

Finish of mating contact parts: supplied with 0.000050 min. gold over nickel on mating interface.

QUADRAX SIZE 8 CONTACT PERFORMANCE:

- Bandwidth:** Up to 1.25 GHz
- Data Rate:** Exceeding 2.5 Gbps.
- Voltage Rating:** 500 Vrms max. @ sea level

Dielectric Withstanding Voltage:

1000 VAC rms between all inner contacts @ sea level, 500 VAC rms between inner and outer contacts @ sea level

Suggested Numbering for Quadrax Contacts

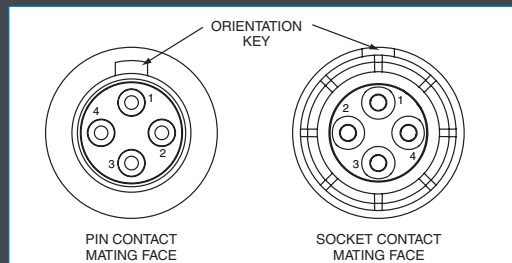

Differential Pairs, contacts 1-3, 2-4.

Quadrax differential pairs are 1 and 3, 2 and 4.

See page 19 for part number ordering of popularly used 38999 Series III connectors with 100 ohm quadrax contacts.

GUIDE FOR SELECTING A BACKSHELL:

See required backshell dimensions to avoid interference between piggyback grommets used on size 8 cavities and the backshell.

Backshell extender is also available see page 14. This can be used with any mil-spec backshell.

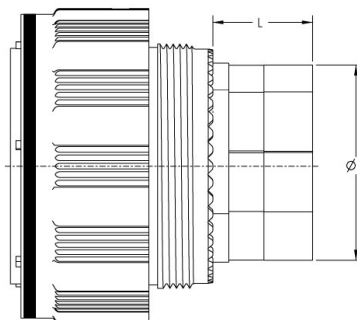

Size	A Dia Min	L Min
17	.734	.540
19	.869	.540
21	.869	.540
23	1.088	.540
25	1.234	.540

How to Order D38999, Series III Connectors with Standard 100 Ohm Quadrax Contacts

21-033385-051 Socket, 21-033384-051 Pin Contacts*

For all other quadrax contacts or differential twinax contacts, please consult Amphenol Aerospace for part numbers.

1.	2.	3.	4.	5.	6.
Connector Type	Shell Type	Service Class	Shell Size – Insert Arrangement	Contact Type	Alternate Keying Position
TVP	00	RQW	21-75	P	B

1. CONNECTOR TYPE	
TV	Tri-Start series connector with metal shells
TVP	Back panel mounted receptacle with metal shells
CTV	Tri-Start series connector with composite shells
CTVP	Back panel mounted receptacle with composite shells

2. SHELL STYLE	
00	Wall mount receptacle
02	Box mount receptacle available only with the PCB tails and epoxy backfilled (non-removable)
06	Straight plug
07	Jam nut receptacle

3. SERVICE CLASS WITH QUADRAX	
RQF	Electroless nickel plated
RGQF	Electroless nickel plated ground plane
RQW	Olive drab cadmium plate
RGQW	Olive drab cadmium plated ground plane
RQK	Corrosion resistance stainless steel
RGQK	Stainless steel ground plane
QDT	Durmalon plated, Nickel-PTFE alternative to cadmium
GQDT	Groundplane Durmalon
QDZ	Zinc nickel black conductive
RQS	Stainless steel
JFW	Aluminum Bronze

4. Select a Shell Size and Insert Arrangement
See insert arrangements available with Quadrax contacts on pages 11-12. Shell size and insert arrangements are together in one chart. First number represents shell size, second number is the insert arrangement.

5. CONTACT TYPE	
P	Pin contacts
S	Socket contacts

* The incorporation of Quadrax or Differential Twinax contacts requires a modified connector to accommodate keyed contacts.

6. Alternate Keying Position

Locksmith keying—rotation of minor keys. See Series III alternate positions below “N” not required for normal position.

Tri-Start Alternate Positions

A plug with a given rotation letter will mate with a receptacle with the same rotation letter. The angles for a given connector are the same whether it contains pins or sockets. Inserts are not rotated in conjunction with the master key/keyway.

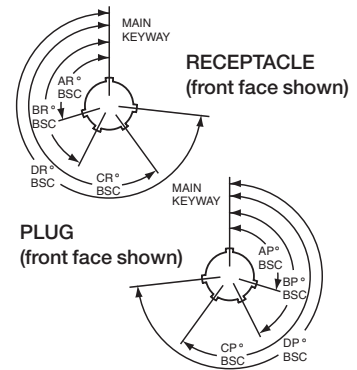

Shell Size	Key & Keyway Arrangement Identification Letter	AR° or AP° BSC	BR° or BP° BSC	CR° or CP° BSC	DR° or DP° BSC
9	N	105	140	215	265
	A	102	132	248	320
	B	80	118	230	312
	C	35	140	205	275
	D	64	155	234	304
11, 13, and 15	E	91	131	197	240
	N	95	141	208	236
	A	113	156	182	292
	B	90	145	195	252
	C	53	156	220	255
17 and 19	D	119	146	176	298
	E	51	141	184	242
	N	80	142	196	293
	A	135	170	200	310
	B	49	169	200	244
21, 23, and 25	C	66	140	200	257
	D	62	145	180	280
	E	79	153	197	272
	N	80	142	196	293
	A	135	170	200	310
25L, 33, and 37	B	49	169	200	244
	C	66	140	188	257
	D	62	145	188	280
	E	79	153	188	272
	N	80	142	188	293

QUADRAX CONTACTS FOR USE IN TV-R CONNECTORS					
Impedance (Ohms)	Inner Conductor (AWG)	Electrical Protocol††	Cable	Contact Part Number (Termination Instruction Sheet)**	
				Pin	Socket
90		USB2.0 (480 Mbps)	USB2 (28433/02171LX-4)	21-033384-101† (L-2119-EK)	21-033385-101† (L-2119-EK)
	24		PIC USB2422	21-033384-381 (L-2119-EU)	21-033385-381 (L-2119-EU)
100	22	Ethernet (100 Mbps), 1000 Base-T Gigabit Ethernet (1 Gbps)	GORE RCN 7688	21-033384-061 (L-2119-H)	21-033385-061 (L-2119-H)
			NF22Q100-01		
			Tensolite NF22Q100		
			Thermax 956-5		
		Ethernet (100 Mbps), 1000 Base-T Gigabit Ethernet (1 Gbps)	Gore RCN8513	21-033384-171 (L-2119-BN)	21-033385-171 (L-2119-BN)
			JSFY18-3		
Ethernet (100 Mbps), 1000 Base-T Gigabit Ethernet (1 Gbps)	Tensolite NF22Q100 Special Box pattern, only mates with 21-03333()-181	21-033384-181 (L-2119-BP)	21-033384-181 (L-2119-BP)		
100	24		S280W502-4/BMS13-72T03C04G024	21-033384-141 (BACC47GM1)	21-033385-141 (BACC47GN1)
		Ethernet (100 Mbps), 1000 Base-T Gigabit Ethernet (1 Gbps)	Tensolite NF24Q100-01 (same as 21-033338()-51, uses EMI Piggyback)	21-033384-161 (L-2119-BE)	21-033385-161 (L-2119-BE)
		Ethernet, 1000 Base-T Gigabit Ethernet	ABS0972 KB24	21-033384-021 (L-2119-A)	21-033385-021 (L-2119-A)
			ABS1503 KD 24		
			Draka Fileca F-4703-3		
			Draka Fileca F-4704-5		
			F4704-4		
			Filotex ET 2PC236		
			Filotex ET 2PF870		
			PIC Wire E50424		
		Tensolite 23450/04090X-4(LD)			
		Ethernet, 1000 Base-T Gigabit Ethernet	24443/03130X-4(LD)	21-033384-051 (L-2119-D)	21-033385-051 (L-2119-D)
			24443/03166X-4(LD)		
			24443/9P025X-4(LD)		
			24443/C20714X-4(LD)		
			24450/0120X-4(LD)		
			BMS13-72T03C04G024		
			GORE GSC-01-81869-01		
			NF24-2Q100		
			NF24Q100-01		
			NF24Q100-01-200C (Space)		
			Pic Wire E51424		
			S280W502-4		
			Tensolite NF24Q100		
			Thermax MX100Q-24		
			Thermax T956-4T200		
		TYCO CEC-RWC-18664			
		Harbour Q10024016			
Serial FPDP Applications (2.5 Gbps) (Typical app run at 150 Ohms) HDMI 1.3	Tensolite NF24Q100	21-033384-191 (L-2119-BS)	21-033385-191 (L-2119-BS)		
Meets EN3155-074	ABS1503KD24	21-033384-281 (L-2119-DL)	21-033385-281 (L-2119-DL)		
	F-4703				
	Gore RCN9034	21-033384-391 (L-2119-EY)	21-033385-391 (L-2119-EY)		
	NF24Q100-01				
	Gore RCN8752	21-033384-421	21-033385-421		
	Madison 1016423	21-033384-431	21-033385-431		

Quadrax Contacts

MIL-DTL-38999, Series III*, Contact Part Number Guide by Cable

QUADRAX Contacts

QUADRAX CONTACTS FOR USE IN TV-R CONNECTORS					
Impedance (Ohms)	Inner Conductor (AWG)	Electrical Protocol††	Cable	Contact Part Number (Termination Instruction Sheet)**	
				Pin	Socket
100	26	Ethernet (100 Mbps), 1000 Base-T Gigabit Ethernet (1 Gbps)	PIC E51426	21-033384-071 (L-2119-AB)	21-033385-071 (L-2119-AB)
			Tensolite NF26-2Q100		
			Tensolite NF26Q100		
			Tensolite NF26Q100-01		
		Wirenetics W-3714-379			
		Ethernet (100 Mbps), 1000 Base-T Gigabit Ethernet (1 Gbps)	Draka Fileca F-4704-6	21-033384-151 (L-2119-AW)	21-033385-151 (L-2119-AW)
Gore RCN 8672					
110	24		Cable RCN 8422	21-033384-291 (L-2119-DR)	21-033385-291 (L-2119-DR)
			Gore RCN 8647	21-033384-301 (L-2119-DR)	21-033385-301 (L-2119-DR)
			Gore RCN 8687		
		IEEE 1394B Firewire	Gore RCN8647	21-033384-211 (L-2119-CD)	21-033385-211 (L-2119-CD)
			Tensolite 24450/03089X-4(LD)		
		IEEE 1394B Firewire	JSFY02-1	21-033384-221 (L-2119-FF)	21-033385-221 (L-2119-FF)
			JSFY18		
		IEEE 1394B Firewire	Gore RCN8487	21-033384-231 (L-2119-CR)	21-033385-231 (L-2119-CR)
			JSFY18		
		IEEE 1394B Firewire	Tensolite 24450/03089X-4(LD) Same as 21-03338()-211 but Box pattern, mates with 21-03338()-241 only	21-033384-241†	21-033385-241†
150	24		Gore RCN7625	21-033384-271 (L-2119-CT)	21-033385-271 (L-2119-CT)
			Harbour Data Master Q150-24 (19)	21-033450-051 (L-2119-DV)	21-033451-051 (L-2119-DV)
	Tensolite 24483/02006X-4 (LD)				
	26		Tensolite 26473/02006X-4(LD)/Gore RCN8328 (not for new designs, use 21-033450/1 series)	21-033384-031 (L-2119-B)	21-033385-031 (L-2119-B)
			Gore RCN8328		
		Tensolite 26473/02006X-4(LD) Same as 21-033384/5-31 but box pattern (not for new designs, use 21-033450/1 series) Gore RCN8328	21-033384-201†	21-033385-201†	
		Fibre-Channel (1 GBPS, 2 GBPS, 1G/2G), 1000 Base-CX (1.25 GBPS), SCSI-2 (3.2 GBPS)	Gore RCN8328	21-033450-001 (L-2119-BW)	21-033451-001 (L-2119-BW)
			Tensolite 26473/02006X-4(LD)		
		Fibre-Channel (1 GBPS, 2 GBPS, 1G/2G), 1000 Base-CX (1.25 GBPS), SCSI-2 (3.2 GBPS)	Gore RCN8328 (same as 21-033450/1-1 except box pattern). Mates with 21-033450/1-11 only.	21-033450-011† (L-2119-CS)	21-033451-011† (L-2119-CS)
			Tensolite 26473/02006X-4(LD)		
			Harbour Data Master Q150-24(19)SS	21-033450-051 (L-2119-DV)	21-033451-051 (L-2119-DV)
		Gore RCN7625	21-033450-061 (L-2119-GH)	21-033451-061 (L-2119-GH)	

Daniels crimping tools are available from Daniels Mfg. Corp. 6103 Anno Ave., Orlando, FL 32809

* Requires modified connector to accommodate keyed contacts.

** Termination instructions are packaged with each contact and can be found on-line at: www.amphenol-aerospace.com/serviceinstructions.asp

† Consult Amphenol Aerospace for current release of this contact or instruction sheet if applicable.

†† Test reports available for indicated protocols. Consult Amphenol Aerospace.

QUADRAX PCB CONTACTS					
Impedance (Ohms)	L Dim	Pretinned	Contact Part Number		
			Pin	Socket	
100	.36		21-033398-391	21-033397-391	
	.418		21-033398-491	21-033397-491	
	.428 ± .015		21-033398-751	21-033397-751	
	.494		21-033398-231	21-033397-231	
	.552 ± .015		21-033398-741	21-033397-741	
	.582		21-033398-521	21-033397-521	
	.580 ± .015		21-033398-661	21-033397-661	
	.605		21-033398-191	21-033397-191	
	.615		21-033398-141	21-033397-141	
	.647 ± .015		21-033398-761	21-033397-761	
	.666		21-033398-531	21-033397-531	
	.672		21-033398-371	21-033397-371	
	.689 ± .015		21-033398-721	21-033397-721	
	100/150	.699		21-033398-511	21-033397-511
	100	.708		21-033398-111	21-033397-111
.721			21-033398-581	21-033397-581	
.740 ± .015			21-033398-771	21-033397-771	
.741			21-033398-241	21-033397-241	
.741			21-033398-271	21-033397-271	
.761			21-033398-461	21-033397-461	
.770 ± .015			21-033398-691	21-033397-691	
.775			21-033398-221	21-033397-221	
.788		X	21-033398-551	21-033397-551	
.788			21-033398-251	21-033397-251	
.788 ± .015			21-033398-731	21-033397-731	
.806			21-033398-281	21-033397-281	
.815			21-033398-561	21-033397-561	
.815 ± .015			21-033398-631	21-033397-631	
.819			21-033398-431	21-033397-431	
.836			21-033398-301	21-033397-301	
.84		X	21-033398-091	21-033397-091	
.859			21-033398-121	21-033397-121	
.866			21-033398-031	21-033397-031	
.866 ± .015			21-033398-681	21-033397-681	
.871			21-033398-351	21-033397-351	
.875			21-033398-501	21-033397-501	
.889			21-033398-471	21-033397-471	

QUADRAX PCB CONTACTS				
Impedance (Ohms)	L Dim	Pretinned	Contact Part Number	
			Pin	Socket
100	.901		21-033398-341	21-033397-341
	.914		21-033398-381	21-033397-381
	.928 ± .015		21-033398-641	21-033397-641
	.928 ± .015		21-033398-671	21-033397-671
	.939		21-033398-601	21-033397-601
	.939		21-033398-361	21-033397-361
100/150	.939		21-033398-591	21-033397-591
100	.94		21-033398-311	21-033397-311
	.946		21-033398-541	21-033397-541
	.971		21-033398-481	21-033397-481
	.991 ± .015		21-033398-701	21-033397-701
	1.009		21-033398-401	21-033397-401
	1.035	X	21-033398-021	21-033397-021
	1.035		21-033398-291	21-033397-291
	1.035 ± .015		21-033398-651	21-033397-651
110	1.169		21-033398-421	21-033397-421
	1.196 ± .015		21-033398-621	21-033397-621
	1.366		21-033398-611	21-033397-611
	TBD		21-033398-711	21-033397-711

Daniels crimping tools are available from Daniels Mfg. Corp. 6103 Anno Ave., Orlando, FL 32809

* Requires modified connector to accommodate keyed contacts.

Indicated length given in chart is the distance from the rear of the contact retention shoulder to the tip of the PCB tails.

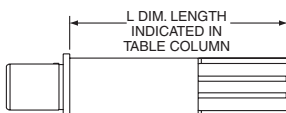

Note: It does not indicate stickout length when installed in D38999 connector.

Quadrax Contacts

MIL-DTL-38999, Series III*, Contact Part Number Guide for PCB Contacts

QUADRAX PCB CONTACTS				
Impedance (Ohms)	L Dim	Pretinned	Contact Part Number	
			Pin	Socket
150	.494 (mates to 21-033450/51 series)		21-033452-051	21-033453-051
	.494		21-033398-451	21-033397-451
	.494	X	21-033398-071	21-033397-071
	.582 (mates to 21-033450/51 series)		21-033452-061	21-033453-061
	.699		21-033398-511	21-033397-511
	.780	X	21-033398-081	21-033397-081
	.780	X	21-033398-131	21-033397-131
	.815		21-033398-151	21-033397-151
	.815	X	21-033398-211	21-033397-211
	.815 (mates to 21-033450/51 series)		21-033452-021	21-033453-021
	.815 (mates to 21-033450/51 series)	X	21-033452-031	21-033453-031
	.866		21-033398-411	21-033397-411
	.866 (mates to 21-033450/51 series)		21-033452-041	21-033453-041
	.939		21-033398-591	21-033397-591
	.939 (mates to 21-033450/51 series)		21-033452-071	21-033453-071
	1.035 (mates to 21-033450/51 series)		21-033452-011	21-033453-011
	1.035		21-033398-061	21-033397-061

Daniels crimping tools are available from
Daniels Mfg. Corp. 6103 Anno Ave., Orlando, FL 32809

* Requires modified connector to accommodate keyed contacts.

*** Must be used with 21-033321-005 piggyback grommet seal.

SEALING PLUGS	
Sealing Plugs for use with D38999 Connectors using Quadrax Contacts - Size 8 Cavities	Part Number
***Standard Plastic (Not recommended for Pin Connectors)	T3-4008-59P
Standard Plastic to be used with PCB tails (shorter tail length)	T3-4008-59P1
***Metal sealing plug - can be used when mating with contacts on mating half	21-033899-8Q1
Metal sealing plug used with PCB's and mating contact on mating half	21-033899-8Q2

PIGGYBACK GROMMET	
Grommet for use with D38999 using Quadrax Contacts	Part Number
Metallized piggyback grommet	21-033321-023

Quadrax Transition Adapters

General Description

AMPHENOL TRANSITION ADAPTERS

Are used to facilitate launching of controlled impedance signals to printed circuit boards. Amphenol provides transition adapters in both contact types:

- Quadrax transition adapters, 90° or straight receptacles threaded or cable to board style

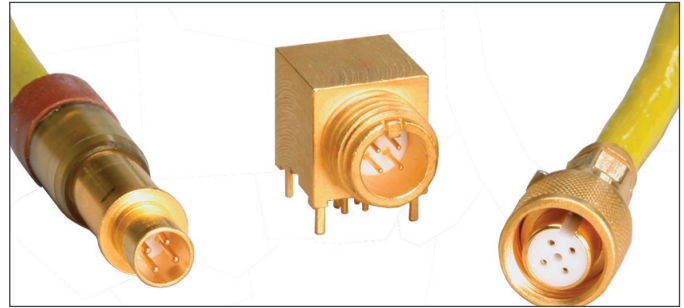

90° Quadrax Receptacle and Plug Transition Adapter

SUGGESTED NUMBERING FOR TRANSITION ADAPTERS WITH QUADRAX CONTACTS

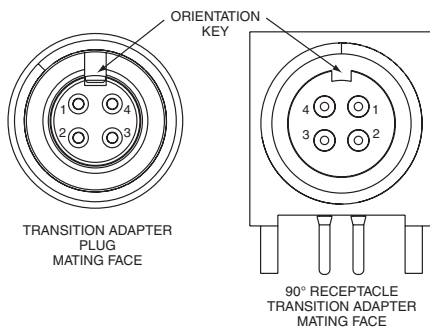

QUADRAX Adapters

ELECTRICAL PROTOCOLS FOR QUADRAX TRANSITION ADAPTERS

Impedance (Ohms)	Electrical Protocol††	Part Number	
		Plug	Receptacle
100	Ethernet, Gigabit Ether	21-033836-031	
	Ethernet, Gigabit Ether	21-033836-041	
	Ethernet, Gigabit Ether	21-033836-051	
	Ethernet, Gigabit Ether	21-033836-061	
		21-033837-101	
			21-033837-081 (90°)
			21-033837-091 (straight)
			21-033837-041 (90°)
	Ethernet, Gigabit Ether		21-033837-051 (straight)
150			21-033837-061 (90°)
			21-033837-141 (90°)
	1000 Base CX, Fibre channel	21-033836-021	
		21-033837-111	
	1000 Base CX, Fibre channel		21-033837-021 (90°)
			21-033837-211 (jam nut)
		21-033837-031 (straight)	
		21-033837-071 (90°)	

QUADRAX TRANSITION ADAPTER PLUG

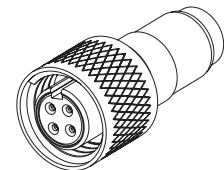

QUADRAX TRANSITION ADAPTER 90 DEGREE RECEPTACLE

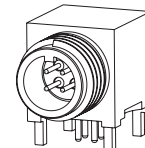

††Test reports available for indicated protocols; consult Amphenol Aerospace.

Quadrax Transition Adapters

MIL-DTL-38999, Series III, Part Number Guide

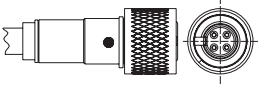
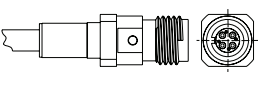
100 OHM QUADRAX TRANSITION ADAPTERS FOR LAUNCHING CONTROLLED IMPEDANCE SIGNALS TO PC BOARDS						
Illustration of Adapter	Impedance (Ohms)	Quadrax Type Adapter/ Cable or PCB Tail Length	Mating Thread Size	Part Number (Termination Instruction Sheet)**		
				Plug	Receptacle	
	100	Quadrax Plug Adapter/ 24443/03130X-4(LD)	.375	21-033836-031 (L-2119-U)		
		24443/9P025X-4(LD)				
		NF24Q100-01				
		S280W502-4				
		Tensolite NF24Q100				
		Thermax 956-4TN				
		Quadrax Plug Adapter/ Draka Fileca F-4704-5			21-033836-041 (L-2119-W)†	
		NF22Q100-01				
		Tensolite NF22Q100				
		Tensolite 24450/030894-4(LD)				
		Thermax 956-5				
		Quadrax Plug Adapter/ Draka Fileca F-4703-3, F-4704-4		21-033836-051 (L-2119-Y)		
		Quadrax Plug Adapter/ NF26Q100		21-033836-061 (L-2119-AM)†		
		Gore RCN8724 (30 awg)		21-033836-071		
		Gore ACN1042 (28 awg)		21-033836-101		
		Gore RCN8973		21-033836-121		
		Draka Fileca F4703-3, F-4704-4		21-033836-131		
		Gore RCB8422		21-033836-131		
		Gore RCN8422		21-033836-141		
		Gore RCN8982		21-033836-151		
Draka Fileca F4704-06	21-033836-081					
Quadrax Plug Adapter/ Hexnut with Lock Wire Holes Tensolite RCN8467	21-033836-111					
Tensolite NF24Q100-01						
	100	Quadrax Receptacle Straight Adapter in-line jam nut (threaded)/ GSC-10-8273900		21-033837-081 (L-2119-AR)†		
		Quadrax Receptacle Straight Adapter in-line jam nut (threaded)/ Tensolite NF24Q100-01		21-033837-261		
		Quadrax Receptacle Straight Adapter in-line (threaded)/ NF24Q100	21-033837-091 (L-2119-BL)			
		S280W502-4				
		Tensolite 24443/03130X-4 (LD)				
		Tensolite 24443/9P025X -4 (LD)				
		Tensolite NF24Q100-01				
		Thermax 956-4TN				
		NF26Q100-01				
				21-033837-341		

Daniels crimping tools are available from Daniels Mfg. Corp. 6103 Anno Ave., Orlando, FL 32809

† Consult Amphenol Aerospace for current release of this adapter & instruction sheet if applicable. See electrical protocols for transition adapters on page 24

** Termination instructions are packaged with each contact and can be found on-line at: www.amphenol-aerospace.com/serviceinstructions.asp

Quadrax Transition Adapters

MIL-DTL-38999, Series III, Part Number Guide

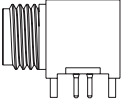
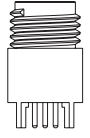
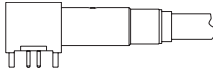
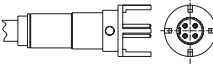
100 OHM QUADRAX TRANSITION ADAPTERS FOR LAUNCHING CONTROLLED IMPEDANCE SIGNALS TO PC BOARDS						
Illustration of Adapter	Impedance (Ohms)	Quadrax Type Adapter/ Cable or PCB Tail Length	Mating Thread Size	Part Number (Termination Instruction Sheet)**		
				Plug	Receptacle	
 	100	PCB Quadrax Receptacle 90 Degree Adapter/ Tail Length .110	.375		21-033837-041	
		PCB Quadrax Receptacle 90 Degree Adapter/ Tail Length .200			21-033837-201	
		PCB Quadrax Receptacle Straight Adapter/ Tail Length .110			21-033837-051	
		PCB Quadrax Receptacle Straight Adapter/ Special Tail Length (.200)			21-033837-061	
		Straight adapter/ Tail Length .175			21-033837-131	
		PCB Quadrax Receptacle Straight Adapter/ Tail Length .110 except .019" diameter inner contact tails			21-033837-291	
 	100	Quadrax Receptacle 90 degree Adapter with cable to board/ NF24Q100 Tail Length .110			21-033837-141 (L-2119-BB)†	
		Quadrax Receptacle 90 degree Adapter with cable to board/			21-033837-231	
		ABS1503KD24 Tail Length .110				
		Tensolite NF22Q100-01				
		Thermax 956-5				
		Draka Fileca F4704-5				
		Quadrax Receptacle Straight Adapter with cable to board/ NF24Q100, NF24Q100-01 Tail Length .195				21-033837-101 (L-2119-AN)
		Quadrax receptacle straight adapter w/ cable to board/ Tail length .195 Draka Fileca F-4703-3, F-4703-4				21-033837-241

Daniels crimping tools are available from
Daniels Mfg. Corp. 6103
Anno Ave., Orlando, FL 32809

** Termination instructions are packaged with each contact and can be found on-line at:
www.amphenol-aerospace.com/serviceinstructions.asp

† Consult Amphenol Aerospace for current release of this adapter and instruction sheet if applicable. See electrical protocols for transition adapters on page 24.

Quadrax Transition Adapters

MIL-DTL-38999, Series III, Part Number Guide

150 OHM QUADRAX TRANSITION ADAPTERS FOR LAUNCHING CONTROLLED IMPEDANCE SIGNALS TO PC BOARDS						
	Illustration of Adapter	Impedance (Ohms)	Quadrax Type Adapter/ Cable or PCB Tail Length	Mating Thread Size	Part Number (Termination Instruction Sheet)**	
					Plug	Receptacle
Mating plugs and receptacles		150	Quadrax Plug Adapter/ Tensolite 26473/02006X-4(LD), Gore RCN8328	.375	21-033836-021 (L-2119-S)	
			PCB Quadrax Receptacle 90 Degree Adapter/ Tail Length .110			21-033837-021
			PCB Receptacle 90 Degree Adapter/ Tail Length .200			21-033837-251
			PCB Quadrax Receptacle Straight Adapter/ Tail Length .110			21-033837-031
Wired to board		150	Quadrax Receptacle Straight Adapter in-line Jam Nut (threaded)/ Tensolite 26473/02006X-4 (LD), Gore RCN8328			21-033837-211 (L-2119-BY)
			Quadrax Receptacle 90 degree Adapter with cable to board/ Tensolite 26473/02006X-4			21-033837-071 (L-2119-AI)†
			Quadrax Receptacle Straight Adapter with cable to board/ Tensolite 26473/02006X-4 (LD)			21-033837-111 (L-2119-AP)

Daniels crimping tools are available from
Daniels Mfg. Corp. 6103 Anno Ave., Orlando, FL 32809

** Termination instructions are packaged with each contact and can be found on-line at:
www.amphenol-aerospace.com/serviceinstructions.asp

† Consult Amphenol Aerospace for current release of this adapter and instruction sheet
if applicable. See electrical protocols for transition adapters on page 24.

Split-Pair Quadrax Contacts & Cables

Features & Benefits/ How to Order

“SPLIT-PAIR” FOR USE WITH CAT6A TYPE CABLE

AMPHENOL AEROSPACE OFFERS THE HIGH PERFORMANCE INTERCONNECT SOLUTION FOR CAT6A TYPE CABLE.

FEATURES & BENEFITS:

- Overall higher bandwidth than standard CAT5E quadrax - Supports up to 6.5 Gbps per pair
- Enhanced crosstalk performance (compared to standard quadrax) due to compatibility with shielded twisted pair of cables
- Can be used for a variety of high speed applications beyond current quadrax design
- Four strategically spaced inner contacts form two 100 Ohm matched impedance differential pairs
- Outer contact has rugged wall section for durability
- Available in size 8 crimp termination style
- Also available in size 8 PC tails
- Can be installed into existing quadrax contact connector cavities
- Requires modification of MIL-DTL-38999 connector to accommodate keyed contacts

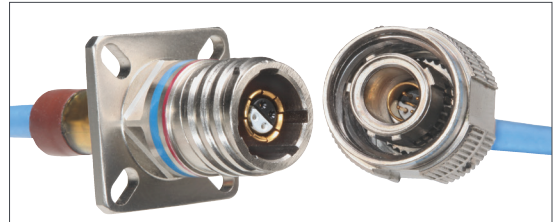

MIL-DTL-38999 Series III Connectors with “Split-Pair” Quadrax Contacts for use with CAT6A Type Cable

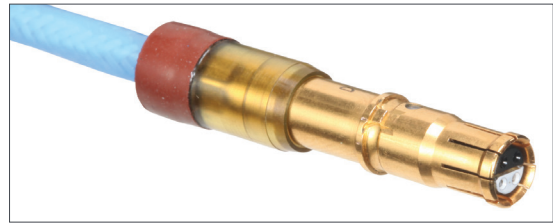

“Split-Pair” Quadrax Contacts for use with CAT6A Type Cable

APPLICATIONS:

For use with, but not limited to, the following electrical protocols:

- 10/100/1000/10GBASE-T Ethernet
- DVI
- USB 2.0, 3.0
- Serial Rapid IO (up to 3.125 Gbps)
- PCI-Express 2.0
- HDMI 1.3a
- SATA 2.0 (up to 3 GHz)

SUGGESTED NUMBERING FOR QUADRAX CONTACTS

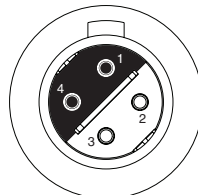

PIN CONTACT MATING FACE

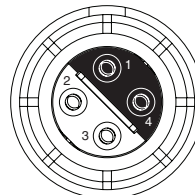

SOCKET CONTACT MATING FACE

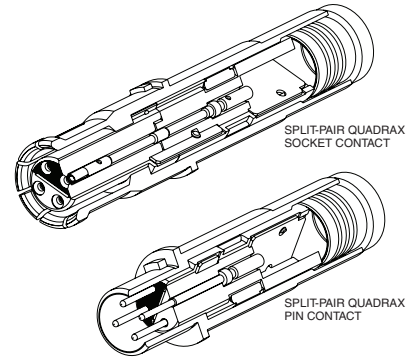

SPLIT-PAIR QUADRAX SOCKET CONTACT

SPLIT-PAIR QUADRAX PIN CONTACT

Differential Pairs: 1 & 4, 2 & 3

Cable selection may limit data rate of above protocols

Patent approved

Impedance (Ohm)	Inner Conductor	Inner Contact Layout*	Cable Part #	Notes	Part Number	
					Pin	Socket
100	24	Box	Thermax-1536-224		21-033470-031	21-033471-031
			Thermax-1536-224	Space Grade	21-033470-081	21-033471-081
			Gore RCN9007-24		21-033470-131	21-033471-131
			Gore RCN9007-24	Space Grade	21-033470-151	21-033471-151
		Diamond	Thermax-1536-224		21-033470-001	21-033471-001
			Tensolite 24463/9P025X-2(LD)	**SPECIAL** Only uses one of the pairs, only supplied with 2 inners	21-033470-061	21-033471-061
			Thermax-1536-224		21-033470-071	21-033471-071
			Gore RCN9062		21-033470-091	21-033471-091
	26	Box	Thermax-1536-195		21-033470-051	21-033471-051
		Diamond	Thermax-1536-195		21-033470-021	21-033471-021
	28	Box	Gore RCN9007-28		21-033470-141	21-033471-141
			Gore RCN9007-28	Space Grade	21-033470-161	21-033471-161
		Diamond	Tempflex V5026 (twinax)	Space Grade	21-033470-201	21-033471-201
			Gore RCN9007-28		21-033470-101	21-033471-101
			Gore RCN9007-28	Space Grade	21-033470-121	21-033471-121

*Note: Default in D38999 style connector is diamond inner contact layout. Box pattern is mainly used in rectangular connectors when mating to 90 degree PCB tails installed in rectangular connector configuration.

Split-Pair Quadrax Contacts

PCB Contacts & Transition Adapter Contacts

QUADRAX Split Pair

Impedance (Ohm)	Length ±.015	PCB Pin Part Numbers	PCB Socket Part Numbers
100	0.45	21-033466-121	21-033467-121
	0.494	21-033466-051	21-033467-051
	0.582	21-033466-061	21-033467-061
	0.621	21-033466-191	21-033467-191
	0.741	21-033466-141	21-033467-141
	0.741	21-033466-161	21-033467-161
	0.77	21-033466-131	21-033467-131
	0.815	21-033466-021	21-033467-021
	0.815	21-033466-031*	21-033467-031*
	0.815	21-033466-071	21-033467-071
	0.840	21-033466-081	21-033467-081
	0.847	21-033466-181	21-033467-181
	0.847	21-033466-091	21-033467-061
	0.866	21-033466-041	21-033467-041
	0.88	21-033466-111	21-033467-111
	0.973	21-033466-151	21-033467-151
	1.035	21-033466-011	21-033467-011
	1.208	21-033466-101	21-033467-101

Indicated length given in charts is the distance from the rear of the contact retention shoulder to the tip of the PCB tails.

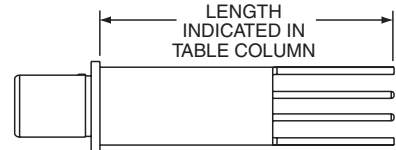

Note: it does not indicate stickout length when installed in D38999 connector.

*Pretinned

100 OHM SPLIT PAIR QUADRAX TRANSITION ADAPTERS FOR LAUNCHING CONTROLLED IMPEDANCE SIGNALS TO PC BOARDS

Illustration of Adapter	Impedance (Ohms)	Quadrax Type Adapter/ Cable or PCB Tail Length	Notes	Part Number	
				Plug	Receptacle
<p>Mating plugs and receptacles</p>	100	Quadrax Plug Adapter/ Thermax 1536-224		21-033468-011	
		Thermax (24 AWG)-1536-224		21-033468-021	
		Thermax (24 AWG)-1536-195		21-033468-031	
		Gore RCN9062	With nut flats and lock wire holes	21-033468-041	
		Gore RCN9007-28	With nut flats and lock wire holes	21-033468-051	
		Gore RCN9007-24	Space Grade with nut flats and lock wire holes	21-033468-061	
		Gore RCN9007-28	Space Grade with nut flats and lock wire holes	21-033468-071	
		PCB Quadrax Receptacle 90 Degree Adapter/ Tail Length .110			21-033469-001
		PCB Quadrax Receptacle 90 Degree Adapter/ Tail Length .250, Standoff .250			21-033469-081
		PCB Quadrax Receptacle Straight Adapter/ Tail Length .110			21-033469-011
PCB Quadrax Receptacle Straight Adapter/ Tail Length .160			21-033469-091		
PCB Quadrax Receptacle Straight Adapter/ Tail Length .165			21-033469-151		
<p>Wired to board</p>	100	Quadrax Receptacle 90 degree Adapter with cable to board/ Thermax 1536-224			21-033469-021
		Quadrax Receptacle Straight Adapter with cable to board/ .195 tail length Thermax 1536-224			

Split-Pair Quadrax Contacts

Frequencies & Performance Data

FREQUENCIES OF INTEREST

For use with the following, but not limited to, electrical protocols:

- 10/100/1000/10GBASE-T Ethernet
- DVI
- USB 2.0
- Serial Rapid IO (up to 3.125 Gbps)
- PCI-Express 2.0
- HDMI 1.3a
- SATA 2.0 (up to 3 GHz)

Frequency (GHz)	Insertion Loss (dB)	Return Loss (dB)	NEXT (dB)	FEXT (dB)
0.1	0.09	35.68	62.36	59.29
0.24	0.22	36.44	42.87	62.25
0.5	0.45	43.66	43.63	55.22
0.625	0.57	43.49	53.68	43.53
1	0.98	17.82	49.26	48.33
1.25	1.29	15.1	43.57	44.12
1.5	1.47	17.94	46.02	40.78
1.7	1.86	12.23	48.01	47.23
2	2.11	12.9	37.45	38.12
2.5	2.42	15.97	29.9	31.52
3	2.86	16.52	35.94	29.36

PERFORMANCE DATA

The following graphs on this page and the next page provide performance data on Amphenol 10GBASE signal integrity (SI) quadrax contacts. Testing was done with 2 mated contacts terminated on both ends of 1 meter Thermax cable.

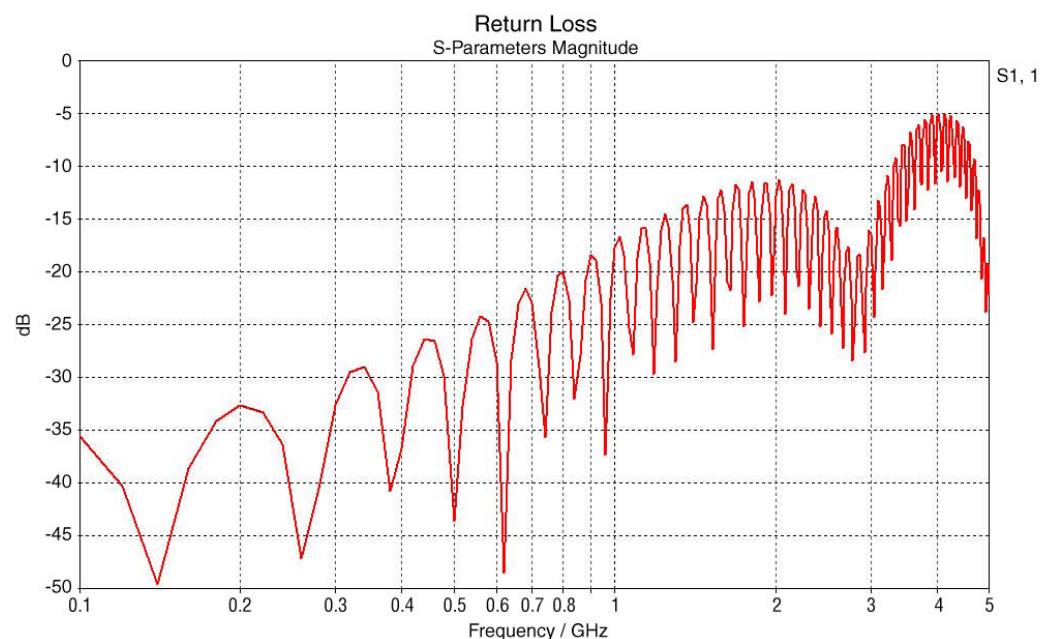
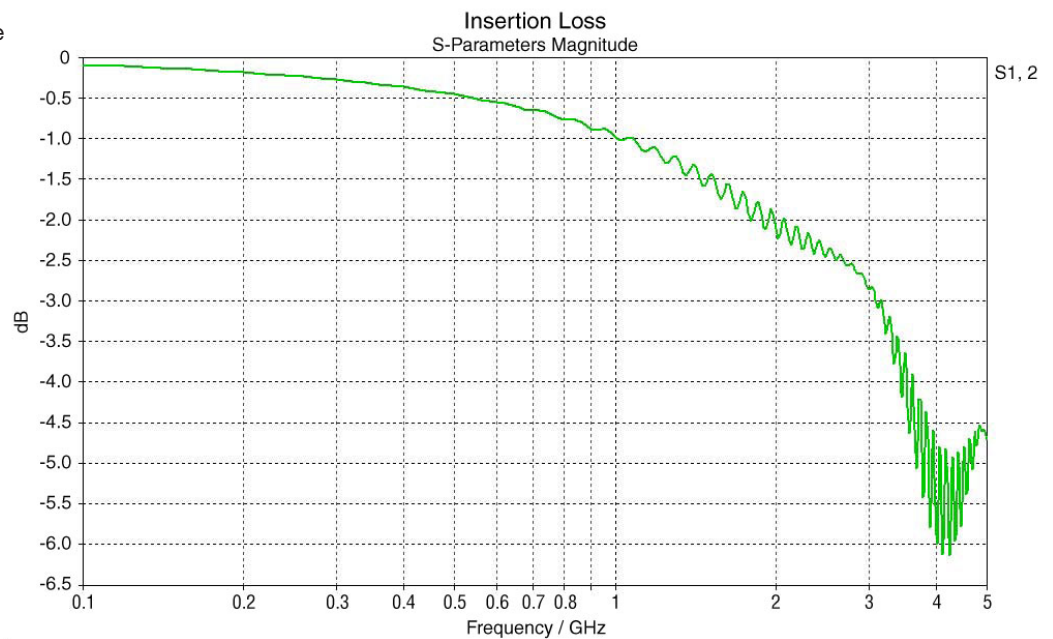

Split-Pair Quadrax Contacts

Frequencies & Performance Data

QUADRIX Split Pair

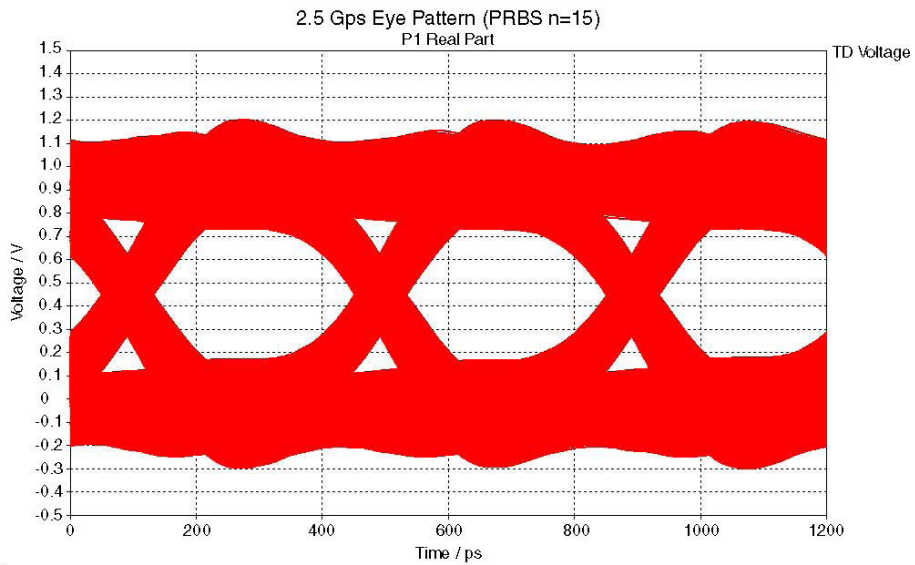
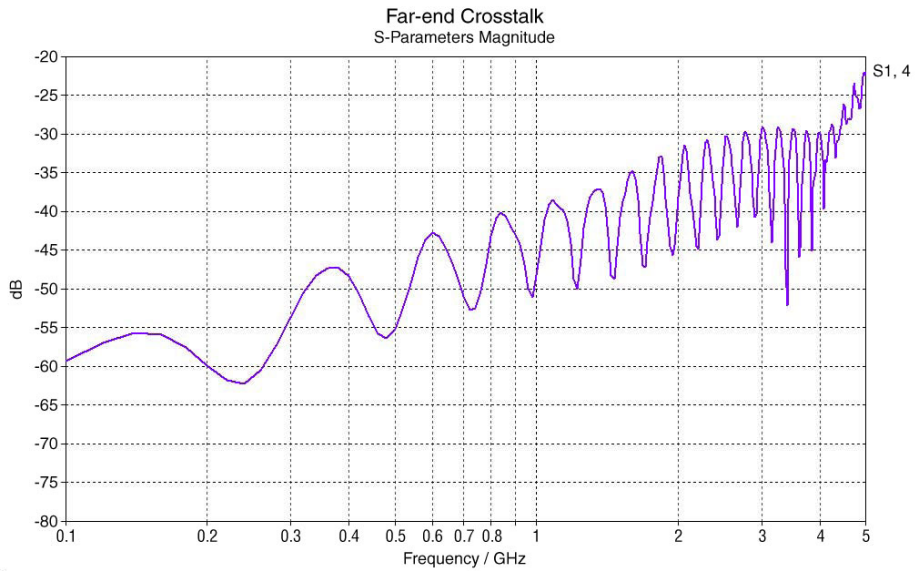
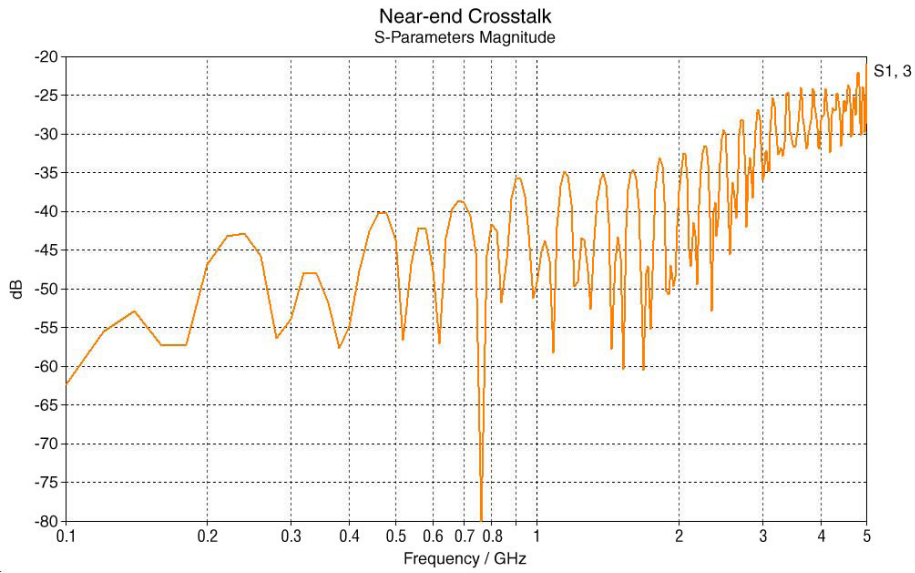

Differential Twinax Contacts

General Description

AMPHENOL DIFFERENTIAL TWINAX CONTACTS

Offer several advantages for high data transfer rates, low power consumption and excellent EMI compatibility:

- Two strategically spaced inner contacts form two 100 or 150 Ohm matched impedance differential pairs
- Outer contact has rugged wall section for durability
- Available in size 8 crimp termination style
- Also available in size 8 with PC tails
- Requires modification of MIL-DTL-38999 connector to accommodate keyed contacts

TYPICAL DIFFERENTIAL TWINAX SOCKET CONTACT

has socket outer contact with a socket inner contact

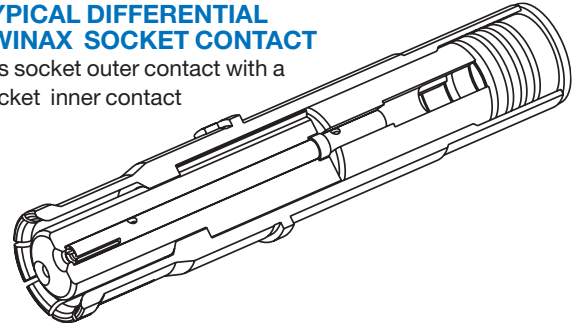

TYPICAL DIFFERENTIAL TWINAX PIN CONTACT

has pin outer contact with a pin inner contact

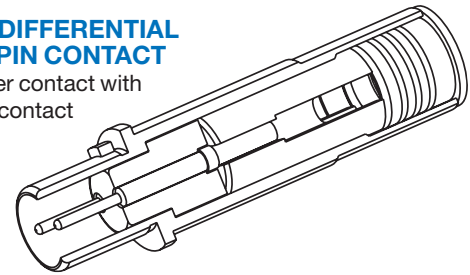

CABLE ILLUSTRATION DIFFERENTIAL TWINAX CONTACT

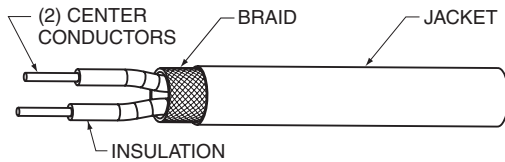

Differential Twinax Socket Contact

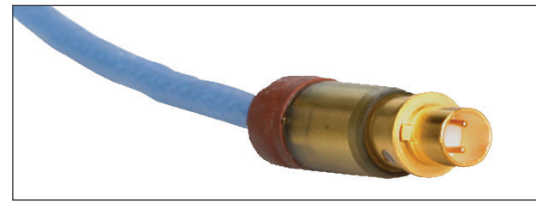

Differential Twinax Pin Contact

DIFFERENTIAL TWINAX CONTACTS ARE GOLD PLATED, CRIMP TERMINATION

Finish of mating contact parts: supplied with 0.000050 min. gold over nickel on mating interface.

DIFFERENTIAL TWINAX SIZE 8 CONTACT PERFORMANCE:

Bandwidth: Up to 1.25 GHz

Data Rate: Exceeding 2.5 Gbps

Voltage Rating: 500 Vrms max. @ sea level

Dielectric Withstanding

- Voltage:**
- 1000 VAC rms between all inner contacts @ sea level
 - 500 VAC rms between inner and outer contacts @ sea level

SUGGESTED NUMBERING OF DIFFERENTIAL TWINAX CONTACTS

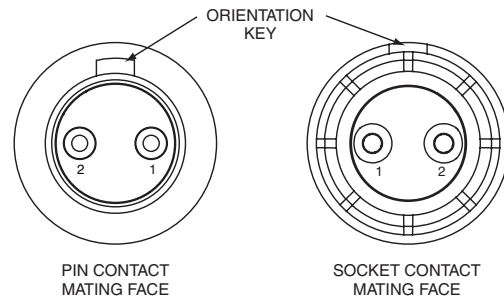

DIFFERENTIAL TWINAX CONTACT DATA

Contacts are inserted by hand. Refer to termination instructions listed. Contacts are removed with a removal tool. Recommended tool is MIL-I-81969/14-06, Daniels DRK-264-8. Refer to termination instructions listed. Finish of mating contact parts: Contact part numbers shown in the chart are supplied gold plated per ASTM B488 Type II, Code C, .000050 min. thick over nickel plate per AMS-QQ-N-290, Class 2, .000030/.000150 thick.

Differential Twinax Contacts

MIL-DTL-38999, Series III*, Contact Part Number Guide by Cable

DIFFERENTIAL TWINAX CONTACTS FOR USE IN TV-R CONNECTORS					
Impedance (Ohms)	Contact Size	Electrical Protocol††	Cable	Contact Part Number (Termination Instruction Sheet)**	
				Pin	Socket
100	8	Ethernet, USB	26463/70460X-2 (98 Ohm)	21-033387-021 (L-2119-E)	21-033388-021 (L-2119-E)
			Fileca 2709-3		
			GORE GSC-05-82559-00		
			Gore RCN9034		
			NF24T100-200C (Space)		
			PIC E10224		
			REV. B Raychem 0024A0024		
			S280W502-1		
			ST5M1284-003 (98 Ohm)		
			Tensolite 24463/05099X-8(LD)		
			Tensolite 24463/9P025X-2(LD)		
			Tensolite NF24T100		
			Thermax 12814		
			Thermax MX 100-24		
			BMS13-72T07C02G024		
			GORE GSC-05-827300-00	21-033387-051*** (L-2119-AY)	21-033388-051*** (L-2119-AY)
			Tensolite 26453/03184X-2(LD)		
			Thermax 956-626Z	21-033387-041 (L-2119-T)	21-033388-041 (L-2119-T)
			ASNE08072003-09, -041		
			Cheminax 7726SOLL 4		
			DXN 2310		
			GORE GSC-05-81973-00		
			GORE GSC-05-827300-00		
			Tensolite 26453/03184X-2(LD)		
			Thermax 956-626Z		
			23460/05114X-2(LD)		
			PIC E1024		
			M17/176-00002 (77 Ohm)	21-033387-071 (L-2119-BJ)	21-033388-071 (L-2119-BJ)
			Raychem 0026A0024		
			CAN24TST120	21-033387-091 (L-2119-BT)	21-033388-091 (L-2119-BT)
			JSFY11-24		
			Tensolite 24463/03220T-2(LD)		
Thermax 956-1T200					
S280W502-6	21-033387-101 (L-2119-AK)	21-033388-101 (L-2119-AK)			
Tensolite 24463/9P026X-2(LD)					
AXON P509782	21-033387-131	21-033388-131			
CAN24TDT120	21-033387-141	21-033388-141			
GC875ACH	21-033387-151	21-033388-151			
Tensolite 26453/03184X-2(LD)	21-033387-161	21-033388-161			
Gore DXN 2125	21-033387-031 (L-2119-AC)	21-033388-031 (L-2119-AC)			
Tensolite 26483/03071X-2(LD)	21-033456-001 (L-2119-BX)†	21-033457-001 (L-2119-BX)†			
150	Fibre Channel, 1000 Base-CX Ethernet	Tensolite 26483/03071X-2(LD)	21-033456-001 (L-2119-BX)†	21-033457-001 (L-2119-BX)†	

Daniels crimping tools are available from Daniels Mfg. Corp. 6103 Anno Ave., Orlando, FL 32809

* Requires modified connector to accommodate keyed contacts.

*** Indicated contact is vacuum degassed

†† Test reports available for indicated protocols. Consult Amphenol Aerospace.

** Termination instructions are packaged with each contact and can be found on-line at: www.amphenol-aerospace.com/serviceinstructions.asp

† Consult Amphenol Aerospace for current release of this instruction sheet.

Differential Twinax Contacts

MIL-DTL-38999, Series III*, Contact Part Number Guide by Cable

PCB DIFFERENTIAL TWINAX CONTACTS FOR USE IN TV-R CONNECTORS

Impedance (Ohms)	Contact Size	PCB Twinax Contacts Length	Contact Part Number	
			Pin	Socket
100	8	.494	21-033834-041	21-033835-041
		.530	21-033834-131	21-033835-131
		.780	21-033834-061	21-033835-061
		.788	21-033834-031	21-033835-031
		.806	21-033834-111	21-033835-111
		.819	21-033834-141	21-033835-141
		.843	21-033834-101	21-033835-101
		.871	21-033834-071	21-033835-071
		.908	21-033834-121	21-033835-121
		.937	21-033834-081	21-033835-081
		.939	21-033834-051	21-033835-051
		1.035	21-033834-001	21-033835-001
		1.035	21-033834-091	21-033835-091
		1.035	21-033834-021	21-033835-021
		150		1.035 mates to 21-33456/57 series

Daniels crimping tools are available from Daniels Mfg. Corp. 6103 Anno Ave., Orlando, FL 32809

Indicated length given in chart at left is the distance from the rear of the contact retention shoulder to the tip of the PCB tails.

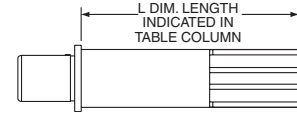

Note: It does not indicate stickout length when installed in D38999 connector.

Differential Twinax Transition Adapters

MIL-DTL-38999, Series III, Attachment to PC Boards Data

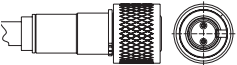
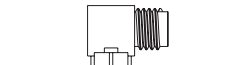
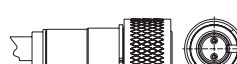
100 OHM DIFFERENTIAL TWINAX TRANSITION ADAPTERS FOR LAUNCHING CONTROLLED IMPEDANCE SIGNALS TO PC BOARDS					
Illustration of Adapter	Impedance (Ohms)	Differential Twinax Type Adapter/ Cable or PCB Tail Length	Mating Thread Size	Part Number (Termination Instruction Sheet)**	
				Plug	Receptacle
	77	M17/176-00002 (77 ohms)	.3125	21-033832-081 (L-2119-AJ)	
		Tensolite 24463/9P026X-2		21-033832-081 (L-2119-AJ)	
		Tensolite 24463/9P025X-2(LD) 10-646060		21-033832-021 (L-2119-P)	
		Tensolite 24463-9P025X-2(LD) hex nut w/lockwire holes		21-033832-181	
		PCB Differential Twinax Receptacle 90 Degree Adapter/ Tail Length .110			21-033833-021
		PCB Differential Twinax Receptacle Straight Adapter/ Tail Length .110			21-033833-031
	100	PCB Differential Twinax Receptacle Straight Adapter/ Tail Length .165			21-033833-151
		Tensolite CAN22TDT120 (120 Ohm)	.375	21-033832-111†	
		PCB Differential Twinax Receptacle 90 degree Adapter/Tail Length .283			21-033833-161†
PCB Differential Twinax Receptacle Straight Adapter/Tail Length .283		21-033833-171†			
	100	Differential Twinax Receptacle 90 degree Adapter (low profile) with cable to board/ Tensolite 24463/9P026X-2	N/A		21-033833-091 (L-2119-AF)
		Differential Twinax Receptacle 90 degree Adapter with cable to board/ Tensolite 24463/9P025X-2			21-033833-051 (L-2119-V)
		Differential Twinax Receptacle 90 degree Adapter with cable to board/ Tensolite 24463/9P025X-2			21-033833-141 (L-2119-BU)

† Consult Amphenol Aerospace for current release of this adapter and instruction sheet if applicable. See electrical protocols for transition adapters on page 36.

** Termination instructions are packaged with each contact and can be found on-line at: www.amphenol-aerospace.com/serviceinstructions.asp

Differential Twinax Transition Adapters

MIL-DTL-38999, Series III, Attachment to PC Boards Data

150 OHM DIFFERENTIAL TWINAX TRANSITION ADAPTERS FOR LAUNCHING CONTROLLED IMPEDANCE SIGNALS TO PC BOARDS						
Illustration of Adapter	Impedance (Ohms)	Differential Twinax Type Adapter/Cable or PCB Tail Length	Mating Thread Size	Part Number (Termination Instruction Sheet)**		
				Plug	Receptacle	
	150	Differential Twinax Plug Adapter/ Tensolite 26483\03071X-2	.375	21-033832-091 (L-2119-BR)		
		Tensolite 26483\03071X-2		21-033832-271		
		PCB Differential Twinax Receptacle 90 Degree Adapter/ Tail Length .110			21-033833-111	
		PCB Differential Twinax Receptacle, Space grade, 90 Degree Adapter/ Tail Length .110			21-033833-351	
		PCB Differential Twinax Receptacle Straight Adapter/ Tail Length .110			21-033833-181†	
	150	Differential Twinax Receptacle 90 degree Adapter with cable to board/ Tensolite 26483\03071X-2	N/A		21-033833-101 (L-2119-BM)†	

† Consult Amphenol Aerospace for current release of this adapter and instruction sheet, if applicable.

** Termination instructions are packaged with each contact and can be found on-line at: www.amphenol-aerospace.com/serviceinstructions.asp

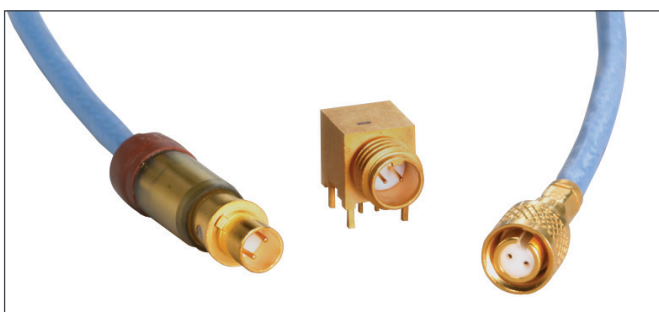

90° Differential Twinax Receptacle and Plug Transition Adapter

TRANSITION ADAPTER DATA

Finish of mating contact parts: Contacts are supplied gold plated per ASTM B488 Type II, Code C, .000050 min. thick over nickel plate per AMS-QQ-N-290, Class 2, .000030/.000150 thick.

ELECTRICAL PROTOCOLS FOR DIFFERENTIAL TWINAX TRANSITION ADAPTERS			
Impedance (Ohms)	Electrical Protocol††	Part Number	
		Plug	Receptacle
100		21-033832-81	
	Ethernet	21-033832-21	
		21-033832-111†	
			21-033833-021 (90°)
	Ethernet		21-033833-031 (90°)
			21-033833-151 (90°)
			21-033833-161† (90°)
			21-033833-171† (90°)
			21-033833-091 (90°)
			21-033833-051 (90°)
150		21-033832-91	
			21-033833-111 (90°)
			21-033833-181† (90°)
			21-033833-101 (90°)

† Consult Amphenol Aerospace for current release of this adapter.

†† Test reports available for indicated protocols; consult Amphenol Aerospace.

Micro Differential Twinax Transition Adapters

Push-Pull Quick-Disconnect Interconnects

MICRO DIFFERENTIAL TWINAX TRANSITION ADAPTERS

Amphenol now offers differential twinax transition adapters in smaller sizes that provide matched impedance interconnection to PCB boards. Our unique push-pull quick disconnect adapter design offers:

- Advantages over traditional threaded type adapters
- Launching of controlled impedance (100 ohm) signals for high speed twinax contacts with push-pull quick disconnect coupling
- Rugged construction, 100+ mating cycles for reliable and secure data transmission
- Miniature size for tighter spacing on boards
- Intermountability with existing threaded solutions having the same PCB tail footprint

STYLES INCLUDE:

- Plug - standard length and extended length options
- Straight PCB receptacle, 90° PCB receptacle
- Two jam nut receptacle styles - both with standard length and extended length options
- Bushing assembly 90° adapter (used with plug or jam nut receptacle)

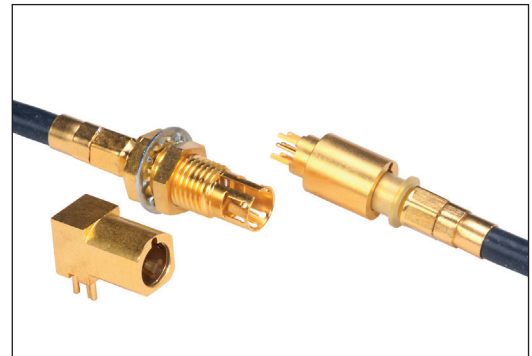

Micro Differential Twinax Transition Adapters
Shown right: Straight receptacle mated to plug
Shown left: Jam nut and 90° receptacles

MICRO DIFFERENTIAL TWINAX TRANSITION ADAPTER PLUG

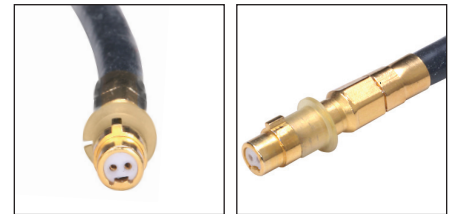
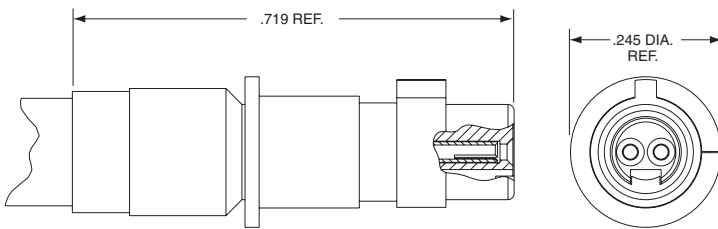

Impedance (Ohms)	Cable Type*	Part Number
100	Calmont 3007-1923-12-7	21-033832-151
	Calmont 3007-1923-12-7	21-033832-121**
	Tensolite 26453/03184X-2LD	
	Thermax 956-626Z	21-033832-161
	Thermax 956-626S	

* See page 39 for information on other cable terminations.

** Same as -151 with extended ferrule for added cable support

MICRO DIFFERENTIAL TWINAX TRANSITION ADAPTER STRAIGHT PCB RECEPTACLE

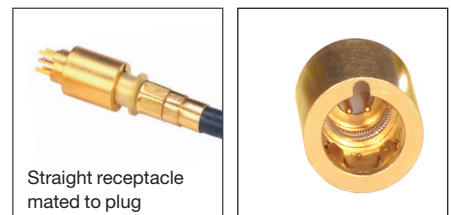
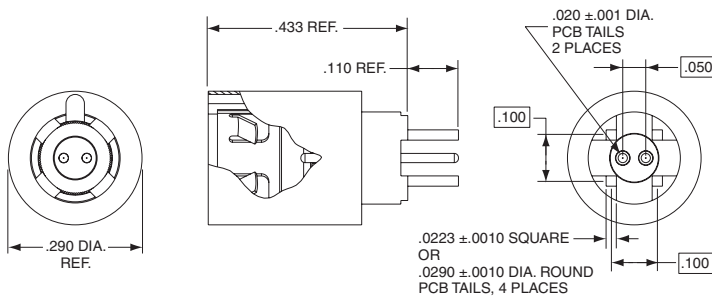

Straight receptacle mated to plug

Impedance (Ohms)	Part Number
100	21-033833-191

All dimensions for reference only.

Micro Differential Twinax Transition Adapters

Push-Pull Quick Disconnect Interconnects

MICRO DIFFERENTIAL TWINAX TRANSITION ADAPTER 90° PCB RECEPTACLE

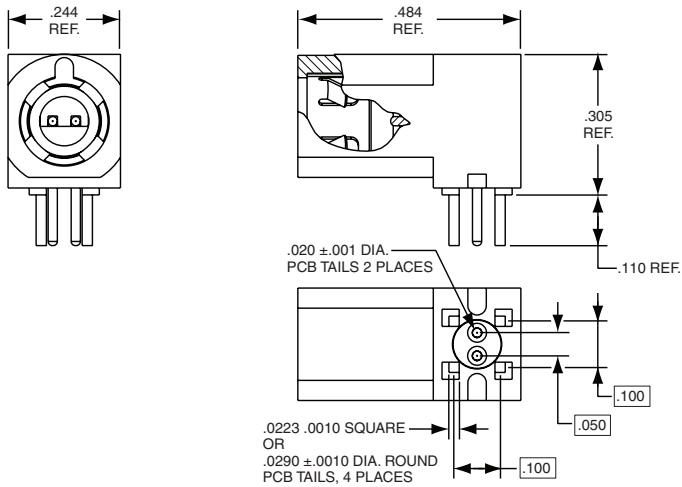

90 Degree receptacle mated to plug

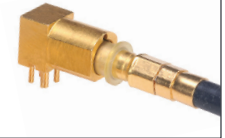

Impedance (Ohms)	Part Number
100	21-033833-201
	21-033833-281
	.140 PCB tail length

MICRO DIFFERENTIAL TWINAX TRANSITION ADAPTER JAM NUT RECEPTACLES

JAM NUT RECEPTACLE, STYLE 1

Smaller diameter front shell requires a smaller mounting D-hole dimension in panel.

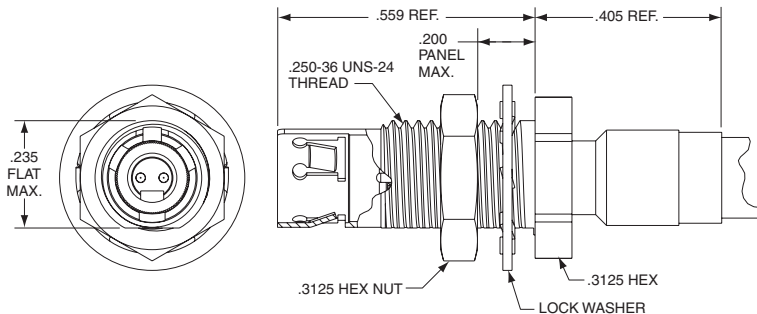

Jam nut receptacle, Style 1, mated to plug



Impedance (Ohms)	Cable Type*	Part Number
100	Calmont 3007-1923-12-7	21-033833-211**
	Calmont 3007-1923-12-7	21-033833-241
	Tensolite 26453/03184X-2LD	21-033833-261
	Thermax 956-626Z	

* See page 39 for information on other cable terminations.

** Same as -241 with extended ferrule for added cable support

JAM NUT RECEPTACLE, STYLE 2

Has a larger diameter front shell than Style 1. Requires a larger mounting D-hole in panel.

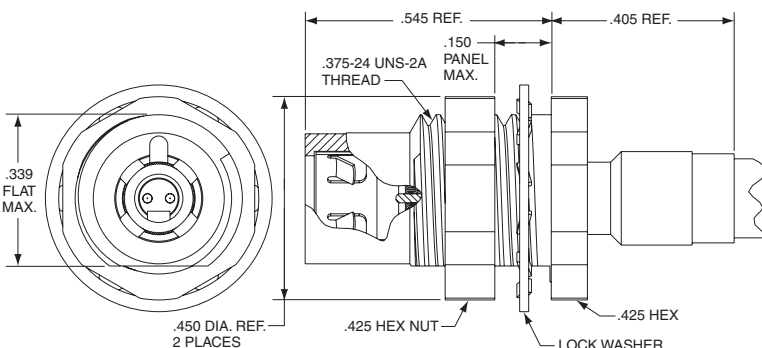

Jam nut receptacle, Style 2, mated to plug



Impedance (Ohms)	Cable Type*	Part Number
100	Calmont 3007-1923-12-7	21-033833-231**
	Calmont 3007-1923-12-7	21-033833-251
	Tensolite 26453/03184X-2LD	21-033833-271
	Thermax 956-626Z	

* See page 39 for information on other cable terminations.

** Same as -251 with extended ferrule for added cable support

All dimensions for reference only.

Micro Differential Twinax Transition Adapters

Push-Pull Quick Disconnect Interconnects

90° BUSHING ASSEMBLIES FOR USE WITH WIRED MICRO DIFFERENTIAL TWINAX TRANSITION ADAPTERS

Amphenol provides bushing assemblies which convert straight plug and receptacle wired adapters into 90° wired adapters. To facilitate tight cable bend requirements.

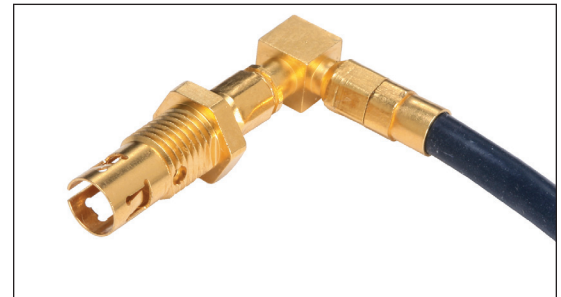
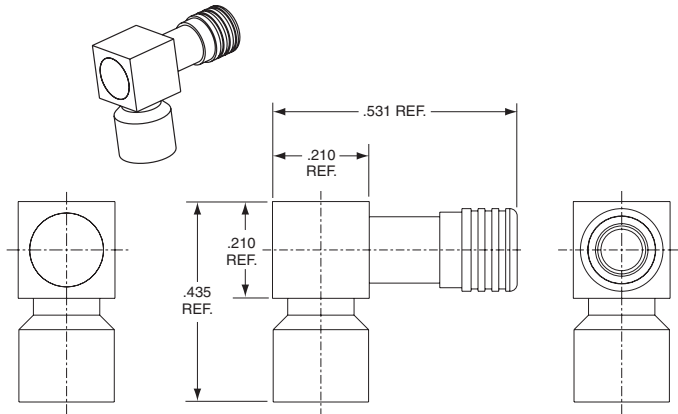

90° Bushing Assembly with Jam Nut Micro Differential Transition Adapter

90° Bushing Assembly
Part Number

21-033425-201

90° bushing assembly is ordered separately. Adapters are not included with bushing assembly.

Illustrations below show how the 90° bushing assembly attaches to either a plug or a jam nut receptacle adapter.

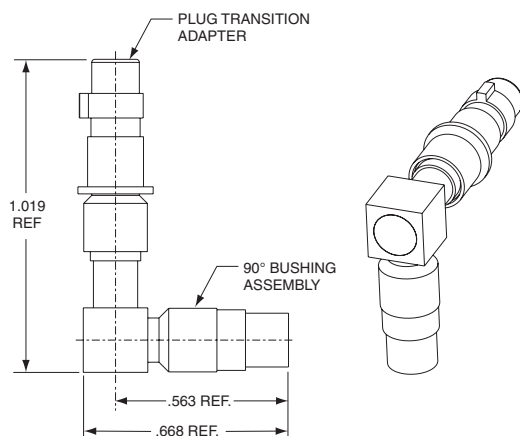

90° BUSHING ASSEMBLY WITH WIRED MICRO DIFFERENTIAL PLUG TRANSITION ADAPTER

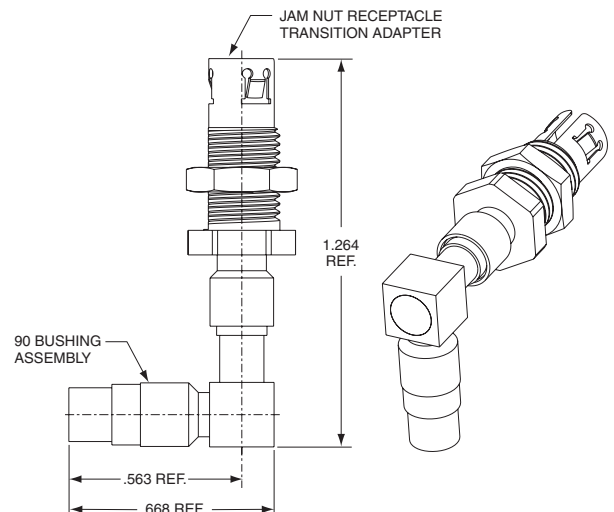

90° BUSHING ASSEMBLY WITH WIRED MICRO DIFFERENTIAL JAM NUT RECEPTACLE TRANSITION ADAPTER

Amphenol transition adapters are capable of terminating to additional 100 Ohm cables beyond what are listed in the charts on pages 37 and 38.

Cables need to have the following dimensions:

- .0210/.011 Dia. stranded center conductor (26/30 AWG)
- .045 Dia. max. inner wire insulation
- .115 Dia. max. outer braid (round type preferred)
- .150 Dia. max. jacket
- Consult Amphenol Aerospace for other cable termination possibilities.

All dimensions for reference only.

Quadrax Rectangular Connectors

General Description

AMPHENOL QUADRAX CONTACTS FOR RECTANGULAR BOARD LEVEL CONNECTORS

Incorporate the same size 8 Quadrax PCB contacts as used in circular 38999 connectors.

Size 8 Quadrax Compliant contacts with hole diameters:

- .025 ±.002 PTH Quadrax contact
- .040 ±.003 PTH shell grounding
- Accommodates backplane .125 inch min. thickness

Consult Amphenol Aerospace for availability of additional connector configurations

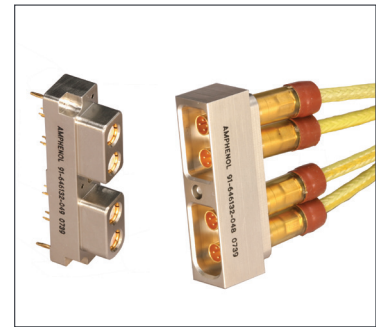

*Compliant Pin Quadrax
Board Level Connector*

4 POSITION BOARD LEVEL CONNECTOR WITH QUADRAX

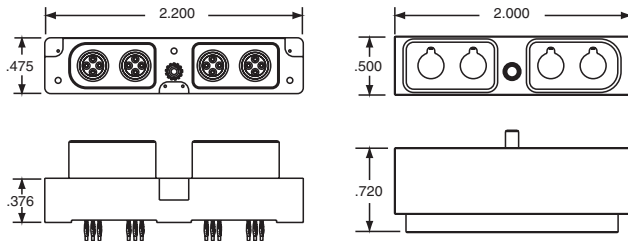

8 POSITION BOARD LEVEL CONNECTOR WITH QUADRAX

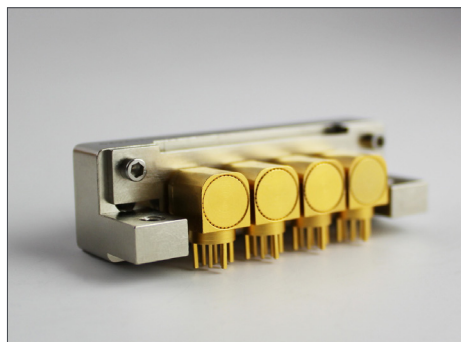
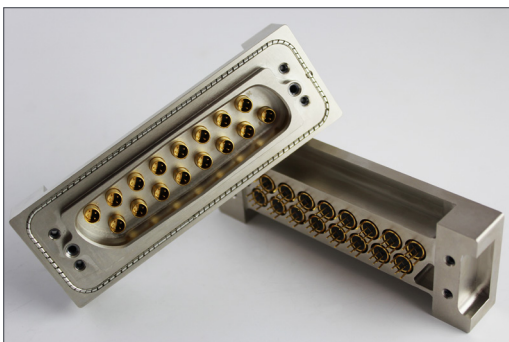
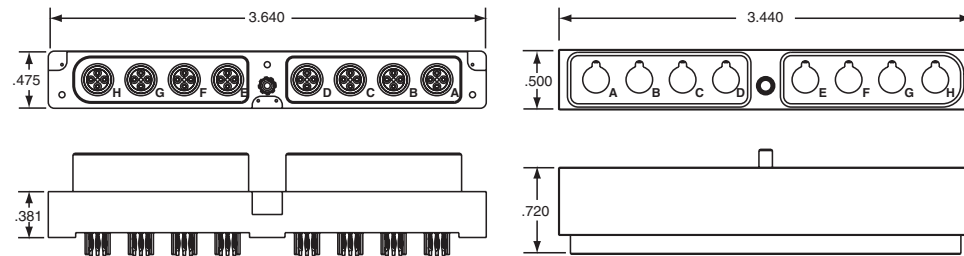

High Speed Contacts for Rack & Panel

ARINC 600 & R27 Rack and Panel Connectors

QUADRAX CONTACTS FOR USE IN ARINC 600 & R27 CONNECTORS

Impedance (Ohms)	Contact Size	Cable	Contact Part Number (Termination Instruction Sheet)**	
			Pin	Socket
100	8	24443/03130X-4(LD)	21-033382-021 (L-2119-AH)	21-033383-021 (L-2119-AH)
		24443/9P025X-4(LD)		
		PIC E51424		
		S280W502-4		
		Tensolite NF24Q100-01	21-033382-031 (L-2119-I)	21-033383-031 (L-2119-I)
		Draka Fileca F-4703-3		
		Draka Fileca F-4704-5		
		NF22Q100	21-033382-101 (L-2119-AS)†	21-033383-101 (L-2119-AS)†
110		JSFY02-1	21-033382-071†	21-033383-071†
150		Gore RCN8328	21-033382-061 (L-2119-L)	21-033383-061 (L-2119-L)
		Tensolite 26473/02006X-4(LD)		

DIFFERENTIAL TWINAX CONTACTS FOR USE IN ARINC 600 & R27 CONNECTORS

Impedance (Ohms)	Contact Size	Cable	Contact Part Number (Termination Instruction Sheet)**	
			Pin	Socket
77		GC875TM24H	21-033378-061 (L-2119-AU)	21-033379-061 (L-2119-AU)
100	8	ABS0386WF24	21-033378-021 (L-2119-G)	21-033379-021 (L-2119-G)
		ASNE0272TK22	21-033378-031 (L-2119-G)	21-033379-031 (L-2119-G)
		ASNE0272TK24	21-033378-041 (L-2119-G)	21-033379-041 (L-2119-G)
		Tensolite 24463/9P025X-2(LD)	21-033378-051†	21-033379-051†
110			21-033378-071†	21-033379-071†

COAX CONTACTS FOR USE IN ARINC 600 & R27 CONNECTORS

Contact Size	Cable	Contact Part Number (Termination Instruction Sheet)**	
		Pin	Socket
8	RG-179	21-033676-001 (L-2090-B)	21-033675-001 (L-2090-A)
	RG316		
	RG-179	21-033476-001	21-033475-001
	RG316		
	5M2869-001	21-033676-002†	21-033675-002†

TWINAX CONTACTS FOR USE IN ARINC 600 & R27 CONNECTORS

Contact Size	Cable	Contact Part Number (Termination Instruction Sheet)**	
		Pin	Socket
12	10612	21-033631-004† (L-2092-U)†	21-033632-003 (L-2092-J)
	EPD 32263		
	GSC-12-2548-00		

PCB QUADRAX CONTACTS FOR USE IN ARINC 600 & R27 CONNECTORS

Impedance (Ohms)	Contact Size	PCB Quadrax Contacts	Contact Part Number	
			Pin	Socket
100	8	PCB (.346 Length)		21-033397-171
		PCB (.473 Length)	21-033398-261	

† Consult Amphenol Aerospace for current release of this contact or instruction sheet if applicable. Daniels crimping tools are available from Daniels Mfg. Corp. 6103 Anno Ave., Orlando, FL 32809

**Termination instructions are packaged with each contact and can be found on-line at: www.amphenol-aerospace.com/serviceinstructions.asp

RECTANGULAR

Insert Arrangements-MIL-DTL-38999

Incorporating Coax, Twinax and Triax Contacts

Front face of pin inserts illustrated

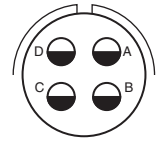
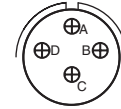
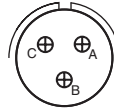

Insert Arrangement	9-5	10-2	11-2	12-3	13-3	12-4	13-4	14-4	15-4
Connector Series	TV	SJT	LJT, TV	JT	LJT	JT, SJT	LJT, TV	JT	LJT
Service Rating	Grounded	I		II		I		I	
Number of Contact	1	2		3		4		4	
Contact Size	8 Twinax	16		16		16		16	12

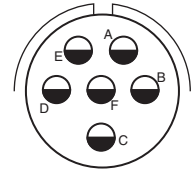
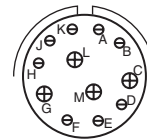
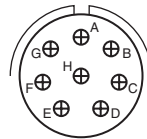
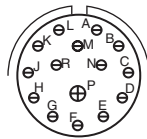
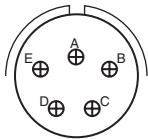

Insert Arrangement	14-5	15-5	14-15	15-15	14-68	15-68	14-97	15-97	16-6	17-6
Connector Series	JT, SJT	LJT, TV	JT, SJT	LJT, TV	JT	LJT	JT, SJT	LJT, TV	JT, SJT	LJT, TV
Service Rating	II		I		I		I		I	
Number of Contact	5		14	1	8		8	4		6
Contact Size	16		20	16	16		20	16		12

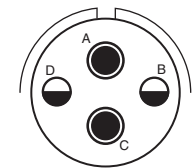
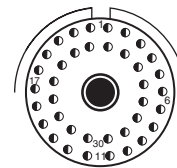
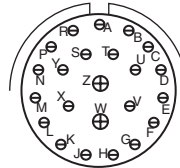
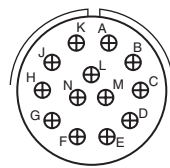
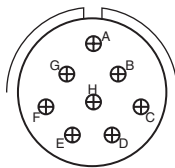

Insert Arrangement	16-8	17-8	16-13	17-13	16-99	17-99	17-2	17-22
Connector Series	JT, SJT	LJT, TV	JT, SJT	LJT	JT, SJT	LJT, TV	LJT	TV
Service Rating	II		I		I		M	Coax
Number of Contact	8		13		21	2	38	1
Contact Size	16		16		20	16	22D	8

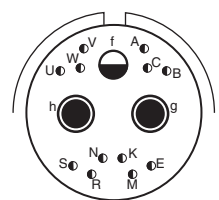
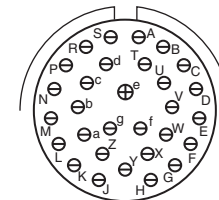
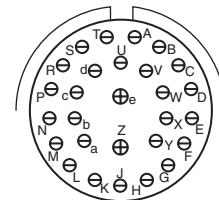
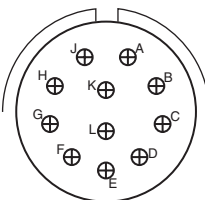
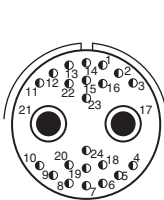

Insert Arrangement	17-25	18-11	19-11	18-28	19-28	18-30	19-30	19-31
Connector Series	LJT	JT, SJT	LJT, TV	JT	LJT	JT	LJT	TV
Service Rating	M		II		I		I	M
Number of Contact	22	2	11	26	2	29	1	2
Contact Size	22D	8	16	20	16	20	16	8

The insert arrangements shown on this page and the next page represent the most readily available patterns within the 38999 Circular Series. Contact Amphenol if you require other arrangements than what are shown here. Size 8 and size 12 cavities can be filled with either coax, twinax, triax or power contacts in most cases.

CONTACT LEGEND

8	10	12	16	20	22D
Coax, Twinax Triax or Power	Twinax, Triax, or Power	Coax, Twinax, Triax or Power	Coax or Power	Power	Power

Insert Patterns-MIL-DTL-38999

Incorporating Coax, Twinax and Triax Contacts

Front face of pin inserts illustrated

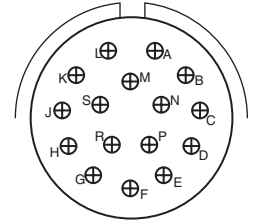
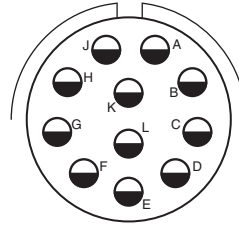
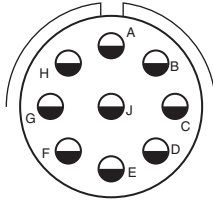
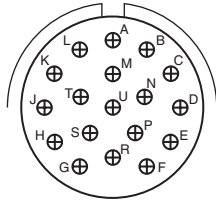

Insert Arrangement	18-68	19-68	18-96	20-11	21-11	20-16	21-16
Connector Series	JT	LJT	JT	JT, SJT	LJT, TV	JT, SJT	LJT, TV
Service Rating	I		I	I		II	
Number of Contact	18		9	11		16	
Contact Size	16		12	12		16	

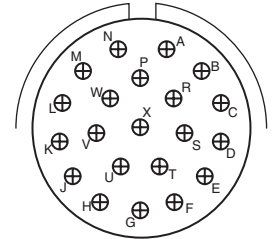
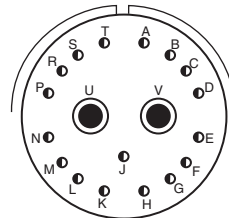
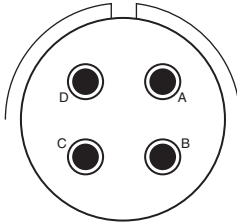
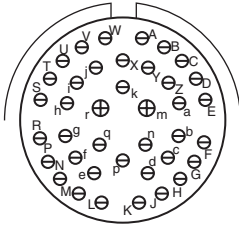

Insert Arrangement	20-39	21-39	20-75	21-75	20-79	21-79	22-21	23-21
Connector Series	JT, SJT	LJT, TV	SJT	LJT, TV	SJT	LJT	JT, SJT	LJT, TV
Service Rating	I		M		II		II	
Number of Contact	37	2	4		17		21	
Contact Size	20	16	8		22D		16	

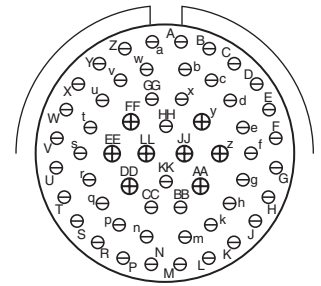
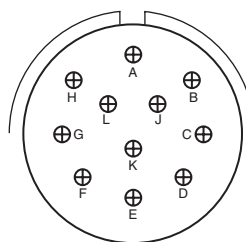
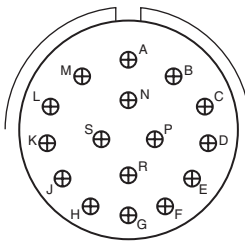
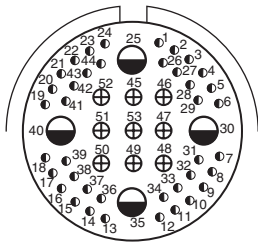

Insert Arrangement	23-54		23-97	23-99	24-4	25-4	
Connector Series	TV		LJT	LJT	JT, SJT	LJT, TV	
Service Rating	M		II	II	I		
Number of Contact	40	9	4	16	11	48	8
Contact Size	22D	16	12	16	16	20	16

CONTACT LEGEND



8
Coax, Twinax
Triax or Power



10
Twinax, Triax,
or Power



12
Coax, Twinax,
Triax or Power



16
Coax or
Power



20
Power



22D
Power

Insert Patterns-MIL-DTL-38999

Incorporating Coax, Twinax and Triax Contacts

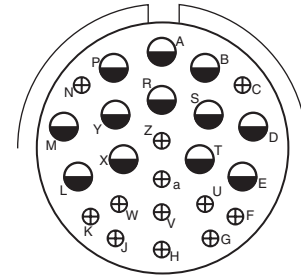
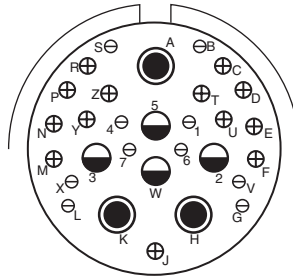
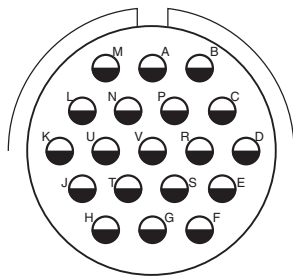

Insert Arrangement	24-19	25-19	24-20		25-20*		24-24	25-24
Connector Series	JT, SJT	LJT, TV	SJT		LJT, TV		JT, SJT	LJT, TV
Service Rating	I		N					
Number of Contact	19		10	13	3	4	12	12
Contact Size	12		20	16	8	12	16	12
(Locations U and Y - Dedicated to Fiber Optics)								

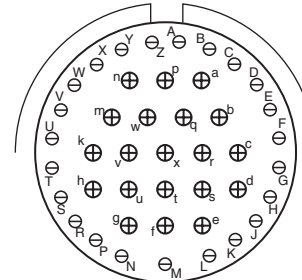
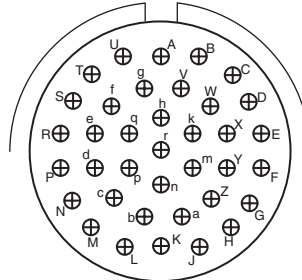
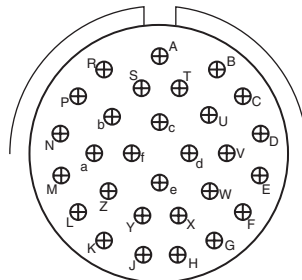

Insert Arrangement	24-29	25-29	24-37		25-37		24-43	25-43		
Connector Series	JT, SJT	LJT, TV	JT, SJT		LJT, TV		JT, SJT	LJT, TV		
Service Rating	I		I							
Number of Contact	29		37						23	20
Contact Size	16		16						20	16

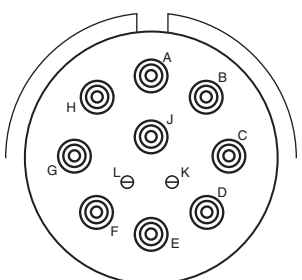
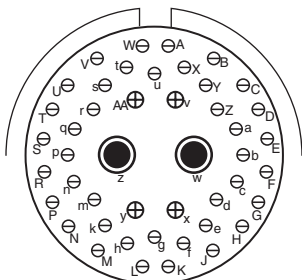

Insert Arrangement	24-46	25-46	25-11*	
Connector Series	SJT	LJT, TV	LJT, TV	
Service Rating	I			
Number of Contact	40	4	2	9
Contact Size	20	16	8	10

* For use in MIL-STD-1760 applications with MIL-DTL-38999 Series III.

CONTACT LEGEND



Coaxial Contacts

General Description

AMPHENOL COAXIAL CONTACTS

Offer several advantages for reliable interconnection and continued performance:

- Large crimping area assures low contact resistance and high tensile strength
- Back insulator positively captivates inner contact against axial loads
- Front insulator provides closed entry for socket inner contact
- Recessed inner contact is protected
- Outer contact has rugged wall section for durability



MIL-DTL-38999 LJT-R, JT-R, TV-R, SJT-R MS Type, Coax Size 12 Socket Assembled Contact

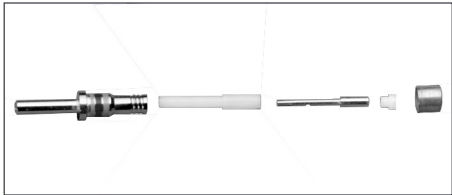

MIL-DTL-38999 LJT-R, JT-R, TV-R, SJT-R MS Type, Coax Size 16 Pin Unassembled Contact



MIL-DTL-38999 LJT-R, JT-R, TV-R, SJT-R MS Type, Coax Size 8 Pin Assembled Contact

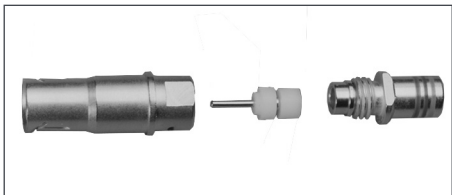

MIL-DTL-38999 LJT-R, JT-R, TV-R, SJT-R MS Type, Coax Size 8 Socket Unassembled Contact

TYPICAL SUBMINIATURE COAX SOCKET CONTACT

has socket outer contact with a pin inner contact

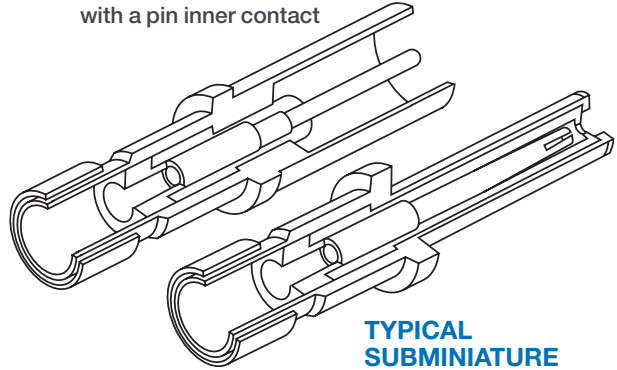

TYPICAL SUBMINIATURE COAX PIN CONTACT

has pin outer contact with a socket inner contact

CABLE ILLUSTRATION - COAX CONTACT

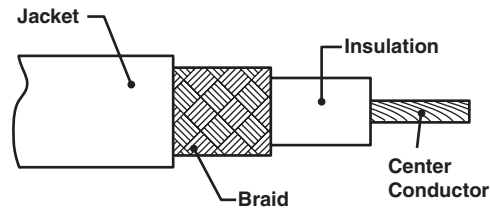

COAX CONTACTS ARE GOLD PLATED, CRIMP TERMINATION

Finish of mating contact parts: supplied with 0.000050 min. gold over nickel on mating parts. Other finishes are available; consult Amphenol for further information.

COAX SIZE 12 & 16 CONTACT PERFORMANCE:

Typical VSWR:

- 1.5:1 maximum up to 700 MHz and 500 MHz respectively, for properly cabled size 12 and 16 coaxial contacts in the M38999 Series I, II and III

Insulation Resistance:

- 5,000 megohms minimum @ 25°C

Dielectric Withstanding Voltage:

- Size 12: 1,000 VAC Rms @ sea level, 250 VAC Rms @ 50,000 ft.
- Size 16: 800 VAC Rms @ sea level, 250 VAC Rms @ 50,000 ft.

Contact Resistance:

- See MIL-C-39029/27, /28, /75, /76, /77, /78

COAX SIZE 8 CONTACT PERFORMANCE:

Typical VSWR when terminated to specified 50 ohm cable:

- 1.5:1 maximum up to 3 GHz (excluding 21-033101/2-27)
- Insulation Resistance: 5,000 megohms minimum @ 25°C

Dielectric Withstanding Voltage:

- 1,300 VAC Rms @ sea level, 250 VAC Rms @ 50,000 ft.

Contact Resistance:

- See MIL-C-39029/59, /60

Coaxial Contacts

Contact Part Number Guide by Cable

JT-R Series, MIL-DTL-38999 Series II, SAE AS39029 (27, 28, 76, 78)

COAX CONTACTS FOR USE IN JT-R CONNECTORS					
Contact Size	Cable	Installation Tools		Contact Part Number (Termination Instruction Sheet)**	
		Insertion	Removal	Pin	Socket
16	RG-178B/U	M81969/8-07 or M81969/ 14-03 or Amphenol 11-8674-16 11-8794-16 or MS27495A16 or MS27534-16	M81969/8-08 or M81969/14-03 or Amphenol 11-8675-16 11-8795-16 or MS27495R16 or MS27534-16	21-033122-564 (M39029/76-425) (L-2035-AG)	21-033121-564 (M39029/78-433) (L-2035-AH)
	RG-196A/U			21-033122-562† (L-2035-AN)	21-033121-562† (L-2035-AP)
	26723/A955KK1				
	30-02024				
	30-02033				
	Haveg 30-00761				
	Tensolite 24713/A955KK1				
	Haveg 61-02051	21-033122-561† (L-2035-AK)	21-033121-561† (L-2035-AL)		
	AA3248			21-033122-563 (M39029/76-424) (L-2035-AD)	21-033121-563 (M39029/78-432) (L-2035-AE)
	Haveg 8100207				
	Raychem 7528H1424				
	RG-161/U				
	RG-174A/U				
	RG-179B/U				
RG-187A/U					
RG-188A/U					
RG-316/U					
Teledyne 11299					
12	Times (HS-179)	M81969/8-09 or M81969/ 14-04 or Amphenol 11-8674-12 11-8794-12 or MS27495A12 or MS27534-12	M81969/8-10 or M81969/14-04 or Amphenol 11-8675-12 11-8795-12 or MS27495R12 or MS27534-12	21-033122-546 (M39029/28-211) (L-2035-F)	21-033121-546 (M39029/27-210) (L-2035-G)
	Haveg 8100207				
	Raychem 7528H1424				
	RG-161/U				
	RG-174A/U				
	RG-179B/U				
	RG-187A/U				
	RG-188A/U				
	RG-316/U				
	Teledyne 11299				
	Times (HS-179)	21-033122-541 (M39029/28-409) (L-2035-C)	21-033121-541 (M39029/27-402) (L-2035-E)		
	Raychem 9528A1318				
	RG-180B/U,				
	RG-195A/U				
	Raychem 5022E5111			21-033122-543† (L-2035-M)	21-033121-543† (L-2035-N)
	Raychem 9530A5314			21-033122-544 (L-2035-R)	21-033121-544 (L-2035-S)
Raychem 9527A1318	21-033122-545 (L-2035-U)			21-033121-545 (L-2035-V)	
Filotex 124962	21-033122-547† (L-2035-X)	21-033121-547† (L-2035-Y)			
Gore GWN1159A					

MIL-DTL-38999 CONTACT DATA

All contacts mate with other contacts in this series which have the same inner and outer contact diameters.

Finish of mating contact parts: Contact part numbers shown in the chart above are supplied with 0.000050 min. gold (Knoop hardness 130-200) over nickel on mating parts. Other finishes are available; consult Amphenol.

NOTE: SAE AS39029 supersedes MIL-C-39029

** Termination instructions are packaged with each contact and can be found on-line at: www.amphenol-aerospace.com/serviceinstructions.asp

† Consult Amphenol Aerospace for current release of this contact or instruction sheet if applicable.

Daniels crimping tools are available from:
Daniels Mfg. Corp. 6103 Anno Ave., Orlando FL 32809

Coaxial Contacts

Contact Part Number Guide by Cable

LJT-R, MIL-DTL-38999 Series I; TV-R, MIL-DTL-38999 Series III; Amphe-Lite and SJT-R Series, SAE AS39029 (28, 59, 60, 75, 76, 77)

COAX CONTACTS FOR USE IN LJTR, TV-R, AMPHE-LITE AND SJT-R CONNECTORS

Contact Size	Cable	Installation Tools		Contact Part Number (Termination Instruction Sheet)**	
		Insertion	Removal	Pin	Socket
16	RG-178B/U, RG-196A/U			21-033122-564 (M39029/76-425) (L-2035-AG)	21-033123-564 (M39029/77-429) (L-2035-AJ)
	30-02033				
	30-02024				
	Haveg 30-00761			21-033122-562† (L-2035-AN)	21-033123-562† (L-2035-AR)†
	Tensolite 26723/A955KK1	M81969/8-07	M81969/8-08		
	Tensolite 24713/A955KK1	or	or		
	Haveg 61-02051	M81969/14-03	M81969/14-03	21-033122-561† (L-2035-AK)†	21-033123-561† (L-2035-AM) †
	Haveg 8100207	or	or		
	Raychem 7528H1424 AA3248	Amphenol 11-8674-16	Amphenol 11-8675-16		
	RG-161/U	11-8794-16	11-8795-16		
	RG-174A/U	or	or		
	RG-179B/U	MS27495A16	MS27495R16	21-033122-563 (M39029/76-424) (L-2035-AD)	21-033123-563 (M39029/77-428) (L-2035-AF)
	RG-187A/U	or	or		
	RG-188A/U	MS27534-16	MS27534-16		
RG-316/U					
Teledyne 11299					
Times (HS-179)					
12	Haveg 8100207				
	Raychem 7528H1424 AA3248				
	RG-161/U				
	RG-174A/U				
	RG-179B/U			21-033122-546 (M39029/28-211) (L-2035-F)	21-033123-546 (M39029/75-416) (L-2035-H)
	RG-187A/U	M81969/8-09	M81969/8-10		
	RG-188A/U	or	or		
	RG-316/U	M81969/14-04	M81969/14-04		
	Teledyne 11299	or	or		
	Times (HS-179)	Amphenol 11-8674-12	Amphenol 11-8675-12		
	Belden 1865A	11-8794-12	11-8795-12		
	Raychem 9528A1318	or	or		
	RG-180B/U	MS27495A12	MS27495R12	21-033122-541 (M39029/28-409) (L-2035-C)	21-033123-541 (M39029/75-417) (L-2035-D)
	RG-195A/U	or	or		
Raychem 5022E5111	MS27534-12	MS27534-12	21-033122-543† (L-2035-M) †	21-033123-543† (L-2035-P)	
Raychem 9530A5314			21-033122-544† (L-2035R)	21-033123-544† (L-2035-T) †	

NOTE: SAE AS39029 supersedes MIL-C-39029

CRIMPING TOOLS: Italicized letters in parenthesis that follow positioner part numbers indicate applicable die closure. Commercial equivalents with the same die closure dimension may be used.

CHART CONTINUES ON NEXT PAGE

† Consult Amphenol Aerospace for current release of this contact or instruction sheet if applicable.

†† When inner contact is installed by crimping only, 11-10134 Expander Tool Kit must be used to assemble rear insulator over contact.

** Termination instructions are packaged with each contact and can be found on-line at: www.amphenol-aerospace.com/serviceinstructions.asp

LJT-R, MIL-DTL-38999 Series I; TV-R, MIL-DTL-38999 Series III; Amphe-Lite and SJT-R Series, SAE AS39029 (28, 59, 60, 75, 76, 77)

COAX CONTACTS FOR USE IN LJt-R, TV-R, AMPHE-LITE AND SJT-R CONNECTORS					
Contact Size	Cable	Installation Tools		Contact Part Number (Termination Instruction Sheet)**	
		Insertion	Removal	Pin	Socket
12	Raychem 9527A1318	M81969/8-09 or M81969/14-04	M81969/8-10 or M81969/14-04	21-033122-545† (L-2035-U)†	21-033123-545† (L-2035-W)
	Raychem 9527A1314	Amphenol 11-8674-12	Amphenol 11-8675-12	21-033122-585 (L-2035-GG)	21-033123-585 (L-2035-GH)
	Gore GWN1159A	11-8794-12	11-8795-12	21-033122-547 (L-2035-X) †	21-033123-547 (L-2035-Z) †
	Nexans RG179-DT	MS27495A12 or MS27534-12	MS27495R12 or MS27534-12	21-033122-589 (L-2035-GR)	21-033123-589 (L-2035-GT)
	M/A-Com 5M2869-001				
8	Haveg 8100207	Hand inserted	11-9170 or MS	21-033102-023† (L-1107-C)	21-033101-023† (L-1107-G)
	Multi Flex 86				
	RG-161/U				
	RG-174A/U				
	RG-179B/U				
	RG-187A/U				
	RG-188A/U				
	RG-316/U				
	Teledyne 11299				
	T-Flex 405				
	Times (HS-179) AA3248				
	RG-142B/U			21-033102-024* (L-1107-D)	21-033101-024* (L-1107-H)
	RG-223/U				
SF-142 (solder inner conductor)					

NOTE: SAE AS39029 supersedes MIL-C-39029

NOTE: Contacts can be ordered by part numbers given in chart

CRIMPING TOOLS: Italicized letters in parenthesis that follow positioner part numbers indicate applicable die closure. Commercial equivalents with the same die closure dimension may be used.

† Consult Amphenol Aerospace for current release of this contact or instruction sheet if applicable

* When inner contact is installed by crimping only. 11-10134 Expander Tool Kit must be used to assemble rear insulator over contact.

** Termination instructions are packaged with each contact and can be found on-line at: www.amphenol-aerospace.com/serviceinstructions.asp

Coaxial Contacts

Contact Part Number Guide by Cable

LJT-R, MIL-DTL-38999 Series I; TV-R, MIL-DTL-38999 Series III; Amphe-Lite and SJT-R Series, SAE AS39029 (28, 59, 60, 75, 76, 77)

COAX CONTACTS FOR USE IN LJT-R, TV-R, AMPHE-LITE AND SJT-R CONNECTORS, CONT.

Contact Size	Cable	Installation Tools		Contact Part Number (Termination Instruction Sheet)**	
		Insertion	Removal	Pin	Socket
8	Haveg 51-03111	Hand inserted	11-9170 or MS	21-033102-022 (L-1107-B)	21-033101-022 (L-1107-F)
	Tensolite 28895/2X1				
	RG-180B/U			21-033102-021 (M39029/60-367 Supersedes MS27536) (L-1107-A)	21-033101-021 (M39029/59-366 Supersedes MS27535) (L-1107-E)
	RG-195A/U				
	Raychem 9528A1318				
	RD-316 Double Shield (M17/152-00001)				
	Filotex 124962			21-033102-025 (L-1107-J)	21-033101-025 (L-1107-N)
	Raychem 7524D5111-9 (triax cable - contact will terminate inner coax portion only)			21-033102-026 (L-1107-M)	21-033101-026 (L-1107-M)
	ECS3C058A				
	ECS352001			21-033102-027 (L-1286-B)	21-033101-027 (L-1293-B)
	ECS432101				
	RG-400				
	M17/028-RG-058				
	RG303			21-033102-029 (L-1107-AA)	21-033101-029 (L-1107-Y)†
	RG-58 (M17/155-00001)				
	Times LMR-195-UF				
	5021D1331-0			21-033102-036 (L-1107-P)	21-033101-036† (L-1107-Q)
	5M2869-001				
	BMS13-65			21-033102-037 (L-1107-V)	21-033101-037 (L-1107-W)
	ESC432101				
	5022A1311-0			21-033102-039 (L-1107-AC)	21-033101-036† (L-1107-AB)
	FA-19X			21-033652-001 (L-2091-A)	21-033653-001 (L-2091-B)
	HP-160				
	Multi Flex 141				
	Raychem 7524A1311			21-033102-041 (L-1107-AG)	21-033101-041 (L-1107-AF)
	T Flex-402				
	Utiflex UFB142G				
	Antenna x ANT-20014			21-033102-046	21-033101-046
Times AA-11209 (PT-180)	21-033102-047	21-033101-047			
EN4604-10	21-033102-048	21-033101-048			

NOTE: SAE AS39029 supersedes MIL-C-39029

NOTE: Contacts can be ordered by part numbers given in chart
CRIMPING TOOLS: Italicized letters in parenthesis that follow positioner part numbers indicate applicable die closure. Commercial equivalents with the same die closure dimension may be used.

† Consult Amphenol Aerospace for current release of this contact or instruction sheet if applicable

* When inner contact is installed by crimping only. 11-10134 Expander Tool Kit must be used to assemble rear insulator over contact.

** Termination instructions are packaged with each contact and can be found on-line at: www.amphenol-aerospace.com/serviceinstructions.asp

Matched Impedance Coaxial Contacts for MIL-DTL-38999

12 COAXIAL CONTACTS FOR RF/MICROWAVE, HIGH FREQUENCY AND HIGH PERFORMANCE REQUIREMENTS

The matched impedance coax contact is available in size 12. It incorporates a captivated inner contact which “snaps into” the outer contact preventing displacement or pull-back of the inner contact in situations where the cable may be bent.

Design features and benefits of the Matched Impedance:

- For use in 90 degree angle or bent cable applications
- Provides 50 Ohm and 75 Ohm matched impedance resulting in low VSWR and low insertion loss
- Frequency range for a mated pair extends to 3 GHz and beyond, higher than other coaxial contacts previously offered
- Ideally suited for D38999 high performance and MIL-STD-1760 high band coaxial contact requirements

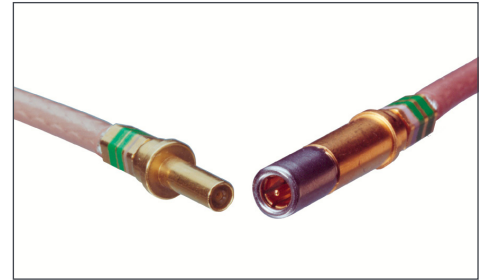

TYPICAL MATCHED IMPEDANCE COAX SOCKET CONTACT

has socket outer contact with a captivated pin inner contact

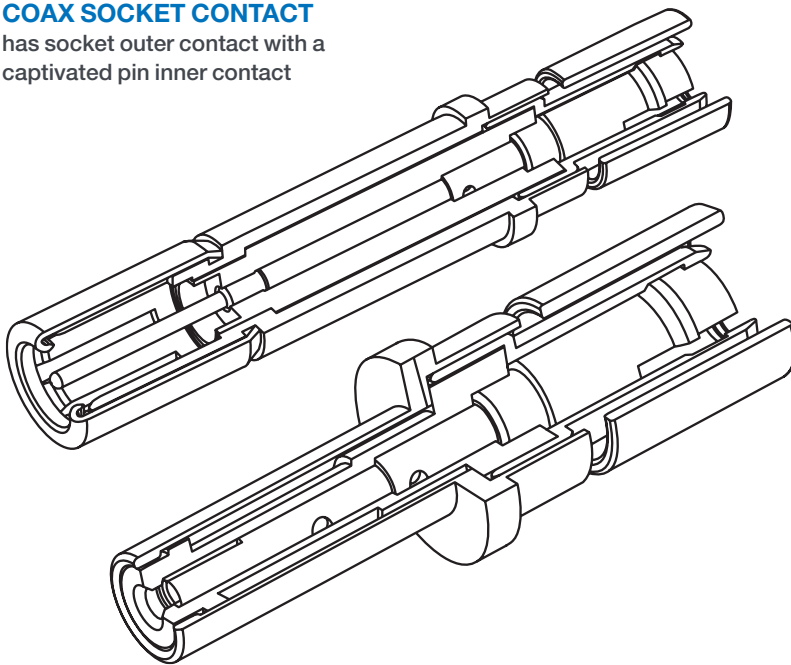

TYPICAL MATCHED IMPEDANCE COAX PIN CONTACT

has pin outer contact with a captivated socket inner contact

MATCHED IMPEDANCE COAX CONTACT PERFORMANCE

Electrical Specifications

Contact

Impedance: 50 Ohms nominal

Frequency Range:

0–3 GHz Operable at higher frequencies depending on cable selection.

Consult Amphenol for details.

Dielectric withstanding Voltage (for a mated pair):

- At sea level = 1000 VRMS
- At 50,000 ft. = 250 VRMS

Insulation

Resistance: 5 gigaohms min. @ 25°C

VSWR: 1.20 + .04F (F in GHz) max. up to 3 GHz

Insertion Loss:

- .11√ fGHz dB max.
- Size 12 75 Ohm cable to cable contacts limited to 2.1 GHz max
- Size 12 75 Ohm cable to PCB Pin limited to 3 GHz max
- Size 8 75 Ohm cable to cable contacts or cable to PCB limited to 3 GHz max

ENVIRONMENTAL SPECIFICATIONS:

Thermal

limits: –65°C to 175°C

MECHANICAL SPECIFICATIONS:

Mating: Slide-on

Mounting: Conforms to M39029/102 & /103 envelope dimensions (Size 12)

Matched Impedance Coaxial Contacts

for MIL-DTL-38999

HIGH PERFORMANCE SIZE 12 AND 8 COAX 50 OR 75 OHM MATCHED MIL-DTL-38999- LJT-R, SERIES I, JT-R, SERIES II, AND TV-R, SERIES III

Impedance (Ohms)	Contact Size	Use with Cable	Comment	Pin (Termination Instruction Sheet)**	Socket (Termination Instruction Sheet)**	
50	12	RG316	M39029/102/103	21-033651-011 (L-2092-C)	21-033650-011 (L-2092-C)	
		Semflex SM405				
		T-Flex-405				
		RG-316	JT-R, MIL-DTL-38999 Series II			21-033729-011 (L-2092-P)
		T-Flex-405				
		ET124962	M39029/102/103 Type	21-033651-017 (L-2092-F)	21-033650-017 (L-2092-F)	
		Filotex				
		M17/152-00001				
		RD316				
		JN1088WT	JN1104*50C	21-033213-042	21-033214-042 (L-2092-D)	
		JN1088WU	JN1104*50C	21-033213-043	21-033214-043	
		PAN6422XQ	PAN6841*50C	21-033651-012 (L-2092-E)	21-033650-012	
		Gore CXN 3403	M39029/102/103 Type	21-033651-018 (L-2092-K)	21-033650-018 (L-2092-K)	
		RG178				
		Gore CXN 3403	JT-R, MIL-DTL-38999 Series II		21-033729-018 (L-2092-K)	
		RG178				
		SFT-316-TR	M39029/102/103 Type	21-033651-022 (L-2092-N)	21-033650-022 (L-2092-N)	
		Semflex SW060	M39029/102/103 Type	21-033651-025	21-033650-025	
Semflex SW086 (solid inner conductor)	M39029/102/103 Type	21-033651-026	21-033650-026			
75		RT179, RG179		21-033651-030 (L-2092-AM)	21-033650-030 21-033729-030 (Series II)	
		PIC V73263		21-033651-031 (L-2092-AM)	21-033650-031 21-033429-031 (Series II)	
		S86208		21-033651-041	21-033650-041 21-033729-041 (Series II)	
		VDM230				
75	8	RG-179†		21-033592-001 (L-1107-AP)	21-033591-001 (L-1107-AP)	
		PIC V76261		21-033592-021 (L-1107-AL)	21-033591-021 (L-1107-AL)	
		PIC V73263				
		Whitmore/Wirenetics W-4200-1135		21-033592-031 (L-1107-AR)	21-033591-031 (L-1107-AR)	
		179DT				
		Belden 1855A				
		VDM230				
V78209		21-033592-041 (L-1107-AU)	21-033591-041 (L-1107-AU)			

Size 12 75-Ohm crimp to crimp limited to 2.1 GHz

Size 12 75-Ohm to PCB tail limited to 5 Gbps (2.5 GHz)

** Termination instructions are packaged with each contact and can be found on-line at:

www.amphenol-aerospace.com/serviceinstructions.asp

† Consult Amphenol Aerospace for current release of this contact or instruction sheet if applicable

* Add P or S for pin or socket

† 21-033591-XXX sockets will only mate with Amphenol 21-0333592-XXX pins

PCB CONTACTS -75 OHMS MATCHED IMPEDANCE CONTACTS

Contact Size	Length	Pin	Socket
8	0.525	21-033599-001	21-033590-001
	0.739	21-033599-031	
	0.833	21-033599-021	
	0.849	21-033599-041	
	0.886		21-033596-031
12	0.518	21-033686-023	
	0.847	21-033686-026	
	0.850		21-033614-151
	1.244	21-033686-027	

High Frequency Coax Contacts

Series III Circular General Description

AMPHENOL HIGH FREQUENCY CONTACTS

Amphenol and SV Microwave (an Amphenol company) offer DC to 40 GHz high frequency size 8, 12 and 16 coaxial contacts for the D38999 Series III housing and standard inserts. These contacts allow any application to continue to use the D38999 connector and be able to expand the use to include the microwave transmission lines. Features include:

- Superior electrical performance and high frequency capability
- Blindmate advantage and maintenance of an accurate phase length when mated
- Can be terminated to a multiple of cable types depending on the application
- Uses standard interfaces based on MIL-STD-348, and can be installed in any MIL-DTL-38999 size 8, 12 or 16 insert
- Unique “Float Mount” technology allows for consistent microwave performance while maintaining tight mechanical tolerances



Subminiature MIL-DTL-38999 Series III Connector with Size 8 High Frequency Contacts

SPECIFICATIONS HIGH FREQUENCY CONTACTS

Electrical (Mated pair size 8 - RG 405 Semi-Rigid Cable)

Impedance:	50 Ohm
Frequency Range:	DC - 40 GHz
VSWR:	1.05 +.01 (freq. GHz)
Insertion Loss:	0.03. $\sqrt{\text{freq. GHz}}$
Insulation Resistance (Min.):	10,000 m Ohm
Contact Resistance (Max.)	
• Center conductor:	6.0 m Ohm
• Outer conductor:	3.0 m Ohm
• Outer to cable:	0.5 m Ohm
Dielectric Withstanding Voltage:	1,000 VRMS
Corona Extinction Voltage:	250 VRMS
RF High Potential Voltage:	500 VRMS
RF Leakage:	-(80-freq. GHz)

MATERIALS AND FINISH

Body and Sleeve:	Stainless steel per AMS-5640 Alloy UNS S30300 Type 1
Ferrule:	Brass per ASTM B16, Alloy UNS C36000
Contact & Lock Ring:	Beryllium copper per ASTM B196 Alloy UNS C17300, Td04
Insulator:	PTFE per ASTM D1710, Type 1, Grade 1, Class B
Spring:	Stainless steel per ASTM A313 Type 631
Rear Body & Contacts:	Gold per ASTM B488 Type II, Code C, Class 1.27; over Nickel per AMS-QQ-N-290 Class 1 (60 μ inches); over Copper per MIL-C-14550 (10 μ inches) Passivated per AMS-2700, Type 2

ENVIRONMENTAL

Temperature Range:	-65°C to +125°C
Corrosion (Salt Spray):	MIL-STD-202, Method 101, Condition B
Vibration:	MIL-STD-202, Method 204, Condition D, 20 Gs
Shock:	MIL-STD-202, Method 213, Condition 1, 100 Gxs
Thermal Shock:	MIL-STD-202, Method 107, Condition B, -65°C to +125°C
Moisture Resistance:	MIL-STD-202, Method 106, Less step 7B
Barometric Pressure (Altitude):	MIL-STD-202, Method 105, Condition C, 70,000 ft.

High Frequency Coax Contacts

HIGH FREQUENCY COAX CONTACTS FOR USE IN D38999, SERIES III CONNECTORS							
Cavity Size	Frequency	Interface	For use with Cable	*Piggyback Grommet	SV#	Type	Amphenol Part Number (Termination Instruction Sheet)**
8	2 GHZ	BMZ	RG-179	21-033321-007		Socket	21-033449-11HF
						Pin	21-033448-11HF
		BMZ-75 Ohm	LMR-240-75	21-033321-008		Socket	21-033449-08HF
						Pin	21-033448-08HF
	12 GHZ	BMZ	RG-400/ RG-142	21-033321-009		Socket	21-033449-03HF (300-89-008)
						Pin	21-033448-03HF (300-89-008)
	18 GHZ	BMZ	FA19X	N/A	SF9351-60031 SF9341-60019	Socket	21-033449-17HF
						Pin	21-033448-17HF
		BMZ	TFLEX-405	21-033321-007		Socket	21-033449-02HF (300-89-009)
						Pin	21-033448-02HF (300-89-009)
		BMZ	TFLEX-402	21-033321-010		Socket	21-033449-04HF (300-89-002)
						Pin	21-033448-04HF (300-89-002)
	26.5 GHZ	BMA	TFLEX-405	21-033321-007		Socket	21-033449-06HF
						Pin	21-033448-06HF
BMA		TFLEX-402	21-033321-010		Socket	21-033449-07HF	
					Pin	21-033448-07HF	
40 GHZ	BMZ	TFLEX-405	21-033321-007		Socket	21-033449-01HF (300-17-008)	
					Pin	21-033448-01HF (300-17-008)	
12	34 GHZ	SERIES II	V76261	N/A	SF9351-60028 SF9341-40015	Socket	21-033449-16HF
						Pin	21-033448-16HF
	65 GHZ	SMPM	TFLEX-405	N/A		Socket	21-033449-09HF
						Pin	21-033448-09HF
16	3.0 GHZ	SERIES II	RG-179	N/A	SF9351-40007	Socket	21-033449-14HF
						Pin	21-033448-14HF
	65 GHZ	SMPS	0.047 Dia. Cable	N/A		Socket	21-033449-10HF
						Pin	21-033448-10HF

* Piggyback grommet is not supplied with contacts and must be ordered separately

** Termination instructions are packaged with each contact and can be found on-line at:
www.amphenol-aerospace.com/serviceinstructions.asp

Concentric Twinax Contacts

General Description, Application Data - Size 8

SIZE 8 CONCENTRIC TWINAX CONTACTS

The size 8 concentric Twinax contact was developed for use in MIL-STD-1553 Airborne multiplex data bus applications which require high performance interconnect characteristics in multi-pin connectors. Ideal for this application need is the high performance Tri-Start connector with its fully scoop-proof feature of recessed pins. The concentric Twinax contact is crimp terminable to twisted shielded cable.

FEATURES INCLUDE:

- Protection from magnetic and electrostatic interference including nuclear electromagnetic pulse
- Shield integrity through a multi-pin circular connector and does not require contact polarization within the insert
- 175°C rated and meets performance levels of MIL-DTL-38999 Series III connectors
- MIL-C-17/176-00002 cable termination
- Gold plated full crimp termination contacts qualified to M39029/90 & /91
- Integral part of the MIL-STD-1760 interconnection system
- Also available in modified, intermateable versions for termination to a host of cables (See chart on next page)

TYPICAL ELECTRICAL PERFORMANCE

Size 8 Concentric Twinax Contacts

Voltage Rating:

- 500 Vrms max. @ sea level

Contact Resistance:

- Center @ 1 Amp, 55 millivolts max. voltage drop @ 25°C
- Intermediate @ 1 Amp, 55 millivolts max. voltage drop @ 25°C
- Outer @ 12 Amps, 75 millivolts max. voltage drop @ 25°C
- Operating Frequency: 0–20 MHz

Dielectric Withstanding Voltage:

- Center to Intermediate: 1000 VAC Rms @ Sea Level
- Intermediate to Outer: 500 VAC Rms @ Sea Level

SHORT PROFILE TWINAX CONTACT OPTION

A Short Profile size 8 Twinax is available that can be used with a low profile right angle backshell and can offer increased packaging efficiency. Consult Amphenol Aerospace for further information.

TWINAX CABLE IN DATA BUS SYSTEMS

Benefits:

- Protection from magnetic interference
- Protection from electrostatic interference including nuclear electromagnetic pulse
- Meets parameters defined by MIL-STD-1553B
- Maintains shield integrity through a multi-pin circular connector and does not require contact polarization within the insert

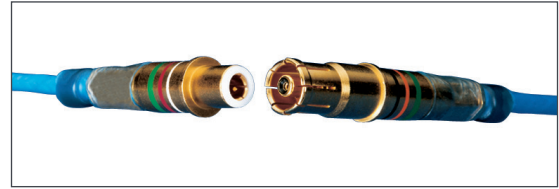

Concentric Twinax Contacts Size 8



Short Profile Twinax vs
Standard Length Twinax Contact

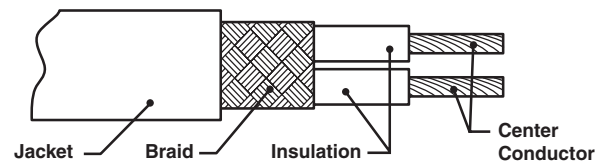

CABLE ILLUSTRATION - TWINAX CONTACT

Concentric Twinax Contacts

Contact Part Number Guide by Cable

SIZE 8 CONCENTRIC TWINAX CONTACTS FOR USE IN D38999 CONNECTORS

Connector Series	For use with Cable	Comments	Size 8 Concentric Twinaxial Contact Part Number (Termination Instruction Sheet)**	
			Pin	Socket
	M17/176-00002	AS39029/113-625 & /114-628 (Amphenol) Supplied with heat shrink seal	21-033190-625 (L-1253-AG)	21-033191-628 (L-1253-AG)
D38999 Series I, III	5PTM1T04-2	AS39029/90/91 (Amphenol) Supplied with heat shrink seal	21-033190-529 (L-1253-A)	21-033191-530 (L-1253-B)
	M17/176-00002, PIC 6771553			
	M17/176-00002, PIC 6771553	M39029/90/91 (Pyle) Supplied with heat shrink seal	T3-46T08-LD (PN-430)	T3-47T08-LD (PN-430)
	M17/176-00002, PIC 6771553	Without seals	21-033190-000 (L-1253-A)	21-033191-000 (L-1253-B)
	M17/176-00002, PIC 6771553	Supplied with piggyback grommet seal	21-033190-001 (L-1253-A)	21-033191-001 (L-1253-B)
	5M2022-003	Without seals	21-033190-026 (L-1253-AA)	21-033191-026†
	Raychem 10612			
	05A0771			
	7724C8664			
	EPD22189B			
	GC875TM24H			
	Raychem 10614			
	T10971	Supplied with heat shrink seal	21-033190-027 (L-1253-K)	21-033191-027 (L-1253-L)
	23089/RC			
	PAN711-6421			
	Raychem 10613	Supplied with piggyback grommet seal	21-033190-029 (L-1253-K)	21-033191-029 (L-1253-L)
	23089/RC			
	PAN711-6421			
	Raychem 10613	Without seals	21-033190-030 (L-1253-K)	21-033191-030 (L-1253-L)
	23089/RC			
	PAN711-6421			
	Raychem 10613	Supplied with heat shrink sleeve	21-033190-040 (L-1253-S)	21-033191-040 (L-1253-T)
	7726D0664			
	ASNE 08072003-09			
	GSC-12-2548-00	Supplied with piggyback grommet seal	21-033190-081 (L-1253-W)†	21-033191-081 (L-1253-Y)†
	Axon P517417			
	5M2022-003			
	Raychem 10612	Supplied with heat shrink seal	21-033190-261 (L-1253-AA)	21-033191-261†
	5M2022-003			
	Raychem 10612			
7724C8664	Without seals	T3-46TB08-LD (PN-494)	T3-47TB08-LD (PN-494)	
Raychem 10614				
7820D0111 (20 AWG)	Without seals	T3-467C08-LD (PN-537)	T3-477C08-LD (PN-537)	
Gore CXN2268	Short profile Supplied with heat shrink seal (.465)	T3-46TE08-LD (PN-1001)	T3-47TE08-LD (PN-1001)	
M17/176-00002, PIC 6771553	Short profile Supplied with heat shrink seal (.465)	T3-46TD08-LD (PN-1000)	T3-47TD08-LD (PN-1000)	
M17/176-00002, PIC 6771553	Short profile Without seals (.263)	21-033910-015† (PN-1005)	21-033922-015 (PN-1005)	
M17/176-00002, PIC 6771553	Short profile Supplied with piggyback grommet seal (.465)	21-033617-001 (REF PN-100)	21-033922-015 (PN-1005)	
Gore CNX2702	Short profile Supplied with heat shrink seal (.465)	T3-46TF08-LD (PN-1002)	T3-47TF08-LD (PN-1002)	
M17/176-00002, PIC 6771553	Short profile Without seals (.303)		P-209546-27†	

** Termination instructions are packaged with each contact and can be found on-line at: www.amphenol-aerospace.com/serviceinstructions.asp

† Consult Amphenol Aerospace for current release of this contact or instruction sheet if applicable.

Concentric Twinax Contacts

Contact Part Number Guide by Cable

SIZE 8 CONCENTRIC TWINAX CONTACTS FOR USE IN D38999 CONNECTORS				
Connector Series	For use with Cable	Comments	Size 8 Concentric Twinaxial Contact Part Number (Termination Instruction Sheet)**	
			Pin	Socket
D38999 Series I, III	0024A0024	Without seals	21-033190-070 (L-1253-U)	21-033191-070 (L-1253-V)
	Fileca F2709-13-CA			
	HS5930			
	S280W502-1			
	Raychem 10602 0024G0024			
	0024A0024	Supplied with piggyback grommet seal	21-033190-071 (L-1253-U)	21-033191-071 (L-1253-V)
	Fileca F2709-13-CA			
	HS5930			
	Raychem 10602 0024G0024			
	S280W502-1			
	Tensolite 24463/9P025x-2(LD)	Supplied with heat shrink seal	21-033190-072 (L-1253-U)	21-033191-072 (L-1253-V)
	0024A0024			
	Fileca F2709-13-CA			
	HS5930			
	Raychem 10602 0024G0024			
	S280W502-1	Without seals	21-033190-090†	21-033191-090 (L-1253-AD)
	0024A0311			
	PIC E10244	Supplied with piggyback grommet seal	21-033190-091†	21-033191-091 (L-1253-AD)
	0024A0311			
	PIC E10224	Supplied with heat shrink seal	21-033190-092†	21-033191-092 (L-1253-AD)
0024A0311				
PIC E10224	M39029/113-625 & /114-628 Supplied with heat shrink seal	21-033190-625 (L-1253-AG)	21-033191-628 (L-1253-AG)	
M17/176-00002				

** Termination instructions are packaged with each contact and can be found on-line at:
www.amphenol-aerospace.com/serviceinstructions.asp

† Consult Amphenol Aerospace for current release of this contact or instruction sheet if applicable.

Concentric Twinax Contacts

General Description, Contact Part Number Guide by Cable

AMPHENOL TWINAX CONTACTS

SIZE 10 & 12 CONCENTRIC TWINAX CONTACTS

The size 12 concentric twinax contact interface was developed for JN1104 EuroFighter contacts, and can be used in any size 12 cavity M38999 I, II or III or SJT connector.

FEATURES:

- Operating temperature -65°C to 175°C
- Pins are scoop-proof
- Meets performance levels of M38999 connector
- 4 components, gold plated crimp termination
- For use with a variety of cables (See chart below)

TYPICAL ELECTRICAL PERFORMANCE

Size 10 & 12 Concentric Twinax Contacts

Voltage Rating:

- 500 Vrms max. @ sea level

Contact Resistance:

- Center @ 1 Amp, 55 millivolts max. voltage drop @ 25°C
- Intermediate @ 1 Amp, 55 millivolts max. voltage drop @ 25°C
- Outer @ 12 Amps, 85 millivolts max. voltage drop @ 25°C
- Operating Frequency: 0-30 MHz

Dielectric Withstanding Voltage:

- Center to Intermediate 800 VAC Rms @ Sea Level
- Intermediate to Outer 500 VAC Rms @ Sea Level



Concentric Twinax Contacts Size 12

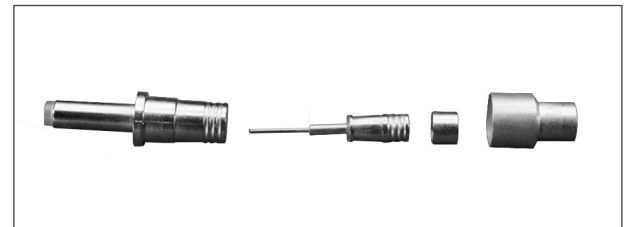

Unassembled Components of Size 12 Concentric Twinax Contact

SIZE 10 & 12 CONCENTRIC TWINAX CONTACTS FOR USE IN D38999 CONNECTORS

Connector Series	Contact Size	For use with Cable	Comments	Concentric Twinaxial Contact Part Number (Termination Instruction Sheet)**	
				Pin	Socket
D38999 Series I, III	10	5M2022-003	Supplied with Thermal fit sleeve	21-033844-001 (L-1255-A)	21-033843-001 (L-1255-B)
D38999 Series I, III	12	M17/176-00002	JN1104 Interface	21-033909-025 (L-2092-G)	21-033908-025 (L-2092-G)
		ST5M1212-002			
		TWC-78-1			
		G771553			
		0024A0024			
		5M 2022-003			
		Fileca F2709-13-CA			
		10612			
		EPD32263A			
		GSC-12-2548-00			
		5PTM1T04-1	Same as -91 except new ferrule with wire support	21-033909-101 (L-2092-AC)	21-033908-101 (L-2092-AC)
		ASNE0849			
		VG95218T023D002			
		55PC1221-24			
D38999 Series II	12	VG95218T023D002	JN1104 Interface	21-033909-131	21-033908-131
		M27500A22D2T23			
		GSC-12-2549-00			
		M17/176-00002			
		0024A0024			21-033640-028 (L-2092-V)

** Termination instructions are packaged with each contact and can be found on-line at: www.amphenol-aerospace.com/serviceinstructions.asp

AMPHENOL TRIAX CONTACTS

Provide additional shielding when terminated to triax cable having solid or stranded center conductors. Amphenol supplies triax contacts in sizes 8, 10 and 12 and they are ideally suited for use in D38999 Series I, II and III circular connectors.

FEATURES AND BENEFITS:

- Incorporates three conductors, designed for use with triax cable
- Each of the three conductors are separated by dielectric insulation to isolate ground planes
- Shielding effectiveness is improved with two isolated shields
- May be specified for direct connection to printed circuit boards
- May be mixed with coax, twinax and power contacts in a single connector



Triax Size 8 Pin Contact



Triax Size 12 Socket Contact

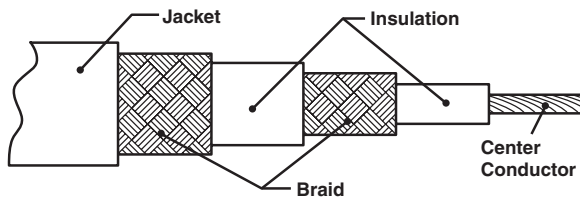

Cable Illustration - Triax Contact

TYPICAL ELECTRICAL PERFORMANCE

Size 8, 10 and 12 Triax Contacts

Contact Resistance:

- Center @ 1 Amp, 120 millivolts max. voltage drop @ 25°C
- Intermediate @ 1 Amp, 60 millivolts max. voltage drop @ 25°C
- Outer @ 12 Amps, 90 millivolts max. voltage drop @ 25°C

Operating Frequency:

- Size 12: 0-30 MHz
- Size 10: 0-300 MHz
- Size 8: 0-500 MHz

Dielectric Withstanding Voltage:

- Center to Intermediate 800 VAC Rms @ Sea Level
- Intermediate to Outer 500 VAC Rms @ Sea Level

Insulation Resistance:

- 1000 megohms minimum @ 25°C

Triax Contacts

Contact Part Number Guide by Cable

SIZE 8, 10 & 12 TRIAX CONTACTS FOR USE IN D38999 SERIES I & III CONNECTORS				
Size	For use with Cable	Comments	Size 8, 10, 12 Triax Contact Part Number (Termination Instruction Sheet)**	
			Pin	Socket
8	28883/02060X-1			
	5M2397-002			
	7528A5314			
	81264-02			
	Champlain 81-00321A			
	RGX-179		21-033198-003 (L-1254-F)	21-033197-003 (L-1254-E)
	RT-179			
	RTG 179			
	Tensolite 28883/02060X-1(LD)			
	Thermatics 12447			
	Times RT316 (AA-6861)			
	PAN6595XM			
	752866314		21-033198-011 (L-1254-V)	21-033197-011 (L-1254-T)
	7528G6314			
	5M2559-001			
	81264-01		21-033198-004 (L-1254-D)	21-033197-004 (L-1254-C)
	Cheminax 9530F5214			
	Teledyne 13809			
	Tensolite 28598/9J063T-1			
	ST5M1323-001			
Champlain 81-00700		21-033198-010 (L-1254-S)	21-033197-010 (L-1254-S)	
Teledyne 11914/1				
Tensolite 26895/90334X-1				
Times AA6603				
Tyco 7530A5314		21-033198-014	21-033197-014	
10602 (Twinax)	Special design with triax mating end and twinax cable termination	21-033724-015 (L-1255-C)	(Consult with Amphenol for availability)	
RT316		21-033198-031	21-033197-031	
Pic L7626TX (75 Ohm)		21-033198-015	21-033197-015	
Gore GSC-03-81497-00		21-033198-041	21-033197-041	
ST5M1322-001 (AA2317)		21-033198-051	21-033197-051	
10	5M2397-002		21-033800-001 (L-1256-A)	21-033801-001 (L-1256-B)
12	JN1088WT (50 Ohm)	JN1104 Interface	21-033909-012 (L-1256-J)	21-033908-012 (L-1256-J)
	JN1088WU (75 Ohm)			
	GSC-03-81497-00 (75 Ohm)	Replaced by -33 with improved rear insulator	21-033909-023 (L-1256-M)	21-033908-023 (L-1256-M)
	GSC-03-81497-00 (75 Ohm)	JN1104 Interface	21-033909-033 (L-1256-P)	21-033908-033 (L-1256-P)
	540-1050-000 (75 Ohm)		21-033909-071 (L-1256-AA)	21-033908-071 (L-1256-AA)
	Axon RGX-179			
	Harbour TRX179			
Times Microwave AA-6151 (RT-179)				

** Termination instructions are packaged with each contact and can be found on-line at: www.amphenol-aerospace.com/serviceinstructions.asp

AMPHENOL PRINTED CIRCUIT TAIL CONTACTS

Contacts are currently supplied as follows:

- 8, 12 and 16 Coax
- 8, 10 and 12 Twinax
- 8 Triax (socket only)

PC Tail shielded contacts provide a cost effective packaging solution for limited space applications where connectors are attached to printed circuit boards. High reliability is assured with factory pre-assembled contacts and standardization termination to the board.

PC Tail contacts are available for MIL-DTL-38999 Series I and III circular connectors and also for ARINC 404, ARINC 600 and R27 rectangular connectors. The following pages show the available PC Tail contact part numbers for 38999 Circular connectors. See page 41 for information on twinax contacts for ARINC Rectangular connectors along with compatible cable terminations. Consult Amphenol Aerospace for further information on the applicable tooling for these contacts.

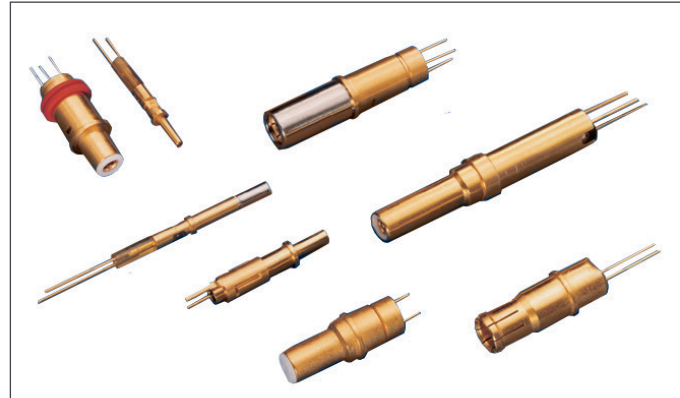

PC Tail Coax and Twinax Contacts for Attachment to Printed Circuit Boards

TYPICAL ELECTRICAL PERFORMANCE

Size 8, 12 & 16 PC Tail Coax Contacts

Contact Resistance:

- Center @ 1 Amp, 55 millivolts max. voltage drop @ 25°C
- Outer @ 1 Amp, 55 millivolts max. voltage drop @ 25°C
- Operating Frequency: 0–500 MHz

Dielectric Withstanding Voltage:

- Center to Outer 500 VAC Rms @ Sea Level

Insulation Resistance:

- 1,000 megohms minimum @ 25°C

TYPICAL ELECTRICAL PERFORMANCE

Size 8, 10 & 12 PC Tail Twinax Contacts

Contact Resistance:

- Center @ 1 Amp, 55 millivolts max. voltage drop @ 25°C
- Intermediate @ 1 Amp, 55 millivolts max. voltage drop @ 25°C
- Outer @ 1 Amp, 55 millivolts max. voltage drop @ 25°C
- Operating Frequency: 0–20 MHz

Dielectric Withstanding Voltage:

- Center to Intermediate 500 VAC Rms @ Sea Level
- Intermediate to Outer 500 VAC Rms @ Sea Level

Insulation Resistance:

- 1,000 megohms minimum @ 25°C

TYPICAL ELECTRICAL PERFORMANCE

Size 8 PC Tail Triax Contacts

Contact Resistance:

- Center @ 1 Amp, 55 millivolts max. voltage drop @ 25°C
- Intermediate @ 1 Amp, 55 millivolts max. voltage drop @ 25°C
- Outer @ 1 Amp, 55 millivolts max. voltage drop @ 25°C
- Operating Frequency: 0–500 MHz

Dielectric Withstanding Voltage:

- Center to Intermediate 500 VAC Rms @ Sea Level
- Intermediate to Outer 500 VAC Rms @ Sea Level

Insulation Resistance:

- 1,000 megohms minimum @ 25°C



Size 8, PC Tail Twinax Socket Contact for use in D38999 Connectors



D38999 Connector with PC Tail Coax Contacts, Sealing Plugs in unused contact cavities and PC Tail Alignment Disc

Coax, Twinax & Triax PC Tail Contacts

Contact Part Number Guide

PC TAIL COAX, TWINAX, AND TRIAX CONTACTS FOR USE IN D38999 SERIES I & III CONNECTORS						
Size	Tails*	Comments	PC Tail Coax Contact Part Number	PC Tail Twinax Contact Part Number	PC Tail Triax Contact Part Number	
8 Pin	PCB 2 tails		21-033733-007			
		For epoxy filled connector	21-033733-002			
		For epoxy filled connector	21-033733-004			
			21-033733-009			
			21-033733-008			
	PCB 4 outer tails, 1 inner		21-033733-005			
	PCB 3 tails	M39029/90/91 Interface			21-033967-115	
					21-033967-125	
					21-033967-015	
					21-033967-045	
					21-033967-055	
					21-033967-065	
					21-033967-085	
					21-033967-095	
	PCB 9 tails				P-209550†	
				P-209532-1		
				P-209532-2		
PCB 3 tails					21-033828-001	
					21-033828-021	
					21-033828-041	
8 Socket	PCB 2 tails		21-033426-001			
		M39029/91 Interface Outer body grounded to shell			DB-109002	
					21-033919-015	
	PCB 3 tails				21-033919-025	
				21-033426-021	21-033921-015	
				21-033426-041	21-033921-025	
					21-033921-045	
					21-033921-035	
					21-033921-065	
					21-033921-075	
					21-033921-115†	
			AS39029/114 Type (with hood)			21-033479-001
		AS39029/114 Type (with hood)			21-033479-021	
		M39029/90/91 Interface .040 dia. tails			21-033921-105†	
	PCB 2 tails	Outer body grounded to shell				21-033840-021
Outer body grounded to shell					21-033841-001	
PCB 3 tails					21-033840-001	
10 Pin	PCB 2 tails	Outer body grounded to shell		21-033844-002†		

* Consult Amphenol Aerospace for tail configurations and tail diameters.

† Consult Amphenol Aerospace for current release of this contact.

Coax, Twinax & Triax PC Tail Contacts

Contact Part Number Guide

PC TAIL COAX, TWINAX, AND TRIAX CONTACTS FOR USE IN D38999 SERIES I & III CONNECTORS				
Size	Tails*	Comments	PC Tail Coax Contact Part Number	PC Tail Twinax Contact Part Number
12 Pin	PCB 2 tails		21-033686-008	
		Outer tail clip type	21-033686-009	
			21-033686-005	
			21-033686-010	
		Outer tail clip type	21-033686-013	
		For epoxy filled connector	21-033687-006	
			21-033687-007	
			21-033686-016†	
12 Socket	PCB 2 tails		21-033614-001	
			21-033614-021	
			21-033614-041	
		Outer tail clip type	21-033611-003	
	Outer tail clip type, M38999 Series II	21-033430-001		
	M38999 Series II	21-033430-021		
PCB 3 tails		21-033440-001		
	M38999 Series II	21-033430-041		
16 Pin	PCB 1 tail	Outer body grounded to shell	21-033634-015	
		Outer body grounded to shell	21-033634-035	
			21-033634-045	
	PCB 2 tails		21-033856-015	
			21-033856-065	
			21-033386-001	
	PCB 90 degree, 2 tails		21-033856-025	
16 Socket	PCB 2 tails		21-033857-001	
			21-033857-008	
			21-033857-007	
			21-033610-001	
			21-033610-002	
			21-033441-001	
		M38999 Series II	21-033606-001	
			21-033606-021†	
			21-033606-031†	
			21-033610-003	
		21-033857-003		
12 Pin	PCB 4 tails	JN1104 Interface		21-033633-001†**
			21-033633-002**	
			21-033633-006**	
			21-033633-007**	
12 Socket	PCB 4 tails	M38999 Series II, JN1104 Interface		21-033393-006**
				21-033393-005**
				21-033433-001**

* Consult Amphenol Aerospace for tail configurations and tail diameters.

** Size 12 twinax and triax contacts are intermatable.

† Consult Amphenol Aerospace for current release of this contact.

MRC Connectors

High Speed Micro-Miniature Series



OVERVIEW

Amphenol Aerospace now offers a connector series that can be used for all of your multi-media needs. This series is capable of running Gigabit Ethernet, USB 2.0/USB 3.0, HDMI and 10 Gigabit Ethernet when specified and designated to a specific configuration. MRC is a micro-miniature connector ideal for Commercial, Industrial and Military Communication Systems.

The MRC flange mounting plugs are supplied with rigid contacts that are flat to the front surface of the connector. This feature allows it to be used in applications such as ruggedized displays, radios, and routers that have potential to come in contact with dirt and sand during use. The MRC can be easily cleaned by simply wiping off debris whereas standard pin and socket style connectors tend to be more difficult to remove debris once it has been compacted in the contacts.

The MRC cable assemblies feature connectors with spring loaded contacts and two coupling styles (Push/Pull and Push w/ ¼ turn lock). Both of these coupling styles mate with the standard flange mounting plug. Cable assemblies are available in various lengths and can either be supplied as double ended with MRC connectors on both ends or with standard COTS RJ45, USB, HDMI connections on one end. Additional cable materials and connector configuration are available; please consult our product team with your requirements.

MRC SERIES SPECIFICATIONS

CURRENT RATING	2.5 AMPS Max Per Contact
PROTOCOLS SUPPORTED	Gigabit Ethernet, USB 2.0/3.0, 10 Gigabit Ethernet, & HDMI
DURABILITY	2000 Mating Cycles
UNMATING FORCE	4 lb. Min
TEMPERATURE RANGE	See Individual Connector Pages

MATERIALS & FINISHES

SHELLS	Aluminum Alloy
CONTACTS	Copper Alloy, Gold Plated
INSULATORS	Polyphenylene Sulfide (PPS), Teflon
CANTED COIL SPRING	Stainless Steel, Gold Plated

MRC - 9 Pin Mount Plug

How to Order

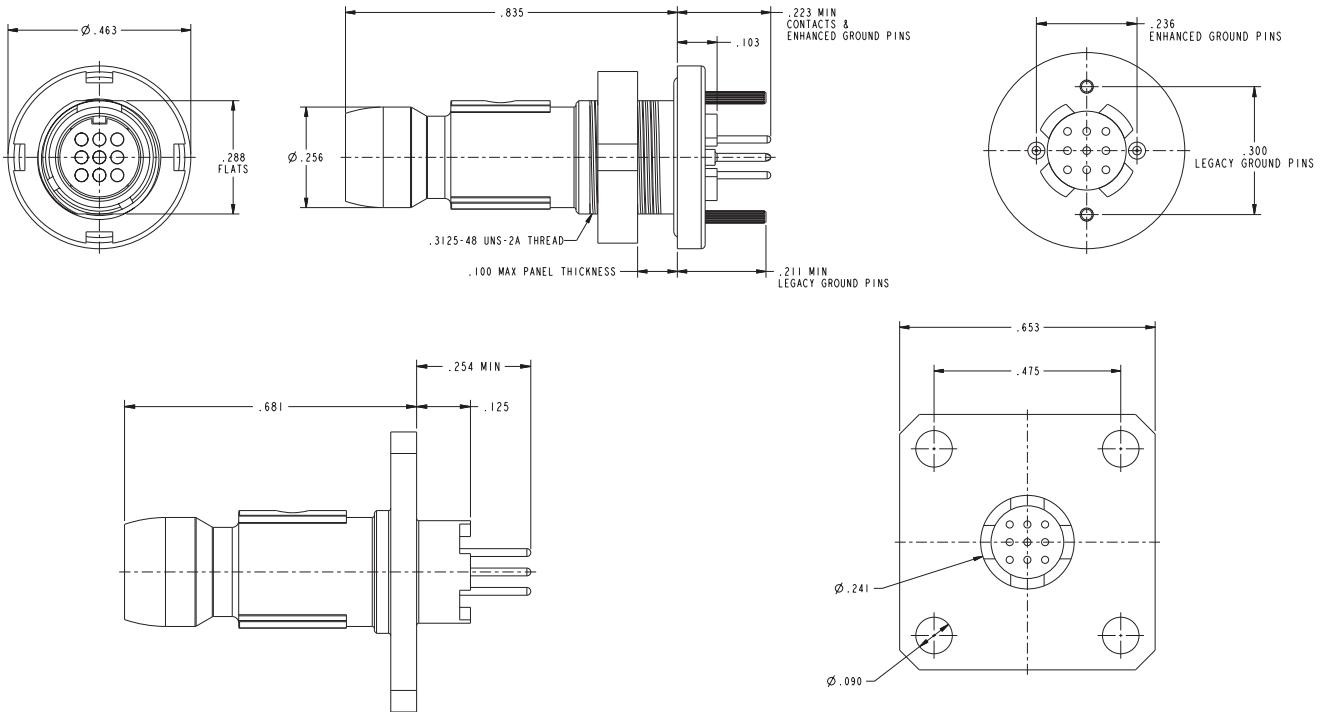

1. Series	2. Shell Style	3. Service Class	4. Alternate Keying Positions	5. Grounding Pins
MRC9	7	C	N	G

*Omit grounding pins for square flange.

1. SERIES

MRC9 9 Pin MRC Connector

2. SHELL STYLE

7 PC Jam Nut Panel Mount Plug
2 PC Square Flange*

*Only mates with a Push-Pull style Receptacle

3. SERVICE CLASS

Finish
C OD Cadmium
E Electroless Nickel
D Durmalon
Z Black Zinc Nickel
G Green Zinc Nickel
B Black Electroless Nickel

4. ALTERNATE KEYING POSITION

Key Position	AB°	AC°
N	120	210
A	150	210
B	95	210
C	120	275
D	150	275

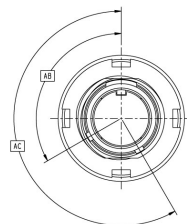

5. GROUNDING PINS

Omit	Legacy Ground Pins - inactive for new design
G	Enhanced Ground Pin
N	Non-grounded

FOR JAMNUT ONLY

TEMPERATURE

-55° C to 175° C

SPANNER NUT TOOL

11-013020-005

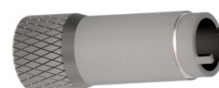

Ethernet Cable Assemblies

How to Order

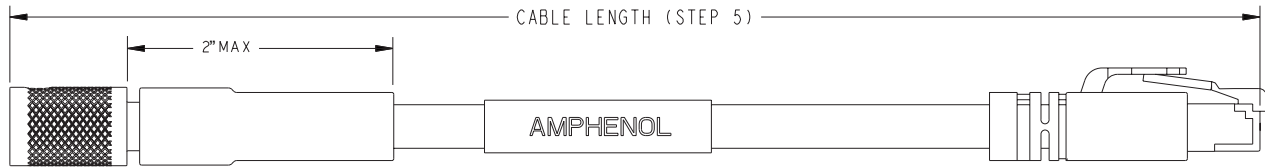

1.	2.	3.	4.	5.	6.	TEMPERATURE
Series	Cable End A	Service Class	Alternate Keying Position (Side A)	Cable Length in Inches	Cable End B	
MRC9	1	C	N	24	EM	-20° C to 75° C

1. SERIES

MRC9	9 Pin MRC Connector
-------------	---------------------

5. CABLE LENGTH

Determine the overall length of your cable from end to end in inches. For Ex. 24 = 24 Inches.
Note: 12 inch Minimum

2. SHELL STYLE

	Cable End A
1	Push-pull Receptacle (Spring Contacts)
3	Twist-lock Receptacle (Spring Contacts)

6. SHELL STYLE

	Cable End B
EM	Ethernet RJ45 Male Cat 6
E1	Push-pull Receptacle (Spring Contacts)
E3	Twist-lock Receptacle (Spring Contacts)
EMZ	Ethernet RJ45 Male Cat 6, LSZH
EIZ	Push-pull Receptacle (Spring Contacts), LSZH
E3Z	Twist-lock Receptacle (Spring Contacts), LSZH

3. SERVICE CLASS

	Finish
C	OD Cadmium
E	Electroless Nickel
D	Durmalon
Z	Black Zinc Nickel
G	Green Zinc Nickel
B	Black Electroless Nickel

4. ALTERNATE KEYING POSITION

Key Position	AB°	AC°
N	120	210
A	150	210
B	95	210
C	120	275
D	150	275

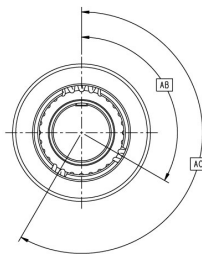

9 Pin Pig Tail Cable Assemblies

How to Order

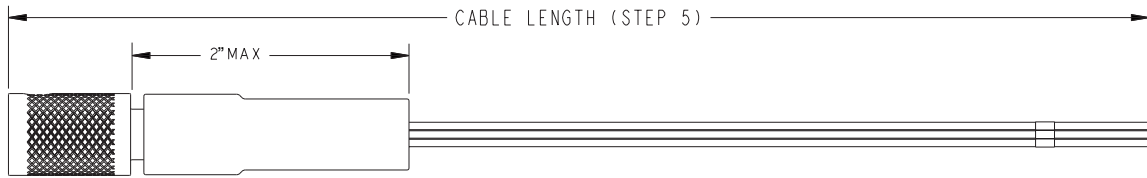

1.	2.	3.	4.	5.	6.
Series	Cable End A	Service Class	Alternate Keying Position (Side A)	Cable Length in Inches	Cable End B
MRC9	1	C	N	24	P

TEMPERATURE
-55° C to 105° C

1. SERIES	
MRC9	9 Pin MRC Connector

5. CABLE LENGTH	
Determine the overall length of your cable from end to end in inches. For Ex. 24 = 24 Inches. Note: 12 inch Minimum	

2. SHELL STYLE	
Connector Designator	Cable End A
1	Push-pull Receptacle (Spring Contacts)
3	Twist-lock Receptacle (Spring Contacts)

6. SHELL STYLE	
Connector Designator	Cable End B
P	Pig Tail Wire
P1	Push-Pull Receptacle
P3	Twist-Lock Receptacle

3. SERVICE CLASS	
	Finish
C	OD Cadmium
E	Electroless Nickel
D	Durmalon
Z	Black Zinc Nickel
G	Green Zinc Nickel
B	Black Electroless Nickel

4. ALTERNATE KEYING POSITION		
Key Position	AB°	AC°
N	120	210
A	150	210
B	95	210
C	120	275
D	150	275

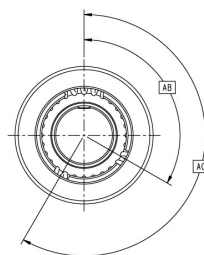

USB 2.0 / 3.0 Cable Assemblies

How to Order

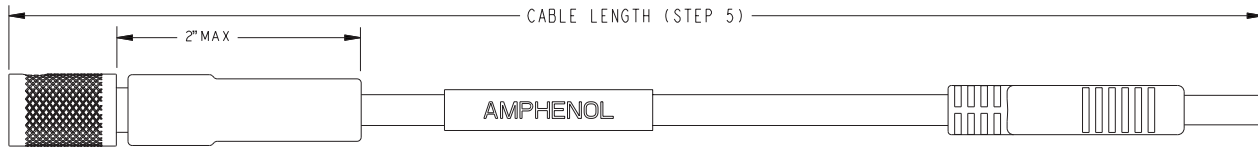

1.	2.	3.	4.	5.	6.
Series	Cable End A	Service Class	Alternate Keying Position (Side A)	Cable Length in Inches	Cable End B
MRC9	1	C	N	24	U1

1. SERIES

MRC9	9 Pin MRC Connector
-------------	---------------------

5. CABLE LENGTH

Determine the overall length of your cable from end to end in inches. For Ex. 24 = 24 Inches.
Note: 12 inch Minimum, 180 inch Maximum

2. SHELL STYLE

	Cable End A
1	Push-pull Receptacle (Spring Contacts)
3	Twist-lock Receptacle (Spring Contacts)

6. SHELL STYLE

	Cable End B	
U1	USB 2.0 Type A Male	
U2	USB 2.0 Type A Micro B Male	
U3	USB 3.0 Type A Male	
	U4 Superseded by U4A or U4B	
U4A*	USB 3.0 Type A Female	
U4B*	USB 3.0 Type A Female	
U5	USB 3.0 Type A Micro B Male	
U6A	Push-pull Receptacle	USB 2.0 Cable
U6B		USB 3.0 Cable
U7A	Twist-lock Receptacle	USB 2.0 Cable
U7B		USB 3.0 Cable

*See parent level drawing for wiring configuration

3. SERVICE CLASS

	Finish
C	OD Cadmium
E	Electroless Nickel
D	Durmalon
Z	Black Zinc Nickel
G	Green Zinc Nickel
B	Black Electroless Nickel

4. ALTERNATE KEYING POSITION (SIDE A)

Key Position	AB°	AC°
N	120	210
A	150	210
B	95	210
C	120	275
D	150	275

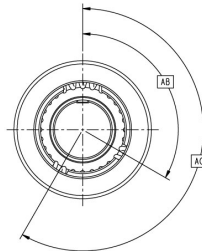

19 Pin HDMI Chassis Mount Plug

How to Order

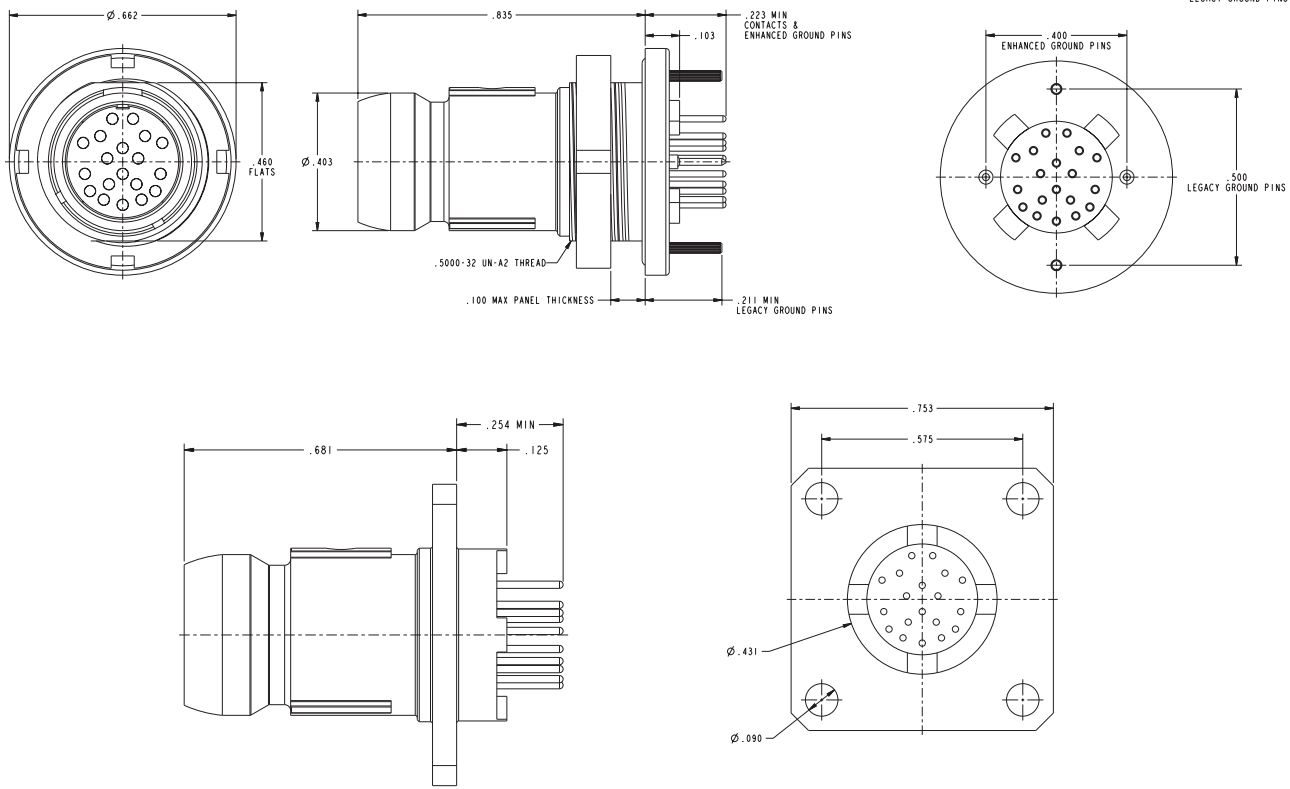

1.	2.	3.	4.	5.
Series	Shell Style	Service Class	Alternate Keying Position	Grounding Pins
MRC19	7	C	N	G

*Omit grounding pins for square flange.

1. SERIES	
MRC19	19 Pin MRC Connector

2. SHELL STYLE	
7	PC Jam Nut Panel Mount Plug

3. SERVICE CLASS	
	Finish
C	OD Cadmium
E	Electroless Nickel
D	Durmalon
Z	Black Zinc Nickel
G	Green Zinc Nickel
B	Black Electroless Nickel

4. ALTERNATE KEYING POSITION		
Key Position	AB°	AC°
N	120	210
A	150	210
B	95	210
C	120	275
D	150	275

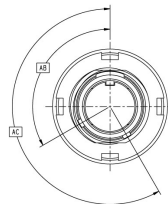

5. GROUNDING PINS	
Omit	Legacy Ground Pins - inactive for new design
G	Enhanced Ground Pins
N	Non-grounded

FOR JAMNUT ONLY

TEMPERATURE
-55° C to 175° C

SPANNER NUT TOOL
11-013020-007

30-40 inch lb. recommended torque

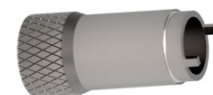

HDMI Cable Assemblies

How to Order

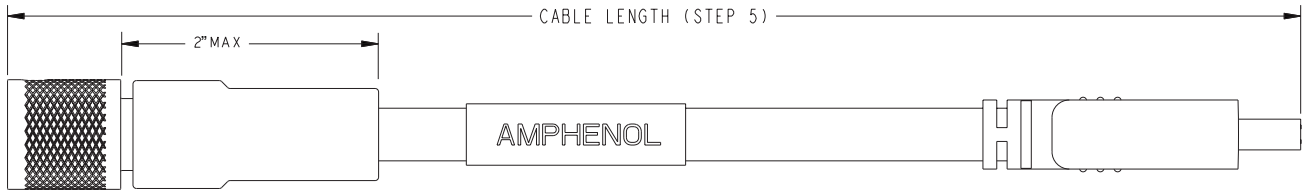

1.	2.	3.	4.	5.	6.
Series	Cable End A	Service Class	Alternate Keying Position (End A)	Cable Length in Inches	Cable End B
MRC19	1	C	N	24	H1

TEMPERATURE
-20° C to 80° C

1. SERIES

MRC19 19 Pin MRC Connector

2. SHELL STYLE

	Cable End A
1	Push-pull Receptacle (Spring Contacts)
3	Twist-lock Receptacle (Spring Contacts)

3. SERVICE CLASS

	Finish
C	OD Cadmium
E	Electroless Nickel
D	Durmalon
Z	Black Zinc Nickel
G	Green Zinc Nickel
B	Black Electroless Nickel

4. ALTERNATE KEYING POSITION (END A)

Key Position	AB°	AC°
N	120	210
A	150	210
B	95	210
C	120	275
D	150	275

5. CABLE LENGTH

Determine the overall length of your cable from end to end in inches. For Ex. 24 = 24 Inches.
Note: 12 inch Minimum, 180 inch Maximum.

6. SHELL STYLE

	Cable End B
H1	HDMI Male
H2	HDMI Male Mini
H3	Push-pull Receptacle (Spring Contacts)
H4	Twist-lock Receptacle (Spring Contacts)

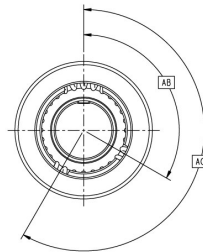

19 Pin Pig Tail Cable Assemblies

How to Order

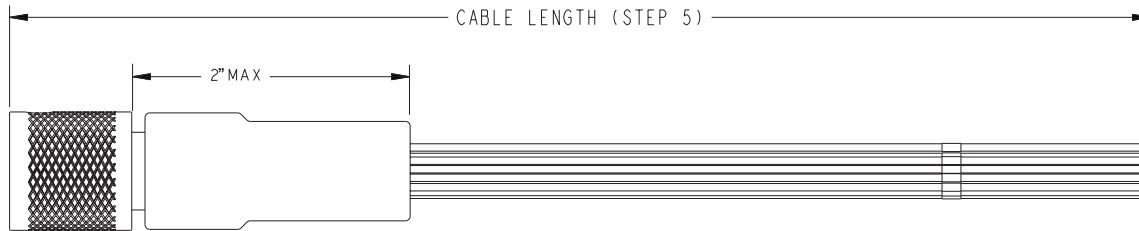

1.	2.	3.	4.	5.	6.	TEMPERATURE
Series	Cable End A	Service Class	Alternate Keying Position (End A)	Cable Length in Inches	Cable End B	
MRC19	1	C	N	24	P	-55° C to 105° C

1. SERIES	
MRC19	19 Pin MRC Connector

5. CABLE LENGTH
Determine the overall length of your cable from end to end in inches. For Ex. 24 = 24 Inches.
Note: 12 inch Minimum

2. SHELL STYLE	
	Cable End A
1	Push-pull Receptacle (Spring Contacts)
3	Twist-lock Receptacle (Spring Contacts)

6. SHELL STYLE	
Connector Designator	Cable End B
P	Pig Tail Wire
P1	Push-Pull Receptacle
P3	Twist-Lock Receptacle

3. SERVICE CLASS	
	Finish
C	OD Cadmium
E	Electroless Nickel
D	Durmalon
Z	Black Zinc Nickel
G	Green Zinc Nickel
B	Black Electroless Nickel

4. ALTERNATE KEYING POSITION (END A)		
Key Position	AB°	AC°
N	120	210
A	150	210
B	95	210
C	120	275
D	150	275

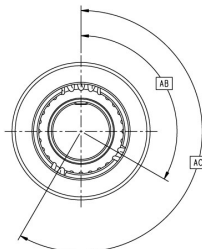

MRC - Protection Cap for Plug

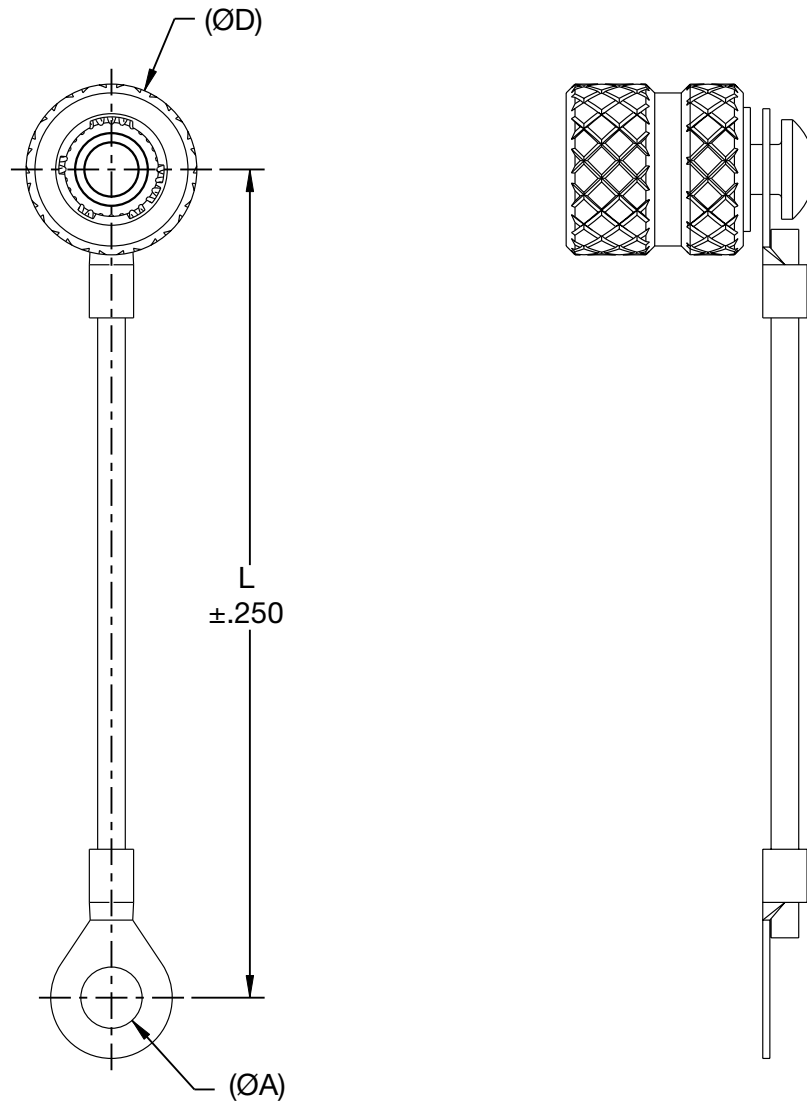

1 - PUSH-PULL RECEPTACLE (SPRING LOADED CONTACTS)

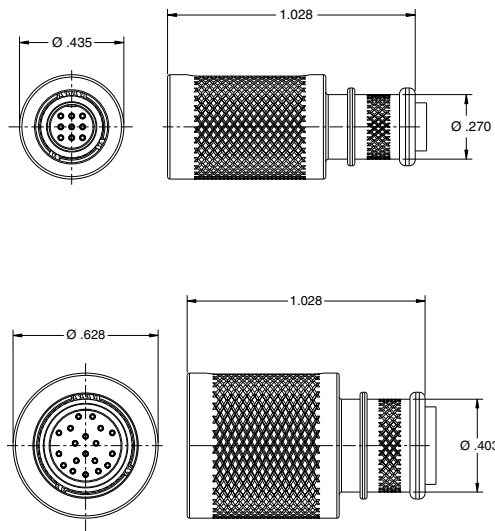

3 - TWIST-LOCK RECEPTACLE (SPRING LOADED CONTACTS)

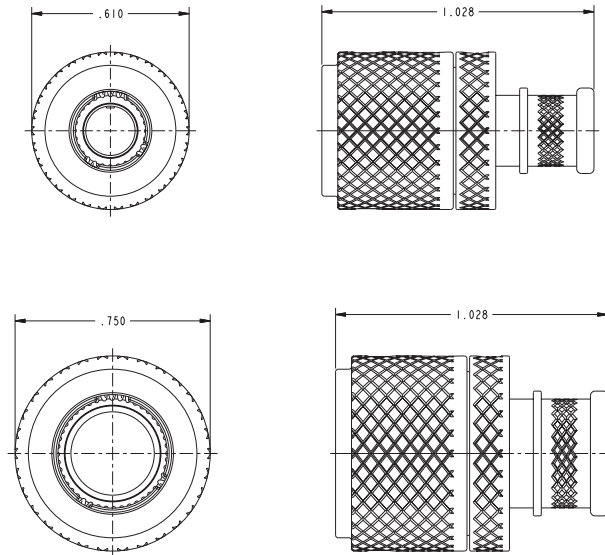

MRC SOLUTIONS

The MRC panel mount connectors are also available with COTS connector assemblies. These assemblies allow the user to connect commercial cables inside their box or on the backside of a bulkhead. This type of assembly allows the user to ruggedize specific areas of the application while others can remain commercial. Please contact Amphenol with your requirements.



High-Speed/High Frequency Contact Design Form

For Connectors and Cables

The following check list is provided to help you specify a high frequency contact and cable system, and it will help our design team to meet your requirements. You may copy this page and fax it to Amphenol Aerospace 607-563-5157, attention Contact Design. Or call 607-563-5011 or 800-678-0141 for assistance.

Date _____

Amphenol _____

Salesperson _____

CUSTOMER INFORMATION

Customer Company Name _____

Engineer Name _____

Program _____

Forecast _____

CABLE INFORMATION

Cable Part Number* _____

Cable Manufacturer _____

Cable Type: Coaxial Twinax Triax Quadrax

Cable Impedance _____

CONNECTOR INFORMATION

Connector Family: TV-R LJT-R JT-R

Other _____

Insert Arrangement Desired _____

Shell Style _____

Shell Plating _____

CONTACT INFORMATION

Type: Coaxial Concentric Twinax Triax

Differential Twinax* Quadrax*

Size*: 8 12 16

Contact Impedance Matched? Yes No

50 Ohm 75 Ohm 100 Ohm 150 Ohm

Other _____

* Quadrax and Differential Twinax currently available in size 8 only.

* if not an RG-Number complete below information:

O.D. of Inner Wire _____ AWG of Inner Wires _____

No. of Inner Wire Strands _____ Material of Inner Wires _____

O.D. of Inner Insulation _____ Material of Inner Insulation _____

O.D. of First Braid _____ Braid Type _____ Braid AWG _____
(flat, round, wrap)

O.D. of First Jacket _____ Jacket Material _____

O.D. of Second Braid _____ Braid Type _____ Braid AWG _____
(flat, round, wrap)

O.D. of Second Jacket _____ Jacket Material _____

It is essential that a 3 foot sample of the cable be supplied for performance and crimp tool development.

PERFORMANCE INFORMATION

Electrical Protocol _____

VSWR Requirement 1. to 1. _____ Cross Talk _____ db

Operating Frequency _____ Attenuation _____ Insertion Loss _____

Operating Voltage _____ VAC (RMS) _____ DC

Current Outer Contact _____ Amp Current Inner Contacts _____ Amp

Application Temperature _____ Environmental Requirement _____

Компания «Life Electronics» занимается поставками электронных компонентов импортного и отечественного производства от производителей и со складов крупных дистрибьюторов Европы, Америки и Азии.

С конца 2013 года компания активно расширяет линейку поставок компонентов по направлению коаксиальный кабель, кварцевые генераторы и конденсаторы (керамические, пленочные, электролитические), за счёт заключения дистрибьюторских договоров

Мы предлагаем:

- Конкурентоспособные цены и скидки постоянным клиентам.
- Специальные условия для постоянных клиентов.
- Подбор аналогов.
- Поставку компонентов в любых объемах, удовлетворяющих вашим потребностям.
- Приемлемые сроки поставки, возможна ускоренная поставка.
- Доставку товара в любую точку России и стран СНГ.
- Комплексную поставку.
- Работу по проектам и поставку образцов.
- Формирование склада под заказчика.
- Сертификаты соответствия на поставляемую продукцию (по желанию клиента).
- Тестирование поставляемой продукции.
- Поставку компонентов, требующих военную и космическую приемку.
- Входной контроль качества.
- Наличие сертификата ISO.

В составе нашей компании организован Конструкторский отдел, призванный помогать разработчикам, и инженерам.

Конструкторский отдел помогает осуществить:

- Регистрацию проекта у производителя компонентов.
- Техническую поддержку проекта.
- Защиту от снятия компонента с производства.
- Оценку стоимости проекта по компонентам.
- Изготовление тестовой платы монтаж и пусконаладочные работы.



Тел: +7 (812) 336 43 04 (многоканальный)

Email: org@lifeelectronics.ru