

**AUTOMOTIVE COMPLIANT 60V Two Terminal Constant Current LED Driver PowerDI**

NEW PRODUCT

**Description**

The AL5809Q is a constant current linear LED driver that provides a cost-effective two-pin solution to LED driving. It has an excellent temperature stability of 20ppm/°C with tight ±5% current accuracy over a wide voltage and temperature range. The AL5809Q comes in various fixed output current versions removing the need for external current setting resistors creating a simple solution for the linear driving of LEDs. It supports both the high-side and low-side driving of LED chains.

The AL5809Q turns on immediately and operates with a voltage across its terminals varying from 2.5V up to 60V, enabling it to drive long LED chains. The maximum 60V voltage rating between input and output pins enables it to withstand high peak transient voltages that can occur in automotive applications.

The AL5809Q is available in the thermally robust PowerDI<sup>®</sup>123 (Type B) package. The AL5809Q has been qualified to AEC-Q100 Grade 3 and is Automotive Compliant supporting PPAPs.

**Features**

- Robust Power Dissipation Up to 1.5W for PowerDI123 (Type B)
- -40°C to +150°C Junction Temperature Range
- ±5% LED Current Tolerance Overtemperature and  $V_{INOUT}$
- Large Number of Output Current Options:
  - 15mA, 20mA, 25mA, 30mA, 40mA, 50mA, 60mA, 90mA, 100mA, 120mA, and 150mA Available in PowerDI123 (Type B) Package
- 2.5V to 60V Operating Voltage Between Two Terminals
- Automotive Compliant
- **Totally Lead-Free & Fully RoHS Compliant (Notes 1 & 2)**
- **Halogen and Antimony Free. "Green" Device (Note 3)**
- **Qualified to AEC-Q100 Grade 3 and TS16949 Certification**
- **PPAP Capable (Note 4)**

- Notes:
1. No purposely added lead. Fully EU Directive 2002/95/EC (RoHS) & 2011/65/EU (RoHS 2) compliant.
  2. See [http://www.diodes.com/quality/lead\\_free.html](http://www.diodes.com/quality/lead_free.html) for more information about Diodes Incorporated's definitions of Halogen- and Antimony-free, "Green" and Lead-free.
  3. Halogen- and Antimony-free "Green" products are defined as those which contain <900ppm bromine, <900ppm chlorine (<1500ppm total Br + Cl) and <1000ppm antimony compounds.
  4. Automotive products are AEC-Q100 qualified and are PPAP capable. Refer to [http://www.diodes.com/quality/product\\_compliance\\_definitions/](http://www.diodes.com/quality/product_compliance_definitions/).

**Pin Assignments**



**Applications**

- Automotive Interior Lamps
- Automotive Parking Lights
- Instrumentation Illumination

**Typical Applications Circuit**



### Pin Descriptions

Pin Name	Pin Number (PowerDI123 (Type B))	Function
In	1	LED Current Input Terminal Current flows <b>IN</b> to this pin. For low-side LED string application, connect the LED cathode terminal to the "In" terminal. For high-side LED string application, connect the LED anode terminal to the "Out" terminal.
Out	2	LED Current Output Terminal Current flows <b>OUT</b> of this pin. For low-side LED string application, connect the LED anode terminal to the "Out" terminal. For high-side LED string application, connect the LED cathode terminal to the "Out" terminal.

### Functional Block Diagram

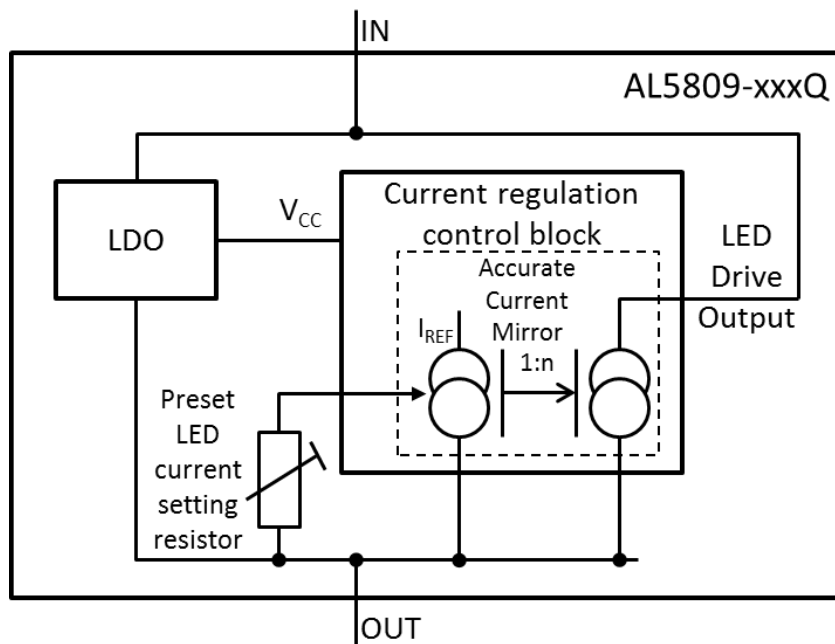

### Absolute Maximum Ratings

Symbol	Parameters	Ratings	Unit
$V_{INOUT}$	"In" Voltage Relative to "Out" Pin	80	V
$I_{INOUT}$	LED Current from "In" to "Out"	180	mA
ESD HBM	Human Body Model ESD Protection	4	kV
ESD MM	Machine Model ESD Protection	400	V
$T_J$	Operating Junction Temperature	-40 to +175	°C
$T_{ST}$	Storage Temperature	-55 to +150	°C

Caution: Stresses greater than the 'Absolute Maximum Ratings' specified above, may cause permanent damage to the device. These are stress ratings only; functional operation of the device at these or any other conditions exceeding those indicated in this specification is not implied. Device reliability may be affected by exposure to absolute maximum rating conditions for extended periods of time. Semiconductor devices are ESD sensitive and may be damaged by exposure to ESD events. Suitable ESD precautions should be taken when handling and transporting these devices.

### Package Thermal Data

Package	$\theta_{JC}$ Thermal Resistance Junction-to-Case	$\theta_{JA}$ Thermal Resistance Junction-to-Ambient	$P_{DIS}$ $T_A = +25^\circ C, T_J = +150^\circ C$
PowerDI123 (Type B)	27.15°C/W	148.6°C/W (Note 5)	0.84W
PowerDI123 (Type B)	17.81°C/W	81.4°C/W (Note 6)	1.53W

### Recommended Operating Conditions (@ $T_A = +25^\circ C$ , unless otherwise specified.)

Symbol	Parameter	Min	Max	Unit
$V_{INOUT}$	"In" Voltage Range Relative to "Out" Pin	2.5	60	V
$I_{INOUT}$	LED Current (Note 7)	15	150	mA
$T_J$	Operating Junction Temperature Range (Note 8)	-40	+150	°C
$T_A$	Operating Ambient Temperature Range (Note 8)	-40	+85	°C

### Electrical Characteristics ( $V_{INOUT} = 3.5V$ ) (@ $T_A = +25^\circ C$ , unless otherwise specified.) (Note 9)

Symbol	Parameter	Conditions	Min	Typ	Max	Unit
$V_{INOUT}$	In-Out Supply Voltage	— $T_J = -40^\circ C$ to $+150^\circ C$	2.5	—	60	V
$I_{INOUT}$	$I_{INOUT}$ Current Accuracy ( $\pm 5\%$ for Overtemperature)	AL5809-15QP1-7 $T_J = -40^\circ C$ to $+150^\circ C$	14.25	15	15.75	mA
		AL5809-20QP1-7 $T_J = -40^\circ C$ to $+150^\circ C$	19	20	21	
		AL5809-25QP1-7 $T_J = -40^\circ C$ to $+150^\circ C$	23.75	25	26.25	
		AL5809-30QP1-7 $T_J = -40^\circ C$ to $+150^\circ C$	28.5	30	31.5	
		AL5809-40QP1-7 $T_J = -40^\circ C$ to $+150^\circ C$	38	40	42	
		AL5809-50QP1-7 $T_J = -40^\circ C$ to $+150^\circ C$	47.5	50	52.5	
		AL5809-60QP1-7 $T_J = -40^\circ C$ to $+150^\circ C$	57	60	63	
		AL5809-90QP1-7 $T_J = -40^\circ C$ to $+150^\circ C$	85.5	90	94.5	
		AL5809-100QP1-7 $T_J = -40^\circ C$ to $+150^\circ C$	95	100	105	
		AL5809-120QP1-7 $T_J = -40^\circ C$ to $+150^\circ C$	114	120	126	
AL5809-150QP1-7 $T_J = -40^\circ C$ to $+150^\circ C$	142.5	150	157.5			
$I_{LINE}$	$I_{INOUT}$ Current Line Regulation	$V_{INOUT} = 2.5V$ to $60V$ (Note 10) $T_A = +25^\circ C$	—	1	—	%/V
$V_{MIN}$	Minimum Power Up Voltage	Increase $V_{INOUT}$ (Note 11) $T_J = -40^\circ C$ to $+150^\circ C$	1	1.5	2	V
$T_{SHDN}$	Thermal Shutdown Junction Temperature	—	—	+165	—	°C
$T_{HYS}$	Thermal Shutdown Hysteresis	—	—	+30	—	°C

- Notes:
5. Test condition for PowerDI123 (Type B): Device mounted on 25.4mm x 25.4mm FR-4 PCB (10mm x 10mm 1oz copper, minimum recommended pad layout on top layer and thermal vias to bottom layer ground plane). For better thermal performance, larger copper pad for heatsink is needed.
  6. When mounted on 50.8mm x 50.8mm GETEK PCB with 25.4mm x 25.4mm copper pads.
  7. The LED operating current is determined by the AL5809Q current option index XXX, AL5809Q-XXXP1-7.
  8. The Maximum ambient temperature range is limited by device power dissipation; such that its junction temperature should be kept less than or equal to +150°C. See Page 5 for more information on power dissipation. Devices have been qualified to AEC-Q100 Grade 3.
  9. All voltages unless otherwise stated are measured with respect to the Out Pin.
  10. Measured percentage change of LED current variation when  $V_{INOUT}$  varies from 2.5V to 60V for each current option.
  11. Apply the power linearly to the chip until the device starts to turn on.

## Application Information

### Description

The AL5809Q is a constant current linear LED driver that can be connected on the high side or low side of the LEDs as a Constant Current Regulator (CCR). The AL5809Q is available in various output current options from 15mA up to 150mA.

The AL5809Q contains a Low Dropout regulator which provides power to the internal current regulation control block. A fixed preset LED current setting resistor sets the reference current of the current regulation block. The LED current setting resistor varies with each variant of the AL5809. An accurate current mirror within the current regulation control block then increases the reference current to the preset LED current of the AL5809Q.

### Simple LED String

The number of LEDs that the AL5809Q can drive depends on the forward voltage drop of the LEDs and the input supply voltage (minus the minimum operating voltage of the AL5809Q). The designer needs to calculate the maximum voltage between In and Out by taking into account the maximum input voltage less the voltage across the LED string (Figures 1 & 2).



**Figure 1 Low-Side LED String Drive**

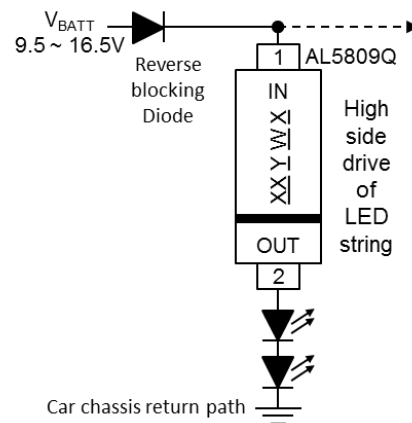

**Figure 2 High-Side LED String Drive**

The AL5809Q can also be used on the high-side of the LEDs (See Figure 2). The minimum system input voltage can be calculated by:

$$V_{IN(MIN)} = V_{LED\_CHAIN} + 2.5V \quad \text{Where } V_{LED\_CHAIN} \text{ is the LED chain voltage and } 2.5V \text{ is the minimum } V_{IO(OUT)} \text{ voltage of the AL5809Q.}$$

The LED current can be increased by connecting two or more AL5809Q in parallel shown in Figure 3.



**(a) Low-Side Configuration**



**(b) High-Side Configuration**

**Figure 3 Higher LED Current by Parallel Configuration of AL5809Q**

**Application Information** (Continued)

**Power Dissipation**

The maximum ambient temperature range of the AL5809Q is determined by its power dissipation and thermal impedance of the PCB onto which it is mounted. Its junction temperature must be kept equal to or less than +150°C.

The power dissipated is determined by the LED current version that has been selected (15, 20, 25 30, 40, 50, 60, 90, 100, 120 or 150mA) and the difference between the input voltage and LED chain voltage.

$$V_{INOUT} * I_{LED}$$

In automotive applications the typical input voltage will be around 13V but can vary between 9V (without stop-start operation) and approximately 16V.

The recommended minimum  $V_{INOUT}$  voltage of 2.5V enables the AL5809Q to drive 2 LED in series from the 9V battery voltage (assuming  $V_{LED} < 3.25V$ ).

The AL5809Q's power dissipation under these conditions will be:

$$V_{INOUT} * I_{LED} = 2.5 * I_{LED}$$

So for the 20mA AL5809-20QPI under these conditions this equals:

$$2.5V * 20mA = 50mW$$

Under maximum input conditions (16V) the AL5809Q's power dissipation will be:

$$V_{INOUT} * I_{LED} = 9.5 * I_{LED}$$

So for the 20mA AL5809-20QPI this equals:

$$9.5V * 20mA = 190mW$$

So there is a large difference in power dissipation of the Linear LED driver between minimum and maximum battery voltages. And care must be taken to calculate expected power dissipations and then determining the suitable PCB material and layout. See Figures 4 and 5 for graphs showing power dissipation and maximum  $V_{INOUT}$ , for different currents and PCB material. Maximizing the area and mass of the ground plane and additional vias between the pad of the Out Pin will improve the thermal impedance ( $\theta_{JA}$ ) of the AL5809Q.



**Figure 4 Power Dissipation vs. Ambient Temperature @  $T_j = +150^\circ C$**



**Figure 5 Maximum  $V_{INOUT}$  vs. Ambient Temperature @  $T_j = +150^\circ C$**

**Application Information** (Cont.)

**PWM Dimming**

The AL5809Q can be used to provide LED current dimming driving the Out Pin via an external MOSFET switch to Ground (Figure 6a) for high-side connected LEDs or a high-side switch for Ground-connected LEDs. The Out Pin current is then effectively switched on and off causing the LED current to turn on and off.

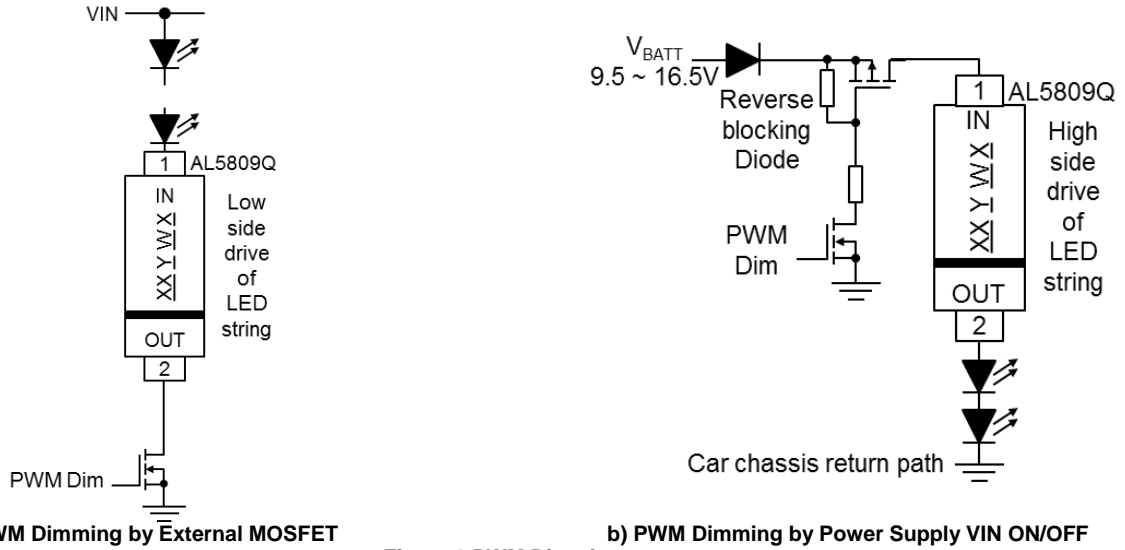

Figure 6 PWM Dimming

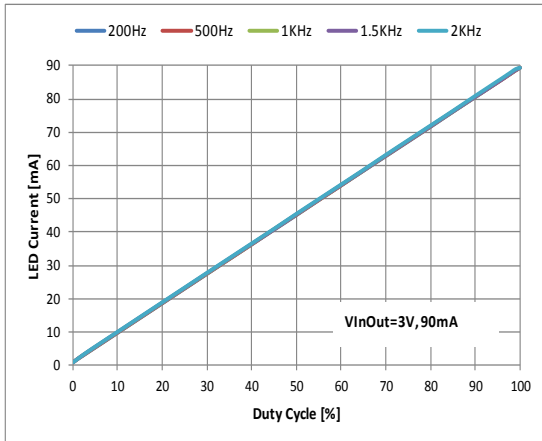

Figure 7 PWM Dimming 90mA vs. Duty Cycle

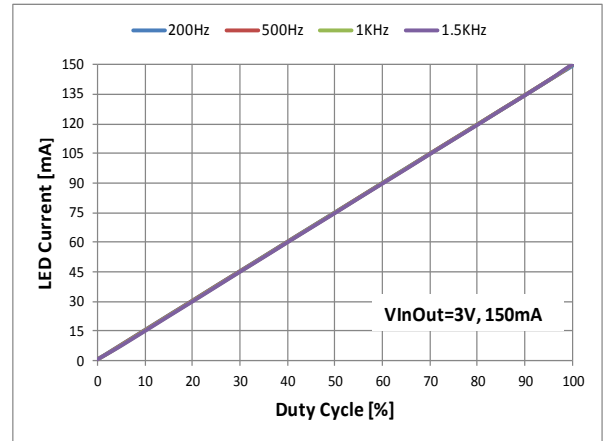

Figure 8 PWM Dimming 150mA vs. Duty Cycle

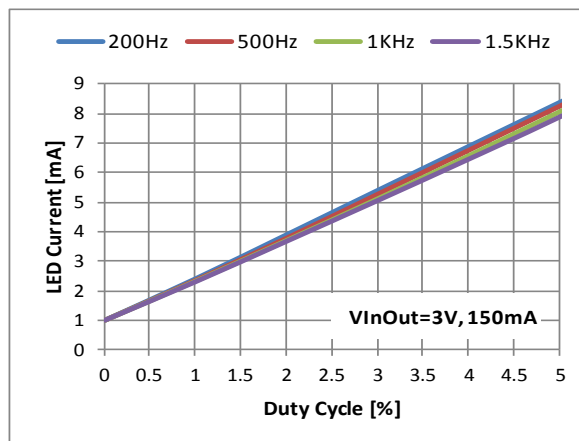

Figure 9 Zoomed-In with Duty Cycle ≤5% of Figure 8

**Typical Performance Characteristics** (15mA, 20mA, 30mA, 40mA, 50mA Options)

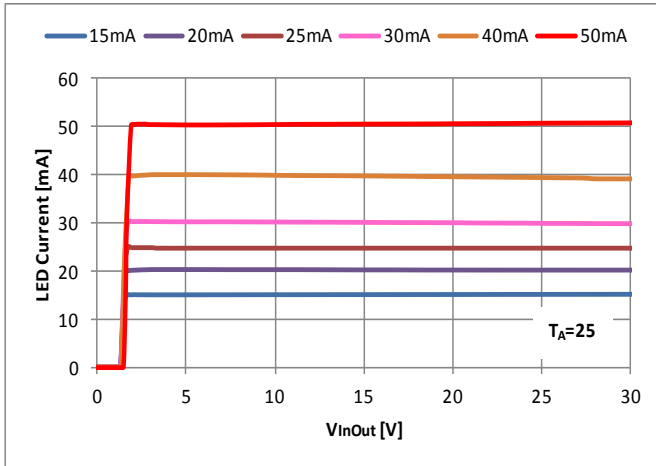

Figure 10 LED Current vs.  $V_{INOUT}$

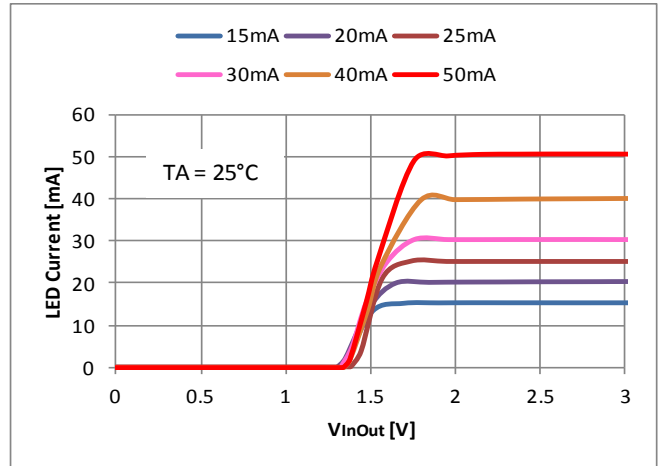

Figure 11 Startup Minimum Operating Voltage

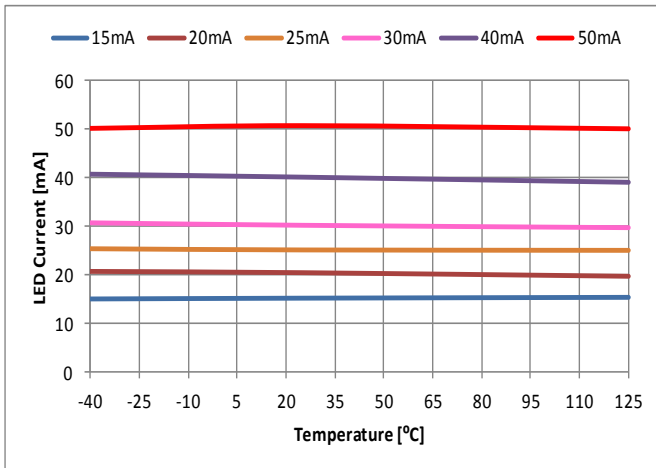

Figure 12 LED Current vs. Ambient Temperature

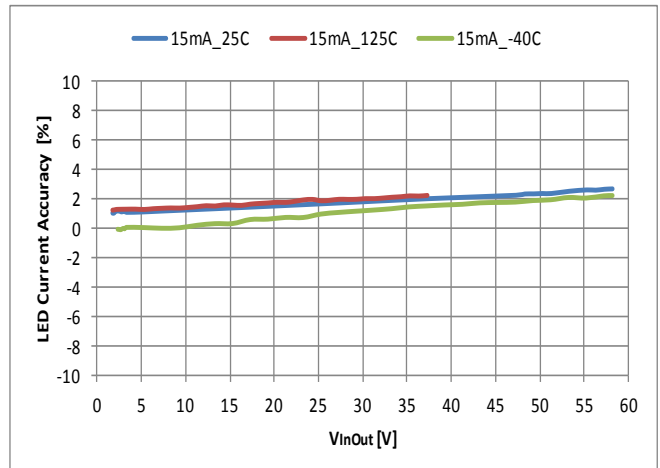

Figure 13 LED Current Accuracy (%) vs.  $V_{INOUT}$  Across Temperature

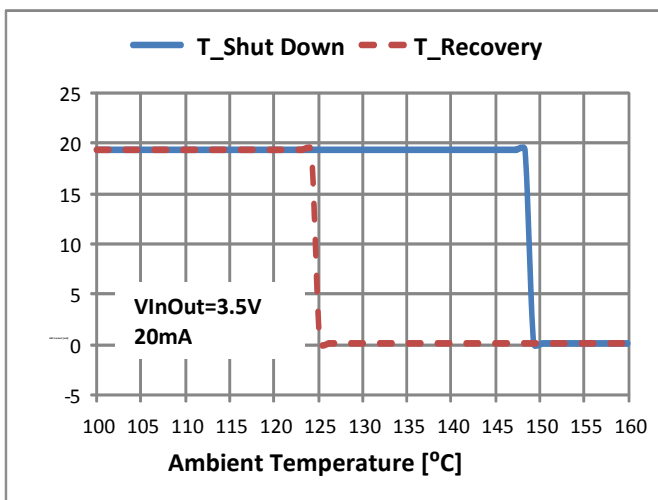

Figure 14 THSD of 20mA Current Option



Figure 15 THSD of 40mA Current Option

**Typical Performance Characteristics** (Continued) (60mA, 90mA, 150mA Options)



Figure 16 LED Current vs. VInOut



Figure 17 Startup Minimum Operating Voltage



Figure 18 LED Current across Temperature



Figure 19 LED Current Accuracy (%) vs. VInOut across Temperature



Figure 20 THSD of 60mA Current Option



Figure 21 THSD of 150mA Current Option



**Ordering Information** (Note 12)



Part Number	LED Current Option	Package Code	Packaging	7" Tape and Reel		Qualification (Note 13)
				Quantity	Part Number Suffix	
AL5809-15QP1-7	15mA	P1	PowerDI123 (Type B)	3,000	-7	Automotive Compliant
AL5809-20QP1-7	20mA	P1	PowerDI123 (Type B)	3,000	-7	Automotive Compliant
AL5809-25QP1-7	25mA	P1	PowerDI123 (Type B)	3,000	-7	Automotive Compliant
AL5809-30QP1-7	30mA	P1	PowerDI123 (Type B)	3,000	-7	Automotive Compliant
AL5809-40QP1-7	40mA	P1	PowerDI123 (Type B)	3,000	-7	Automotive Compliant
AL5809-50QP1-7	50mA	P1	PowerDI123 (Type B)	3,000	-7	Automotive Compliant
AL5809-60QP1-7	60mA	P1	PowerDI123 (Type B)	3,000	-7	Automotive Compliant
AL5809-90QP1-7	90mA	P1	PowerDI123 (Type B)	3,000	-7	Automotive Compliant
AL5809-100QP1-7	100mA	P1	PowerDI123 (Type B)	3,000	-7	Automotive Compliant
AL5809-120QP1-7	120mA	P1	PowerDI123 (Type B)	3,000	-7	Automotive Compliant
AL5809-150QP1-7	150mA	P1	PowerDI123 (Type B)	3,000	-7	Automotive Compliant

Notes: 12. For packaging details, go to our website at <http://www.diodes.com/products/packages.html>.  
 13. AL5809Q has been qualified to AEC-Q100 grade 3 and is classified as "Automotive Compliant" supporting PPAP documentation. See AL5809 datasheet for commercial qualified versions.

**Marking Information**

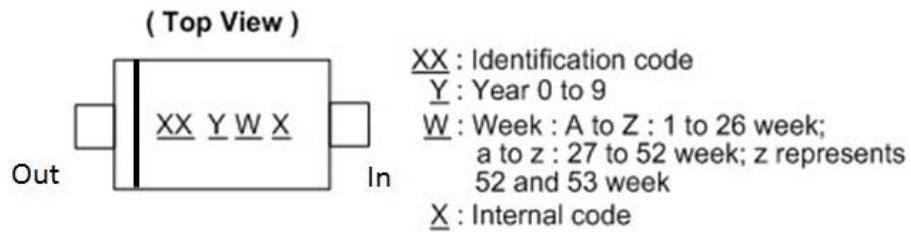

Part Number	Package	Identification Code
AL5809-15QP1-7	PowerDI123 (Type B)	C1
AL5809-20QP1-7	PowerDI123 (Type B)	C2
AL5809-25QP1-7	PowerDI123 (Type B)	CA
AL5809-30QP1-7	PowerDI123 (Type B)	C3
AL5809-40QP1-7	PowerDI123 (Type B)	C4
AL5809-50QP1-7	PowerDI123 (Type B)	C5
AL5809-60QP1-7	PowerDI123 (Type B)	C6
AL5809-90QP1-7	PowerDI123 (Type B)	C7
AL5809-100QP1-7	PowerDI123 (Type B)	CB
AL5809-120QP1-7	PowerDI123 (Type B)	C8
AL5809-150QP1-7	PowerDI123 (Type B)	C9

## Package Outline Dimensions

Please see AP02001 at [http://www.diodes.com/\\_files/datasheets/ap02001.pdf](http://www.diodes.com/_files/datasheets/ap02001.pdf) for the latest version.

PowerDI123 (Type B)



PowerDI123 (Type B)			
Dim	Min	Max	Typ
A	3.50	3.90	3.70
B	2.60	3.00	2.80
C	1.63	1.93	1.78
D	0.93	1.00	0.98
E	0.85	1.25	1.00
H	0.15	0.25	0.20
L	0.50	0.80	0.65
All Dimensions in mm			

## Suggested Pad Layout

Please see AP02001 at [http://www.diodes.com/\\_files/datasheets/ap02001.pdf](http://www.diodes.com/_files/datasheets/ap02001.pdf) for the latest version.

PowerDI123 (Type B)

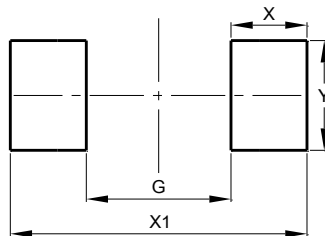

Dimensions	Value (in mm)
G	2.000
X	1.050
X1	4.100
Y	1.500

## Taping Orientation

The taping orientation of the other package type can be found on our website at [http://www.diodes.com/\\_files/datasheets/ap02007.pdf](http://www.diodes.com/_files/datasheets/ap02007.pdf).

PowerDI123 (Type B)

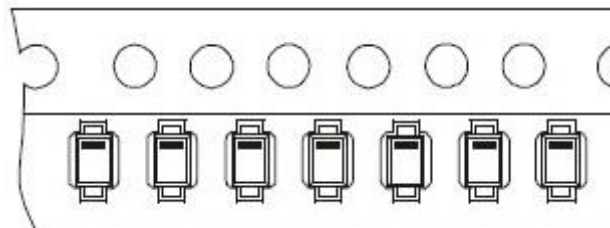

**IMPORTANT NOTICE**

DIODES INCORPORATED MAKES NO WARRANTY OF ANY KIND, EXPRESS OR IMPLIED, WITH REGARDS TO THIS DOCUMENT, INCLUDING, BUT NOT LIMITED TO, THE IMPLIED WARRANTIES OF MERCHANTABILITY AND FITNESS FOR A PARTICULAR PURPOSE (AND THEIR EQUIVALENTS UNDER THE LAWS OF ANY JURISDICTION).

Diodes Incorporated and its subsidiaries reserve the right to make modifications, enhancements, improvements, corrections or other changes without further notice to this document and any product described herein. Diodes Incorporated does not assume any liability arising out of the application or use of this document or any product described herein; neither does Diodes Incorporated convey any license under its patent or trademark rights, nor the rights of others. Any Customer or user of this document or products described herein in such applications shall assume all risks of such use and will agree to hold Diodes Incorporated and all the companies whose products are represented on Diodes Incorporated website, harmless against all damages.

Diodes Incorporated does not warrant or accept any liability whatsoever in respect of any products purchased through unauthorized sales channel. Should Customers purchase or use Diodes Incorporated products for any unintended or unauthorized application, Customers shall indemnify and hold Diodes Incorporated and its representatives harmless against all claims, damages, expenses, and attorney fees arising out of, directly or indirectly, any claim of personal injury or death associated with such unintended or unauthorized application.

Products described herein may be covered by one or more United States, international or foreign patents pending. Product names and markings noted herein may also be covered by one or more United States, international or foreign trademarks.

This document is written in English but may be translated into multiple languages for reference. Only the English version of this document is the final and determinative format released by Diodes Incorporated.

**LIFE SUPPORT**

Diodes Incorporated products are specifically not authorized for use as critical components in life support devices or systems without the express written approval of the Chief Executive Officer of Diodes Incorporated. As used herein:

A. Life support devices or systems are devices or systems which:

1. are intended to implant into the body, or
2. support or sustain life and whose failure to perform when properly used in accordance with instructions for use provided in the labeling can be reasonably expected to result in significant injury to the user.

B. A critical component is any component in a life support device or system whose failure to perform can be reasonably expected to cause the failure of the life support device or to affect its safety or effectiveness.

Customers represent that they have all necessary expertise in the safety and regulatory ramifications of their life support devices or systems, and acknowledge and agree that they are solely responsible for all legal, regulatory and safety-related requirements concerning their products and any use of Diodes Incorporated products in such safety-critical, life support devices or systems, notwithstanding any devices- or systems-related information or support that may be provided by Diodes Incorporated. Further, Customers must fully indemnify Diodes Incorporated and its representatives against any damages arising out of the use of Diodes Incorporated products in such safety-critical, life support devices or systems.

Copyright © 2016, Diodes Incorporated

[www.diodes.com](http://www.diodes.com)

Компания «Life Electronics» занимается поставками электронных компонентов импортного и отечественного производства от производителей и со складов крупных дистрибьюторов Европы, Америки и Азии.

С конца 2013 года компания активно расширяет линейку поставок компонентов по направлению коаксиальный кабель, кварцевые генераторы и конденсаторы (керамические, пленочные, электролитические), за счёт заключения дистрибьюторских договоров

Мы предлагаем:

- Конкурентоспособные цены и скидки постоянным клиентам.
- Специальные условия для постоянных клиентов.
- Подбор аналогов.
- Поставку компонентов в любых объемах, удовлетворяющих вашим потребностям.
- Приемлемые сроки поставки, возможна ускоренная поставка.
- Доставку товара в любую точку России и стран СНГ.
- Комплексную поставку.
- Работу по проектам и поставку образцов.
- Формирование склада под заказчика.
- Сертификаты соответствия на поставляемую продукцию (по желанию клиента).
- Тестирование поставляемой продукции.
- Поставку компонентов, требующих военную и космическую приемку.
- Входной контроль качества.
- Наличие сертификата ISO.

В составе нашей компании организован Конструкторский отдел, призванный помогать разработчикам, и инженерам.

Конструкторский отдел помогает осуществить:

- Регистрацию проекта у производителя компонентов.
- Техническую поддержку проекта.
- Защиту от снятия компонента с производства.
- Оценку стоимости проекта по компонентам.
- Изготовление тестовой платы монтаж и пусконаладочные работы.



Тел: +7 (812) 336 43 04 (многоканальный)

Email: [org@lifeelectronics.ru](mailto:org@lifeelectronics.ru)