

T1/CEPT/ISDN-PRI TRANSFORMERS

Dual Surface Mount, 1500 Vrms, Extended and Standard Temperature Range



- Dual SMT package contains both transmit and receive transformers
- Models matched to leading transceiver ICs
- Isolation voltage: 1500 Vrms
- UL 1459 and UL 1950 recognized
- EN 60950 safety agency approval per BABT
- Lead-Free versions available upon request

Electrical Specifications @ 25°C

Part Number	Turns Ratio ^B (Pri:Sec ± 2%)	OCL @ 25°C (mH MIN)	L _L (μH MAX)	C _{w/w} (pF MAX)	DCR Pri (Ω MAX)	DCR Sec (Ω MAX)	Package/ Schematic	Primary Pins
EXTENDED TEMPERATURE RANGE MODELS¹ – OPERATING TEMPERATURE -40°C TO +85°C								
PE-68841	1CT:2CT & 1CT:2CT	1.20 & 1.20	0.80 & 0.80	50 & 50	1.00 & 1.00	1.70 & 1.70	AN/2	12-10, 4-6
PE-68822	1CT:2CT & 1:1.36CT	1.60 & 1.60	1.00 & 0.80	60 & 55	1.70 & 1.70	2.00 & 1.70	AN/1	12-10, 4-6
PE-68825	1:1.15CT & 1CT:2CT	1.60 & 1.60	0.80 & 0.80	60 & 50	1.00 & 1.00	1.20 & 2.00	AN/4	12-10, 4-6
PE-68826 ^E	1:1/1.26 & 1:2CT	1.20 & 1.20	0.80 & 0.80	50 & 60	1.00 & 1.00	1.10 & 1.70	AN/5	12-10, 4-6
PE-68827	1:1CT & 2:1	1.60 & 1.60	1.30 & 1.30	55 & 40	1.10 & 1.10	1.10 & 0.70	AN/6	1-3, 4-6
PE-68828	1CT:1CT & 1CT:1CT	1.20 & 1.20	0.80 & 0.80	50 & 50	1.00 & 1.00	1.00 & 1.00	AN/2	1-3, 4-6
PE-68874	1CT:1.15CT & 1CT:1.15CT	1.20 & 1.20	0.80 & 0.80	50 & 50	1.20 & 1.20	1.40 & 1.40	AN/2	1-3, 4-6
PE-68877	1CT:1CT & 1CT:2CT	1.20 & 1.20	0.80 & 0.80	50 & 50	1.00 & 1.00	1.00 & 1.80	AN/2	1-3, 4-6
PE-68882	1CT:1.15CT & 1CT:1CT	1.60 & 1.60	0.80 & 0.80	60 & 60	1.20 & 1.20	1.40 & 1.20	AN/2	12-10, 4-6
PE-68884	1CT:1.36CT & 1CT:1.36CT	1.20 & 1.20	0.80 & 0.80	50 & 50	1.20 & 1.20	1.40 & 1.40	AN/2	1-3, 4-6
PE-68887	1CT:1.41CT & 1CT:1.41CT	1.20 & 1.20	0.80 & 0.80	50 & 50	1.40 & 1.40	1.20 & 1.20	AN/2	12-10, 9-7
PE-68881	1CT:2.3CT & 1CT:2CT	1.20 & 1.20	0.80 & 0.80	60 & 50	1.20 & 1.20	2.10 & 2.10	AN/2	10-12, 4-6
TX1277	1CT:1CT & 1CT:2CT	1.20 & 1.20	0.80 & 0.80	50 & 50	1.00 & 1.00	1.00 & 1.80	AN/2	1-3, 4-6
STANDARD TEMPERATURE RANGE MODELS – OPERATING TEMPERATURE 0°C TO +70°C								
T1131 ¹	1CT:1 & 1:1.36CT	0.70 & 0.70	0.70 & 0.70	20 & 20	0.25 & 0.50	0.80 & 0.40	AN/7	1-3, 9-7
PE-68861	1CT:2CT & 1CT:2CT	1.20 & 1.20	0.60 & 0.60	35 & 35	0.70 & 0.70	1.20 & 1.20	AN/2	12-10, 4-6
PE-68862	1CT:2CT & 1:1.36CT	1.20 & 1.20	0.60 & 0.80	35 & 37	0.70 & 0.70	1.20 & 0.90	AN/1	12-10, 4-6
PE-68863	1:2CT & 1:1.14CT	1.20 & 1.20	0.55 & 0.80	40 & 35	0.70 & 0.70	1.20 & 0.90	AN/5	12-10, 4-6
PE-68864 ^A	1CT:2CT & 1:1	1.20 & 1.20	0.30-0.55 & 0.80	30 & 30	0.70 & 0.70	1.20 & 0.70	AN/3	1-3, 5-6
PE-68865	1:1.15CT & 1CT:2CT	1.50 & 1.20	0.80 & 0.60	35 & 35	0.70 & 0.70	0.90 & 1.20	AN/4	12-10, 4-6
PE-68866 ^E	1:1/1.26 & 1:2CT	1.50 & 1.20	0.40 & 0.50	40 & 40	0.70 & 0.70	0.90 & 1.20	AN/5	12-10, 4-6
PE-68869	1CT:2CT & 1:1.08CT	1.20 & 1.20	0.60 & 0.60	40 & 30	0.70 & 0.70	1.10 & 0.90	AN/1	12-10, 4-6
PE-68836 ^E	1:1/1.26 & 1:1/1.26	1.50 & 1.50	0.40 & 0.40	45 & 45	0.80 & 0.80	1.00 & 1.00	AN/7	12-10, 9-7

NOTE: For Quad Surface Mount packages, refer to data sheet T615. For Reinforced Insulation Models, refer to data sheet T617. For Octal Surface Mount package models, refer to data sheet T622. (See Pages 6 and 7 for Table Notes)

Mechanical

Schematics

SUGGESTED PAD LAYOUT

Weight 4.0 grams
Tape & Reel250/reel
Tube30/tube

Dimensions: Inches / mm
 Unless otherwise specified, all tolerances are ± .010 / .025

T1/CEPT/ISDN-PRI TRANSFORMERS

Dual Surface Mount, 1500 Vrms, Small Package



- Dual SMT package contains both transmit and receive transformers
- Models matched to leading transceiver ICs
- UL 1459 and UL 1950 recognized (some parts pending approval)
- EN 60950 safety agency approval per BABT
- Lead-Free versions available upon request

Electrical Specifications @ 25°C

Part # (STD temp.)	Part # (EXT temp.)	Turns Ratio ^B (Pri:Sec ±5%)	OCL (mH MIN)	C _{w/w} (pF MAX)	L _L (μH MAX)	DCR Pri (Ω MAX)	Package/ Schematic	Primary Pins
PE-65861	T1090	1CT:2CT & 1CT:2CT	1.20 & 1.20	30 & 30	.60 & .60	0.70 & 0.70	BH/1	16-14, 6-8
PE-65862	T1091	1CT:2CT & 1:1.36CT	1.20 & 1.20	30 & 30	.60 & .60	0.70 & 0.70	BH/2	16-14, 6-8
PE-65865	T1076	1:1.15CT & 1CT:2CT	1.20 & 1.20	30 & 30	.60 & .60	0.70 & 0.70	BH/3	16-14, 6-8
PE-65866 ^E	T1092 ^E	1:1/1.26 & 1CT:2CT	1.20 & 1.20	30 & 30	.60 & .60	0.70 & 0.70	BH/3	16-14, 6-8
PE-65870	T1093	1CT:1.15CT & 1CT:1.15CT	1.20 & 1.20	30 & 30	.60 & .60	0.70 & 0.70	BH/1	1-3, 6-8
T1022	T1077	1CT:1CT & 1CT:1.5CT	1.20 & 1.20	30 & 30	.80 & .80	0.70 & 0.70	BH/1	16-14, 6-8
PE-68678	T1094	1CT:1CT & 1CT:2CT	1.20 & 1.20	30 & 30	.60 & .60	0.70 & 0.70	BH/1	16-14, 6-8
PE-68786	T1095	1CT:1.41CT & 1CT:1.41CT	1.00 & 1.00	30 & 30	.60 & .60	0.70 & 0.70	BH/1	16-14, 11-9
T1023	T1096	1CT:1.41CT & 1CT:1.41CT	1.00 & 1.00	30 & 30	.60 & .60	0.70 & 0.70	BH/1	1-3, 11-9
—	T1144	1CT:1CT & 1CT:2.4CT	1.00 & 1.00	30 & 30	.80 & .80	0.85 & 0.85	BH/1	9-11, 1-3
—	T1097	1CT:1CT & 1CT:1.67CT	1.00 & 1.00	25 & 25	.80 & .80	0.80 & 0.80	BH/1	6-8, 14-16
T1136	—	1CT:1CT & 1CT:1.36CT	1.20 & 1.20	30 & 30	.60 & .60	0.70 & 0.70	BH/1	6-8, 1-3
T1121	—	1CT:1.5CT & 1CT:1.5CT	1.50 & 1.50	40 & 40	.80 & .80	0.70 & 0.70	BH/1	1-3, 6-8
T1122	—	1CT:2CT & 1CT:2.3CT	1.20 & 1.20	30 & 30	.80 & .80	0.90 & 0.90	BH/1	6-8, 14-16
T1021 ^J	—	2CT:1/1.26 & 2CT:1/1.26	1.50 & 1.50	40 & 40	.50 & .50	0.70 & 0.70	BH/1	1-3, 11-9
T1075 ^J	—	2CS:1.57/2 & 2CS:1.57/2	1.50 & 1.50	40 & 40	.50 & .50	0.70 & 0.70	BH/4	1-2, 5-6
T1190	—	1CT:1CT & 1CT:1.36CT	1.20 & 1.20	30 & 30	.60 & .60	0.70 & 0.70	BH/1	16-14, 6-8
T1137	TX1287	1CT:2.42CT & 1CT:2.42CT	1.20 & 1.20	25 & 25	.60 & .60	0.70 & 0.70	BH/1	1-3, 6-8
—	T1146	1:2/2.4 & 1:0.79/1	1.00 & 1.00	35 & 35	1.00 & 1.00	0.80 & 0.80	BH/5	1-3, 6-8
T1286	—	1CT:2.4CT & 1CT:2.4CT	1.20 & 1.20	15 & 15	.30 & .30	0.30 & 0.30	BH/1	1-3, 6-8
—	TX1317	1:2CT & 1:2CS	1.20 & 1.20	35 & 35	.50 & 1.00	1.00 & 1.00	BH/6	1-3, 11-9
—	TX1189	1:1.36CT & 1:2CT	1.20 & 1.20	30 & 30	.60 & .60	1.00 & 1.00	BH/7	16-14, 6-8
—	TX1188	1CT:2CT & 1CT:2CT	1.20 & 1.20	30 & 30	.60 & .60	0.70 & 0.70	BH/1	1-3, 6-8
—	TX1187	1CT:2CT & 1:1	1.20 & 1.20	30 & 30	.60 & .60	0.70 & 0.70	BH/8	1-3, 6-8
—	TX1088	1CT:2CT & 1CT:2.42CT	1.20 & 1.20	35 & 35	.80 & .80	1.00 & 1.00	BH/1	1-3, 6-8
—	TX1089	1CT:1CT & 1CT:1CT	1.20 & 1.20	30 & 30	.80 & .80	0.70 & 0.70	BH/1	1-3, 6-8
—	TX1098	1CT:1.26CT & 1CT:1.26CT	1.20 & 1.20	30 & 30	.60 & .60	0.70 & 0.70	BH/1	1-3, 6-8
—	TX1099	1CT:1:0.8 & 1CT:1:0.8	1.20 & 1.20	30 & 30	.80 & .80	1.00 & 1.00	BH/4	16-14, 11-9
—	TX1186	1CT:1.58:2 & 1:1.65:2	1.20 & 1.20	30 & 30	.80 & .80	1.00 & 1.00	BH/9	2-4, 6-7
—	TX1467	1CT:1:1 & 1CT:1:1	1.20 & 1.20	30 & 30	.80 & .80	1.00 & 1.00	BH/4	16-14, 11-9

NOTE: Standard (STD) operating temperature range is 0°C to 70°C. Extended (EXT) operating temperature range is -40°C to +85°C. Models are available with unused leads removed. (See Pages 6 and 7 for Table Notes)

Mechanical

Schematics

BH

SUGGESTED PAD LAYOUT

Weight 1.0 grams
Tape & Reel600/reel
Tube40/tube

Dimensions: $\frac{\text{Inches}}{\text{mm}}$

Unless otherwise specified, all tolerances are $\pm \frac{.010}{.025}$





T1/CEPT/ISDN-PRI TRANSFORMERS

Single Reinforced Insulation, 3 KVRms

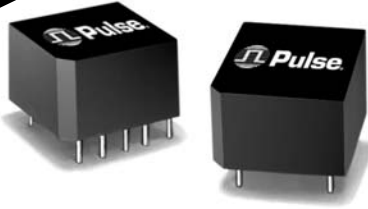

**REINFORCED
INSULATION**



-  Certified for reinforced insulation per EN 41003/EN 60950, UL 1459 and UL 1950
-  For T1/CEPT line interfaces
-  Matched to leading transceiver ICs
-  Designed to meet ITU-T G.703
-  Lead-Free versions available upon request

Electrical Specifications @ 25°C — Operating Temperature 0°C to 70°C (Unless Otherwise Noted)

Part Number	Turns Ratio ^B (±5%)	OCL ^B (mH MIN)	C _{WWW} (pF MAX)	L _L (μH MAX)	DCR Pri (Ω MAX)	DCR Sec (Ω MAX)	Safety Agency Recognition ¹⁰	Package/ Schematic	Primary Pins
PE-65830	1.27CS:1	.800	15	0.70	0.50	0.35	C,T,U,B	IS/3	1-5
PE-65831	1CS:1	.800	15	0.70	0.50	0.45	C,T,U,B	IS/3	1-5
PE-65832	1:1.36CT	1.20	35	0.60	0.70	0.90	C,T,U,B	IS/4	10-6
PE-65833 ^A	1CT:2CT	1.20	20	0.30-0.55	0.50	0.90	C,T,U,B	IS/1	1-5
PE-65834	1:1	1.20	20	0.50	0.50	0.50	C,T,U,B	IS/2	1-5
PE-65835	1CT:2CT	1.20	15	0.80	0.70	1.10	C,T,U,B	IS/1	1-5
PE-65836	1CT:3CT:1	.600	30	0.80	0.70	1.70	C,T,U,B	IS/5	1-3
PE-65837 ^E	1:1.08/1.36	1.50	20	0.60	0.70	0.90	C,T,U,B	IS/4	10-6
PE-65838	1:1.14CT	1.50	30	1.00	0.70	0.90	C,T,U,B	IS/4	10-6
PE-65839 ^E	1:1/1.26	1.50	35	0.60	0.70	1.10	C,T,U,B	IS/4	10-6
PE-68646 ^E	1:1.58/2	1.50	20	0.70	0.70	1.20	C,T,U,B	IS/4	10-6
PE-68788	1CT:1.41CT	1.20	20	0.80	0.60	0.80	T,U,B	IS/1	10-6

NOTE: For surface mount dual version with reinforced insulation products, refer to data sheet T617.

(See Pages 6 and 7 for Table Notes)

Mechanical

Schematics

IS

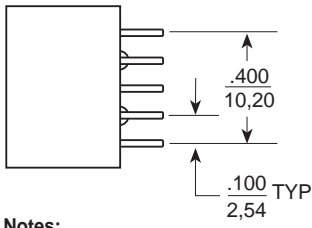
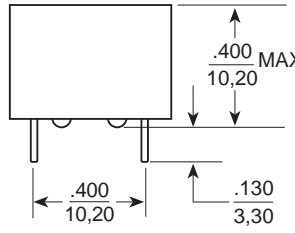
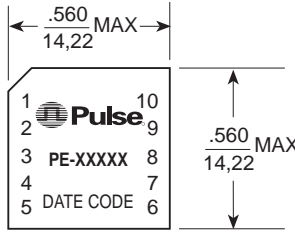

Notes:
Leads are 22 AWG solderable.
Unused pins not provided.

Weight 4 grams
Tube35/tube

Dimensions: $\frac{\text{Inches}}{\text{mm}}$
Unless otherwise specified,
all tolerances are $\pm \frac{.010}{0,25}$

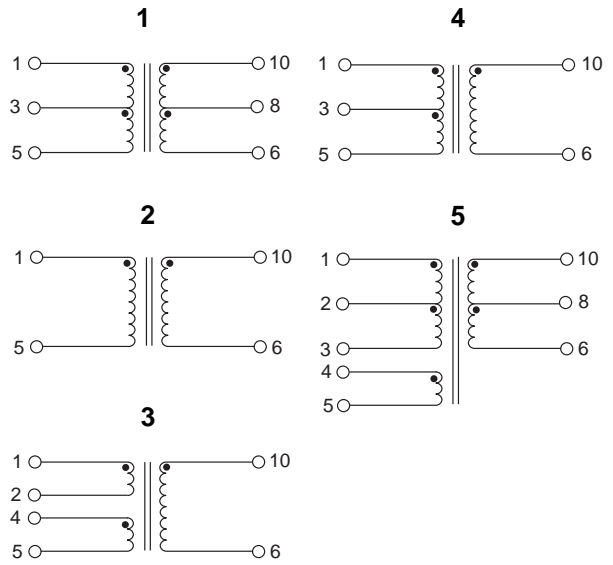

T1/CEPT/ISDN-PRI TRANSFORMERS

Single Through Hole, 1500 Vrms

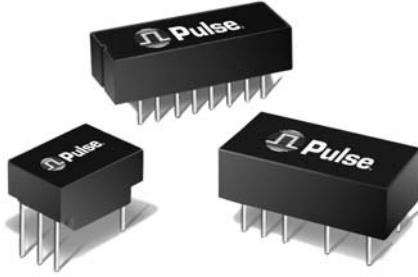

- Extended and standard temperature range
- Dual and single through hole models available
- Models matched to leading transceiver ICs
- Most models UL and BAPT recognized
- Isolation Voltage: 1500 Vrms MIN
- Lead-Free versions available upon request

Electrical Specifications @ 25°C

Part Number	Turns Ratio ^B (Pri:Sec ±5%)	OCL @ 25°C (mH MIN)	C _{w/w} (pF MAX)	L _L (μH MAX)	DCR Pri (Ω MAX)	DCR Sec (Ω MAX)	Package/ Schematic	Primary Pins
STANDARD TEMPERATURE RANGE SINGLE TRANSFORMERS – OPERATING TEMPERATURE 0°C TO +70°C								
PE-64931 ^G	1:1:1 (1:2CS)	1.20	25	0.50	0.70	0.70 & 0.70	HC/2	1-2
PE-64933	1CT:3CT	1.20	30	0.50	0.70	1.60	HC/4	1-5
PE-64934	1:1	1.20	25	0.50	0.70	0.70	HC/1	1-2
PE-64936	1CT:1	1.20	25	0.80	0.70	0.70	HC/3	1-5
PE-64937	1:1.36	1.20	35	0.80	0.70	0.80	HC/1	5-6
PE-64940	1.26CS:1 (1:1:1.58)	0.30	30	0.60	0.80	0.60	HC/2	1-4
PE-64941 ^D	1CS:1	0.80	30	0.60	0.80	0.60	HC/2	1-4
PE-64942	1CS:1.31	0.80	30	0.40	0.80	0.60	HC/2	1-4
PE-64943 ^A	1CT:2CT	1.20	30	0.30-0.55	0.70	1.20	HC/4	1-5
PE-65351 ^G	1:2CT	1.20	40	0.50	0.70	1.30	HC/3	2-6
PE-65363	1:4CT	0.50	40	1.00	0.50	1.50	HC/5	1-5
PE-65379	1:1.14CT	1.20	35	0.80	0.70	0.80	HC/5	1-5
PE-65388	1:1.15CT	1.50	35	0.60	0.70	0.90	HC/3	2-6
PE-65389 ^E	1:1/1.26	1.50	40	0.40	0.70	0.90	HC/3	2-6
PE-65415	1CT:2CT	1.20	30	0.50	0.70	1.20	HC/4	1-5
PE-65558	1:2.3CT	1.20	35	0.80	0.70	1.40	HC/5	1-5
PE-65586	1:1.36CT	1.20	35	0.80	0.70	0.90	HC/5	1-5
PE-65755	1CT:1CT	1.20	25	0.80	0.80	0.80	HC/4	1-5
PE-68644	1CT:1	0.70	20	0.70	0.20	0.80	HC/3	1-5
PE-68645	1:1.36CT	0.70	20	0.70	0.50	0.40	HC/5	1-5
T1054	1:1.5CT	1.20	30	0.60	0.70	1.00	HC/3	2-6
T1249	1:1.26CT	1.20	60	0.80	0.90	1.00	HC/4	2-6
EXTENDED TEMPERATURE RANGE SINGLE TRANSFORMERS 1 – OPERATING TEMPERATURE -40°C TO +85°C								
PE-65340	1:1.36	1.20	35	0.80	0.90	1.20	HC/1	5-6
PE-65770	1:1.15CT	1.50	40	0.80	0.90	1.00	HC/3	2-6
PE-65771	1CT:2CT	1.20	50	0.60	1.00	2.00	HC/4	2-6
PE-65778	1CT:1CT	1.20	40	1.00	1.00	1.00	HC/4	1-5
PE-68600	1CT:3CT	1.20	60	0.80	0.90	2.70	HC/4	1-5
PE-68664 ^E	1:1/1.26	1.50	50	0.80	0.90	1.10	HC/3	2-6
TX1252	1CT:1	1.20	40	1.00	1.00	1.00	HC/3	1-5

(See Pages 6 and 7 for Table Notes)

Mechanical

Schematics

HC

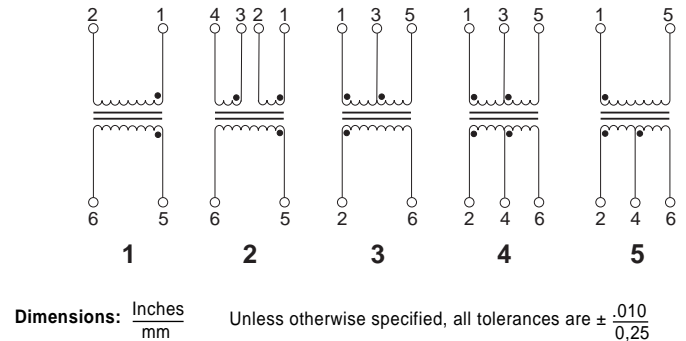
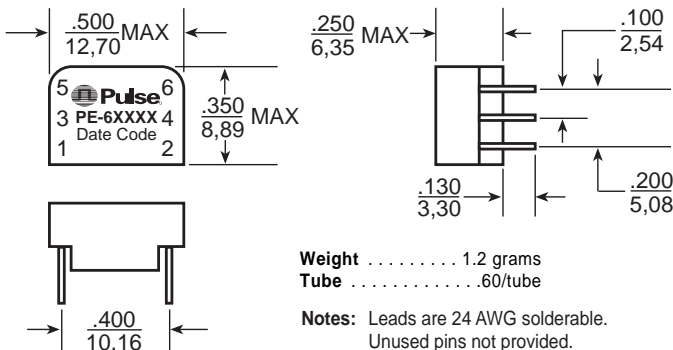

T1/CEPT/ISDN-PRI TRANSFORMERS

Dual Through Hole, 1500 Vrms



Electrical Specifications @ 25°C

Part Number	Turns Ratio ^B (Pri:Sec ±5%)	OCL @ 25°C (mH MIN)	C _{w/w} (pF MAX)	L _L (μH MAX)	DCR Pri (Ω MAX)	DCR Sec (Ω MAX)	Package/ Schematic	Primary Pins
STANDARD TEMPERATURE RANGE DUAL TRANSFORMERS – OPERATING TEMPERATURE 0°C TO +70°C								
PE-64951	1:2CT & 1:2CT	1.20 & 1.20	35 & 35	0.50 & 0.50	0.70 & 0.70	1.20 & 1.20	HD/1	14-12, 5-7
PE-64952	1:2CT & 1:1.36	1.20 & 1.20	35 & 35	0.50 & 0.80	0.80 & 0.80	1.20 & 1.00	HD/2	14-12, 5-7
PE-64953	1:2CT & 1:2CT	2.00 & 2.00	50 & 50	0.60 & 0.60	1.00 & 1.00	2.00 & 2.00	HD/3	14-12, 10-8
PE-64954 ^A	1CT:2CT & 1:1	1.20 & 1.20	30 & 30	0.30-0.55 & 0.50	0.70 & 0.70	1.20 & 0.70	HD/4	1-3, 5-7
PE-64955	1:1.26CT & 1.58:1	0.80 & 0.80	30 & 30	0.50 & 0.50	0.60 & 0.60	0.70 & 0.30	HD/5	1-3, 5-7
PE-64956	1:1CT & 2:1	0.80 & 0.80	30 & 30	0.60 & 0.60	0.50 & 0.50	0.50 & 0.20	HD/5	1-3, 5-7
PE-64957	1CT:1.31 & 2.62:1	1.20 & 1.20	30 & 30	0.80 & 0.80	0.60 & 0.60	0.50 & 0.30	HD/5	1-3, 5-7
PE-65565	1:1.15CT & 1:2CT	1.50 & 1.20	35 & 40	0.60 & 0.50	0.70 & 0.70	1.10 & 1.30	TD/1	14-12, 5-7
PE-65566 ^E	1:1/1.26 & 1:2CT	1.50 & 1.20	40 & 40	0.50 & 0.40	0.70 & 0.70	0.90 & 1.30	TD/1	14-12, 5-7
EXTENDED TEMPERATURE RANGE DUAL TRANSFORMERS ¹ – OPERATING TEMPERATURE -40°C TO +85°C								
PE-65567	1:1.15CT & 1:2CT	1.50 & 1.20	40 & 60	0.80 & 0.80	0.90 & 0.90	1.00 & 1.70	TD/1	14-12, 5-7
PE-65568 ^E	1:1/1.26 & 1:2CT	1.50 & 1.20	50 & 60	0.80 & 0.80	0.90 & 0.90	1.00 & 1.70	TD/1	14-12, 5-7
PE-65774	1CT:2CT & 1:1.36CT	1.20 & 1.20	50 & 50	0.96 & 0.80	1.00 & 1.00	1.70 & 1.20	TD/7	14-12, 5-7
PE-68618 ^H	1CT:1CT & 3CT:1CT:25	1.20 & 32.0	40 & 65	0.80 & 0.80	1.00 & 3.00	1.00 & 1.20	BD/6	1-3, 11-9
PE-64950 ^H	1CT:1CT & 1CT:3CT:1	1.20 & 0.60	50 & 50	0.80 & 0.80	1.00 & 0.80	1.00 & 2.00	BD/6	1-3, 4-6

(See Pages 6 and 7 for Table Notes)

Mechanicals

**TD
DUAL**

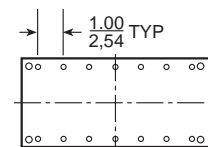
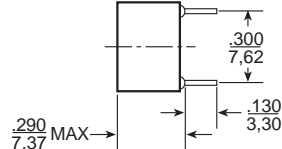
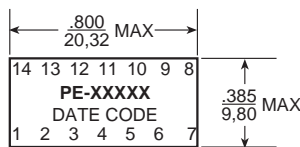

Weight 2.6 grams
Tube25/tube

**HD
DUAL**

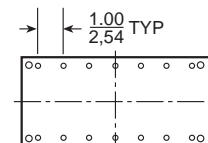
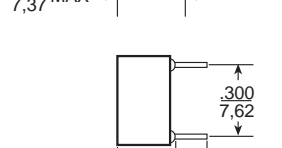
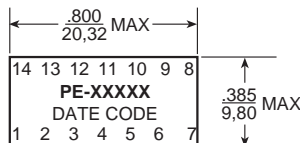

Weight 2.3 grams
Tube25/tube

**BD
DUAL**

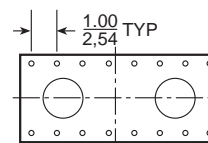
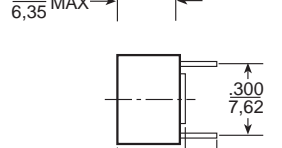
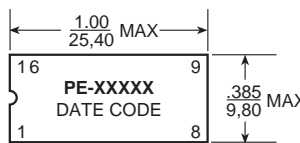

Weight 3.1 grams
Tube25/tube

Note: Leads are 24 AWG solderable.

Dimensions: Inches
mm

Unless otherwise specified all tolerances are ±.010
0,25

Schematics

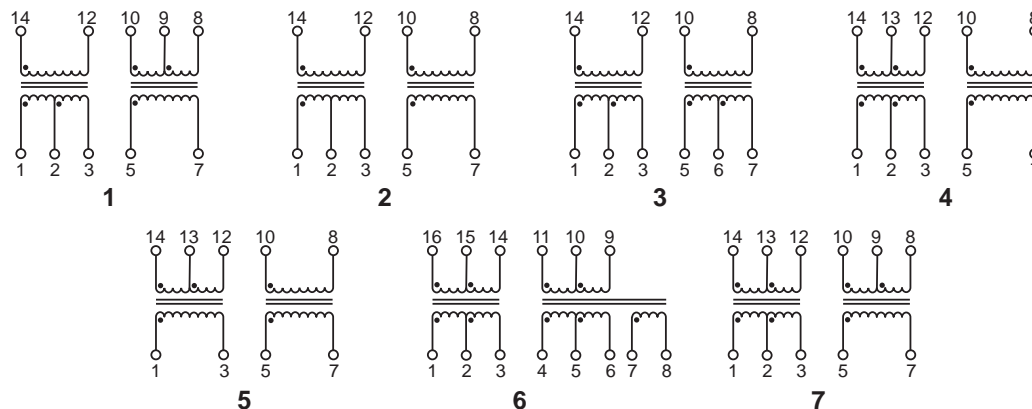

T1/CEPT/ISDN-PRI TRANSFORMERS

Transformer Selection Guide



IC Manufacturer IC Part Number	Comments	Dual SMT (BH pkg.)		Dual SMT (AN pkg.)		Single Through Hole				Dual Through Hole		Reinforced 3 kVrms Single Through Hole	
		Std Temp	Ext Temp	Std Temp	Ext Temp	Standard Temp		Extended Temp		Std Temp	Ext Temp		
		TX & RX	TX & RX	TX & RX	TX & RX	TX	RX	TX	RX	TX & RX	TX & RX	TX	RX
MINDSPEED (CONEXANT)													
BT8510	T1/E1	PE-65866	T1092	PE-68866	PE-68826	PE-65389	PE-65351	PE-68664	PE-65771	PE-65566	PE-65568	PE-65839	PE-65835
BT8510	T1/E1	T1021	T1092	T1021	PE-68826	PE-65389	PE-65351	PE-68664	PE-65771	PE-65566	PE-65568	PE-65839	PE-65835
BT8370/5/6	BETTER RL	T1190	T1091	PE-68862	PE-68822	PE-64937	PE-64936	PE-65340	PE-65771	PE-64952	PE-65774	PE-65832	PE-65834
BT8370/5/6	LOW POWER	PE-65865	T1076	PE-68868	PE-68825	PE-65388	PE-64936	PE-65770	PE-65771	PE-65565	PE-65567	PE-65838	PE-65834
CIRRUS LOGIC (CRYSTAL)													
61318	120 E1	PE-68678	T1094	PE-68877	PE-68877	PE-65351	PE-64936	PE-65771	PE-65778	PE-64951	PE-65568	PE-65835	PE-65835
61318	75 E1					T1229	PE-64936	T1229	PE-65778			PE-65835	PE-65835
61577	T1 & E1	PE-65861	T1090	PE-68861	PE-68841	PE-65351	PE-65351	PE-65771	PE-65771	PE-64951		PE-65835	PE-65835
61304A/5A/535A/574A,/75	T1	PE-65865	T1076	PE-68865	PE-68825	PE-65388	PE-65351	PE-65770	PE-65771	PE-65565	PE-65567	PE-65838	PE-65835
61304A/5A/535A/574A,/75	75 E1	PE-65866	T1092	PE-65866	PE-68826	PE-65389	PE-65351	PE-68664	PE-65771	PE-65566	PE-65568	PE-65839	PE-65835
61304A/5A/535A/574A,/75	120 E1	PE-65866	T1092	PE-65866	PE-68826	PE-65389	PE-65351	PE-68664	PE-65771	PE-65566	PE-65568	PE-65839	PE-65835
61582, 61583		PE-65870	T1093	PE-68874	PE-68874	PE-65388	PE-65388	PE-65770	PE-65770			PE-65838	PE-65838
61310, 61581		PE-68678	T1094	PE-68877	PE-68877	PE-65351	PE-64936	PE-65771	PE-68778	PE-64951	PE-65568	PE-65835	PE-65835
61310, 61581	Host	T1022	T1077	T1022		PE-65351	PE-65351	PE-65771	PE-65771	PE-64951		PE-65835	PE-65835
61881		PE-65865	T1076	PE-68865	PE-68825	PE-65388	PE-65351	PE-65770	PE-65771	PE-65565	PE-65567	PE-65838	PE-65835
61584/84A	IQ3	PE-65861	T1090	PE-68861	PE-68841	PE-65351	PE-65351	PE-65771	PE-65771	PE-64951		PE-65835	PE-65835
61584/82/83/A	IQ5	PE-65870	T1093	PE-68874	PE-68874	PE-65388	PE-65388	PE-65770	PE-65770			PE-65838	PE-65838
MAXIM (DALLAS)													
DS2196		PE-68678	T1094	PE-68877	PE-68877	PE-65351	PE-64936	PE-65771	PE-65778	PE-64951	PE-65568	PE-65838	PE-65838
DS2151/2152/2153/2154		PE-65865	T1076	PE-68865	PE-68825	PE-65388	PE-64936	PE-65770	PE-65778	PE-65565	PE-65567	PE-65838	PE-65834
DS2151/2152/2153/2154		T1136	T1091	PE-68862	PE-68822	PE-65586	PE-64936	PE-65340	PE-65778	PE-64952	PE-65774	PE-65832	PE-65834
DS2148/Q48	3V	PE-68678	T1094	PE-68877	PE-68877	PE-65351	PE-64936	PE-65771	PE-65778	PE-64951	PE-65568	PE-65838	PE-65838
DS2148/Q48	5V	T1136	T1091	PE-68862	PE-68822	PE-65586	PE-64936	PE-65340	PE-65778	PE-64952	PE-65774	PE-65832	PE-65834
DS21352/Q352,DS21354/Q354		PE-68678	T1094	PE-68877	PE-68877	PE-65351	PE-64936	PE-65771	PE-65778	PE-64951	PE-65568	PE-65838	PE-65834
DS21552/Q552,DS21554/Q554		PE-65865	T1076	PE-68865	PE-68825	PE-65388	PE-64936	PE-65770	PE-65778	PE-65565	PE-65567	PE-65838	PE-65834
DS21552/Q552,DS21554/Q554		T1136	T1091	PE-68862	PE-68822	PE-65586	PE-64936	PE-65340	PE-65778	PE-64952	PE-65774	PE-65832	PE-65834
EXAR													
T5683A, 59L91		PE-65861	T1090	PE-68861	PE-68841	PE-65415	PE-65415	PE-65771	PE-65771	PE-64951		PE-65835	PE-65835
T5894,T5897,T5997		PE-65861	T1090	PE-65861	PE-68841	PE-65415	PE-65415	PE-65771	PE-65771	PE-64951		PE-65835	PE-65835
T5791/93/94/95		PE-65866	T1092	PE-68866	PE-68826	PE-65389	PE-64934	PE-68664	PE-65778	PE-65566	PE-65568	PE-65839	PE-65835
81L27,82L24,82D20		PE-65862	T1091	PE-68862	PE-68822	PE-64937	PE-65415	PE-65340	PE-65771	PE-64952	PE-65774	PE-65832	PE-65835
83L30/34/38		PE-65861	T1090	PE-65861	PE-68841	PE-65415	PE-65415	PE-65771	PE-65771	PE-64951		PE-65835	PE-65835
82L34/38													
T5684,T7288,82D20		PE-65862	T1091	PE-68862	PE-68822	PE-64937	PE-65351	PE-65340	PE-65771	PE-64952	PE-65774	PE-65837	PE-65835
INFINEON TECHNOLOGIES (SIEMENS)													
PEB 2254/55	E1/T1 & J1	PE-68786	T1095	PE-68887	PE-68887							PE-68788	PE-68788
PEB 2254/55	E1/T1 & J1	T1023	T1096	PE-68887	PE-68887								
PEB 22504	3.3V	T1144	T1144										
PEB22554	3.3V	T1144	T1144										
PEB2256 3.3 V	E1/T1/J1	T1144	T1144										
INTEL (LEVEL ONE)													
LXT 300/301		PE-65861	T1090	PE-68861	PE-68841	PE-65351	PE-65351	PE-65771	PE-65771	PE-64951		PE-65835	PE-65835
LXT 304/305/307	T1,E1	PE-65861	LXT 300	PE-68861	PE-68841	PE-65351	PE-65351	PE-65771	PE-65771	PE-64951		PE-65835	PE-65835
LXT 304/305/307	T1	PE-65865	T1076	PE-68865	PE-68825	PE-65388	PE-65351	PE-65770	PE-65771	PE-65565	PE-65567	PE-65838	PE-65835
LXT 304/305/307	75E1,120E1	PE-65866	T1092	PE-68866	PE-68826	PE-65389	PE-65351	PE-68664	PE-65771	PE-65566	PE-65568	PE-65839	PE-65835
LX T 304/305/307	DSX-1, D4	T1122		PE-68881	PE-68881	PE-65558	PE-65351						
LXT 310/317/318		PE-68678	T1094	PE-68877	PE-68877	PE-65351	PE-64936	PE-65771	PE-65778	PE-64954		PE-65835	PE-65834
LXT 312/ 313/ 315						PE-64933	PE-64936	PE-68600	PE-65778		PE-64950	PE-65836	PE-65834
LXT 331	T1,E1	PE-68678	T1094	PE-68877	PE-68877	PE-65351	PE-64936	PE-65771	PE-65778	PE-64954		PE-65835	PE-65834
LXT 331, LXT 332		PE-65861	T1090	PE-68861	PE-68841	PE-65351	PE-65351	PE-65771	PE-65771	PE-64951		PE-65835	PE-65835
LXT 331, LXT 332		T1122		PE-68881	PE-68881	PE-65558	PE-65351						
LXT 331, LXT 332		PE-65865	T1076	PE-68865	PE-68825	PE-65388	PE-65351	PE-65770	PE-65771	PE-65565	PE-65567	PE-65838	PE-65835
LXT 334, LXT 335	T1/E1	PE-65861	T1090	PE-68861	PE-68841	PE-65351	PE-65351	PE-65771	PE-65771	PE-64951		PE-65835	PE-65835
LXT 334, LXT 335	120/75 E1	PE-65862	T1091	PE-68862	PE-68822	PE-65586	PE-65351	PE-65340	PE-65771	PE-64952	PE-65771	PE-65832	PE-65835
LXT 334, LXT 335	75 E1	PE-65866	T1092	PE-68866	PE-68826	PE-65389	PE-65351	PE-68664	PE-65771	PE-65566	PE-65568	PE-65839	PE-65835
LXT 334, LXT 335		T1022	T1077			T1054	PE-64936						
LXT 336		PE-65861	T1090	PE-68828	PE-68828	PE-65351	PE-65351	PE-65778	PE-65778	PE-64951		PE-65835	PE-65835
LXT 350, LXT 351, LXT 359	T1,E1	PE-68678	T1094	PE-68877	PE-68877	PE-65351	PE-64936	PE-65771	PE-65778	PE-64954		PE-65835	PE-65834
LXT 350, LXT 351		PE-65865	T1076	PE-68865	PE-68825	PE-65388	PE-65351	PE-65770	PE-65771	PE-65565	PE-65567	PE-65838	PE-65835
LXT 350, LXT 351		T1122		PE-68881	PE-68881	PE-65558	PE-65351						
LXT 360/361/362/363	120 E1	PE-68678	T1094	PE-68877	PE-68877	PE-65351	PE-64936	PE-65771	PE-65778	PE-64954		PE-65835	PE-65834
LXT 360/361/362/363	T1,E1	PE-65865	T1076	PE-68865	PE-68825	PE-65388	PE-65351	PE-65770	PE-65771	PE-65565	PE-65567	PE-65838	PE-65835
LXT 360, LXT361	120 E1	T1122		PE-68881	PE-68881	PE-65558	PE-65351						
LXT 380/381/384/386/388	T1/E1	PE-68678	T1094	PE-68877	PE-68877	PE-65351	PE-64936	PE-65771	PE-65778	PE-64954		PE-65835	PE-65834
LXT 380/381/384/386/388	T1/E1	PE-65861	T1090	PE-68861	PE-68841	PE-65351	PE-65351	PE-65771	PE-65771	PE-64951		PE-65835	PE-65835
LXT 3104, LXT 3108		PE-65861	T1090	PE-68861	PE-68841	PE-64936	PE-64936	PE-65778	PE-65778	PE-64951		PE-65835	PE-65835
LXT 3104, LXT 3108		TX1099	TX1099										
LUCENT TECHNOLOGIES													
T7288, T290A	CEPT	PE-65862	T1091	PE-68862	PE-68822	PE-65586	PE-65415	PE-65340	PE-65771	PE-64952	PE-65774	PE-65832	PE-65835
T7289A	DS1	PE-65865	T1076	PE-68865	PE-68825	PE-65379	PE-65351	PE-65770	PE-65771	PE-65565	PE-65567	PE-65838	PE-65835
T7688, T7690, T7698	CEPT			PE-68884	PE-68884	PE-65586	PE-65586	PE-65340	PE-65340			PE-65832	PE-65832
T7689, T7690, T7698	DS1	PE-65870	T1093	PE-68874	PE-68874	PE-65379	PE-65379	PE-65770	PE-65770			PE-65838	PE-65838
T7693, T7697	CEPT	T1137	TX1287										
TLIU04C1	DS1	PE-65870	T1093	PE-68874	PE-68874	PE-65379	PE-65379	PE-65770	PE-65770			PE-65838	PE-65838
TLIU04C1	CEPT			PE-68884	PE-68884	PE-65586	PE-65586	PE-65340	PE-65340			PE-65832	PE-65832
ZARLINK (MITEI)													
MT9071, MT9076		T1137	TX1287										
MT9076, MT9075		T1144	T1144	</									

T1/CEPT/ISDN-PRI TRANSFORMERS

Application Notes



- Extended Temperature Range Models** — For extended temperature range transformers (-40°C to +85°C operating temperature range), OCL (Open Circuit Inductance for the primary winding) is specified at both -40°C and +25°C. At -40°C, OCL is 600 µH minimum for all low temperature models with the exception of PE-68827 which is 800 µH minimum and PE-65836 which is 300 µH minimum. All other parameters are specified at +25°C only. Standard temperature range is 0°C to +70°C.
- ET Product** — All coils have an ET product of 10 V-µsec minimum.
- Flammability** — Materials used in the products are recognized as UL94-VO approved. Products meet the requirements of IEC 695-2-2 (Needle Flame Test).
- Balance Characteristics** — The transformers meet the requirements for longitudinal balance of FCC part 68.
- Common Mode Rejection Ratio** — the CMRR for all transformers is better than 50 dB at 1 MHz. A typical test circuit is shown below.

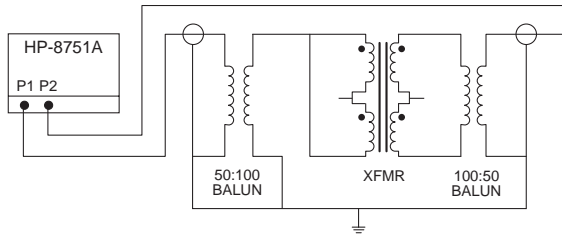

- Crosstalk Attenuation** — In the dual packages, which contain transmit and receive transformers side by side, sufficient crosstalk attenuation is achieved by the inherent characteristics of the toroid cores as well as by their proper positioning. The crosstalk attenuation is typically 50 dB or better from 100 KHz to 10 MHz. This result was established with the test circuit shown below.

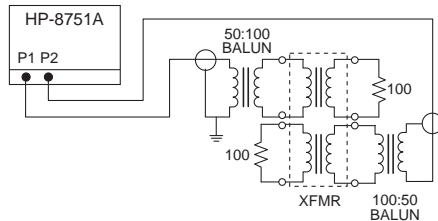

- Return Loss** — ITU-T G.703 and European national regulatory documents specify minimum return loss levels. The transformers will allow these limits to be complied within the situations where they are applicable.

Frequency	50-100 KHz	100 KHz-2 MHz	2-3 MHz
Return Loss			
XMIT	9 dB	15 dB	11 dB
REC	12 dB	18 dB	14 dB

- Surge Voltage Capability** — All transformers and chokes meet surge voltage tests according to the most stringent regulatory documents when system designs include the proper voltage and current suppression devices:

Metallic Voltage:	800 V peak, 10/560 µsec
Longitudinal Voltage:	2,400 V peak, 10/700 µsec

NOTES FROM TABLES (pages 1 through 6):

- Toleranced leakage inductance: .30 µH min to .55 µH MAX.
- OCL (primary inductance) and L_L (leakage inductance) are measured at the primary winding. Turns ratio is specified primary: secondary. (CT = Center Tap; CS = Split Center Tap).
- To make a 1CT:1 ratio from a 1CT:2CT ratio, use only one half of the secondary (2CT) winding.
- For Reinforced 3kVrms Dual SMT Transformers, refer to data sheet T617. For Quad SMT Transformers refer to data sheet T615. For Octal SMT Transformers refer to data sheet T622.
- Dual Ratio Transformers — These transformers have tapped secondary windings to provide two turns ratios (T/R). Use the entire primary winding and connect the secondary pins listed below to obtain the desired turns ratio:

Part Number	Turns Ratio 1	Secondary Pins	Turns Ratio 2	Secondary Pins
PE-65837	1:1.08	3-5	1:1.36	1 - 5
PE-65839	1:1	3-5	1:1.26	1 - 5
PE-65866	1:1	2-3	1:1.26	1 - 3
PE-68646	1:1.58	3-5	1:2	1 - 5
PE-65389	1:1	3-5	1:1.26	1 - 5
PE-65566	1:1	2-3	1:1.26	1 - 3
PE-65568	1:1	2-3	1:1.26	1 - 3
PE-68866	1:1	2-3	1:1.26	1 - 3
PE-68826	1:1	2-3	1:1.26	1 - 3
PE-68664	1:1	3-5	1:1.26	1 - 5
PE-68836	1:1	2-3/5-6	1:1.26	1-3/4-6

- Standard packaging for surface mount "AN" and "LA" packages is anti-static tubes. Optional tray packaging can be ordered by adding "R" suffix to the part number, (i.e. PE-65857R). Optional Tape & Reel packaging can be ordered by adding "T" suffix to the part number, (i.e. PE-65857T).

- Isolation Voltage** — 100% of transformers are tested during production to the specified isolation voltage level.
- Safety Agency Recognition** — Parts listed as "Recognized" or "Certified" meet Underwriter Laboratories, UL 1459 and UL 1950 per file E133523 (S).

British Approvals Board for Telecommunications

BABT BS 6301:1989/BS 415 and BS EN 41003:1991/EN 60 950, supplementary insulation.

CR/0091

PE-64933	PE-65351	PE-65558	PE-68600
PE-64934	PE-65363	PE-65586	PE-68644
PE-64936	PE-65379	PE-65755	PE-68645
PE-64937	PE-65388	PE-65770	PE-68664
PE-64943	PE-65389	PE-65771	
PE-65340	PE-65415	PE-65778	

Transformers with Reinforced Insulation according to IEC950 series PE-68630—PE-68788 (page 3) are certified by the following organizations:

Code Certificate Information

C	CSA, C22.2 #950 & #225, Cert. LR 76802-3, reinforced insulation.
T	TÜV, EN 60 950/EN 41003, Cert. R9371358, reinforced insulation.
U	UL 1459/UL1950, File E133523 (S), reinforced insulation.
B	BABT EN41003/EN60950, Cert. CR0079, reinforced insulation.

(Note: Safety Agency approval of surface mount transformers is pending.)

- General Information** — The transformers are specifically designed for use in 1.544 Mbps (T1), 2.048 Mbps (CEPT) and ISDN Primary rate (PRI) interface applications. They are matched to the majority of the line interface transceiver ICs currently available. Use of the proper transformer allows the interface circuit to comply with ITU-T G.703 and other standards regarding pulse waveform, return loss, and balance.

- Common Mode Chokes** — The "high-frequency" 4-lines common mode chokes shown in this data sheet provide an effective means of compliance with national and international regulations on EMI. They are designed to be used in conjunction with Pulse's T1/CEPT transformers as shown in the typical application below. Crosstalk is typically -70 dB at 1 MHz and -55 dB at 10 MHz.

Typical Application

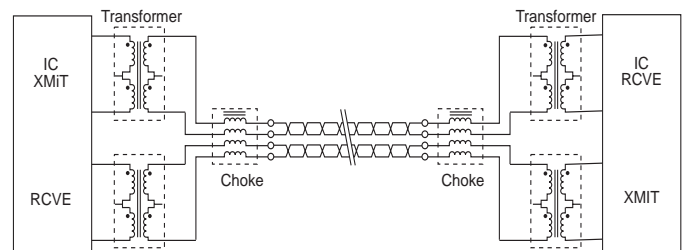

- PE-64931 and PE-65351 are electrically equivalent, but have different schematics. PE-65351 is both UL 1459 and BABT recognized and is recommended for new designs because the 3S schematic provides greater physical separation between the primary and secondary pins.

- PE-68618 and PE-64950: The fault locate winding is (7-8).

- Safety Agency approvals pending.

- The turns ratio of these devices have been designed, in conjunction with semiconductor vendor recommendations, to allow connections to various terminations (e.g. 75 or 120 Ω with the same transformer). For example T1075 can be used with the Siemens PEB 2235 to achieve connection to the 75 or 120 Ω cable. For 75 Ω termination, the PEB 2235 requires the following turns ratio: 1:1.57 (Tx) and 1:1.26 (Rx) which can be achieved using pins (1-2):(15-16) for Tx and (10-11):(5-8) for Rx. For 120 Ω, the following turns ratio are required: 1:2 (Tx) and 1:1 (Rx), which are pins (1-2):(16-14) for Tx and (9-11):(5-8) for Rx on the T1075.

Copyright © Each Manufacturing Company.

All Datasheets cannot be modified without permission.

This datasheet has been download from :

www.AllDataSheet.com

100% Free DataSheet Search Site.

Free Download.

No Register.

Fast Search System.

www.AllDataSheet.com

Компания «Life Electronics» занимается поставками электронных компонентов импортного и отечественного производства от производителей и со складов крупных дистрибьюторов Европы, Америки и Азии.

С конца 2013 года компания активно расширяет линейку поставок компонентов по направлению коаксиальный кабель, кварцевые генераторы и конденсаторы (керамические, пленочные, электролитические), за счёт заключения дистрибьюторских договоров

Мы предлагаем:

- Конкурентоспособные цены и скидки постоянным клиентам.
- Специальные условия для постоянных клиентов.
- Подбор аналогов.
- Поставку компонентов в любых объемах, удовлетворяющих вашим потребностям.
- Приемлемые сроки поставки, возможна ускоренная поставка.
- Доставку товара в любую точку России и стран СНГ.
- Комплексную поставку.
- Работу по проектам и поставку образцов.
- Формирование склада под заказчика.
- Сертификаты соответствия на поставляемую продукцию (по желанию клиента).
- Тестирование поставляемой продукции.
- Поставку компонентов, требующих военную и космическую приемку.
- Входной контроль качества.
- Наличие сертификата ISO.

В составе нашей компании организован Конструкторский отдел, призванный помогать разработчикам, и инженерам.

Конструкторский отдел помогает осуществить:

- Регистрацию проекта у производителя компонентов.
- Техническую поддержку проекта.
- Защиту от снятия компонента с производства.
- Оценку стоимости проекта по компонентам.
- Изготовление тестовой платы монтаж и пусконаладочные работы.



Тел: +7 (812) 336 43 04 (многоканальный)

Email: org@lifeelectronics.ru