

RF Power Field Effect Transistor

N-Channel Enhancement-Mode Lateral MOSFET

Designed for broadband commercial and industrial applications with frequencies to 520 MHz. The high gain and broadband performance of this device make it ideal for large-signal, common source amplifier applications in 12.5 volt mobile FM equipment.

- Specified Performance @ 520 MHz, 12.5 Volts
Output Power — 8 Watts
Power Gain — 13 dB
Efficiency — 60%
- Capable of Handling 20:1 VSWR, @ 15.5 Vdc, 520 MHz, 2 dB Overdrive

Features

- Excellent Thermal Stability
- Characterized with Series Equivalent Large-Signal Impedance Parameters
- N Suffix Indicates Lead-Free Terminations. RoHS Compliant.
- In Tape and Reel. T1 Suffix = 1,000 Units per 12 mm, 7 inch Reel.

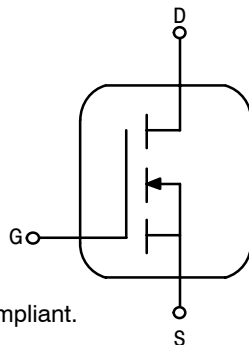

MRF1518NT1

**520 MHz, 8 W, 12.5 V
LATERAL N-CHANNEL
BROADBAND
RF POWER MOSFET**

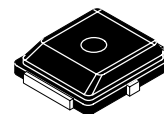

**CASE 466-03, STYLE 1
PLD-1.5**

PLASTIC

Table 1. Maximum Ratings

Rating	Symbol	Value	Unit
Drain-Source Voltage	V_{DSS}	-0.5, +40	Vdc
Gate-Source Voltage	V_{GS}	± 20	Vdc
Drain Current — Continuous	I_D	4	Adc
Total Device Dissipation @ $T_C = 25^\circ\text{C}$ (1) Derate above 25°C	P_D	62.5 0.50	W W/ $^\circ\text{C}$
Storage Temperature Range	T_{stg}	-65 to +150	$^\circ\text{C}$
Operating Junction Temperature	T_J	150	$^\circ\text{C}$

Table 2. Thermal Characteristics

Characteristic	Symbol	Value (2)	Unit
Thermal Resistance, Junction to Case	$R_{\theta JC}$	2	$^\circ\text{C}/\text{W}$

Table 3. Moisture Sensitivity Level

Test Methodology	Rating	Package Peak Temperature	Unit
Per JESD22-A113, IPC/JEDEC J-STD-020	3	260	$^\circ\text{C}$

1. Calculated based on the formula $P_D = \frac{T_J - T_C}{R_{\theta JC}}$

2. MTTF calculator available at <http://www.freescale.com/rf>. Select Software & Tools/Development Tools/Calculators to access MTTF calculators by product.

NOTE - CAUTION - MOS devices are susceptible to damage from electrostatic charge. Reasonable precautions in handling and packaging MOS devices should be observed.

Table 4. Electrical Characteristics ($T_A = 25^\circ\text{C}$ unless otherwise noted)

Characteristic	Symbol	Min	Typ	Max	Unit
Off Characteristics					
Zero Gate Voltage Drain Current ($V_{DS} = 40\text{ Vdc}$, $V_{GS} = 0\text{ Vdc}$)	I_{DSS}	—	—	1	μAdc
Gate-Source Leakage Current ($V_{GS} = 10\text{ Vdc}$, $V_{DS} = 0\text{ Vdc}$)	I_{GSS}	—	—	1	μAdc
On Characteristics					
Gate Threshold Voltage ($V_{DS} = 12.5\text{ Vdc}$, $I_D = 100\ \mu\text{A}$)	$V_{GS(th)}$	1	1.6	2.1	Vdc
Drain-Source On-Voltage ($V_{GS} = 10\text{ Vdc}$, $I_D = 1\text{ Adc}$)	$V_{DS(on)}$	—	0.4	—	Vdc
Dynamic Characteristics					
Input Capacitance ($V_{DS} = 12.5\text{ Vdc}$, $V_{GS} = 0$, $f = 1\text{ MHz}$)	C_{iss}	—	66	—	pF
Output Capacitance ($V_{DS} = 12.5\text{ Vdc}$, $V_{GS} = 0$, $f = 1\text{ MHz}$)	C_{oss}	—	33	—	pF
Reverse Transfer Capacitance ($V_{DS} = 12.5\text{ Vdc}$, $V_{GS} = 0$, $f = 1\text{ MHz}$)	C_{rss}	—	4.5	—	pF
Functional Tests (In Freescale Test Fixture)					
Common-Source Amplifier Power Gain ($V_{DD} = 12.5\text{ Vdc}$, $P_{out} = 8\text{ Watts}$, $I_{DQ} = 150\text{ mA}$, $f = 520\text{ MHz}$)	G_{ps}	—	13	—	dB
Drain Efficiency ($V_{DD} = 12.5\text{ Vdc}$, $P_{out} = 8\text{ Watts}$, $I_{DQ} = 150\text{ mA}$, $f = 520\text{ MHz}$)	η	—	60	—	%

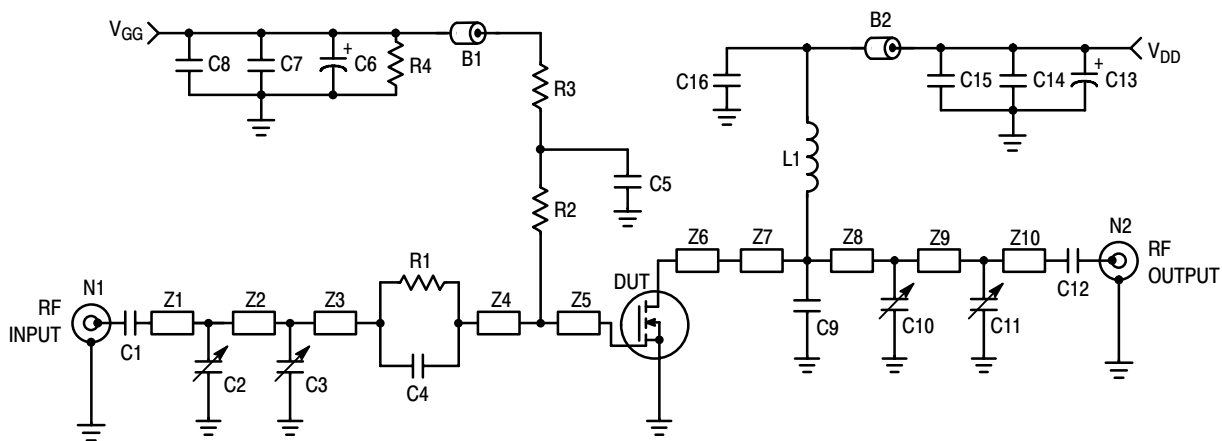

B1, B2	Short Ferrite Beads, Fair Rite Products (2743021446)	R4	33 k Ω , 1/8 W Resistor
C1, C12	240 pF, 100 mil Chip Capacitors	Z1	0.451" x 0.080" Microstrip
C2, C3, C10, C11	0 to 20 pF Trimmer Capacitors	Z2	1.005" x 0.080" Microstrip
C4	82 pF, 100 mil Chip Capacitor	Z3	0.020" x 0.080" Microstrip
C5, C16	120 pF, 100 mil Chip Capacitors	Z4	0.155" x 0.080" Microstrip
C6, C13	10 μ F, 50 V Electrolytic Capacitors	Z5, Z6	0.260" x 0.223" Microstrip
C7, C14	1,200 pF, 100 mil Chip Capacitors	Z7	0.065" x 0.080" Microstrip
C8, C15	0.1 μ F, 100 mil Chip Capacitors	Z8	0.266" x 0.080" Microstrip
C9	30 pF, 100 mil Chip Capacitor	Z9	1.113" x 0.080" Microstrip
L1	55.5 nH, 5 Turn, Coilcraft	Z10	0.433" x 0.080" Microstrip
N1, N2	Type N Flange Mounts	Board	Glass Teflon [®] , 31 mils, 2 oz. Copper
R1	15 Ω Chip Resistor (0805)		
R2	51 Ω , 1/2 W Resistor		
R3	10 Ω Chip Resistor (0805)		

Figure 1. 450 - 520 MHz Broadband Test Circuit

TYPICAL CHARACTERISTICS, 450 - 520 MHz

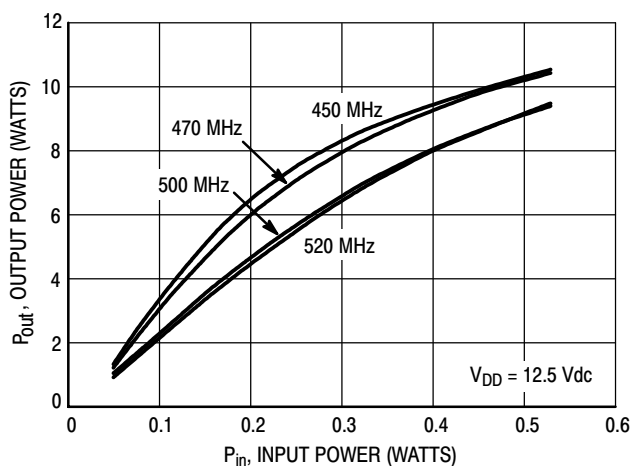

Figure 2. Output Power versus Input Power

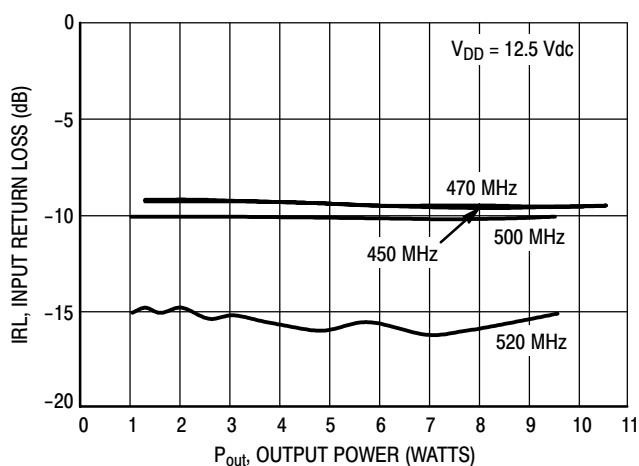

Figure 3. Input Return Loss versus Output Power

TYPICAL CHARACTERISTICS, 450 - 520 MHz

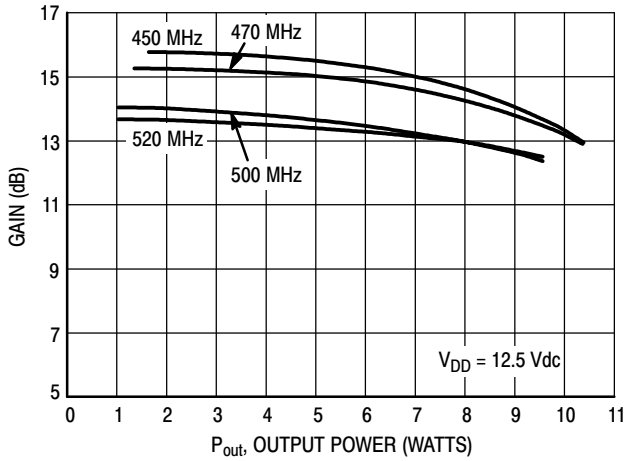

Figure 4. Gain versus Output Power

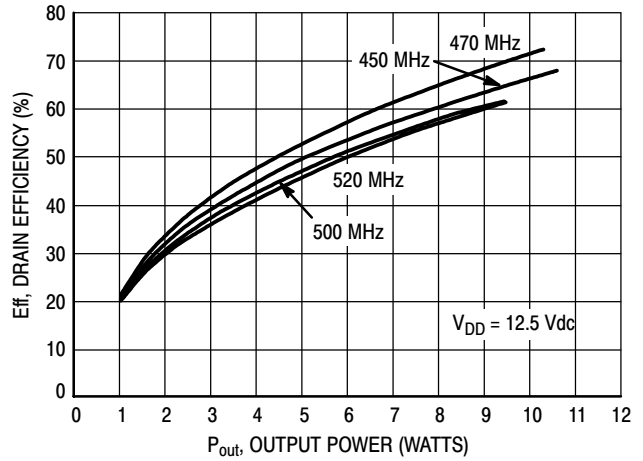

Figure 5. Drain Efficiency versus Output Power

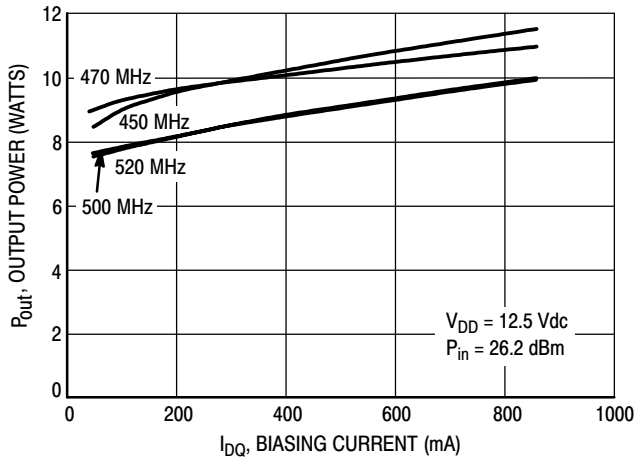

Figure 6. Output Power versus Biasing Current

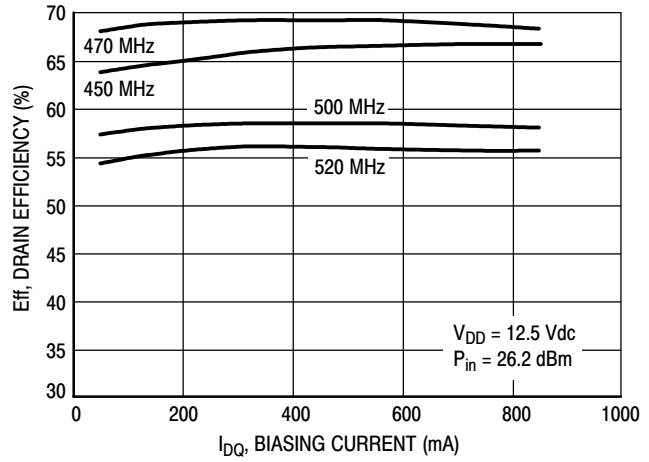

Figure 7. Drain Efficiency versus Biasing Current

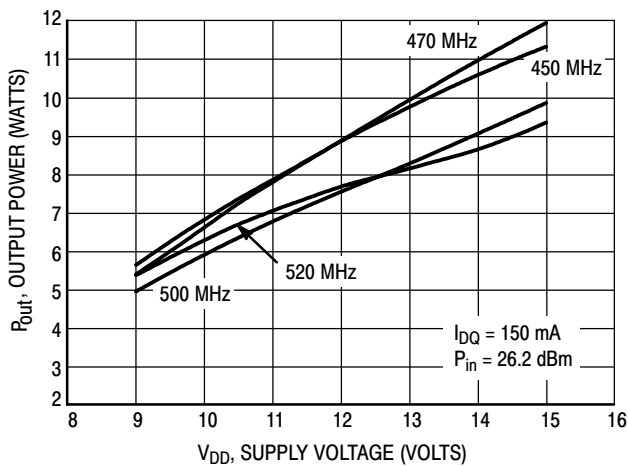

Figure 8. Output Power versus Supply Voltage

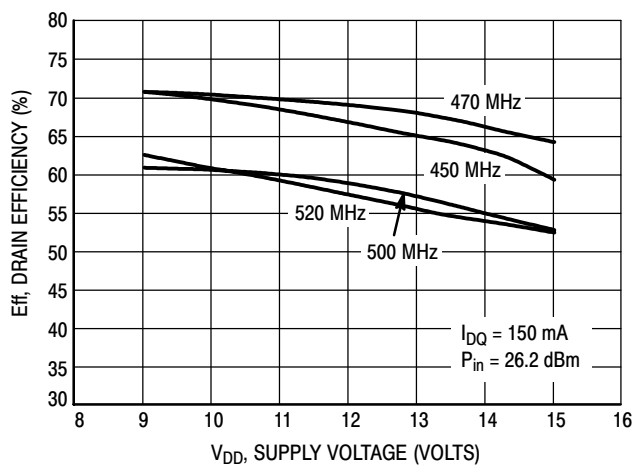
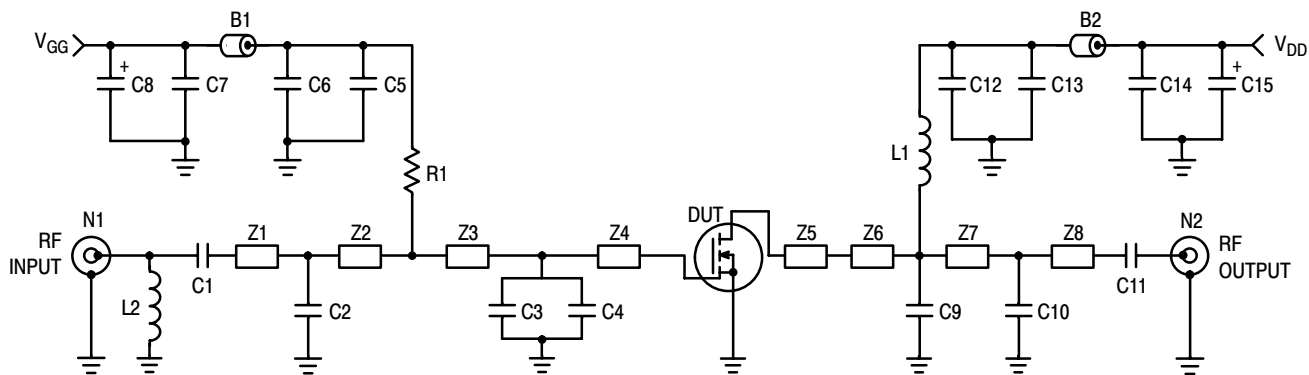

Figure 9. Drain Efficiency versus Supply Voltage



B1, B2	Long Ferrite Beads, Fair Rite Products	N1, N2	Type N Flange Mounts
C1, C9	12 pF, 100 mil Chip Capacitors	R1	47 Ω Chip Resistor (0805)
C2	6.8 pF, 100 mil Chip Capacitor	Z1	1.145" x 0.080" Microstrip
C3, C4	20 pF, 100 mil Chip Capacitors	Z2	0.786" x 0.080" Microstrip
C5	51 pF, 100 mil Chip Capacitor	Z3	0.115" x 0.223" Microstrip
C6, C13	1000 pF, 100 mil Chip Capacitors	Z4	0.145" x 0.223" Microstrip
C7, C14	0.039 μ F, 100 mil Chip Capacitors	Z5	0.260" x 0.223" Microstrip
C8	1 μ F, 20 V Tantalum Chip Capacitor	Z6	0.081" x 0.080" Microstrip
C10	3 pF, 100 mil Chip Capacitor	Z7	0.104" x 0.080" Microstrip
C11, C12	51 pF, 100 mil Chip Capacitors	Z8	1.759" x 0.080" Microstrip
C15	22 μ F, 35 V Tantalum Chip Capacitor	Board	Glass Teflon [®] , 31 mils, 2 oz. Copper
L1, L2	18.5 nH, 5 Turn, Coilcraft		

Figure 10. 820 - 850 MHz Broadband Test Circuit

TYPICAL CHARACTERISTICS, 820 - 850 MHz

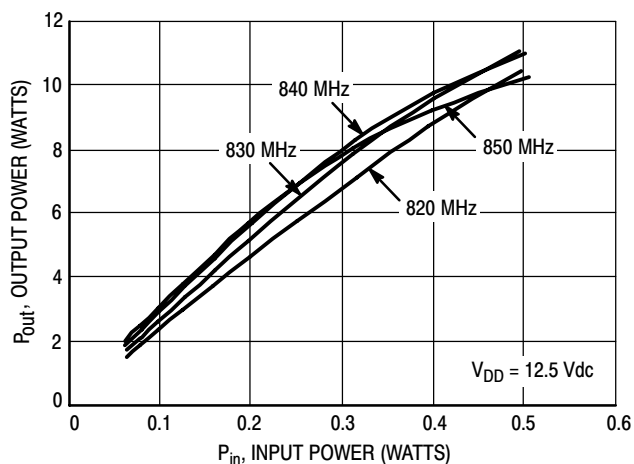

Figure 11. Output Power versus Input Power

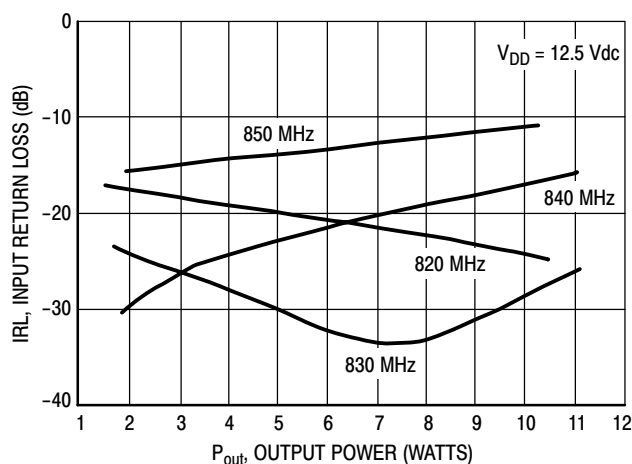

Figure 12. Input Return Loss versus Output Power

TYPICAL CHARACTERISTICS, 820 - 850 MHz

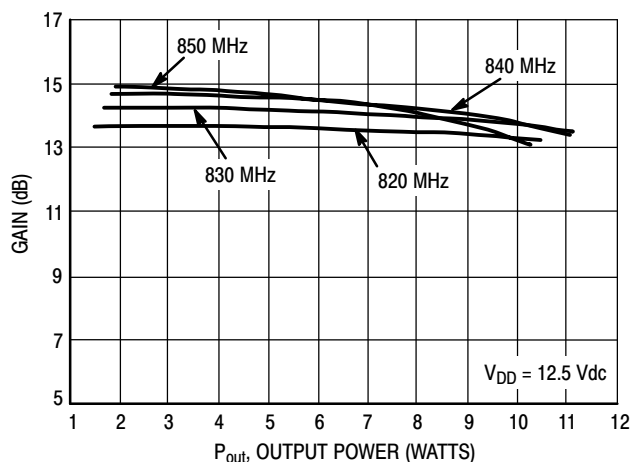

Figure 13. Gain versus Output Power

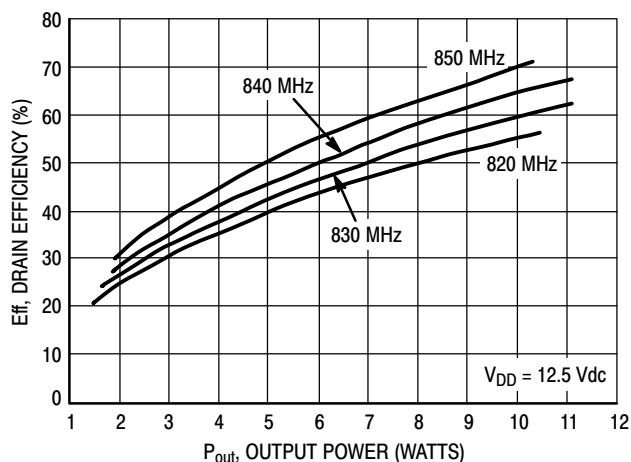

Figure 14. Drain Efficiency versus Output Power

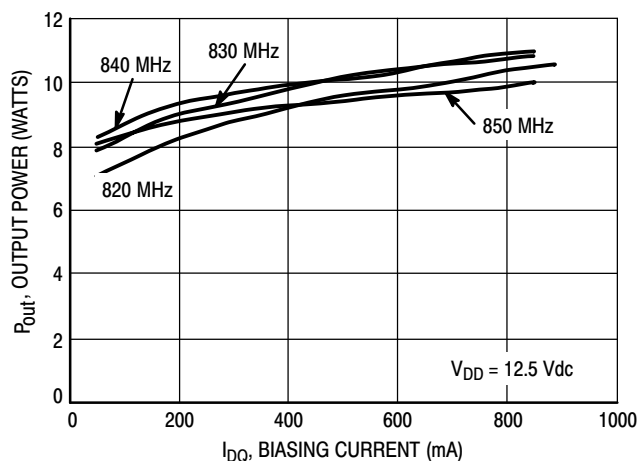

Figure 15. Output Power versus Biasing Current

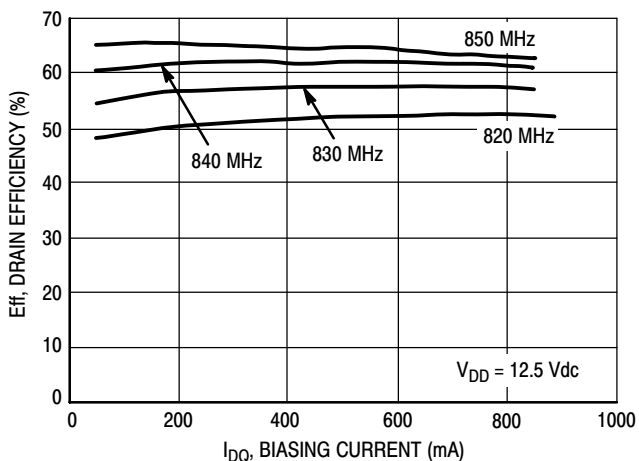

Figure 16. Drain Efficiency versus Biasing Current

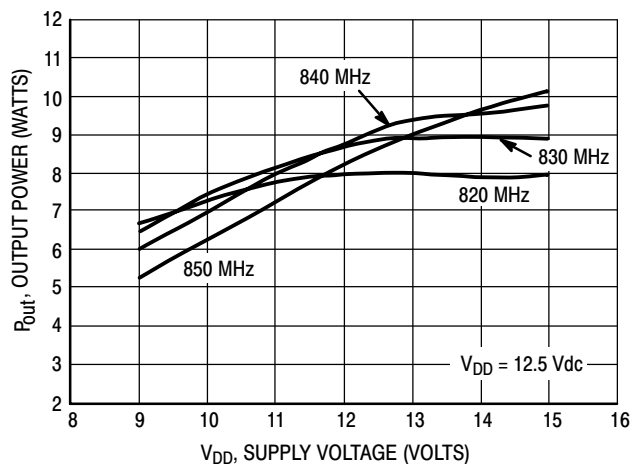

Figure 17. Output Power versus Supply Voltage

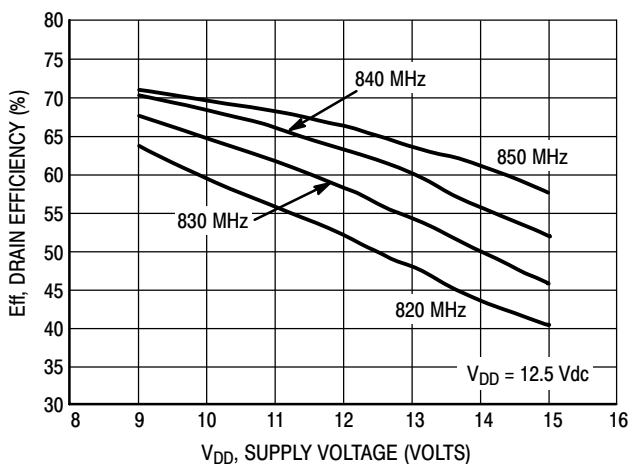
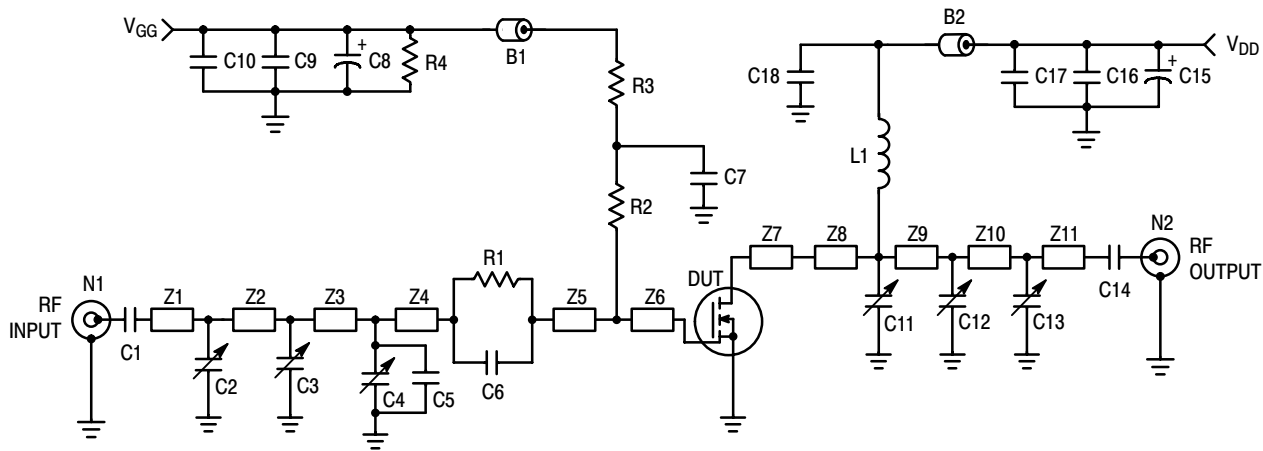

Figure 18. Drain Efficiency versus Supply Voltage



B1, B2	Short Ferrite Beads, Fair Rite Products (2743021446)	R3	10 Ω Chip Resistor (0805)
C1, C14	240 pF, 100 mil Chip Capacitors	R4	33 k Ω , 1/8 W Resistor
C2, C3, C4, C11, C12, C13	0 to 20 pF Trimmer Capacitors	Z1	0.476" x 0.080" Microstrip
C5	30 pF, 100 mil Chip Capacitor	Z2	0.724" x 0.080" Microstrip
C6	47 pF, 100 mil Chip Capacitor	Z3	0.348" x 0.080" Microstrip
C7, C18	120 pF, 100 mil Chip Capacitors	Z4	0.048" x 0.080" Microstrip
C8, C15	10 μ F, 50 V Electrolytic Capacitors	Z5	0.175" x 0.080" Microstrip
C9, C16	1,200 pF, 100 mil Chip Capacitors	Z6, Z7	0.260" x 0.223" Microstrip
C10, C17	0.1 μ F, 100 mil Chip Capacitors	Z8	0.239" x 0.080" Microstrip
L1	55.5 nH, 5 Turn, Coilcraft	Z9	0.286" x 0.080" Microstrip
N1, N2	Type N Flange Mounts	Z10	0.806" x 0.080" Microstrip
R1	15 Ω Chip Resistor (0805)	Z11	0.553" x 0.080" Microstrip
R2	51 Ω , 1/2 W Resistor	Board	Glass Teflon [®] , 31 mils, 2 oz. Copper

Figure 19. 400 - 470 MHz Broadband Test Circuit

TYPICAL CHARACTERISTICS, 400 - 470 MHz

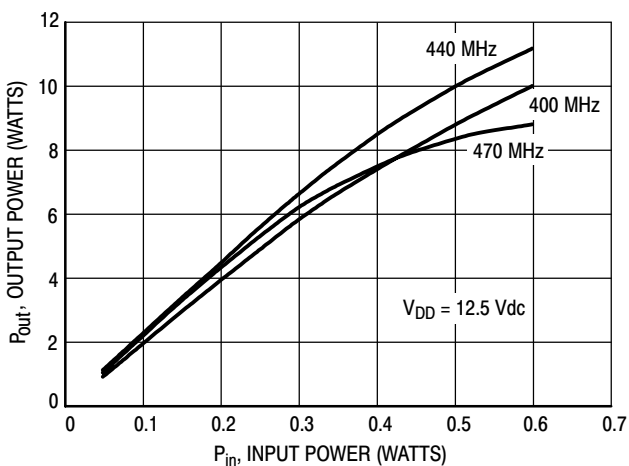

Figure 20. Output Power versus Input Power

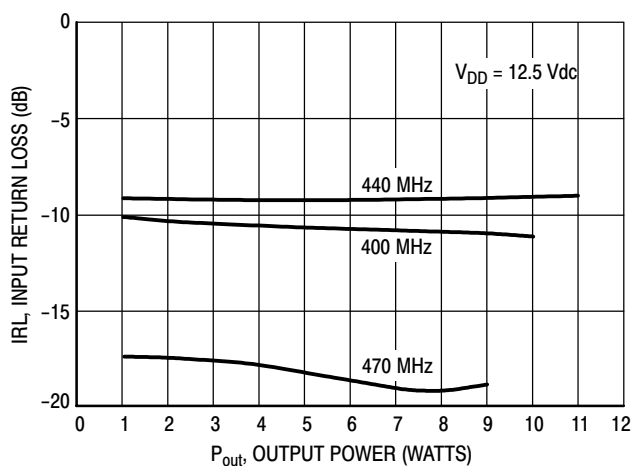

Figure 21. Input Return Loss versus Output Power

TYPICAL CHARACTERISTICS, 400 - 470 MHz

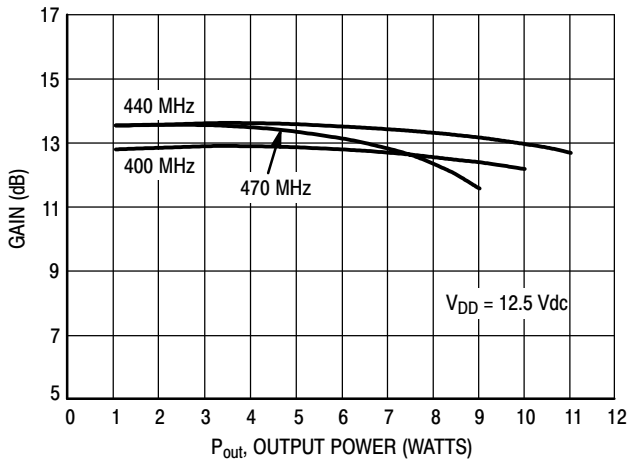

Figure 22. Gain versus Output Power

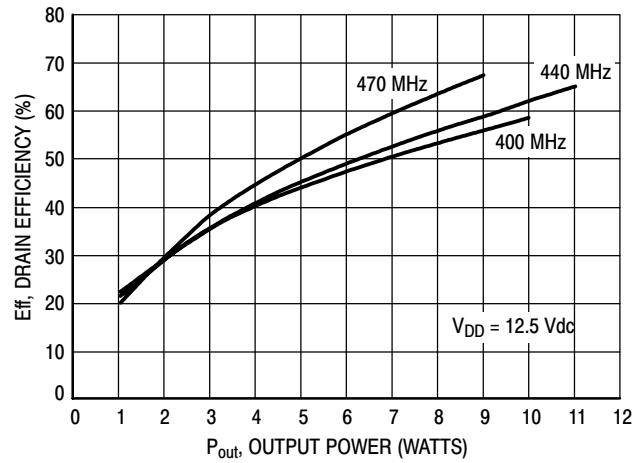

Figure 23. Drain Efficiency versus Output Power

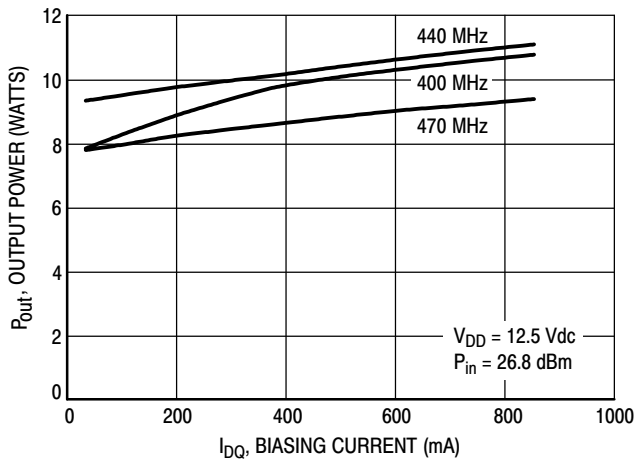

Figure 24. Output Power versus Biasing Current

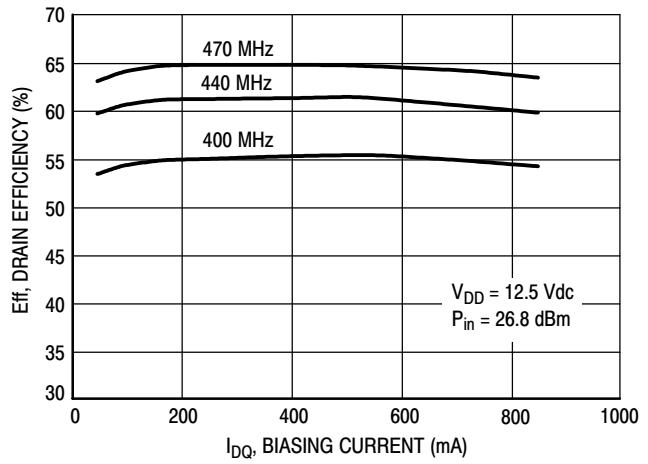

Figure 25. Drain Efficiency versus Biasing Current

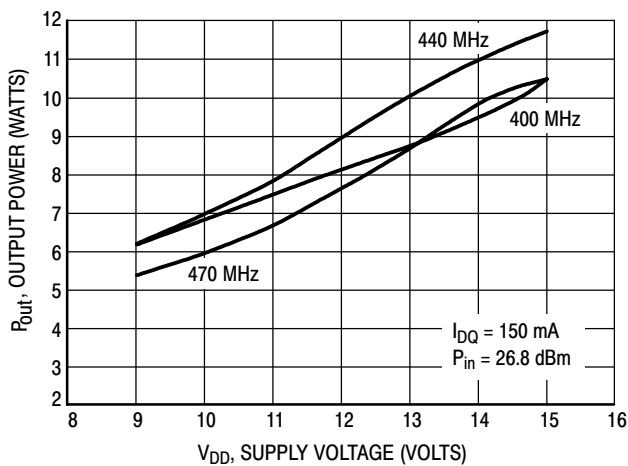

Figure 26. Output Power versus Supply Voltage

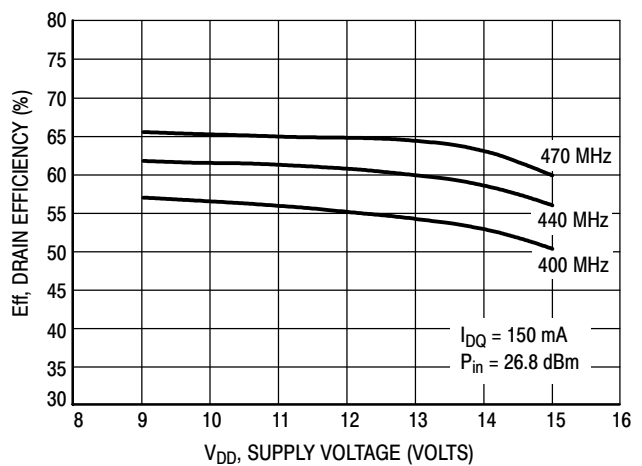
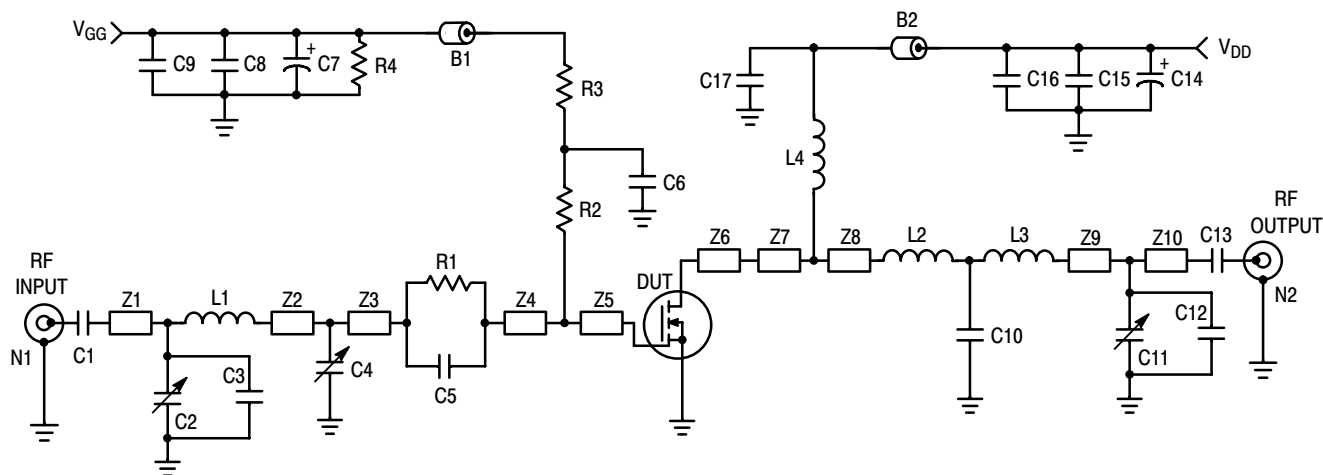

Figure 27. Drain Efficiency versus Supply Voltage



B1, B2	Short Ferrite Beads, Fair Rite Products (2743021446)	L4	55.5 nH, 5 Turn, Coilcraft
C1, C13	330 pF, 100 mil Chip Capacitors	N1, N2	Type N Flange Mounts
C2, C4, C11	0 to 20 pF Trimmer Capacitors	R1	15 Ω Chip Resistor (0805)
C3	12 pF, 100 mil Chip Capacitor	R2	56 Ω , 1/4 W Carbon Resistor
C5	43 pF, 100 mil Chip Capacitor	R3	100 Ω Chip Resistor (0805)
C6, C17	75 pF, 100 mil Chip Capacitors	R4	33 k Ω , 1/8 W Carbon Resistor
C7, C14	10 μ F, 50 V Electrolytic Capacitors	Z1	0.115" x 0.080" Microstrip
C8, C15	1,200 pF, 100 mil Chip Capacitors	Z2	0.255" x 0.080" Microstrip
C9, C16	0.1 μ F, 100 mil Chip Capacitors	Z3	1.037" x 0.080" Microstrip
C10	75 pF, 100 mil Chip Capacitor	Z4	0.192" x 0.080" Microstrip
C12	13 pF, 100 mil Chip Capacitor	Z5, Z6	0.260" x 0.223" Microstrip
L1	26 nH, 4 Turn, Coilcraft	Z7	0.125" x 0.080" Microstrip
L2	5 nH, 2 Turn, Coilcraft	Z8	0.962" x 0.080" Microstrip
L3	33 nH, 5 Turn, Coilcraft	Z9	0.305" x 0.080" Microstrip
		Z10	0.155" x 0.080" Microstrip
		Board	Glass Teflon [®] , 31 mils, 2 oz. Copper

Figure 28. 135 - 175 MHz Broadband Test Circuit

TYPICAL CHARACTERISTICS, 135 - 175 MHz

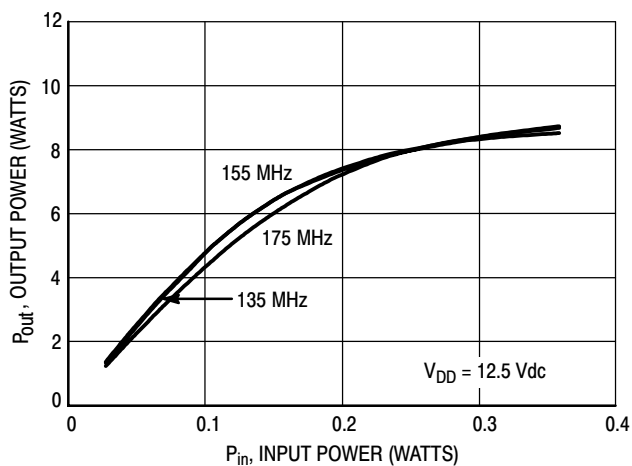

Figure 29. Output Power versus Input Power

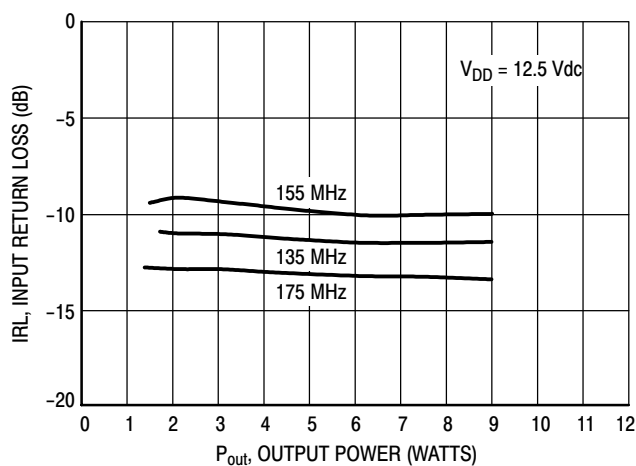

Figure 30. Input Return Loss versus Output Power

TYPICAL CHARACTERISTICS, 135 - 175 MHz

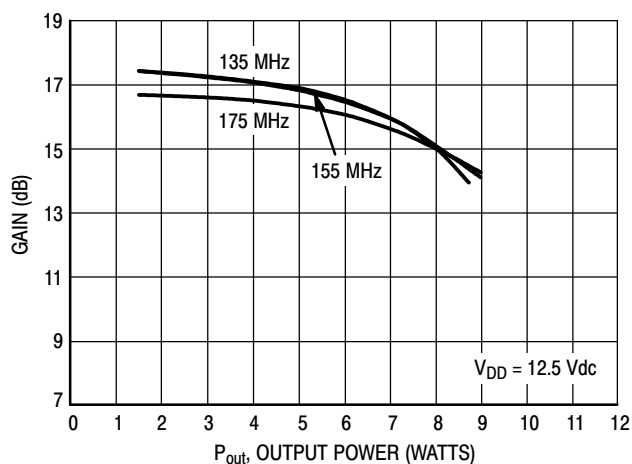

Figure 31. Gain versus Output Power

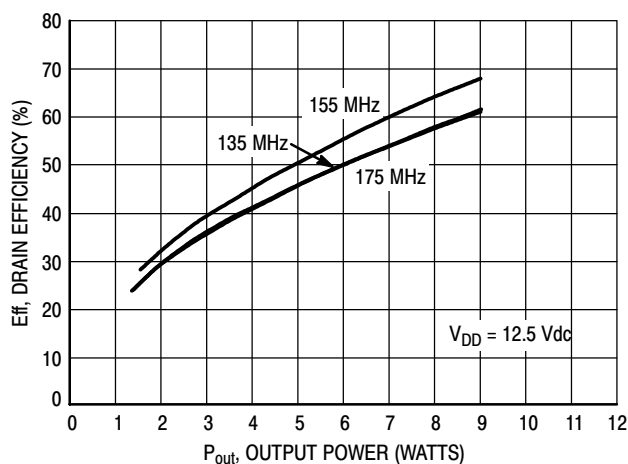

Figure 32. Drain Efficiency versus Output Power

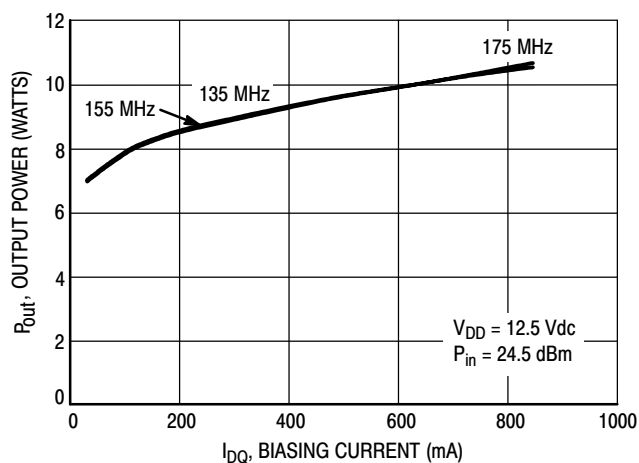

Figure 33. Output Power versus Biasing Current

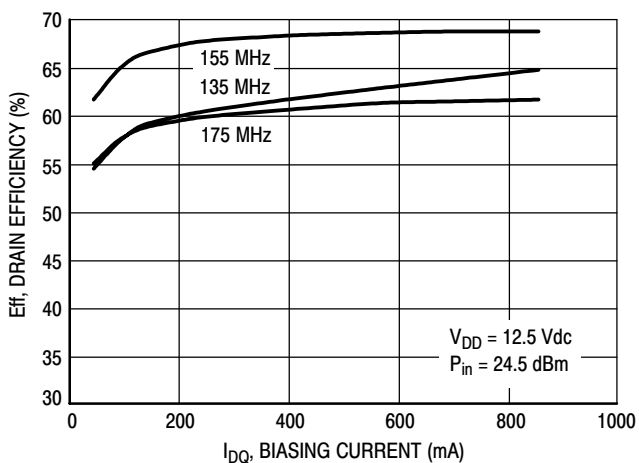

Figure 34. Drain Efficiency versus Biasing Current

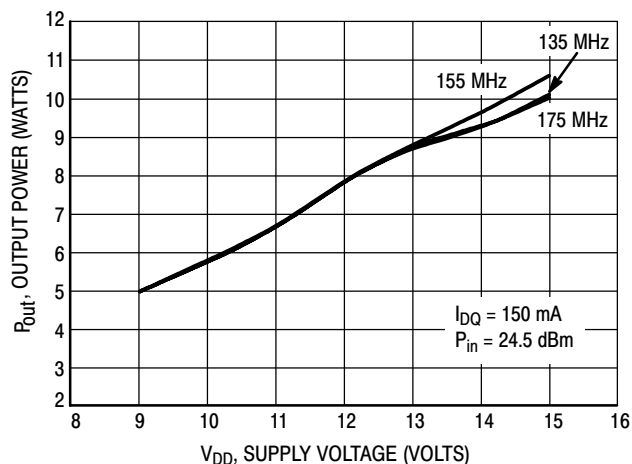

Figure 35. Output Power versus Supply Voltage

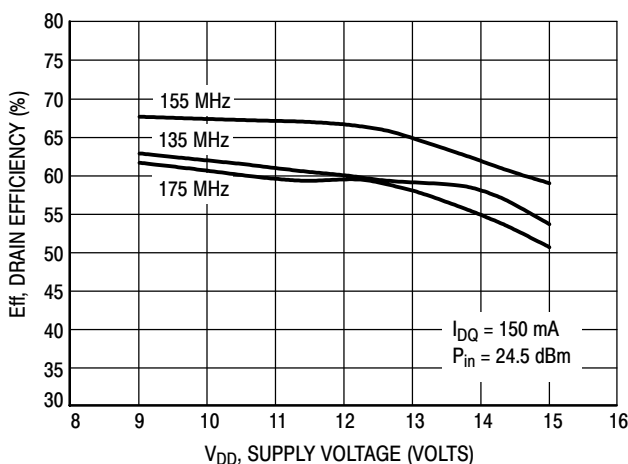
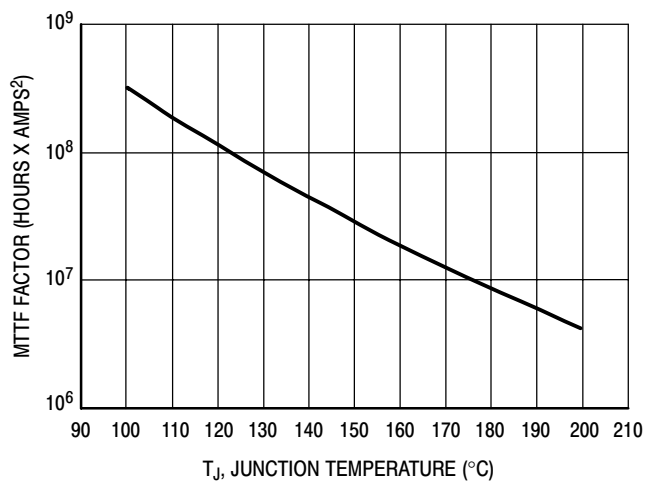

Figure 36. Drain Efficiency versus Supply Voltage

TYPICAL CHARACTERISTICS



This above graph displays calculated MTTF in hours x ampere² drain current. Life tests at elevated temperatures have correlated to better than ±10% of the theoretical prediction for metal failure. Divide MTTF factor by I_D^2 for MTTF in a particular application.

Figure 37. MTTF Factor versus Junction Temperature

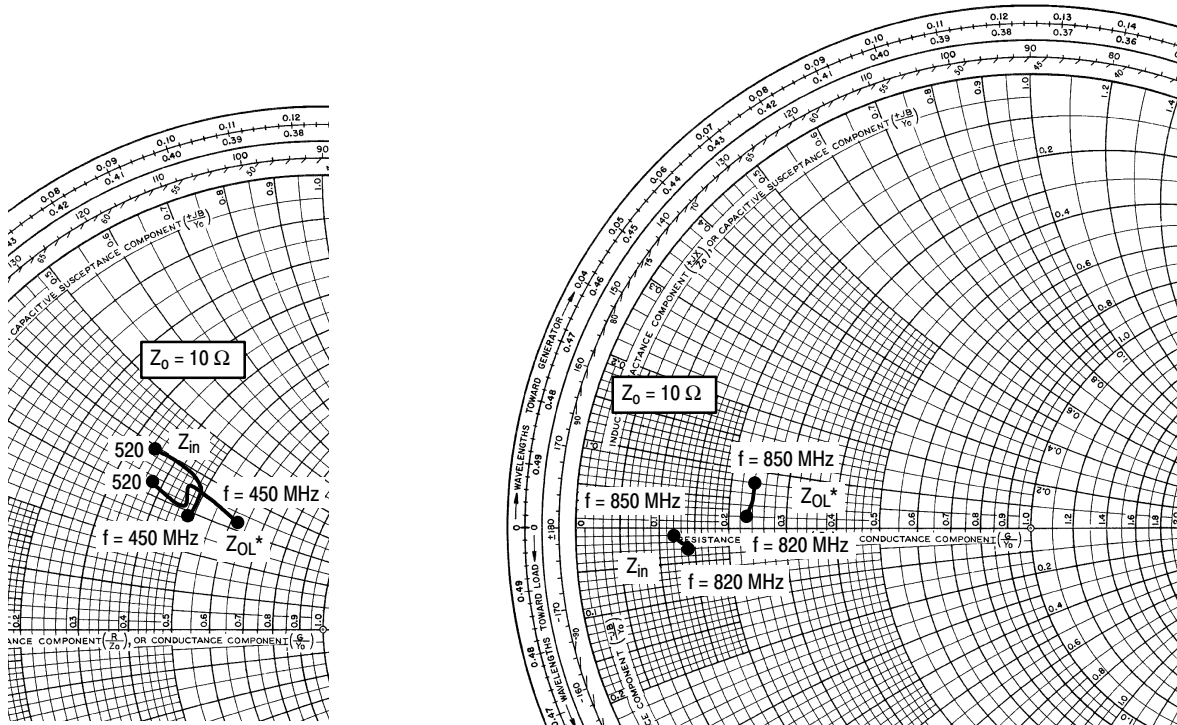

$V_{DD} = 12.5\text{ V}$, $I_{DQ} = 150\text{ mA}$, $P_{out} = 8\text{ W}$

f MHz	Z_{in} Ω	Z_{OL}^* Ω
450	$4.9 + j2.85$	$6.42 + j3.23$
470	$4.85 + j3.71$	$4.59 + j3.61$
500	$4.63 + j3.84$	$4.72 + j3.12$
520	$3.52 + j3.92$	$3.81 + j3.27$

Z_{in} = Complex conjugate of source impedance with parallel 15 Ω resistor and 82 pF capacitor in series with gate. (See Figure 1).

Z_{OL}^* = Complex conjugate of the load impedance at given output power, voltage, frequency, and $\eta_D > 50\%$.

$V_{DD} = 12.5\text{ V}$, $I_{DQ} = 150\text{ mA}$, $P_{out} = 8\text{ W}$

f MHz	Z_{in} Ω	Z_{OL}^* Ω
820	$1.42 - j0.32$	$2.34 + j0.23$
830	$1.39 - j0.21$	$2.36 + j0.47$
840	$1.32 - j0.16$	$2.40 + j0.69$
850	$1.23 - j0.13$	$2.37 + j0.79$

Z_{in} = Complex conjugate of source impedance.

Z_{OL}^* = Complex conjugate of the load impedance at given output power, voltage, frequency, and $\eta_D > 50\%$.

Note: Z_{OL}^* was chosen based on tradeoffs between gain, drain efficiency, and device stability.

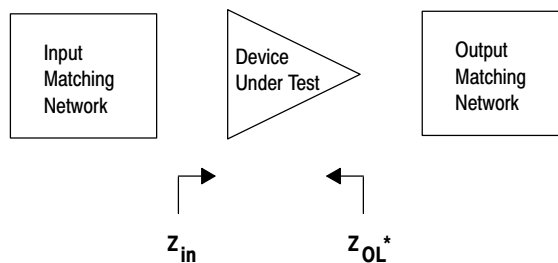
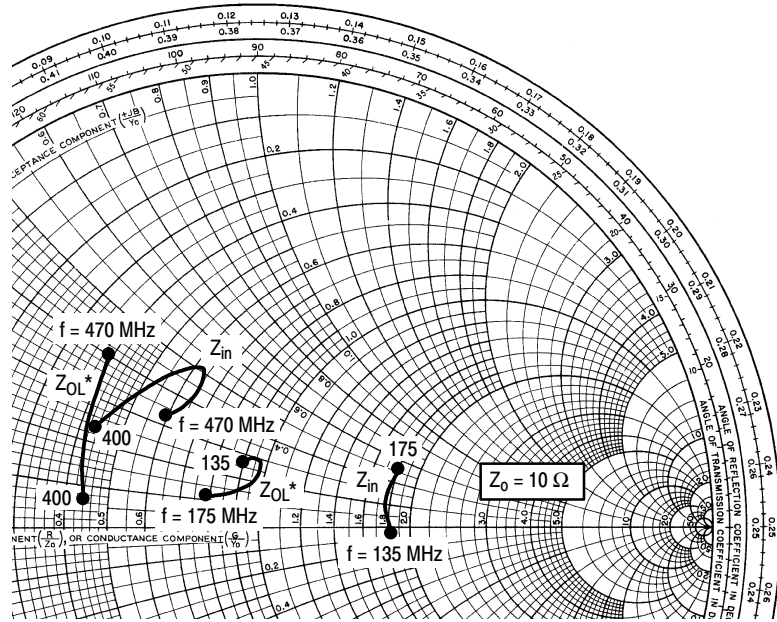

Figure 38. Series Equivalent Input and Output Impedance



$V_{DD} = 12.5\text{ V}$, $I_{DQ} = 150\text{ mA}$, $P_{out} = 8\text{ W}$

f MHz	Z_{in} Ω	Z_{OL}^* Ω
400	$4.28 + j2.36$	$4.41 + j0.67$
440	$6.45 + j5.13$	$4.14 + j2.53$
470	$5.91 + j3.34$	$3.92 + j4.02$

$V_{DD} = 12.5\text{ V}$, $I_{DQ} = 150\text{ mA}$, $P_{out} = 8\text{ W}$

f MHz	Z_{in} Ω	Z_{OL}^* Ω
135	$18.31 - j0.76$	$8.97 + j2.62$
155	$17.72 + j1.85$	$9.69 + j2.81$
175	$18.06 + j5.23$	$7.94 + j1.14$

Z_{in} = Complex conjugate of source impedance with parallel $15\ \Omega$ resistor and 47 pF capacitor in series with gate. (See Figure 19).

Z_{OL}^* = Complex conjugate of the load impedance at given output power, voltage, frequency, and $\eta_D > 50\%$.

Z_{in} = Complex conjugate of source impedance with parallel $15\ \Omega$ resistor and 43 pF capacitor in series with gate. (See Figure 28).

Z_{OL}^* = Complex conjugate of the load impedance at given output power, voltage, frequency, and $\eta_D > 50\%$.

Note: Z_{OL}^* was chosen based on tradeoffs between gain, drain efficiency, and device stability.

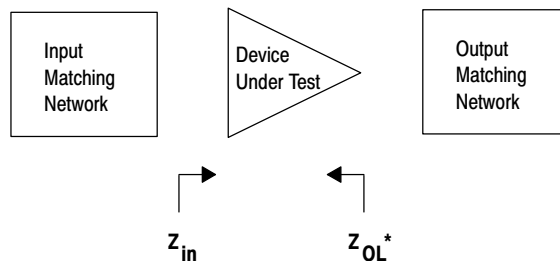

Figure 38. Series Equivalent Input and Output Impedance (continued)

Table 5. Common Source Scattering Parameters ($V_{DD} = 12.5$ Vdc)

$I_{DQ} = 150$ mA

f MHz	S ₁₁		S ₂₁		S ₁₂		S ₂₂	
	S ₁₁	∠φ	S ₂₁	∠φ	S ₁₂	∠φ	S ₂₂	∠φ
50	0.88	-148	18.91	99	0.033	11	0.67	-144
100	0.85	-163	9.40	86	0.033	-6	0.66	-158
200	0.85	-170	4.47	73	0.026	-17	0.69	-162
300	0.87	-171	2.72	64	0.025	-28	0.74	-163
400	0.88	-172	1.85	56	0.021	-21	0.79	-164
500	0.90	-173	1.35	52	0.019	-30	0.83	-165
600	0.92	-173	1.04	47	0.014	-26	0.85	-167
700	0.93	-174	0.83	44	0.015	-39	0.88	-168
800	0.94	-175	0.68	39	0.014	-31	0.90	-169
900	0.94	-175	0.55	36	0.010	-41	0.91	-170
1000	0.96	-176	0.46	30	0.011	-38	0.95	-170

$I_{DQ} = 800$ mA

f MHz	S ₁₁		S ₂₁		S ₁₂		S ₂₂	
	S ₁₁	∠φ	S ₂₁	∠φ	S ₁₂	∠φ	S ₂₂	∠φ
50	0.90	-159	20.80	97	0.020	14	0.73	-162
100	0.88	-169	10.35	88	0.018	1	0.74	-169
200	0.88	-174	5.09	79	0.017	-9	0.75	-171
300	0.89	-175	3.23	73	0.015	-18	0.77	-171
400	0.89	-175	2.30	67	0.015	-17	0.80	-171
500	0.90	-176	1.74	63	0.014	-22	0.82	-170
600	0.91	-176	1.39	59	0.014	-19	0.83	-171
700	0.92	-176	1.16	55	0.009	-23	0.85	-171
800	0.93	-176	0.96	50	0.011	-14	0.87	-172
900	0.94	-177	0.80	46	0.007	4	0.88	-173
1000	0.94	-177	0.67	41	0.010	-15	0.89	-173

$I_{DQ} = 1.5$ A

f MHz	S ₁₁		S ₂₁		S ₁₂		S ₂₂	
	S ₁₁	∠φ	S ₂₁	∠φ	S ₁₂	∠φ	S ₂₂	∠φ
50	0.91	-159	20.18	97	0.015	11	0.73	-165
100	0.89	-169	10.05	89	0.016	-5	0.74	-171
200	0.88	-174	4.93	80	0.015	-3	0.75	-172
300	0.89	-175	3.14	73	0.014	-14	0.78	-172
400	0.89	-176	2.24	67	0.014	-20	0.80	-171
500	0.90	-176	1.70	64	0.014	-22	0.82	-170
600	0.92	-176	1.36	59	0.010	-16	0.84	-171
700	0.92	-176	1.13	55	0.013	-10	0.85	-171
800	0.93	-177	0.94	50	0.008	-13	0.87	-172
900	0.94	-177	0.78	46	0.013	-26	0.87	-173
1000	0.94	-178	0.65	41	0.007	8	0.87	-172

DESIGN CONSIDERATIONS

This device is a common-source, RF power, N-Channel enhancement mode, Lateral Metal-Oxide Semiconductor Field-Effect Transistor (MOSFET). Freescale Application Note AN211A, "FETs in Theory and Practice", is suggested reading for those not familiar with the construction and characteristics of FETs.

This surface mount packaged device was designed primarily for VHF and UHF portable power amplifier applications. Manufacturability is improved by utilizing the tape and reel capability for fully automated pick and placement of parts. However, care should be taken in the design process to insure proper heat sinking of the device.

The major advantages of Lateral RF power MOSFETs include high gain, simple bias systems, relative immunity from thermal runaway, and the ability to withstand severely mismatched loads without suffering damage.

MOSFET CAPACITANCES

The physical structure of a MOSFET results in capacitors between all three terminals. The metal oxide gate structure determines the capacitors from gate-to-drain (C_{gd}), and gate-to-source (C_{gs}). The PN junction formed during fabrication of the RF MOSFET results in a junction capacitance from drain-to-source (C_{ds}). These capacitances are characterized as input (C_{iss}), output (C_{oss}) and reverse transfer (C_{rss}) capacitances on data sheets. The relationships between the inter-terminal capacitances and those given on data sheets are shown below. The C_{iss} can be specified in two ways:

1. Drain shorted to source and positive voltage at the gate.
2. Positive voltage of the drain in respect to source and zero volts at the gate.

In the latter case, the numbers are lower. However, neither method represents the actual operating conditions in RF applications.

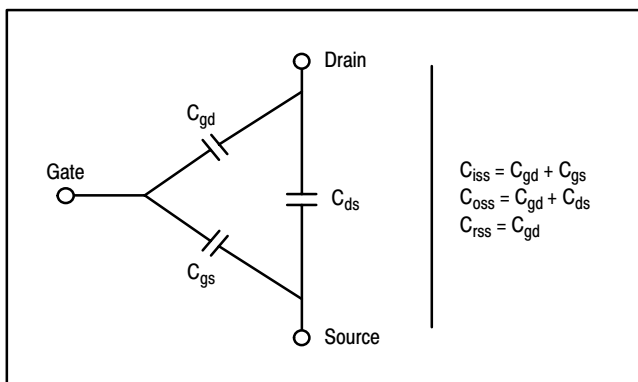

DRAIN CHARACTERISTICS

One critical figure of merit for a FET is its static resistance in the full-on condition. This on-resistance, $R_{DS(on)}$, occurs in the linear region of the output characteristic and is specified at a specific gate-source voltage and drain current. The

drain-source voltage under these conditions is termed $V_{DS(on)}$. For MOSFETs, $V_{DS(on)}$ has a positive temperature coefficient at high temperatures because it contributes to the power dissipation within the device.

BV_{DSS} values for this device are higher than normally required for typical applications. Measurement of BV_{DSS} is not recommended and may result in possible damage to the device.

GATE CHARACTERISTICS

The gate of the RF MOSFET is a polysilicon material, and is electrically isolated from the source by a layer of oxide. The DC input resistance is very high - on the order of $10^9 \Omega$ — resulting in a leakage current of a few nanoamperes.

Gate control is achieved by applying a positive voltage to the gate greater than the gate-to-source threshold voltage, $V_{GS(th)}$.

Gate Voltage Rating — Never exceed the gate voltage rating. Exceeding the rated V_{GS} can result in permanent damage to the oxide layer in the gate region.

Gate Termination — The gates of these devices are essentially capacitors. Circuits that leave the gate open-circuited or floating should be avoided. These conditions can result in turn-on of the devices due to voltage build-up on the input capacitor due to leakage currents or pickup.

Gate Protection — These devices do not have an internal monolithic zener diode from gate-to-source. If gate protection is required, an external zener diode is recommended. Using a resistor to keep the gate-to-source impedance low also helps dampen transients and serves another important function. Voltage transients on the drain can be coupled to the gate through the parasitic gate-drain capacitance. If the gate-to-source impedance and the rate of voltage change on the drain are both high, then the signal coupled to the gate may be large enough to exceed the gate-threshold voltage and turn the device on.

DC BIAS

Since this device is an enhancement mode FET, drain current flows only when the gate is at a higher potential than the source. RF power FETs operate optimally with a quiescent drain current (I_{DQ}), whose value is application dependent. This device was characterized at $I_{DQ} = 150 \text{ mA}$, which is the suggested value of bias current for typical applications. For special applications such as linear amplification, I_{DQ} may have to be selected to optimize the critical parameters.

The gate is a dc open circuit and draws no current. Therefore, the gate bias circuit may generally be just a simple resistive divider network. Some special applications may require a more elaborate bias system.

GAIN CONTROL

Power output of this device may be controlled to some degree with a low power dc control signal applied to the gate, thus facilitating applications such as manual gain control, ALC/AGC and modulation systems. This characteristic is very dependent on frequency and load line.

MOUNTING

The specified maximum thermal resistance of 2°C/W assumes a majority of the 0.065" x 0.180" source contact on the back side of the package is in good contact with an appropriate heat sink. As with all RF power devices, the goal of the thermal design should be to minimize the temperature at the back side of the package. Refer to Freescale Application Note AN4005/D, "Thermal Management and Mounting Method for the PLD-1.5 RF Power Surface Mount Package," and Engineering Bulletin EB209/D, "Mounting Method for RF Power Leadless Surface Mount Transistor" for additional information.

AMPLIFIER DESIGN

Impedance matching networks similar to those used with bipolar transistors are suitable for this device. For examples see Freescale Application Note AN721, "Impedance Matching Networks Applied to RF Power Transistors."

Large-signal impedances are provided, and will yield a good first pass approximation.

Since RF power MOSFETs are triode devices, they are not unilateral. This coupled with the very high gain of this device yields a device capable of self oscillation. Stability may be achieved by techniques such as drain loading, input shunt resistive loading, or output to input feedback. The RF test fixture implements a parallel resistor and capacitor in series with the gate, and has a load line selected for a higher efficiency, lower gain, and more stable operating region.

Two-port stability analysis with this device's S-parameters provides a useful tool for selection of loading or feedback circuitry to assure stable operation. See Freescale Application Note AN215A, "RF Small-Signal Design Using Two-Port Parameters" for a discussion of two port network theory and stability.

PACKAGE DIMENSIONS

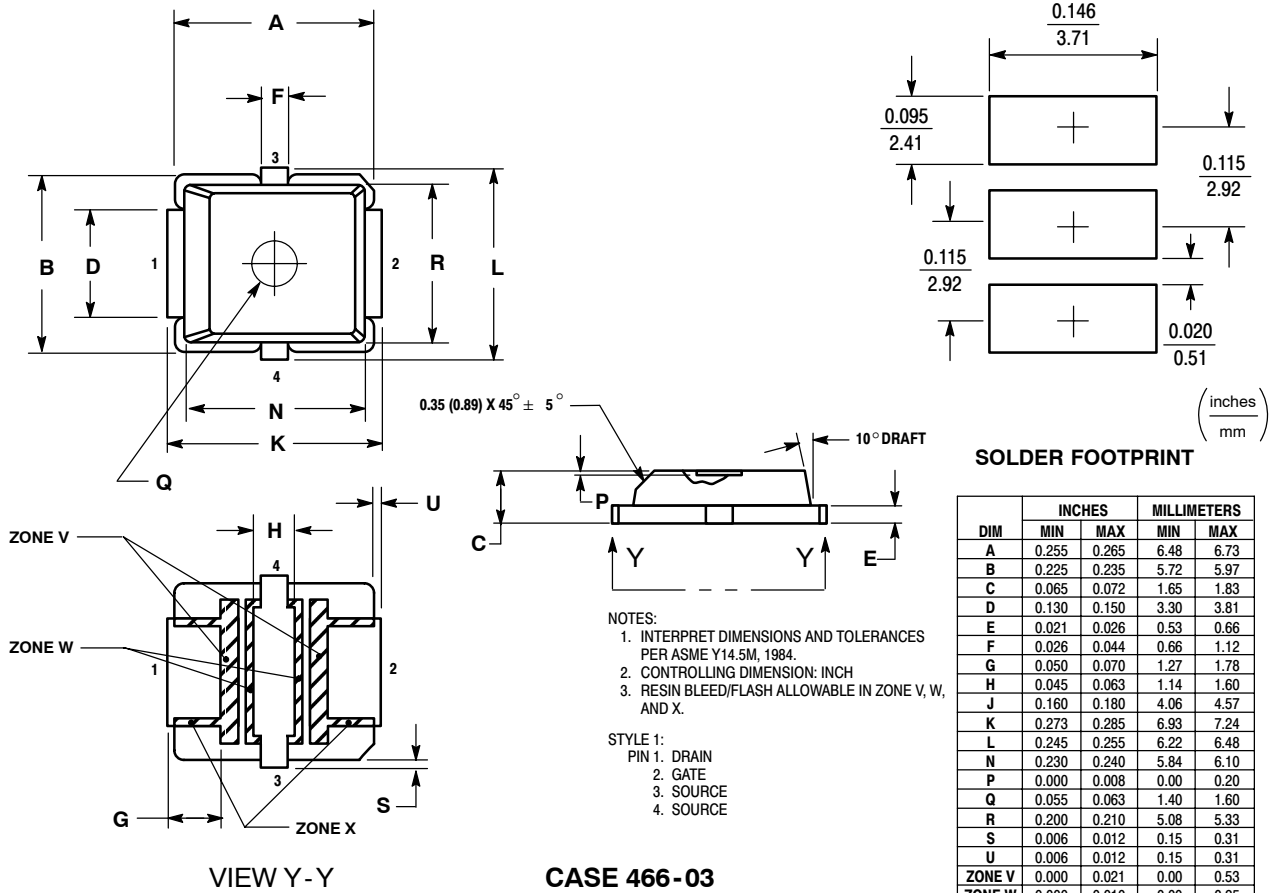

**CASE 466-03
 ISSUE D
 PLD-1.5
 PLASTIC**

PRODUCT DOCUMENTATION, TOOLS AND SOFTWARE

Refer to the following documents to aid your design process.

Application Notes

- AN211A: Field Effect Transistors in Theory and Practice
- AN215A: RF Small-Signal Design Using Two-Port Parameters
- AN721: Impedance Matching Networks Applied to RF Power Transistors
- AN4005: Thermal Management and Mounting Method for the PLD 1.5 RF Power Surface Mount Package

Engineering Bulletins

- EB212: Using Data Sheet Impedances for RF LDMOS Devices

Software

- Electromigration MTTF Calculator

For Software and Tools, do a Part Number search at <http://www.freescale.com>, and select the “Part Number” link. Go to the Software & Tools tab on the part’s Product Summary page to download the respective tool.

REVISION HISTORY

The following table summarizes revisions to this document.

Revision	Date	Description
10	June 2008	<ul style="list-style-type: none"> • Changed Power Gain from 13.5 dB to 13 dB in Functional Tests table on p. 2 and corrected specified performance values for power gain and efficiency on p. 1 to match typical performance values in the functional test. Past two years of production data shows Power Gain typical value at 13 dB. • Added Product Documentation and Revision History, p. 18
11	June 2009	<ul style="list-style-type: none"> • Modified data sheet to reflect MSL rating change from 1 to 3 as a result of the standardization of packing process as described in Product and Process Change Notification number, PCN13516, p. 1 • Added Electromigration MTTF Calculator availability to Product Documentation, Tools and Software, p. 18

How to Reach Us:

Home Page:

www.freescale.com

Web Support:

<http://www.freescale.com/support>

USA/Europe or Locations Not Listed:

Freescale Semiconductor, Inc.
Technical Information Center, EL516
2100 East Elliot Road
Tempe, Arizona 85284
1-800-521-6274 or +1-480-768-2130
www.freescale.com/support

Europe, Middle East, and Africa:

Freescale Halbleiter Deutschland GmbH
Technical Information Center
Schatzbogen 7
81829 Muenchen, Germany
+44 1296 380 456 (English)
+46 8 52200080 (English)
+49 89 92103 559 (German)
+33 1 69 35 48 48 (French)
www.freescale.com/support

Japan:

Freescale Semiconductor Japan Ltd.
Headquarters
ARCO Tower 15F
1-8-1, Shimo-Meguro, Meguro-ku,
Tokyo 153-0064
Japan
0120 191014 or +81 3 5437 9125
support.japan@freescale.com

Asia/Pacific:

Freescale Semiconductor China Ltd.
Exchange Building 23F
No. 118 Jianguo Road
Chaoyang District
Beijing 100022
China
+86 10 5879 8000
support.asia@freescale.com

For Literature Requests Only:

Freescale Semiconductor Literature Distribution Center
1-800-441-2447 or +1-303-675-2140
Fax: +1-303-675-2150
LDCForFreescaleSemiconductor@hibbertgroup.com

Information in this document is provided solely to enable system and software implementers to use Freescale Semiconductor products. There are no express or implied copyright licenses granted hereunder to design or fabricate any integrated circuits or integrated circuits based on the information in this document.

Freescale Semiconductor reserves the right to make changes without further notice to any products herein. Freescale Semiconductor makes no warranty, representation or guarantee regarding the suitability of its products for any particular purpose, nor does Freescale Semiconductor assume any liability arising out of the application or use of any product or circuit, and specifically disclaims any and all liability, including without limitation consequential or incidental damages. "Typical" parameters that may be provided in Freescale Semiconductor data sheets and/or specifications can and do vary in different applications and actual performance may vary over time. All operating parameters, including "Typicals", must be validated for each customer application by customer's technical experts. Freescale Semiconductor does not convey any license under its patent rights nor the rights of others. Freescale Semiconductor products are not designed, intended, or authorized for use as components in systems intended for surgical implant into the body, or other applications intended to support or sustain life, or for any other application in which the failure of the Freescale Semiconductor product could create a situation where personal injury or death may occur. Should Buyer purchase or use Freescale Semiconductor products for any such unintended or unauthorized application, Buyer shall indemnify and hold Freescale Semiconductor and its officers, employees, subsidiaries, affiliates, and distributors harmless against all claims, costs, damages, and expenses, and reasonable attorney fees arising out of, directly or indirectly, any claim of personal injury or death associated with such unintended or unauthorized use, even if such claim alleges that Freescale Semiconductor was negligent regarding the design or manufacture of the part.

Freescale™ and the Freescale logo are trademarks of Freescale Semiconductor, Inc. All other product or service names are the property of their respective owners.

© Freescale Semiconductor, Inc. 2008-2009. All rights reserved.

RoHS-compliant and/or Pb-free versions of Freescale products have the functionality and electrical characteristics of their non-RoHS-compliant and/or non-Pb-free counterparts. For further information, see <http://www.freescale.com> or contact your Freescale sales representative.

For information on Freescale's Environmental Products program, go to <http://www.freescale.com/epp>.

Компания «Life Electronics» занимается поставками электронных компонентов импортного и отечественного производства от производителей и со складов крупных дистрибьюторов Европы, Америки и Азии.

С конца 2013 года компания активно расширяет линейку поставок компонентов по направлению коаксиальный кабель, кварцевые генераторы и конденсаторы (керамические, пленочные, электролитические), за счёт заключения дистрибьюторских договоров

Мы предлагаем:

- Конкурентоспособные цены и скидки постоянным клиентам.
- Специальные условия для постоянных клиентов.
- Подбор аналогов.
- Поставку компонентов в любых объемах, удовлетворяющих вашим потребностям.
- Приемлемые сроки поставки, возможна ускоренная поставка.
- Доставку товара в любую точку России и стран СНГ.
- Комплексную поставку.
- Работу по проектам и поставку образцов.
- Формирование склада под заказчика.
- Сертификаты соответствия на поставляемую продукцию (по желанию клиента).
- Тестирование поставляемой продукции.
- Поставку компонентов, требующих военную и космическую приемку.
- Входной контроль качества.
- Наличие сертификата ISO.

В составе нашей компании организован Конструкторский отдел, призванный помогать разработчикам, и инженерам.

Конструкторский отдел помогает осуществить:

- Регистрацию проекта у производителя компонентов.
- Техническую поддержку проекта.
- Защиту от снятия компонента с производства.
- Оценку стоимости проекта по компонентам.
- Изготовление тестовой платы монтаж и пусконаладочные работы.



Тел: +7 (812) 336 43 04 (многоканальный)

Email: org@lifeelectronics.ru