

### FEATURES

- Offset voltage: 2.5 mV max
- Low input bias current: 1 pA max
- Single-supply operation: 5 V to 16 V
- Dual-supply operation:  $\pm 2.5$  V to  $\pm 8$  V
- Low noise: 8 nV/ $\sqrt{\text{Hz}}$  @ 10 kHz
- Wide bandwidth: 4 MHz
- Rail-to-rail output
- Unity-gain stable
- Lead-free packaging
- AD8666/AD8668 qualified for automotive applications

### APPLICATIONS

- Sensor amplification
- Reference buffers
- Medical equipment
- Physiological measurements
- Signal filters and conditioning
- Consumer audio
- Photodiode amplification
- ADC driver
- Level shifting circuits

### GENERAL DESCRIPTION

The AD866x family is single supply, rail-to-rail output amplifiers with low noise performance featuring an extended operating range with supply voltages up to 16 V. They also feature low input bias currents, wide signal bandwidth, and low input voltage and current noise. For lower offset voltage, choose the AD8661/AD8662/AD8664 family.

The combination of low offsets, very low input bias currents, and wide supply range make these amplifiers useful in a wide variety of cost sensitive applications normally associated with much higher priced JFET amplifiers. Systems using high impedance sensors, such as photo diodes, benefit from the combination of low input bias current, low noise, and low offset and bandwidth. The wide operating voltage range matches high performance ADCs and DACs. Audio applications and medical monitoring equipment can take advantage of the high input impedance, low voltage and current noise, wide bandwidth, and the lack of popcorn noise found in many other low input bias current amplifiers.

The AD866x family is specified over the extended industrial temperature range ( $-40^{\circ}\text{C}$  to  $+125^{\circ}\text{C}$ ). See the Ordering Guide for automotive models.

### PIN CONFIGURATIONS

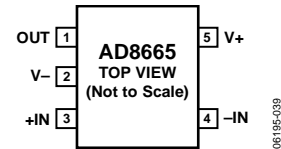

Figure 1. AD8665, 5-Lead SOT-23 (RJ-5)

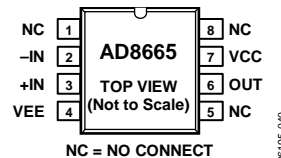

Figure 2. AD8665, 8-Lead SOIC\_N (R-8)

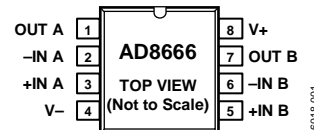

Figure 3. AD8666, 8-Lead SOIC\_N (R-8)



Figure 4. AD8666, 8-Lead MSOP (RM-8)

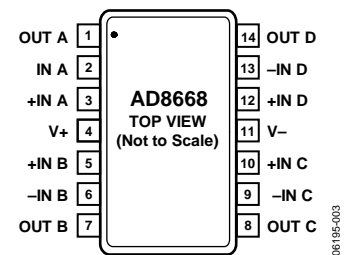

Figure 5. AD8668, 14-Lead TSSOP (RU-14)

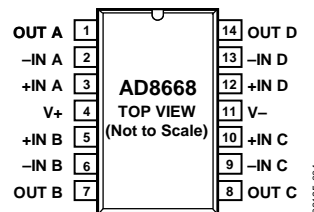

Figure 6. AD8668, 14-Lead SOIC\_N (R-14)

#### Rev. B

Information furnished by Analog Devices is believed to be accurate and reliable. However, no responsibility is assumed by Analog Devices for its use, nor for any infringements of patents or other rights of third parties that may result from its use. Specifications subject to change without notice. No license is granted by implication or otherwise under any patent or patent rights of Analog Devices. Trademarks and registered trademarks are the property of their respective owners.

**TABLE OF CONTENTS**

|                           |   |   |    |
|---------------------------|---|---|----|
| Features .....            | 1 | Absolute Maximum Ratings .....            | 5  |
| Applications.....         | 1 | Thermal Resistance.....                   | 5  |
| General Description ..... | 1 | ESD Caution.....                          | 5  |
| Pin Configurations .....  | 1 | Typical Performance Characteristics ..... | 6  |
| Revision History .....    | 2 | Outline Dimensions .....                  | 12 |
| Specifications.....       | 3 | Ordering Guide .....                      | 14 |

**REVISION HISTORY**

**7/11—Rev. A to Rev. B**

|   |    |
|---|----|
| Change to Features and General Description Sections ..... | 1  |
| Updated Outline Dimensions .....                          | 12 |
| Changes to Ordering Guide .....                           | 13 |
| Added Automotive Products Section.....                    | 13 |

**10/06—Rev. 0 to Rev. A**

|  |           |
|--|-----------|
| Added AD8665 .....   | Universal |
| Added New Figure 1 and Figure 2,<br>Renumbered Sequentially..... | 1         |
| Changes to Table 4.....  | 5         |
| Changes to Figure 8, Figure 9, and Figure 11 .....               | 6         |
| Change to Figure 40 .....  | 11        |
| Updated Outline Dimensions .....                                 | 12        |
| Changes to Ordering Guide .....                                  | 13        |

**4/06—Rev 0: Initial Version**

## SPECIFICATIONS

$V_{DD} = 5.0\text{ V}$ ,  $V_{CM} = V_{DD}/2$ ,  $T_A = 25^\circ\text{C}$ , unless otherwise noted.

Table 1.

| Parameter                    | Symbol                   | Conditions   | Min  | Typ      | Max  | Unit                         |
|------------------------------|--------------------------|--|------|----------|------|------------------------------|
| INPUT CHARACTERISTICS        |                          |  |      |          |      |                              |
| Offset Voltage               | $V_{OS}$                 | $V_{CM} = 2.5\text{ V}$<br>$V_{CM} = -0.1\text{ V to }+3.0\text{ V}$<br>$-40^\circ\text{C} < T_A < +125^\circ\text{C}$ |      | 0.7      | 2.5  | mV                           |
| Offset Voltage Drift         | $\Delta V_{OS}/\Delta T$ | $-40^\circ\text{C} < T_A < +125^\circ\text{C}$   |      | 3.0      | 10   | $\mu\text{V}/^\circ\text{C}$ |
| Input Bias Current           | $I_B$                    | $-40^\circ\text{C} < T_A < +125^\circ\text{C}$   |      | 0.2      | 1    | pA                           |
| Input Offset Current         | $I_{OS}$                 | $-40^\circ\text{C} < T_A < +125^\circ\text{C}$   |      | 0.1      | 0.5  | pA                           |
| Input Voltage Range          | $V_{CM}$                 | $-40^\circ\text{C} < T_A < +125^\circ\text{C}$   | -0.1 |          | +3.0 | V                            |
| Common-Mode Rejection Ratio  | CMRR                     | $V_{CM} = -0.1\text{ V to }+3.0\text{ V}$<br>$-40^\circ\text{C} < T_A < +125^\circ\text{C}$                            | 84   | 100      |      | dB                           |
| Large-Signal Voltage Gain    | $A_{VO}$                 | $R_L = 2\text{ k}\Omega$ , $V_O = 0.5\text{ V to }4.5\text{ V}$  | 68   | 145      |      | V/mV                         |
| OUTPUT CHARACTERISTICS       |                          |  |      |          |      |                              |
| Output Voltage High          | $V_{OH}$                 | $I_{OUT} = 1\text{ mA}$<br>$-40^\circ\text{C} < T_A < +125^\circ\text{C}$  | 4.88 | 4.93     |      | V                            |
| Output Voltage Low           | $V_{OL}$                 | $I_{OUT} = 1\text{ mA}$<br>$-40^\circ\text{C} < T_A < +125^\circ\text{C}$  | 4.86 | 50       | 85   | V                            |
| Short-Circuit Output Current | $I_{SC}$                 |  |      | $\pm 19$ | 105  | mV                           |
| Closed-Loop Output Impedance | $Z_{OUT}$                | At 1 MHz, $A_V = 1$  |      | 50       |      | $\Omega$                     |
| POWER SUPPLY                 |                          |  |      |          |      |                              |
| Power Supply Rejection Ratio | PSRR                     | $V_{DD} = 5.0\text{ V to }16\text{ V}$<br>$-40^\circ\text{C} < T_A < +125^\circ\text{C}$                               | 98   | 115      |      | dB                           |
| Supply Current per Amplifier | $I_{SY}$                 | $-40^\circ\text{C} < T_A < +125^\circ\text{C}$   | 94   | 1.1      | 1.4  | dB                           |
|                              |                          |  |      |          | 2.0  | mA                           |
| DYNAMIC PERFORMANCE          |                          |  |      |          |      |                              |
| Slew Rate                    | SR                       | $R_L = 2\text{ k}\Omega$   |      | 3.5      |      | V/ $\mu\text{s}$             |
| Gain Bandwidth Product       | GBP                      |  |      | 4        |      | MHz                          |
| Phase Margin                 | $\Phi_M$                 |  |      | 70       |      | Degrees                      |
| NOISE PERFORMANCE            |                          |  |      |          |      |                              |
| Peak-to-Peak Noise           | $e_n$ p-p                | 0.1 Hz to 10 Hz  |      | 2.4      |      | $\mu\text{V p-p}$            |
| Voltage Noise Density        | $e_n$                    | $f = 1\text{ kHz}$<br>$f = 10\text{ kHz}$  |      | 10       |      | $\text{nV}/\sqrt{\text{Hz}}$ |
| Channel Separation           | CS                       | $f = 10\text{ kHz}$  |      | -115     |      | dB                           |

# AD8665/AD8666/AD8668

$V_{DD} = 16\text{ V}$ ,  $V_{CM} = V_{DD}/2$ ,  $T_A = 25^\circ\text{C}$ , unless otherwise noted.

**Table 2.**

| Parameter                     | Symbol                   | Conditions  | Min   | Typ       | Max   | Unit                         |
|-------------------------------|--------------------------|---|-------|-----------|-------|------------------------------|
| <b>INPUT CHARACTERISTICS</b>  |                          |   |       |           |       |                              |
| Offset Voltage                | $V_{OS}$                 | $V_{CM} = 8\text{ V}$<br>$V_{CM} = -0.1\text{ V to }+14.0\text{ V}$<br>$-40^\circ\text{C} < T_A < +125^\circ\text{C}$ |       | 0.6       | 2.5   | mV                           |
| Offset Voltage Drift          | $\Delta V_{OS}/\Delta T$ | $-40^\circ\text{C} < T_A < +125^\circ\text{C}$  |       | 3.0       | 10    | $\mu\text{V}/^\circ\text{C}$ |
| Input Bias Current            | $I_B$                    | $-40^\circ\text{C} < T_A < +125^\circ\text{C}$  |       | 0.2       | 1     | pA                           |
| Input Offset Current          | $I_{OS}$                 | $-40^\circ\text{C} < T_A < +125^\circ\text{C}$  |       | 0.1       | 0.5   | pA                           |
| Input Voltage Range           | $V_{CM}$                 | $-40^\circ\text{C} < T_A < +125^\circ\text{C}$  | -0.1  |           | +14.0 | V                            |
| Common-Mode Rejection Ratio   | CMRR                     | $V_{CM} = -0.1\text{ V to }+14.0\text{ V}$<br>$-40^\circ\text{C} < T_A < +125^\circ\text{C}$                          | 90    | 110       |       | dB                           |
| Large-Signal Voltage Gain     | $A_{VO}$                 | $R_L = 2\text{ k}\Omega$ , $V_O = 0.5\text{ V to }15.5\text{ V}$  | 80    | 130       | 255   | dB                           |
| <b>OUTPUT CHARACTERISTICS</b> |                          |   |       |           |       |                              |
| Output Voltage High           | $V_{OH}$                 | $I_{OUT} = 1\text{ mA}$<br>$-40^\circ\text{C} < T_A < +125^\circ\text{C}$   | 15.94 | 15.96     |       | V                            |
| Output Voltage Low            | $V_{OL}$                 | $I_{OUT} = 1\text{ mA}$<br>$-40^\circ\text{C} < T_A < +125^\circ\text{C}$   | 15.90 | 22        | 40    | V                            |
| Short-Circuit Output Current  | $I_{SC}$                 |   |       | $\pm 140$ | 50    | mV                           |
| Closed-Loop Output Impedance  | $Z_{OUT}$                | At 1 MHz, $A_V = 1$   |       | 50        |       | mA                           |
| <b>POWER SUPPLY</b>           |                          |   |       |           |       |                              |
| Power Supply Rejection Ratio  | PSRR                     | $V_{DD} = 5.0\text{ V to }16\text{ V}$<br>$-40^\circ\text{C} < T_A < +125^\circ\text{C}$                              | 98    | 115       |       | dB                           |
| Supply Current per Amplifier  | $I_{SY}$                 | $-40^\circ\text{C} < T_A < +125^\circ\text{C}$  | 94    | 1.15      | 1.55  | dB                           |
| <b>DYNAMIC PERFORMANCE</b>    |                          |   |       |           |       |                              |
| Slew Rate                     | SR                       | $R_L = 2\text{ k}\Omega$  |       | 3.5       |       | $\text{V}/\mu\text{s}$       |
| Gain Bandwidth Product        | GBP                      |   |       | 4         |       | MHz                          |
| Phase Margin                  | $\Phi_M$                 |   |       | 73        |       | Degrees                      |
| <b>NOISE PERFORMANCE</b>      |                          |   |       |           |       |                              |
| Peak-to-Peak Noise            | $e_n\text{ p-p}$         | 0.1 Hz to 10 Hz   |       | 2.5       |       | $\mu\text{V p-p}$            |
| Voltage Noise Density         | $e_n$                    | $f = 1\text{ kHz}$<br>$f = 10\text{ kHz}$   |       | 10        |       | $\text{nV}/\sqrt{\text{Hz}}$ |
| Channel Separation            | CS                       | $f = 10\text{ kHz}$   |       | -115      |       | dB                           |

## ABSOLUTE MAXIMUM RATINGS

Table 3.

| Parameter                            | Rating  |
|--------------------------------------|---|
| Supply Voltage                       | 18 V  |
| Input Voltage                        | GND to $V_{DD}$                                 |
| Differential Input Voltage           | $\pm 18$ V                                      |
| Output Short-Circuit to GND          | Indefinite                                      |
| Storage Temperature Range            | $-65^{\circ}\text{C}$ to $+150^{\circ}\text{C}$ |
| Operating Temperature Range          | $-40^{\circ}\text{C}$ to $+125^{\circ}\text{C}$ |
| Lead Temperature (Soldering, 60 sec) | $300^{\circ}\text{C}$                           |
| Junction Temperature                 | $150^{\circ}\text{C}$                           |

Stresses above those listed under Absolute Maximum Ratings may cause permanent damage to the device. This is a stress rating only; functional operation of the device at these or any other conditions above those indicated in the operational section of this specification is not implied. Exposure to absolute maximum rating conditions for extended periods may affect device reliability.

## THERMAL RESISTANCE

Table 4. Thermal Resistance

| Package Type          | $\theta_{JA}$ | $\theta_{JC}$ | Unit                        |
|-----------------------|---------------|---------------|-----------------------------|
| 5-Lead SOT-23 (RJ-5)  | 240           | 92            | $^{\circ}\text{C}/\text{W}$ |
| 8-Lead SOIC_N (R-8)   | 158           | 43            | $^{\circ}\text{C}/\text{W}$ |
| 8-Lead MSOP (RM-8)    | 210           | 45            | $^{\circ}\text{C}/\text{W}$ |
| 14-Lead SOIC (R-14)   | 120           | 36            | $^{\circ}\text{C}/\text{W}$ |
| 14-Lead TSSOP (RU-14) | 180           | 35            | $^{\circ}\text{C}/\text{W}$ |

## ESD CAUTION



**ESD (electrostatic discharge) sensitive device.** Charged devices and circuit boards can discharge without detection. Although this product features patented or proprietary protection circuitry, damage may occur on devices subjected to high energy ESD. Therefore, proper ESD precautions should be taken to avoid performance degradation or loss of functionality.

## TYPICAL PERFORMANCE CHARACTERISTICS

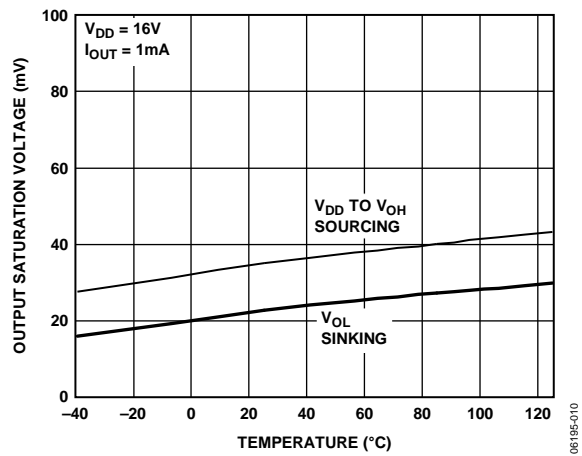
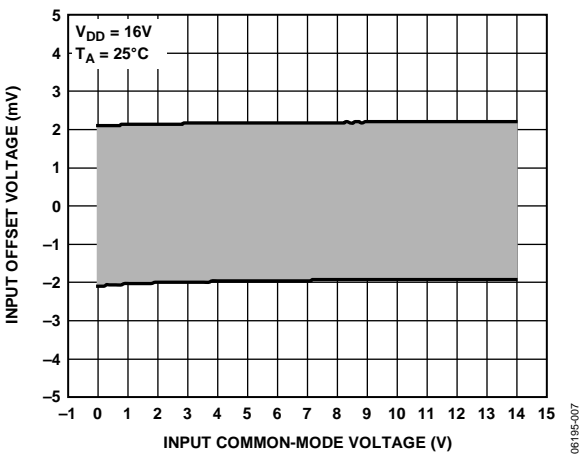
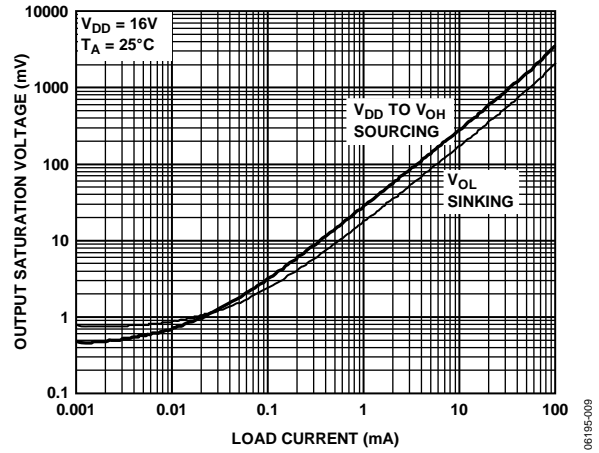
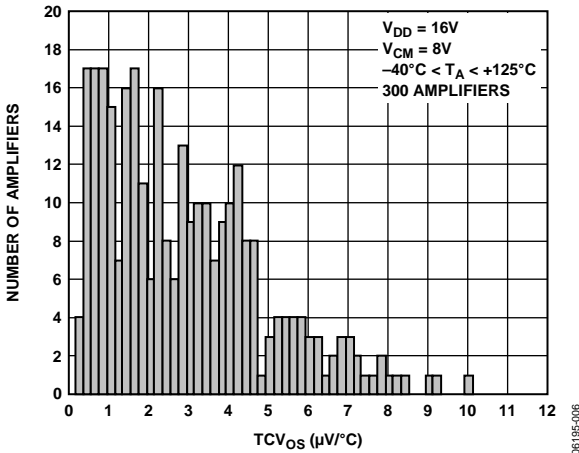
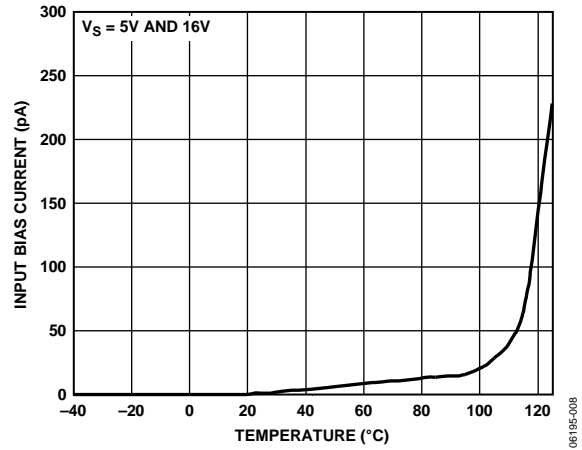
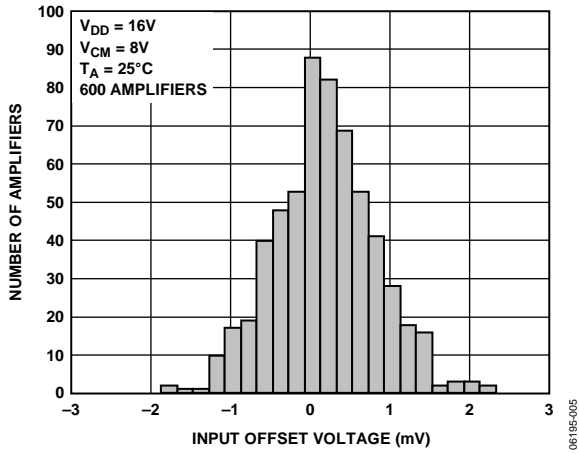

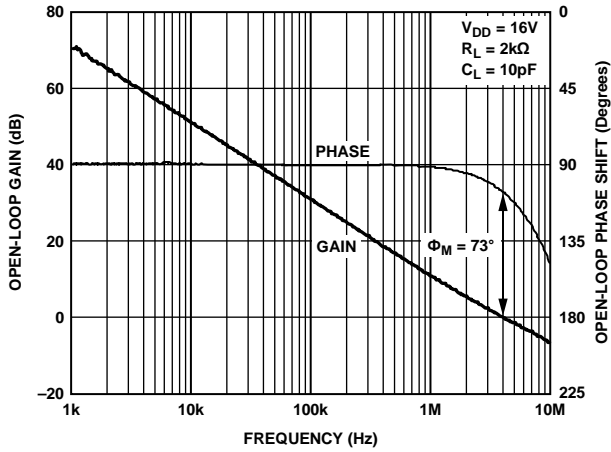

Figure 13. Open-Loop Gain and Phase vs. Frequency

06195-011

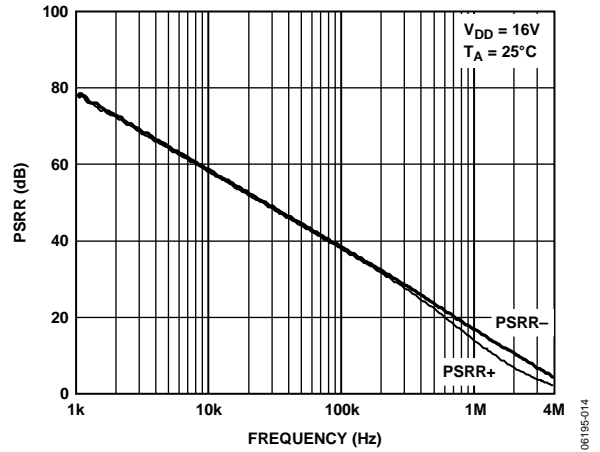

Figure 16. Power Supply Rejection Ratio vs. Frequency

06195-014

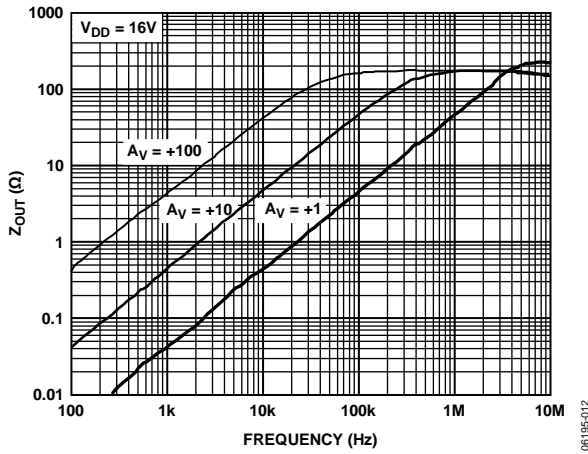

Figure 14. Closed-Loop Output Impedance vs. Frequency

06195-012

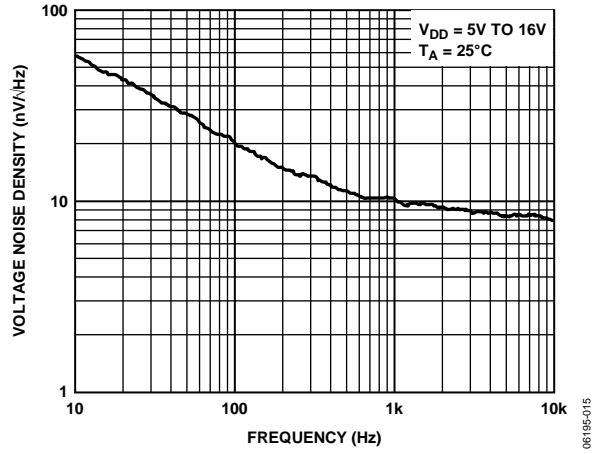

Figure 17. Voltage Noise Density vs. Frequency

06195-015

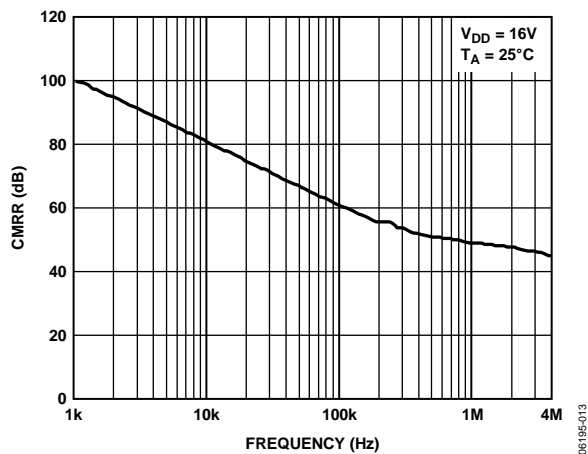

Figure 15. Common-Mode Rejection Ratio vs. Frequency

06195-013

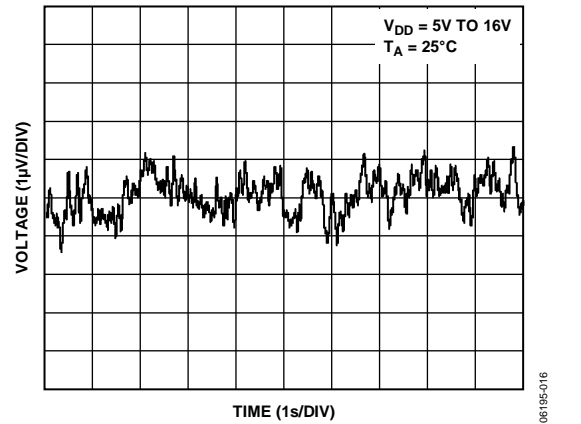

Figure 18. 0.1 Hz to 10 Hz Voltage Noise

06195-016

# AD8665/AD8666/AD8668

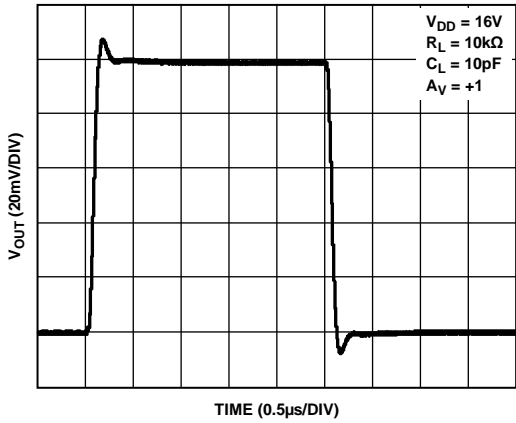

Figure 19. Small-Signal Transient Response

06195-017

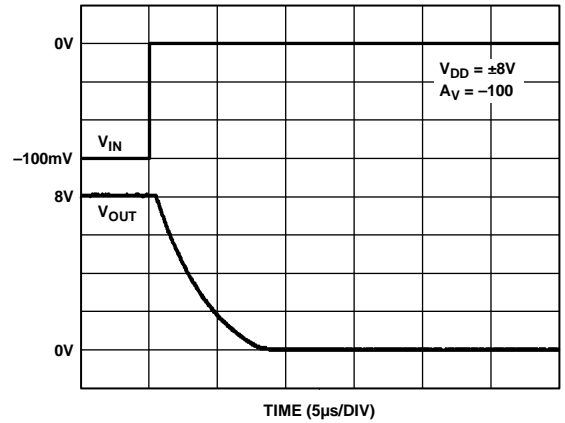

Figure 22. Positive Overload Recovery Time

06195-020

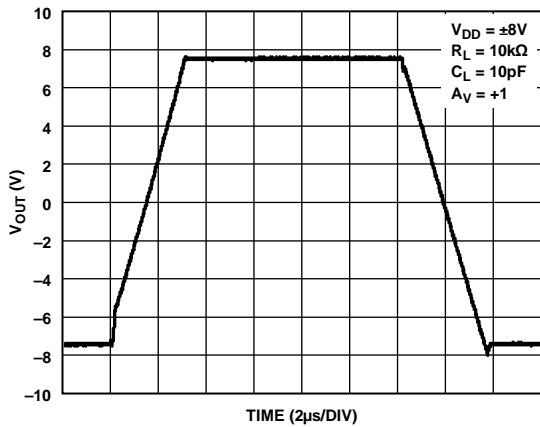

Figure 20. Large-Signal Transient Response

06195-018

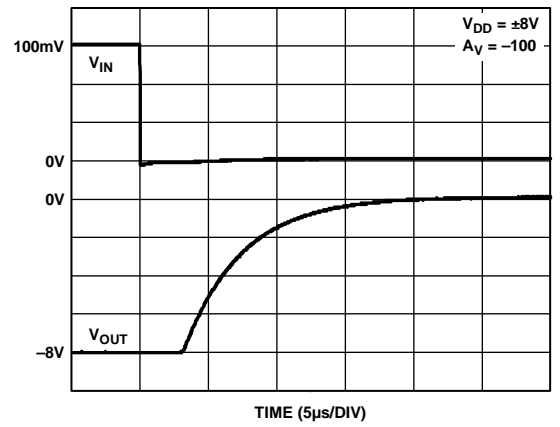

Figure 23. Negative Overload Recovery Time

06195-021

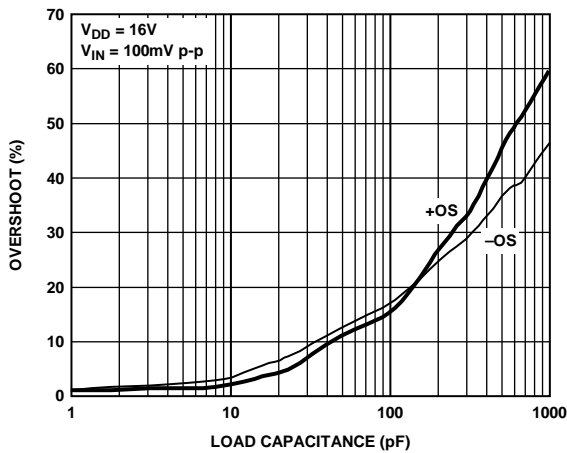

Figure 21. Small-Signal Overshoot vs. Load Capacitance

06195-019

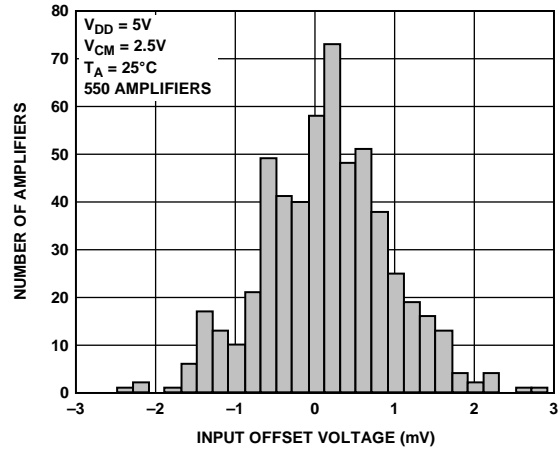

Figure 24. Input Offset Voltage Distribution

06195-022



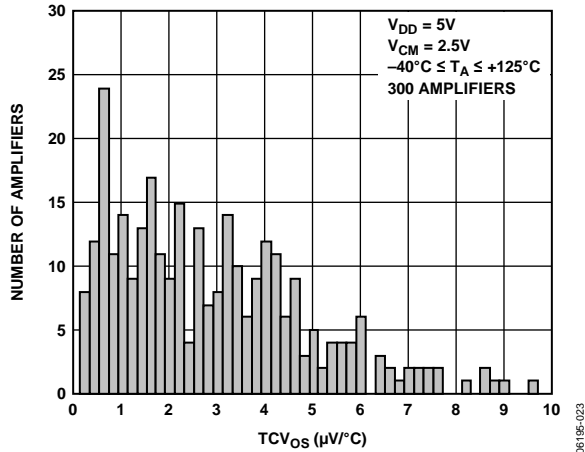

Figure 25.  $V_{OS}$  Drift ( $TCV_{OS}$ ) Distribution

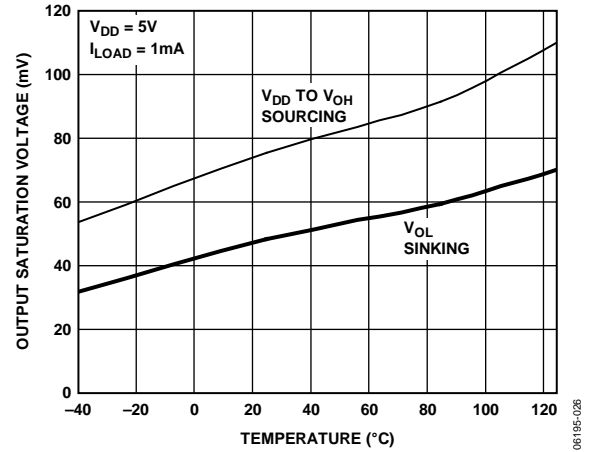

Figure 28. Output Saturation Voltage vs. Temperature

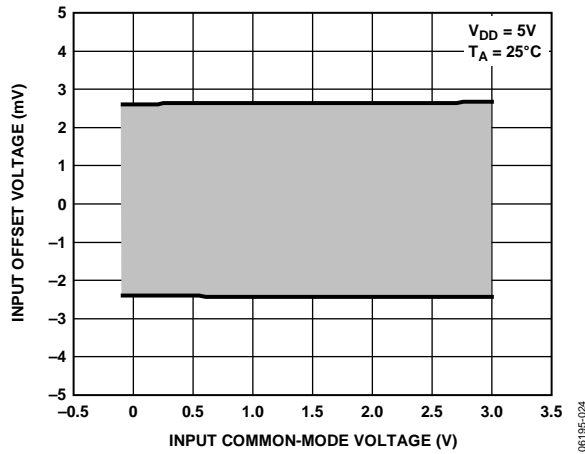

Figure 26. Offset Voltage vs. Common-Mode Voltage

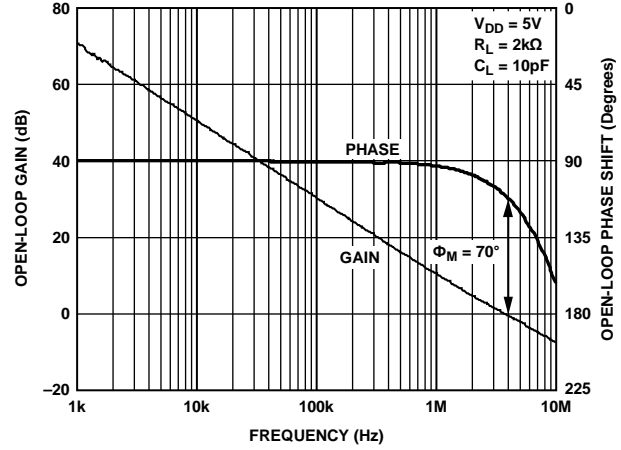

Figure 29. Open-Loop Gain and Phase vs. Frequency

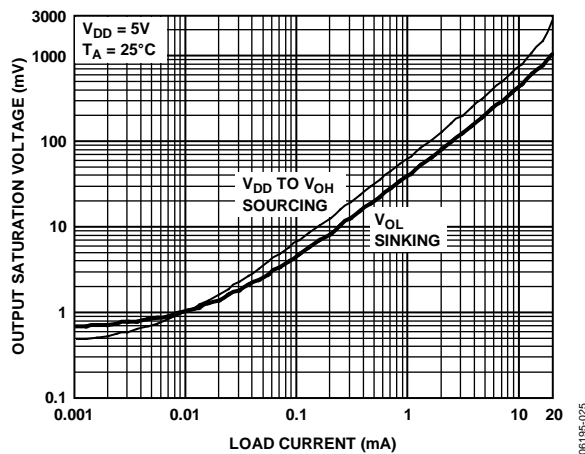

Figure 27. Output Saturation Voltage vs. Load Current

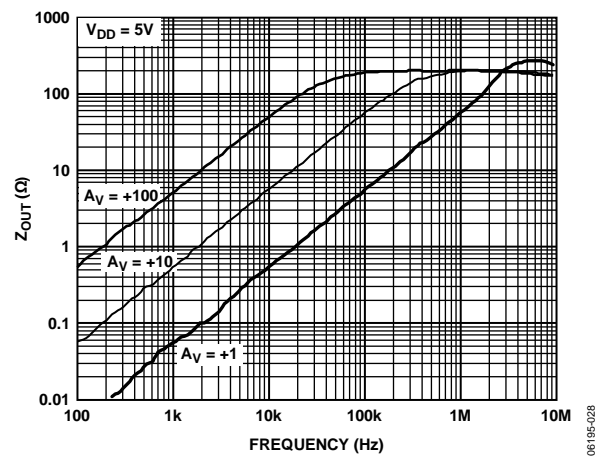

Figure 30. Closed-Loop Output Impedance vs. Frequency

# AD8665/AD8666/AD8668

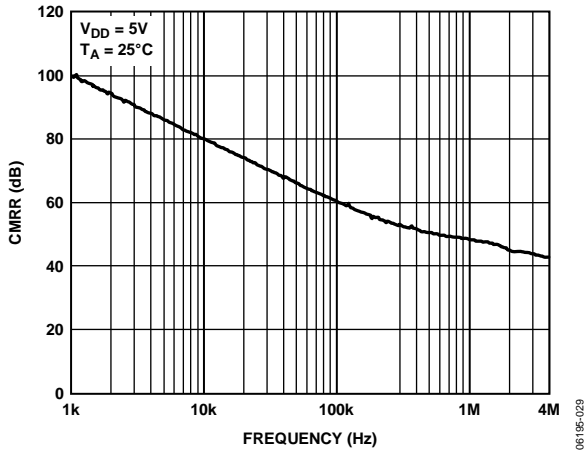

Figure 31. Common-Mode Rejection Ratio vs. Frequency

06195-029

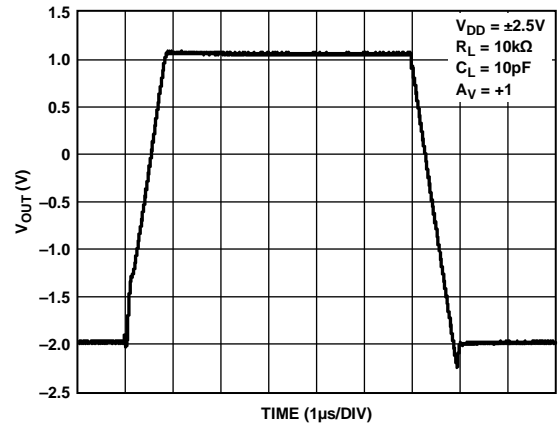

Figure 34. Large-Signal Transient Response

06195-032

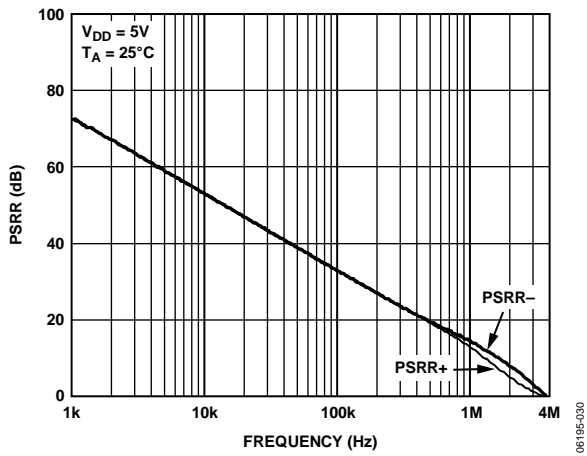

Figure 32. Power Supply Rejection Ratio vs. Frequency

06195-030

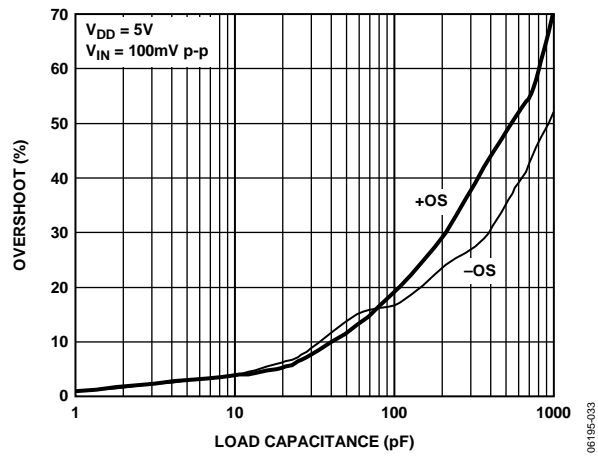

Figure 35. Small-Signal Overshoot vs. Load Capacitance

06195-033

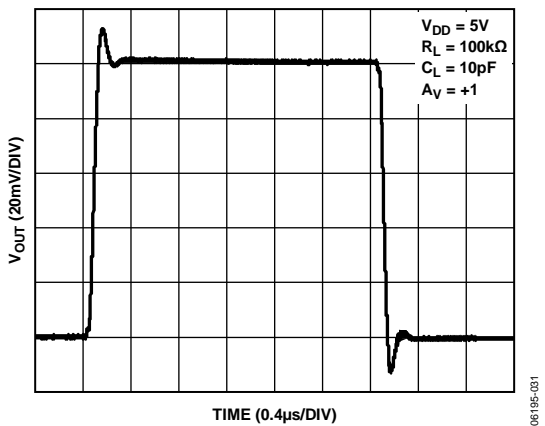

Figure 33. Small-Signal Transient Response

06195-031

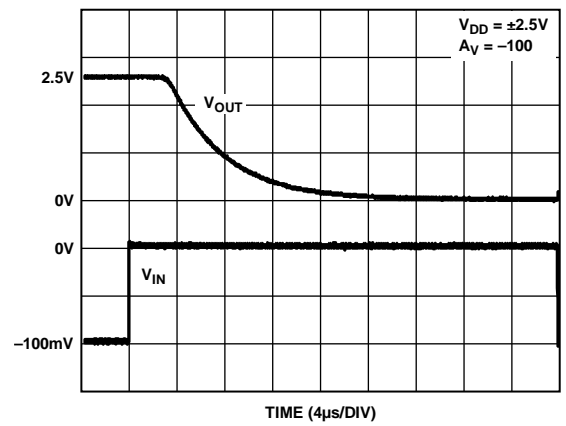

Figure 36. Positive Overload Recovery Time

06195-034

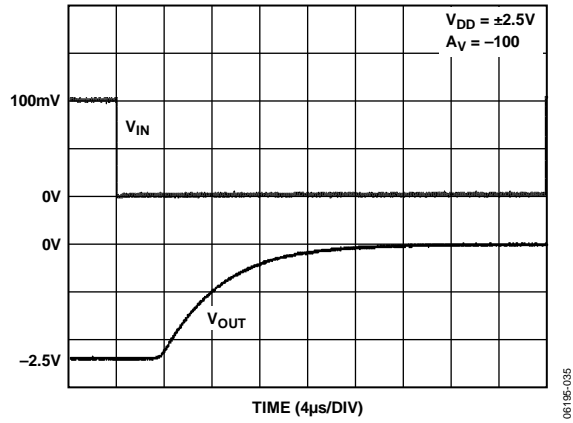

Figure 37. Negative Overload Recovery Time

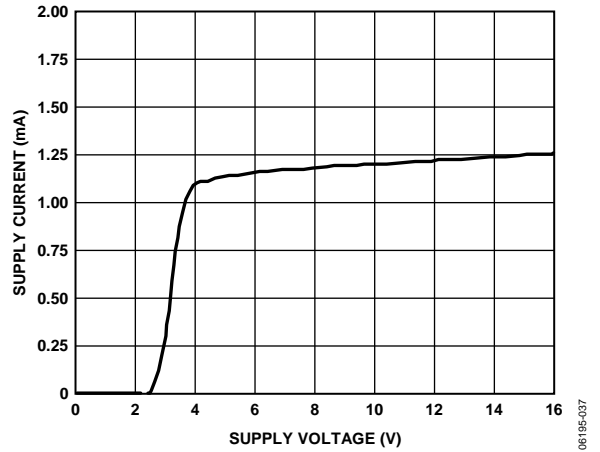

Figure 39. Supply Current vs. Supply Voltage

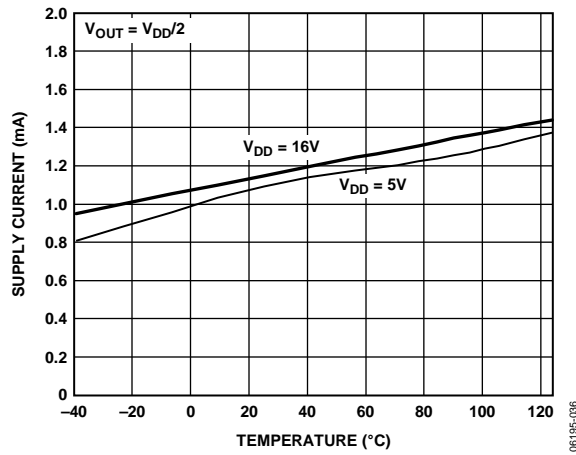

Figure 38. Supply Current vs. Temperature

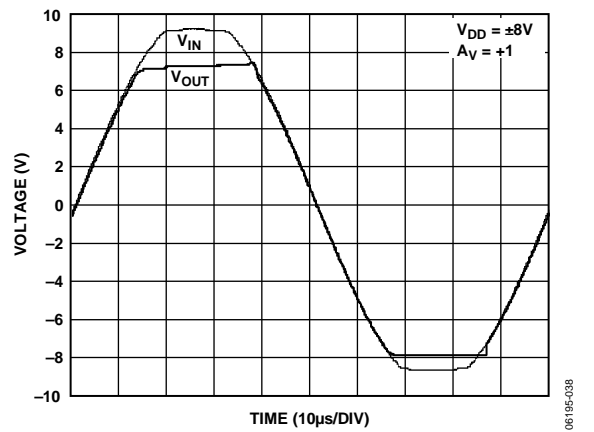
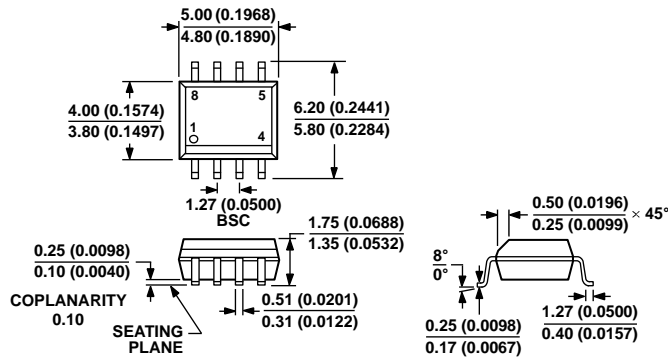

Figure 40. No Output Phase Reversal

OUTLINE DIMENSIONS



COMPLIANT TO JEDEC STANDARDS MS-012-AA  
 CONTROLLING DIMENSIONS ARE IN MILLIMETERS; INCH DIMENSIONS  
 (IN PARENTHESES) ARE ROUNDED-OFF MILLIMETER EQUIVALENTS FOR  
 REFERENCE ONLY AND ARE NOT APPROPRIATE FOR USE IN DESIGN.

Figure 41. 8-Lead Standard Small Outline Package [SOIC\_N]  
 Narrow Body  
 (R-8)

Dimensions shown in millimeters and (inches)

012407-A

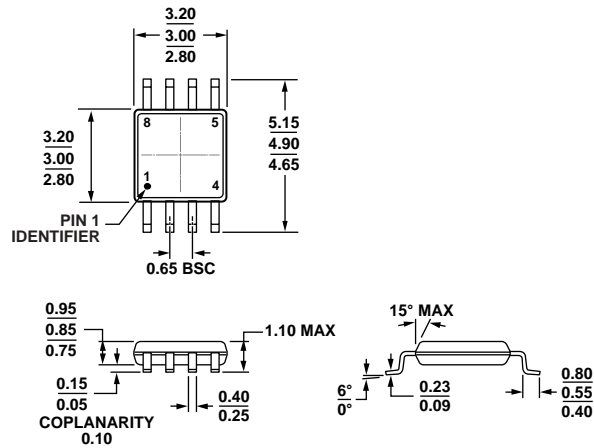

COMPLIANT TO JEDEC STANDARDS MO-187-AA  
 Figure 42. 8-Lead Mini Small Outline Package [MSOP]  
 (RM-8)

Dimensions shown in millimeters

10-072008-B

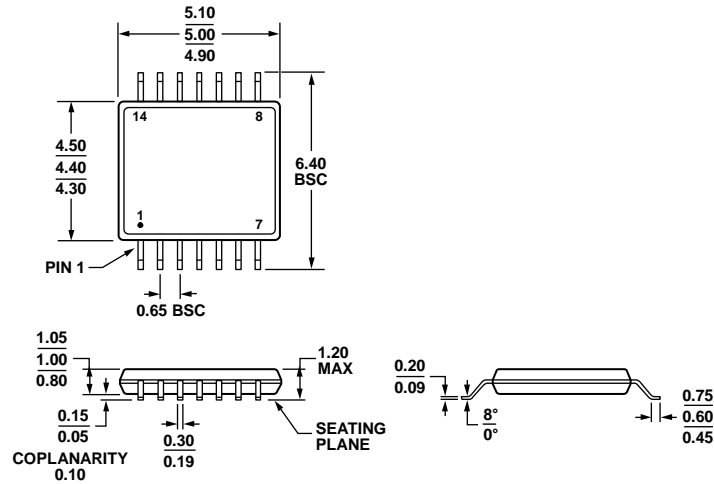

COMPLIANT TO JEDEC STANDARDS MO-153-AB-1

Figure 43. 14-Lead Thin Shrink Small Outline Package [TSSOP] (RU-14)

Dimensions shown in millimeters

061906-A

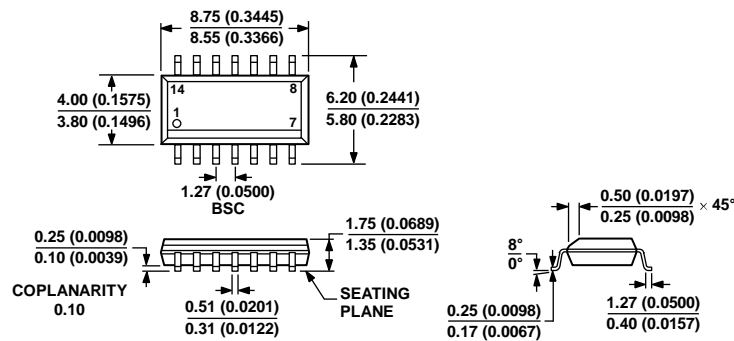

COMPLIANT TO JEDEC STANDARDS MS-012-AB  
CONTROLLING DIMENSIONS ARE IN MILLIMETERS; INCH DIMENSIONS  
(IN PARENTHESES) ARE ROUNDED-OFF MILLIMETER EQUIVALENTS FOR  
REFERENCE ONLY AND ARE NOT APPROPRIATE FOR USE IN DESIGN.

Figure 44. 14-Lead Standard Small Outline Package [SOIC\_N] Narrow Body (R-14)

Dimensions shown in millimeters and (inches)

060606-A

# AD8665/AD8666/AD8668

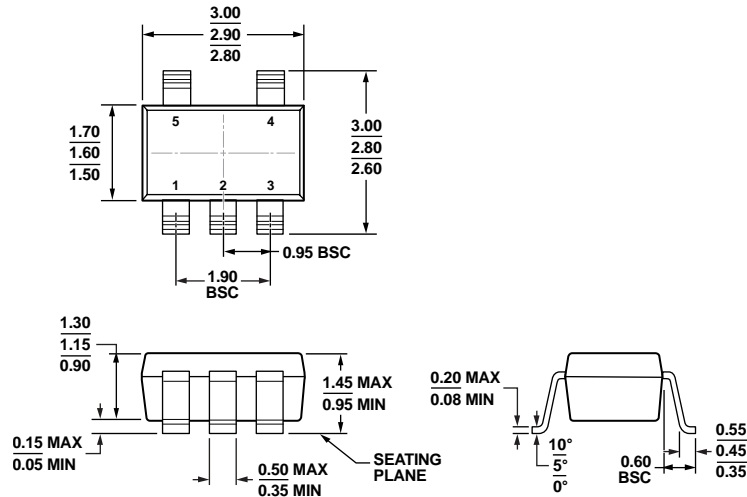

COMPLIANT TO JEDEC STANDARDS MO-178-AA

Figure 45. 5-Lead Small Outline Transistor Package [SOT-23] (RJ-5)

Dimensions shown in millimeters

11-01-2010-A

## ORDERING GUIDE

| Model <sup>1,2</sup> | Temperature Range | Package Description | Package Option | Branding |
|----------------------|-------------------|---------------------|----------------|----------|
| AD8665ARZ            | -40°C to +125°C   | 8-Lead SOIC_N       | R-8            |          |
| AD8665ARZ-REEL       | -40°C to +125°C   | 8-Lead SOIC_N       | R-8            |          |
| AD8665ARZ-REEL7      | -40°C to +125°C   | 8-Lead SOIC_N       | R-8            |          |
| AD8665ARJZ-R2        | -40°C to +125°C   | 5-Lead SOT-23       | RJ-5           | A1B      |
| AD8665ARJZ-REEL      | -40°C to +125°C   | 5-Lead SOT-23       | RJ-5           | A1B      |
| AD8665ARJZ-REEL7     | -40°C to +125°C   | 5-Lead SOT-23       | RJ-5           | A1B      |
| AD8666ARZ            | -40°C to +125°C   | 8-Lead SOIC_N       | R-8            |          |
| AD8666ARZ-REEL       | -40°C to +125°C   | 8-Lead SOIC_N       | R-8            |          |
| AD8666ARZ-REEL7      | -40°C to +125°C   | 8-Lead SOIC_N       | R-8            |          |
| AD8666ARMZ           | -40°C to +125°C   | 8-Lead MSOP         | RM-8           | A16      |
| AD8666ARMZ-REEL      | -40°C to +125°C   | 8-Lead MSOP         | RM-8           | A16      |
| AD8666WARZ-R7        | -40°C to +125°C   | 8-Lead SOIC_N       | R-8            |          |
| AD8666WARZ-RL        | -40°C to +125°C   | 8-Lead SOIC_N       | R-8            |          |
| AD8668ARZ            | -40°C to +125°C   | 14-Lead SOIC_N      | R-14           |          |
| AD8668ARZ-REEL       | -40°C to +125°C   | 14-Lead SOIC_N      | R-14           |          |
| AD8668ARZ-REEL7      | -40°C to +125°C   | 14-Lead SOIC_N      | R-14           |          |
| AD8668ARUZ           | -40°C to +125°C   | 14-Lead TSSOP       | RU-14          |          |
| AD8668ARUZ-REEL      | -40°C to +125°C   | 14-Lead TSSOP       | RU-14          |          |
| AD8668WARUZ-R7       | -40°C to +125°C   | 14-Lead TSSOP       | RU-14          |          |
| AD8668WARUZ-RL       | -40°C to +125°C   | 14-Lead TSSOP       | RU-14          |          |

<sup>1</sup> Z = RoHS Compliant Model

<sup>2</sup> W = Qualified for Automotive Applications.

## AUTOMOTIVE PRODUCTS

The AD8666W/AD8668W models are available with controlled manufacturing to support the quality and reliability requirements of automotive applications. Note that these automotive models may have specifications that differ from the commercial models; therefore, designers should review the Specifications section of this data sheet carefully. Only the automotive grade products shown are available for use in automotive applications. Contact your local Analog Devices account representative for specific product ordering information and to obtain the specific Automotive Reliability reports for these models.

**NOTES**

**AD8665/AD8666/AD8668**

## **NOTES**



Компания «Life Electronics» занимается поставками электронных компонентов импортного и отечественного производства от производителей и со складов крупных дистрибьюторов Европы, Америки и Азии.

С конца 2013 года компания активно расширяет линейку поставок компонентов по направлению коаксиальный кабель, кварцевые генераторы и конденсаторы (керамические, пленочные, электролитические), за счёт заключения дистрибьюторских договоров

Мы предлагаем:

- Конкуренспособные цены и скидки постоянным клиентам.
- Специальные условия для постоянных клиентов.
- Подбор аналогов.
- Поставку компонентов в любых объемах, удовлетворяющих вашим потребностям.
- Приемлемые сроки поставки, возможна ускоренная поставка.
- Доставку товара в любую точку России и стран СНГ.
- Комплексную поставку.
- Работу по проектам и поставку образцов.
- Формирование склада под заказчика.
- Сертификаты соответствия на поставляемую продукцию (по желанию клиента).
- Тестирование поставляемой продукции.
- Поставку компонентов, требующих военную и космическую приемку.
- Входной контроль качества.
- Наличие сертификата ISO.

В составе нашей компании организован Конструкторский отдел, призванный помогать разработчикам, и инженерам.

Конструкторский отдел помогает осуществить:

- Регистрацию проекта у производителя компонентов.
- Техническую поддержку проекта.
- Защиту от снятия компонента с производства.
- Оценку стоимости проекта по компонентам.
- Изготовление тестовой платы монтаж и пусконаладочные работы.



Тел: +7 (812) 336 43 04 (многоканальный)

Email: [org@lifeelectronics.ru](mailto:org@lifeelectronics.ru)