



BFU530W

NPN wideband silicon RF transistor

Rev. 1 — 13 January 2014

Product data sheet

1. Product profile

1.1 General description

NPN silicon RF transistor for high speed, low noise applications in a plastic, 3-pin SOT323 package.

The BFU530W is part of the BFU5 family of transistors, suitable for small signal to medium power applications up to 2 GHz.

1.2 Features and benefits

- Low noise, high breakdown RF transistor
- AEC-Q101 qualified
- Minimum noise figure (NF_{min}) = 0.6 dB at 900 MHz
- Maximum stable gain 18.5 dB at 900 MHz
- 11 GHz f_T silicon technology

1.3 Applications

- Applications requiring high supply voltages and high breakdown voltages
- Broadband amplifiers up to 2 GHz
- Low noise amplifiers for ISM applications
- ISM band oscillators

1.4 Quick reference data

Table 1. Quick reference data

$T_{amb} = 25\text{ °C}$ unless otherwise specified

Symbol	Parameter	Conditions	Min	Typ	Max	Unit
V_{CB}	collector-base voltage	open emitter	-	-	24	V
V_{CE}	collector-emitter voltage	open base	-	-	12	V
		shorted base	-	-	24	V
V_{EB}	emitter-base voltage	open collector	-	-	2	V
I_C	collector current		-	10	40	mA
P_{tot}	total power dissipation	$T_{sp} \leq 87\text{ °C}$	[1]	-	450	mW
h_{FE}	DC current gain	$I_C = 10\text{ mA}; V_{CE} = 8\text{ V}$	60	95	200	
C_c	collector capacitance	$V_{CB} = 8\text{ V}; f = 1\text{ MHz}$	-	0.68	-	pF
f_T	transition frequency	$I_C = 15\text{ mA}; V_{CE} = 8\text{ V}; f = 900\text{ MHz}$	-	11	-	GHz



Table 1. Quick reference data ...continued

$T_{amb} = 25\text{ }^{\circ}\text{C}$ unless otherwise specified

Symbol	Parameter	Conditions	Min	Typ	Max	Unit
$G_{p(max)}$	maximum power gain	$I_C = 10\text{ mA}; V_{CE} = 8\text{ V}; f = 900\text{ MHz}$	[2]	-	18.5	dB
NF_{min}	minimum noise figure	$I_C = 1\text{ mA}; V_{CE} = 8\text{ V}; f = 900\text{ MHz}; \Gamma_S = \Gamma_{opt}$	-	0.6	-	dB
$P_{L(1dB)}$	output power at 1 dB gain compression	$I_C = 15\text{ mA}; V_{CE} = 8\text{ V}; Z_S = Z_L = 50\text{ }\Omega; f = 900\text{ MHz}$	-	10	-	dBm

[1] T_{sp} is the temperature at the solder point of the collector lead.

[2] If $K > 1$ then $G_{p(max)}$ is the maximum power gain. If $K < 1$ then $G_{p(max)} = MSG$.

2. Pinning information

Table 2. Discrete pinning

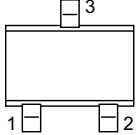
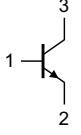
Pin	Description	Simplified outline	Graphic symbol
1	base		
2	emitter		
3	collector		

aaa-010458

3. Ordering information

Table 3. Ordering information

Type number	Package		
	Name	Description	Version
BFU530W	-	plastic surface-mounted package; 3 leads	SOT323
OM7960	-	Customer evaluation kit for BFU520W, BFU530W and BFU550W [1]	-

[1] The customer evaluation kit contains the following:

- a) Unpopulated RF amplifier Printed-Circuit Board (PCB)
- b) Unpopulated RF amplifier Printed-Circuit Board (PCB) with emitter degeneration
- c) Four SMA connectors for fitting unpopulated Printed-Circuit Board (PCB)
- d) BFU520W, BFU530W and BFU550W samples
- e) USB stick with data sheets, application notes, models, S-parameter and noise files

4. Marking

Table 4. Marking

Type number	Marking	Description
BFU530W	ZB*	* = t : made in Malaysia * = w : made in China

5. Design support

Table 5. Available design support

Download from the BFU530W product information page on <http://www.nxp.com>.

Support item	Available	Remarks
Device models for Agilent EEsof EDA ADS	yes	Based on Mextram device model.
SPICE model	yes	Based on Gummel-Poon device model.
S-parameters	yes	
Noise parameters	yes	
Customer evaluation kit	yes	See Section 3 and Section 10 .
Solder pattern	yes	
Application notes	yes	See Section 10.1 and Section 10.2 .

6. Limiting values

Table 6. Limiting values

In accordance with the Absolute Maximum Rating System (IEC 60134).

Symbol	Parameter	Conditions	Min	Max	Unit
V _{CB}	collector-base voltage	open emitter	-	30	V
V _{CE}	collector-emitter voltage	open base	-	16	V
		shorted base	-	30	V
V _{EB}	emitter-base voltage	open collector	-	3	V
I _C	collector current		-	65	mA
T _{stg}	storage temperature		-65	+150	°C
V _{ESD}	electrostatic discharge voltage	Human Body Model (HBM) According to JEDEC standard 22-A114E	-	±150	V
		Charged Device Model (CDM) According to JEDEC standard 22-C101B	-	±2	kV

7. Recommended operating conditions

Table 7. Characteristics

Symbol	Parameter	Conditions	Min	Typ	Max	Unit
V _{CB}	collector-base voltage	open emitter	-	-	24	V
V _{CE}	collector-emitter voltage	open base	-	-	12	V
		shorted base	-	-	24	V
V _{EB}	emitter-base voltage	open collector	-	-	2	V
I _C	collector current		-	-	40	mA
P _i	input power	Z _S = 50 Ω	-	-	10	dBm
T _j	junction temperature		-40	-	+150	°C
P _{tot}	total power dissipation	T _{sp} ≤ 87 °C	[1]	-	450	mW

[1] T_{sp} is the temperature at the solder point of the collector lead.

8. Thermal characteristics

Table 8. Thermal characteristics

Symbol	Parameter	Conditions	Typ	Unit
$R_{th(j-sp)}$	thermal resistance from junction to solder point		[1] 140	K/W

[1] T_{sp} is the temperature at the solder point of the collector lead.

T_{sp} has the following relation to the ambient temperature T_{amb} :

$$T_{sp} = T_{amb} + P \times R_{th(sp-a)}$$

With P being the power dissipation and $R_{th(sp-a)}$ being the thermal resistance between the solder point and ambient. $R_{th(sp-a)}$ is determined by the heat transfer properties in the application.

The heat transfer properties are set by the application board materials, the board layout and the environment e.g. housing.

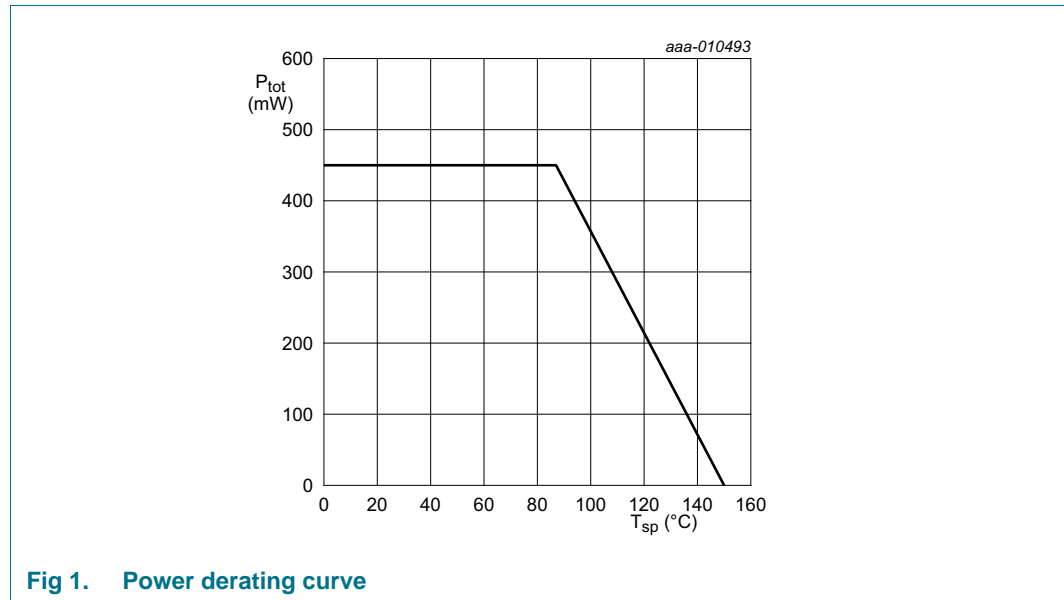

Fig 1. Power derating curve

9. Characteristics

Table 9. Characteristics

$T_{amb} = 25\text{ °C}$ unless otherwise specified

Symbol	Parameter	Conditions	Min	Typ	Max	Unit
$V_{(BR)CBO}$	collector-base breakdown voltage	$I_C = 100\text{ nA}; I_E = 0\text{ mA}$	24	-	-	V
$V_{(BR)CEO}$	collector-emitter breakdown voltage	$I_C = 150\text{ nA}; I_B = 0\text{ mA}$	12	-	-	V
I_C	collector current		-	10	40	mA
I_{CBO}	collector-base cut-off current	$I_E = 0\text{ mA}; V_{CB} = 8\text{ V}$	-	<1	-	nA
h_{FE}	DC current gain	$I_C = 10\text{ mA}; V_{CE} = 8\text{ V}$	60	95	200	
C_e	emitter capacitance	$V_{EB} = 0.5\text{ V}; f = 1\text{ MHz}$	-	0.84	-	pF
C_{re}	feedback capacitance	$V_{CE} = 8\text{ V}; f = 1\text{ MHz}$	-	0.43	-	pF
C_c	collector capacitance	$V_{CB} = 8\text{ V}; f = 1\text{ MHz}$	-	0.68	-	pF
f_T	transition frequency	$I_C = 15\text{ mA}; V_{CE} = 8\text{ V}; f = 900\text{ MHz}$	-	11	-	GHz

Table 9. Characteristics ...continued
 $T_{amb} = 25\text{ }^{\circ}\text{C}$ unless otherwise specified

Symbol	Parameter	Conditions	Min	Typ	Max	Unit		
$G_{p(max)}$	maximum power gain	$f = 433\text{ MHz}; V_{CE} = 8\text{ V}$	[1]					
		$I_C = 1\text{ mA}$	-	15.5	-	dB		
		$I_C = 10\text{ mA}$	-	23.5	-	dB		
		$I_C = 15\text{ mA}$	-	24	-	dB		
		$f = 900\text{ MHz}; V_{CE} = 8\text{ V}$	[1]					
		$I_C = 1\text{ mA}$	-	12.5	-	dB		
		$I_C = 10\text{ mA}$	-	18.5	-	dB		
		$I_C = 15\text{ mA}$	-	19	-	dB		
		$f = 1800\text{ MHz}; V_{CE} = 8\text{ V}$	[1]					
		$I_C = 1\text{ mA}$	-	10.5	-	dB		
		$I_C = 10\text{ mA}$	-	12.5	-	dB		
		$I_C = 15\text{ mA}$	-	12.5	-	dB		
		$ S_{21} ^2$	insertion power gain	$f = 433\text{ MHz}; V_{CE} = 8\text{ V}$				
				$I_C = 1\text{ mA}$	-	10	-	dB
				$I_C = 10\text{ mA}$	-	21.5	-	dB
$I_C = 15\text{ mA}$	-			22	-	dB		
$f = 900\text{ MHz}; V_{CE} = 8\text{ V}$								
$I_C = 1\text{ mA}$	-			8.5	-	dB		
$I_C = 10\text{ mA}$	-			16	-	dB		
$I_C = 15\text{ mA}$	-			16	-	dB		
$f = 1800\text{ MHz}; V_{CE} = 8\text{ V}$								
$I_C = 1\text{ mA}$	-			5	-	dB		
$I_C = 10\text{ mA}$	-			10.5	-	dB		
$I_C = 15\text{ mA}$	-			10.5	-	dB		
NF_{min}	minimum noise figure			$f = 433\text{ MHz}; V_{CE} = 8\text{ V}; \Gamma_S = \Gamma_{opt}$				
				$I_C = 1\text{ mA}$	-	0.5	-	dB
				$I_C = 10\text{ mA}$	-	0.8	-	dB
		$I_C = 15\text{ mA}$	-	0.9	-	dB		
		$f = 900\text{ MHz}; V_{CE} = 8\text{ V}; \Gamma_S = \Gamma_{opt}$						
		$I_C = 1\text{ mA}$	-	0.6	-	dB		
		$I_C = 10\text{ mA}$	-	0.9	-	dB		
		$I_C = 15\text{ mA}$	-	1.0	-	dB		
		$f = 1800\text{ MHz}; V_{CE} = 8\text{ V}; \Gamma_S = \Gamma_{opt}$						
		$I_C = 1\text{ mA}$	-	0.8	-	dB		
		$I_C = 10\text{ mA}$	-	1.0	-	dB		
		$I_C = 15\text{ mA}$	-	1.1	-	dB		

Table 9. Characteristics ...continued
 $T_{amb} = 25\text{ }^{\circ}\text{C}$ unless otherwise specified

Symbol	Parameter	Conditions	Min	Typ	Max	Unit		
G_{ass}	associated gain	$f = 433\text{ MHz}; V_{CE} = 8\text{ V}; \Gamma_S = \Gamma_{opt}$						
		$I_C = 1\text{ mA}$	-	22.5	-	dB		
		$I_C = 10\text{ mA}$	-	22.5	-	dB		
		$I_C = 15\text{ mA}$	-	23	-	dB		
		$f = 900\text{ MHz}; V_{CE} = 8\text{ V}; \Gamma_S = \Gamma_{opt}$						
		$I_C = 1\text{ mA}$	-	14.5	-	dB		
		$I_C = 10\text{ mA}$	-	16.5	-	dB		
		$I_C = 15\text{ mA}$	-	17	-	dB		
		$f = 1800\text{ MHz}; V_{CE} = 8\text{ V}; \Gamma_S = \Gamma_{opt}$						
		$I_C = 1\text{ mA}$	-	8.5	-	dB		
		$I_C = 10\text{ mA}$	-	11	-	dB		
		$I_C = 15\text{ mA}$	-	11	-	dB		
$P_{L(1dB)}$	output power at 1 dB gain compression	$f = 433\text{ MHz}; V_{CE} = 8\text{ V}; Z_S = Z_L = 50\text{ }\Omega$						
		$I_C = 10\text{ mA}$	-	6	-	dBm		
		$I_C = 15\text{ mA}$	-	9.5	-	dBm		
		$f = 900\text{ MHz}; V_{CE} = 8\text{ V}; Z_S = Z_L = 50\text{ }\Omega$						
		$I_C = 10\text{ mA}$	-	7	-	dBm		
		$I_C = 15\text{ mA}$	-	10	-	dBm		
		$f = 1800\text{ MHz}; V_{CE} = 8\text{ V}; Z_S = Z_L = 50\text{ }\Omega$						
		$I_C = 10\text{ mA}$	-	8	-	dBm		
		$I_C = 15\text{ mA}$	-	10.5	-	dBm		
		$IP3_o$	output third-order intercept point	$f_1 = 433\text{ MHz}; f_2 = 434\text{ MHz}; V_{CE} = 8\text{ V}; Z_S = Z_L = 50\text{ }\Omega$				
				$I_C = 10\text{ mA}$	-	16	-	dBm
				$I_C = 15\text{ mA}$	-	19	-	dBm
$f_1 = 900\text{ MHz}; f_2 = 901\text{ MHz}; V_{CE} = 8\text{ V}; Z_S = Z_L = 50\text{ }\Omega$								
$I_C = 10\text{ mA}$	-			17	-	dBm		
$I_C = 15\text{ mA}$	-			20	-	dBm		
$f_1 = 1800\text{ MHz}; f_2 = 1801\text{ MHz}; V_{CE} = 8\text{ V}; Z_S = Z_L = 50\text{ }\Omega$								
$I_C = 10\text{ mA}$	-			18	-	dBm		
$I_C = 15\text{ mA}$	-			20	-	dBm		

[1] If $K > 1$ then $G_{p(max)}$ is the maximum power gain. If $K < 1$ then $G_{p(max)} = MSG$.

9.1 Graphs

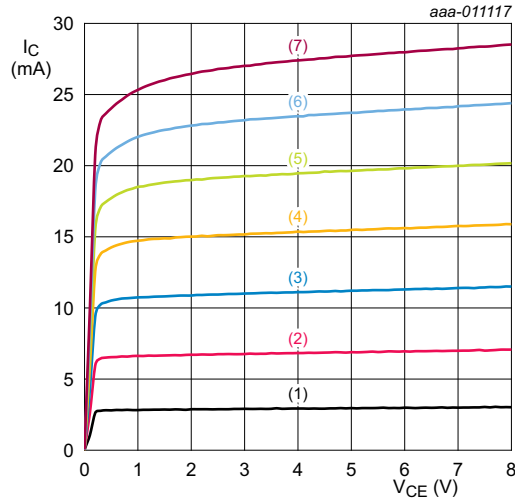

$T_{amb} = 25\text{ }^\circ\text{C}$.

- (1) $I_B = 25\text{ }\mu\text{A}$
- (2) $I_B = 75\text{ }\mu\text{A}$
- (3) $I_B = 125\text{ }\mu\text{A}$
- (4) $I_B = 175\text{ }\mu\text{A}$
- (5) $I_B = 225\text{ }\mu\text{A}$
- (6) $I_B = 275\text{ }\mu\text{A}$
- (7) $I_B = 325\text{ }\mu\text{A}$

Fig 2. Collector current as a function of collector-emitter voltage; typical values

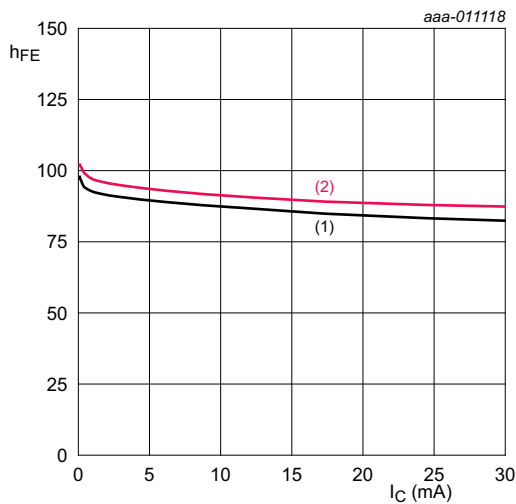

$T_{amb} = 25\text{ }^\circ\text{C}$.

- (1) $V_{CE} = 3.0\text{ V}$
- (2) $V_{CE} = 8.0\text{ V}$

Fig 3. DC current gain as function of collector current; typical values

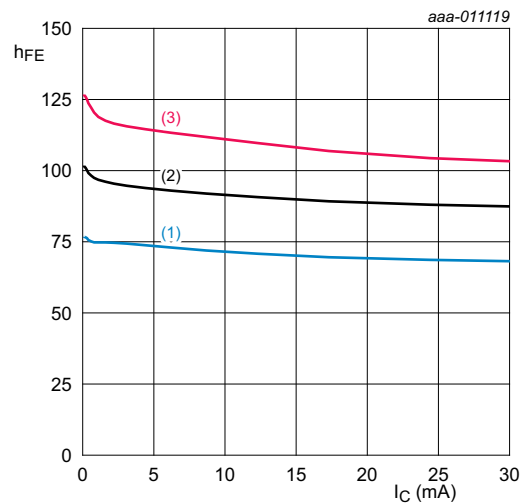

$V_{CE} = 8\text{ V}$.

- (1) $T_{amb} = -40\text{ }^\circ\text{C}$
- (2) $T_{amb} = +25\text{ }^\circ\text{C}$
- (3) $T_{amb} = +125\text{ }^\circ\text{C}$

Fig 4. DC current gain as function of collector current; typical values

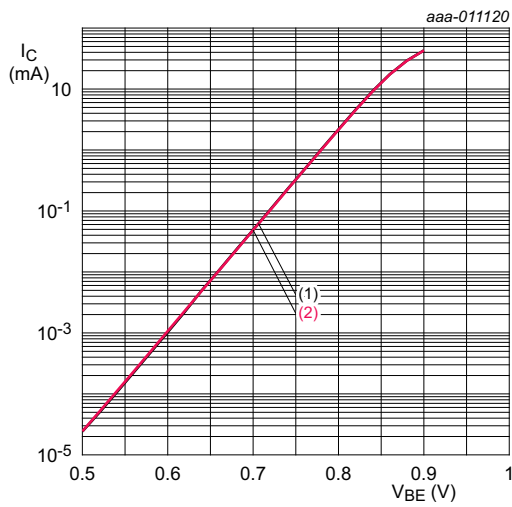

$T_{amb} = 25\text{ }^{\circ}\text{C}.$
 (1) $V_{CE} = 3.0\text{ V}$
 (2) $V_{CE} = 8.0\text{ V}$

Fig 5. Collector current as a function of base-emitter voltage; typical values

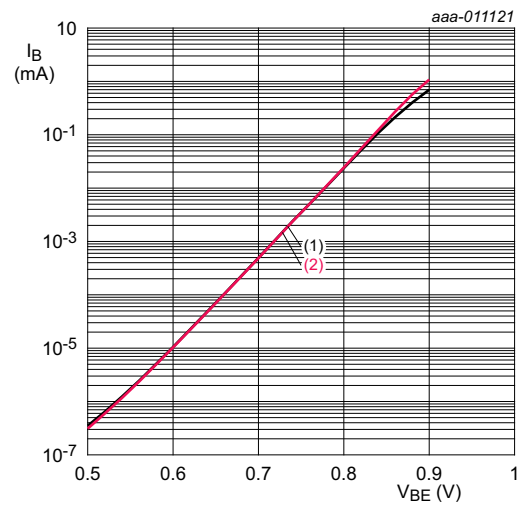

$T_{amb} = 25\text{ }^{\circ}\text{C}.$
 (1) $V_{CE} = 3.0\text{ V}$
 (2) $V_{CE} = 8.0\text{ V}$

Fig 6. Base current as a function of base-emitter voltage; typical values

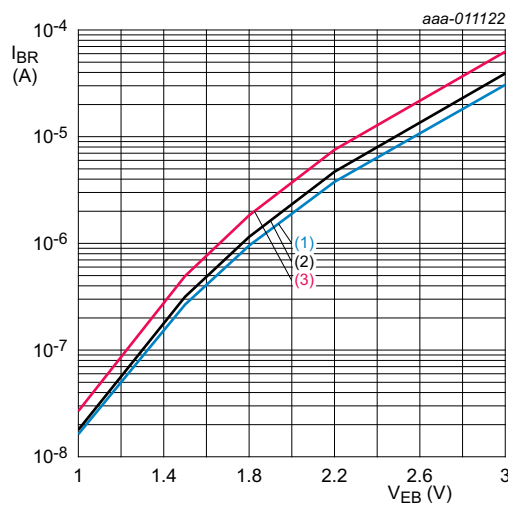

$V_{CE} = 3\text{ V}.$
 (1) $T_{amb} = -40\text{ }^{\circ}\text{C}$
 (2) $T_{amb} = +25\text{ }^{\circ}\text{C}$
 (3) $T_{amb} = +125\text{ }^{\circ}\text{C}$

Fig 7. Reverse base current as a function of emitter-base voltage; typical values

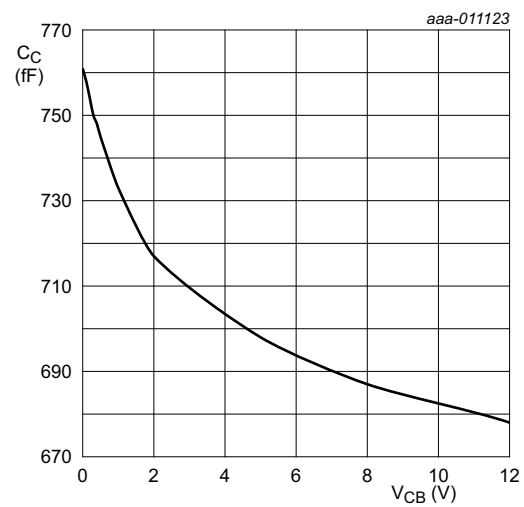

$I_C = 0\text{ mA}; f = 1\text{ MHz}; T_{amb} = 25\text{ }^{\circ}\text{C}.$

Fig 8. Collector capacitance as a function of collector-base voltage; typical values

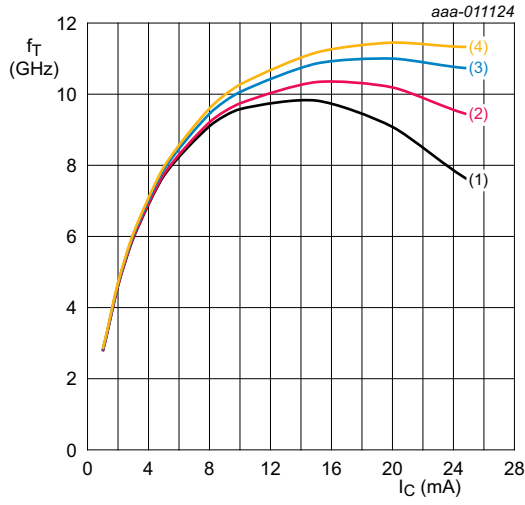

- $T_{amb} = 25\text{ }^{\circ}\text{C}.$
- (1) $V_{CE} = 3.3\text{ V}$
 - (2) $V_{CE} = 5.0\text{ V}$
 - (3) $V_{CE} = 8.0\text{ V}$
 - (4) $V_{CE} = 12.0\text{ V}$

Fig 9. Transition frequency as a function of collector current; typical values

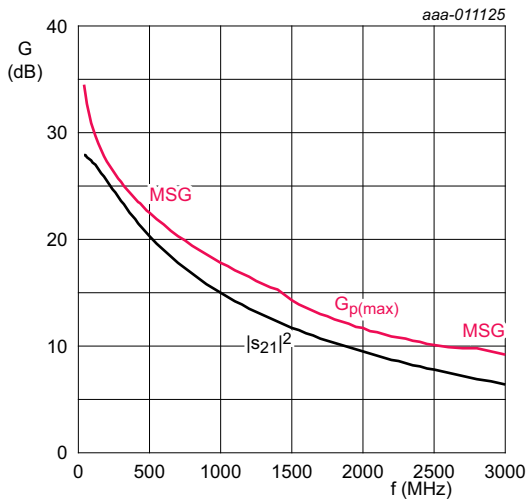

$I_C = 10\text{ mA}; V_{CE} = 8\text{ V}; T_{amb} = 25\text{ }^{\circ}\text{C}.$

Fig 10. Gain as a function of frequency; typical values

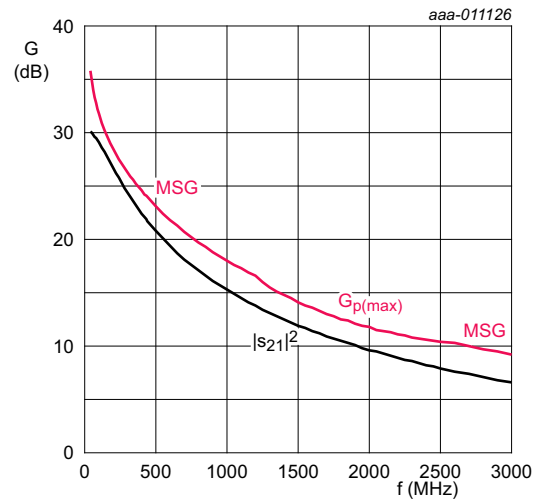

$I_C = 15\text{ mA}; V_{CE} = 8\text{ V}; T_{amb} = 25\text{ }^{\circ}\text{C}.$

Fig 11. Gain as a function of frequency; typical values

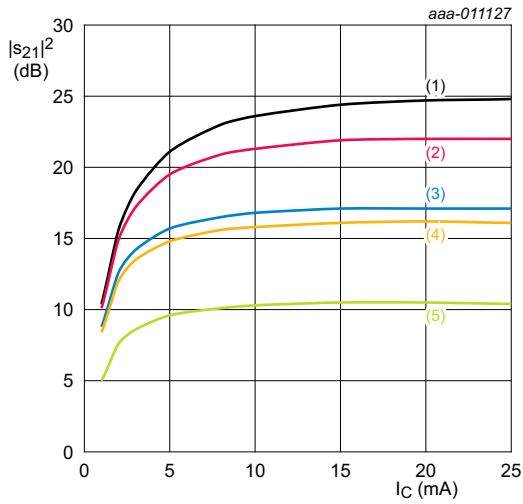

$V_{CE} = 8\text{ V}; T_{amb} = 25\text{ }^{\circ}\text{C}.$
 (1) $f = 300\text{ MHz}$
 (2) $f = 433\text{ MHz}$
 (3) $f = 800\text{ MHz}$
 (4) $f = 900\text{ MHz}$
 (5) $f = 1800\text{ MHz}$

Fig 12. Insertion power gain as a function of collector current; typical values

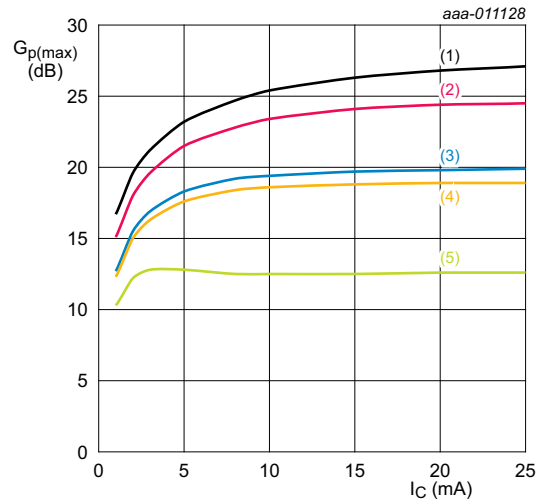

$V_{CE} = 8\text{ V}; T_{amb} = 25\text{ }^{\circ}\text{C}.$
 If $K > 1$ then $G_{p(max)}$ = maximum power gain. If $K < 1$ then $G_{p(max)}$ = MSG.
 (1) $f = 300\text{ MHz}$
 (2) $f = 433\text{ MHz}$
 (3) $f = 800\text{ MHz}$
 (4) $f = 900\text{ MHz}$
 (5) $f = 1800\text{ MHz}$

Fig 13. Maximum power gain as a function of collector current; typical values

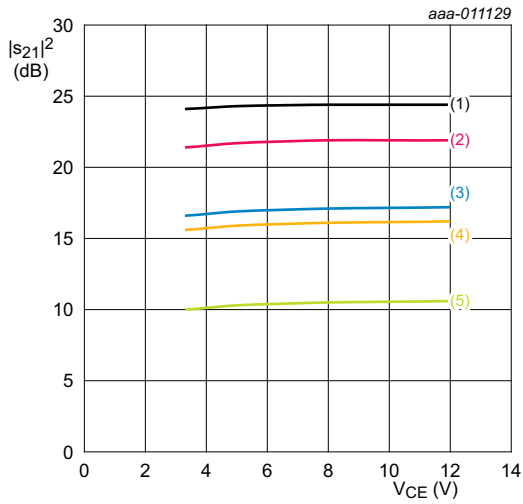

$I_C = 15 \text{ mA}; T_{\text{amb}} = 25 \text{ }^\circ\text{C}.$
 (1) $f = 300 \text{ MHz}$
 (2) $f = 433 \text{ MHz}$
 (3) $f = 800 \text{ MHz}$
 (4) $f = 900 \text{ MHz}$
 (5) $f = 1800 \text{ MHz}$

Fig 14. Insertion power gain as a function of collector-emitter voltage; typical values

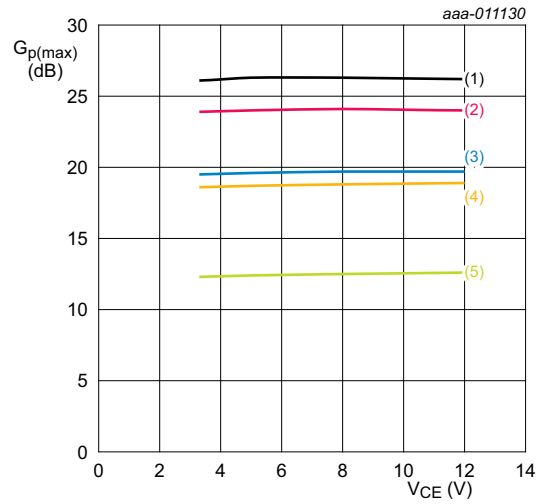

$I_C = 15 \text{ mA}; T_{\text{amb}} = 25 \text{ }^\circ\text{C}.$
 If $K > 1$ then $G_{p(\text{max})}$ = maximum power gain. If $K < 1$ then $G_{p(\text{max})}$ = MSG.
 (1) $f = 300 \text{ MHz}$
 (2) $f = 433 \text{ MHz}$
 (3) $f = 800 \text{ MHz}$
 (4) $f = 900 \text{ MHz}$
 (5) $f = 1800 \text{ MHz}$

Fig 15. Maximum power gain as a function of collector-emitter voltage; typical values

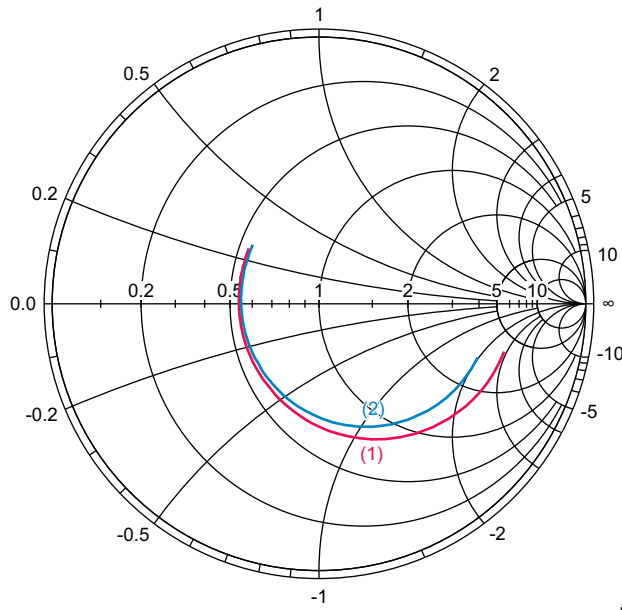

aaa-011131

$V_{CE} = 8\text{ V}; 40\text{ MHz} \leq f \leq 3\text{ GHz}.$

(1) $I_C = 10\text{ mA}$

(2) $I_C = 15\text{ mA}$

Fig 16. Input reflection coefficient (s_{11}); typical values

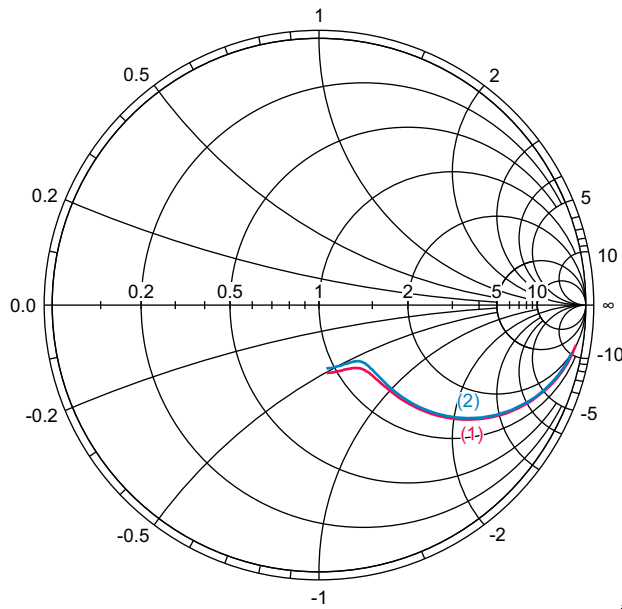

aaa-011132

$V_{CE} = 8\text{ V}; 40\text{ MHz} \leq f \leq 3\text{ GHz}.$

(1) $I_C = 10\text{ mA}$

(2) $I_C = 15\text{ mA}$

Fig 17. Output reflection coefficient (s_{22}); typical values

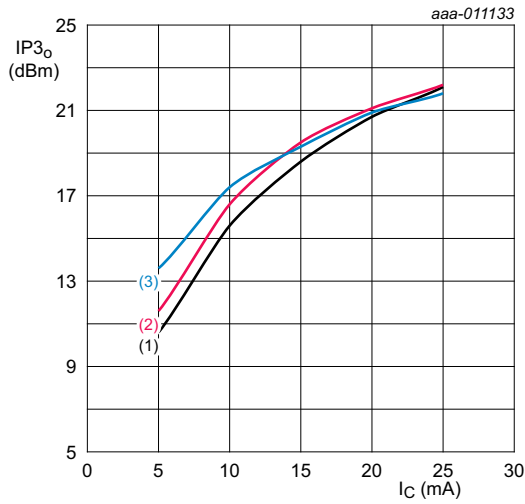

$V_{CE} = 8\text{ V}; T_{amb} = 25\text{ }^{\circ}\text{C}.$
 (1) $f_1 = 433\text{ MHz}; f_2 = 434\text{ MHz}$
 (2) $f_1 = 900\text{ MHz}; f_2 = 901\text{ MHz}$
 (3) $f_1 = 1800\text{ MHz}; f_2 = 1801\text{ MHz}$

Fig 18. Output third-order intercept point as a function of collector current; typical values

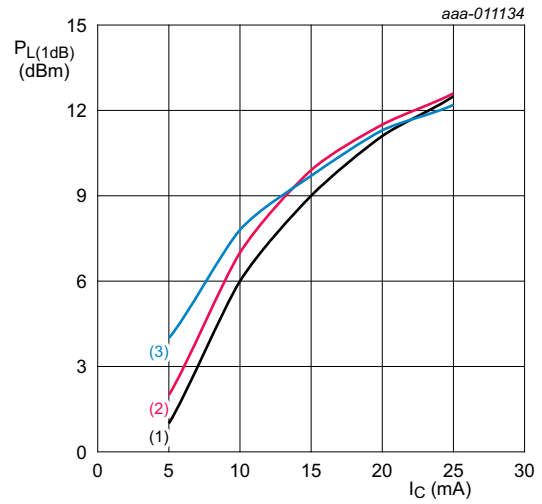

$V_{CE} = 8\text{ V}; T_{amb} = 25\text{ }^{\circ}\text{C}.$
 (1) $f = 433\text{ MHz}$
 (2) $f = 900\text{ MHz}$
 (3) $f = 1800\text{ MHz}$

Fig 19. Output power at 1 dB gain compression as a function of collector current; typical values

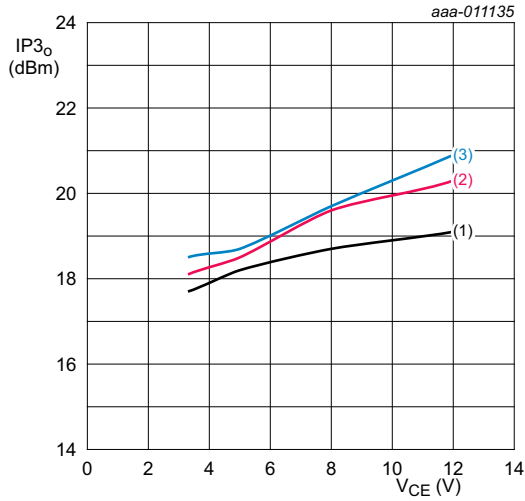

$I_C = 10\text{ mA}; T_{amb} = 25\text{ }^{\circ}\text{C}.$
 (1) $f_1 = 433\text{ MHz}; f_2 = 434\text{ MHz}$
 (2) $f_1 = 900\text{ MHz}; f_2 = 901\text{ MHz}$
 (3) $f_1 = 1800\text{ MHz}; f_2 = 1801\text{ MHz}$

Fig 20. Output third-order intercept point as a function of collector-emitter voltage; typical values

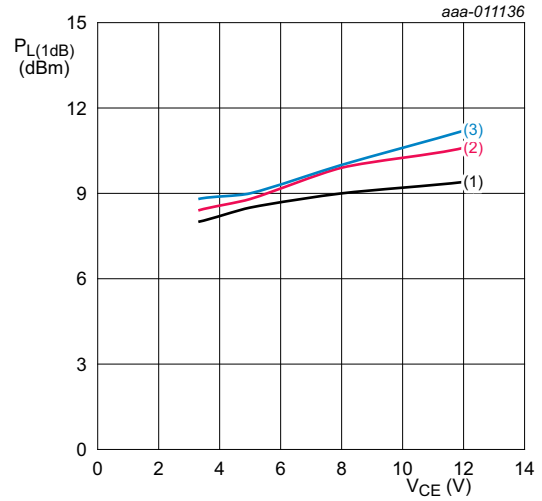

$I_C = 10\text{ mA}; T_{amb} = 25\text{ }^{\circ}\text{C}.$
 (1) $f = 433\text{ MHz}$
 (2) $f = 900\text{ MHz}$
 (3) $f = 1800\text{ MHz}$

Fig 21. Output power at 1 dB gain compression as a function of collector-emitter voltage; typical values

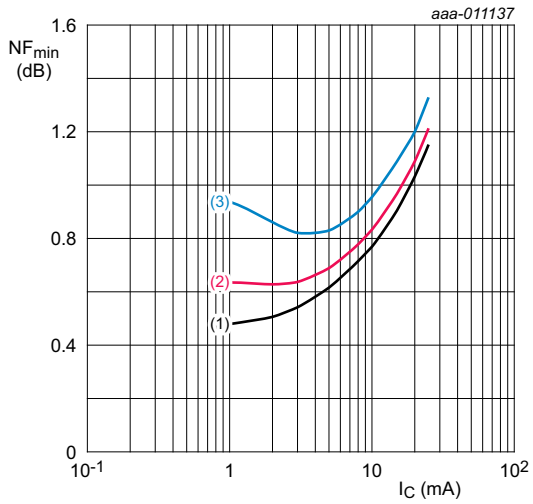

V_{CE} = 8 V; T_{amb} = 25 °C; Γ_S = Γ_{opt}.
 (1) f = 433 MHz
 (2) f = 900 MHz
 (3) f = 1800 MHz

Fig 22. Minimum noise figure as a function of collector current; typical values

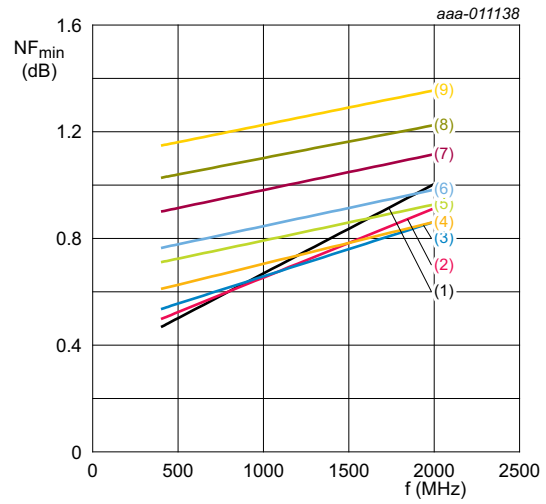

V_{CE} = 8 V; T_{amb} = 25 °C; Γ_S = Γ_{opt}.
 (1) I_C = 1 mA
 (2) I_C = 2 mA
 (3) I_C = 3 mA
 (4) I_C = 5 mA
 (5) I_C = 8 mA
 (6) I_C = 10 mA
 (7) I_C = 15 mA
 (8) I_C = 20 mA
 (9) I_C = 25 mA

Fig 23. Minimum noise figure as a function of frequency; typical values

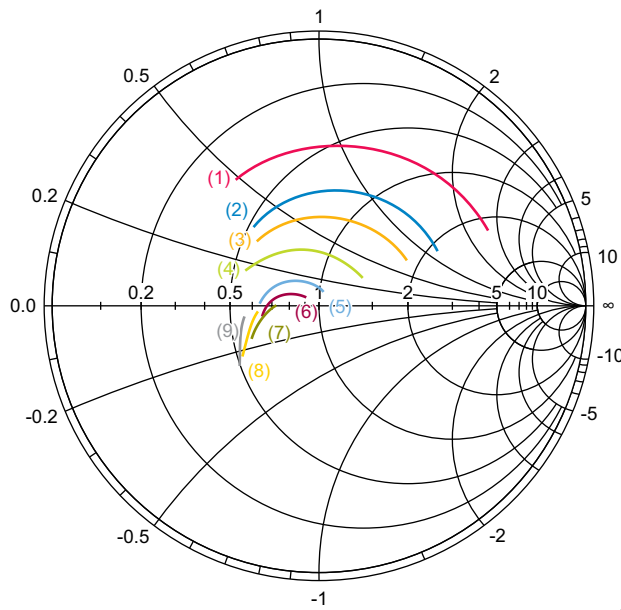

aaa-011139

$V_{CE} = 8 \text{ V}; 400 \text{ MHz} \leq f \leq 2 \text{ GHz}.$

- (1) $I_C = 1 \text{ mA}$
- (2) $I_C = 2 \text{ mA}$
- (3) $I_C = 3 \text{ mA}$
- (4) $I_C = 5 \text{ mA}$
- (5) $I_C = 8 \text{ mA}$
- (6) $I_C = 10 \text{ mA}$
- (7) $I_C = 15 \text{ mA}$
- (8) $I_C = 20 \text{ mA}$
- (9) $I_C = 25 \text{ mA}$

Fig 24. Optimum reflection coefficient (Γ_{opt}); typical values

10. Application information

More information about the following application example can be found in the application notes. See [Section 5 “Design support”](#).

The following application example can be implemented using the evaluation kit. See [Section 3 “Ordering information”](#) for the order type number.

The following application example can be simulated using the simulation package. See [Section 5 “Design support”](#).

10.1 Application example: 433 ISM band LNA

433 ISM band LNA, optimized for low noise.

More detailed information of the application example can be found in the application note: AN11423.

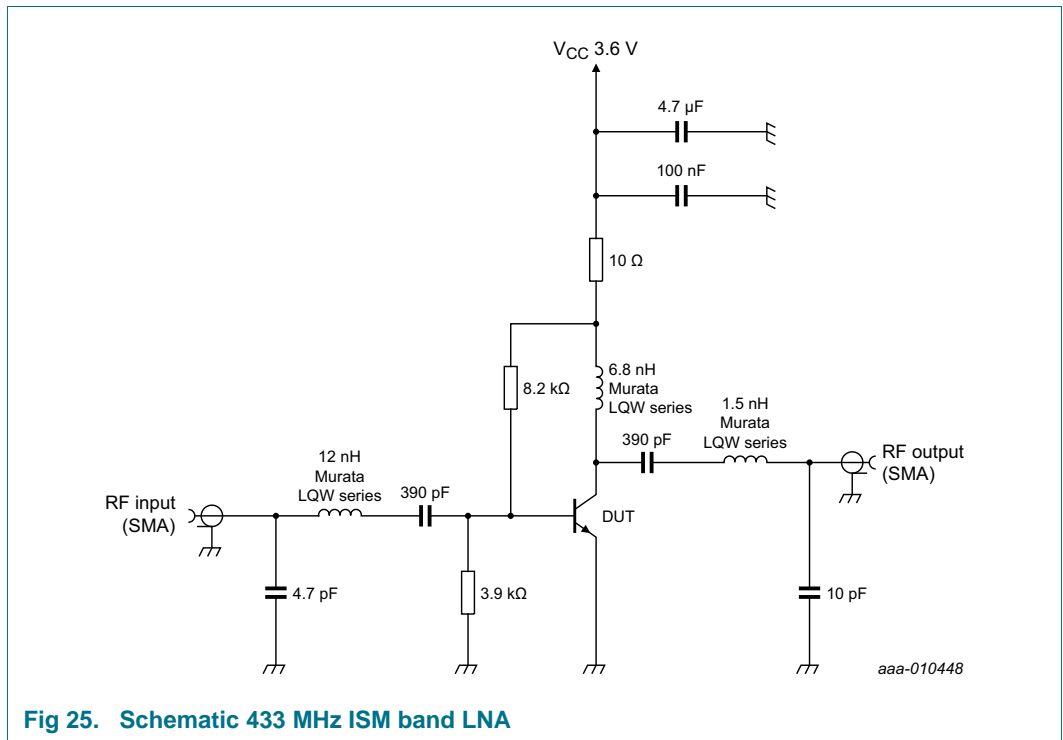

Fig 25. Schematic 433 MHz ISM band LNA

Table 10. Application performance data at 433 MHz

$I_{CC} = 10\text{ mA}$; $V_{CC} = 3.6\text{ V}$

Symbol	Parameter	Conditions	Min	Typ	Max	Unit
$ S_{21} ^2$	insertion power gain		-	17	-	dB
NF	noise figure		-	1.1	-	dB
IP3 _o	output third-order intercept point	$f_1 = 433.1\text{ MHz}$; $f_2 = 433.2\text{ MHz}$; $P_1 = -30\text{ dBm}$ per carrier	-	9	-	dBm

10.2 Application example: 866 ISM band LNA

866 ISM band LNA, optimized for low noise.

More detailed information of the application example can be found in the application note: AN11424.

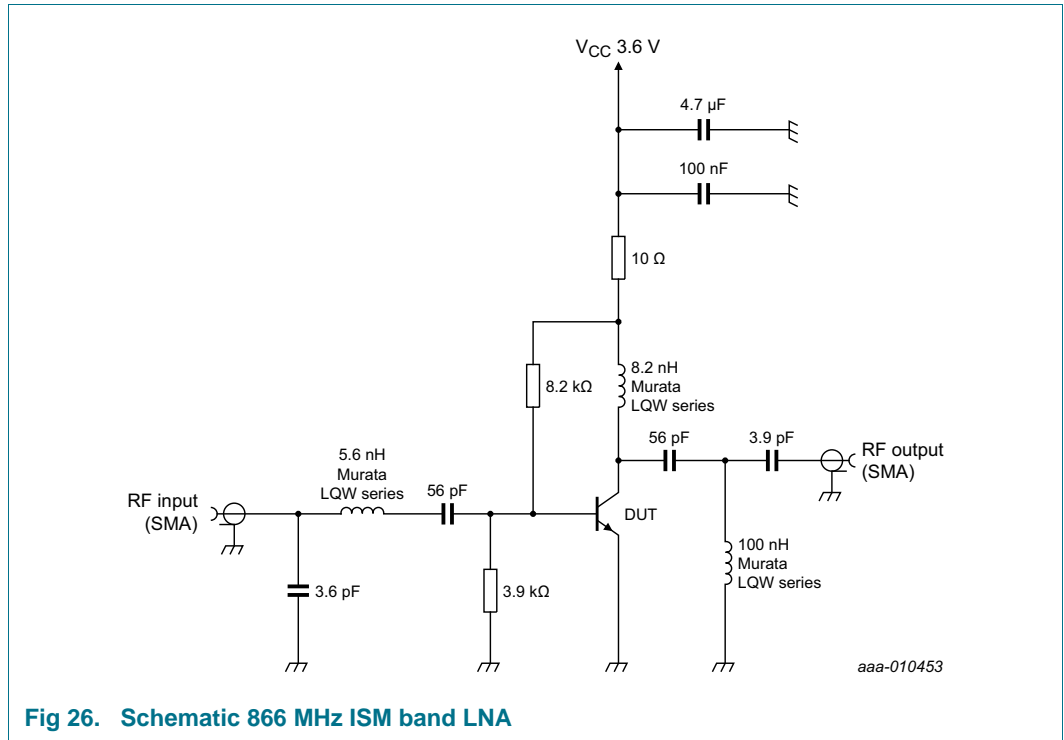

Fig 26. Schematic 866 MHz ISM band LNA

Table 11. Application performance data at 866 MHz

$I_{CC} = 10\text{ mA}$; $V_{CC} = 3.6\text{ V}$

Symbol	Parameter	Conditions	Min	Typ	Max	Unit
$ S_{21} ^2$	insertion power gain		-	15	-	dB
NF	noise figure		-	1.1	-	dB
IP3 _o	output third-order intercept point	$f_1 = 866.1\text{ MHz}$; $f_2 = 866.2\text{ MHz}$; $P_1 = -30\text{ dBm}$ per carrier	-	17	-	dBm

11. Package outline

Plastic surface-mounted package; 3 leads

SOT323

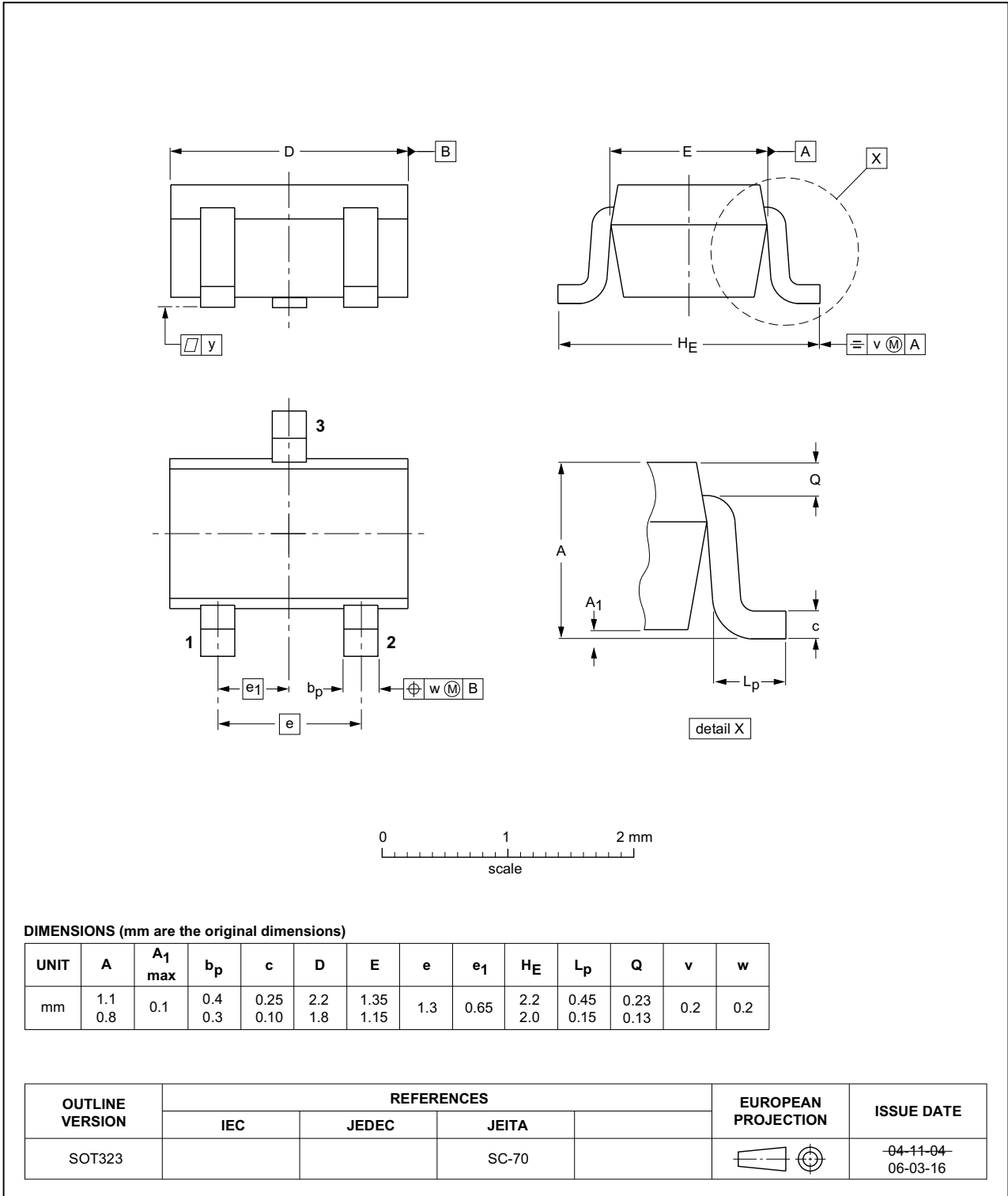

Fig 27. Package outline SOT323

12. Handling information

CAUTION



This device is sensitive to ElectroStatic Discharge (ESD). Observe precautions for handling electrostatic sensitive devices.

Such precautions are described in the *ANSI/ESD S20.20*, *IEC/ST 61340-5*, *JESD625-A* or equivalent standards.

13. Abbreviations

Table 12. Abbreviations

Acronym	Description
AEC	Automotive Electronics Council
ISM	Industrial, Scientific and Medical
LNA	Low-Noise Amplifier
MSG	Maximum Stable Gain
NPN	Negative-Positive-Negative
SMA	SubMiniature version A

14. Revision history

Table 13. Revision history

Document ID	Release date	Data sheet status	Change notice	Supersedes
BFU530W v.1	20140113	Product data sheet	-	-

15. Legal information

15.1 Data sheet status

Document status ^{[1][2]}	Product status ^[3]	Definition
Objective [short] data sheet	Development	This document contains data from the objective specification for product development.
Preliminary [short] data sheet	Qualification	This document contains data from the preliminary specification.
Product [short] data sheet	Production	This document contains the product specification.

[1] Please consult the most recently issued document before initiating or completing a design.

[2] The term 'short data sheet' is explained in section "Definitions".

[3] The product status of device(s) described in this document may have changed since this document was published and may differ in case of multiple devices. The latest product status information is available on the Internet at URL <http://www.nxp.com>.

15.2 Definitions

Draft — The document is a draft version only. The content is still under internal review and subject to formal approval, which may result in modifications or additions. NXP Semiconductors does not give any representations or warranties as to the accuracy or completeness of information included herein and shall have no liability for the consequences of use of such information.

Short data sheet — A short data sheet is an extract from a full data sheet with the same product type number(s) and title. A short data sheet is intended for quick reference only and should not be relied upon to contain detailed and full information. For detailed and full information see the relevant full data sheet, which is available on request via the local NXP Semiconductors sales office. In case of any inconsistency or conflict with the short data sheet, the full data sheet shall prevail.

Product specification — The information and data provided in a Product data sheet shall define the specification of the product as agreed between NXP Semiconductors and its customer, unless NXP Semiconductors and customer have explicitly agreed otherwise in writing. In no event however, shall an agreement be valid in which the NXP Semiconductors product is deemed to offer functions and qualities beyond those described in the Product data sheet.

15.3 Disclaimers

Limited warranty and liability — Information in this document is believed to be accurate and reliable. However, NXP Semiconductors does not give any representations or warranties, expressed or implied, as to the accuracy or completeness of such information and shall have no liability for the consequences of use of such information. NXP Semiconductors takes no responsibility for the content in this document if provided by an information source outside of NXP Semiconductors.

In no event shall NXP Semiconductors be liable for any indirect, incidental, punitive, special or consequential damages (including - without limitation - lost profits, lost savings, business interruption, costs related to the removal or replacement of any products or rework charges) whether or not such damages are based on tort (including negligence), warranty, breach of contract or any other legal theory.

Notwithstanding any damages that customer might incur for any reason whatsoever, NXP Semiconductors' aggregate and cumulative liability towards customer for the products described herein shall be limited in accordance with the *Terms and conditions of commercial sale* of NXP Semiconductors.

Right to make changes — NXP Semiconductors reserves the right to make changes to information published in this document, including without limitation specifications and product descriptions, at any time and without notice. This document supersedes and replaces all information supplied prior to the publication hereof.

Applications — Applications that are described herein for any of these products are for illustrative purposes only. NXP Semiconductors makes no representation or warranty that such applications will be suitable for the specified use without further testing or modification.

Customers are responsible for the design and operation of their applications and products using NXP Semiconductors products, and NXP Semiconductors accepts no liability for any assistance with applications or customer product design. It is customer's sole responsibility to determine whether the NXP Semiconductors product is suitable and fit for the customer's applications and products planned, as well as for the planned application and use of customer's third party customer(s). Customers should provide appropriate design and operating safeguards to minimize the risks associated with their applications and products.

NXP Semiconductors does not accept any liability related to any default, damage, costs or problem which is based on any weakness or default in the customer's applications or products, or the application or use by customer's third party customer(s). Customer is responsible for doing all necessary testing for the customer's applications and products using NXP Semiconductors products in order to avoid a default of the applications and the products or of the application or use by customer's third party customer(s). NXP does not accept any liability in this respect.

Limiting values — Stress above one or more limiting values (as defined in the Absolute Maximum Ratings System of IEC 60134) will cause permanent damage to the device. Limiting values are stress ratings only and (proper) operation of the device at these or any other conditions above those given in the Recommended operating conditions section (if present) or the Characteristics sections of this document is not warranted. Constant or repeated exposure to limiting values will permanently and irreversibly affect the quality and reliability of the device.

Terms and conditions of commercial sale — NXP Semiconductors products are sold subject to the general terms and conditions of commercial sale, as published at <http://www.nxp.com/profile/terms>, unless otherwise agreed in a valid written individual agreement. In case an individual agreement is concluded only the terms and conditions of the respective agreement shall apply. NXP Semiconductors hereby expressly objects to applying the customer's general terms and conditions with regard to the purchase of NXP Semiconductors products by customer.

No offer to sell or license — Nothing in this document may be interpreted or construed as an offer to sell products that is open for acceptance or the grant, conveyance or implication of any license under any copyrights, patents or other industrial or intellectual property rights.

Export control — This document as well as the item(s) described herein may be subject to export control regulations. Export might require a prior authorization from competent authorities.

Quick reference data — The Quick reference data is an extract of the product data given in the Limiting values and Characteristics sections of this document, and as such is not complete, exhaustive or legally binding.

Suitability for use in automotive applications — This NXP Semiconductors product has been qualified for use in automotive applications. Unless otherwise agreed in writing, the product is not designed, authorized or warranted to be suitable for use in life support, life-critical or safety-critical systems or equipment, nor in applications where failure or malfunction of an NXP Semiconductors product can reasonably be expected to result in personal injury, death or severe property or environmental damage. NXP Semiconductors and its suppliers accept no liability for inclusion and/or use of NXP Semiconductors products in such equipment or applications and therefore such inclusion and/or use is at the customer's own risk.

Translations — A non-English (translated) version of a document is for reference only. The English version shall prevail in case of any discrepancy between the translated and English versions.

15.4 Trademarks

Notice: All referenced brands, product names, service names and trademarks are the property of their respective owners.

16. Contact information

For more information, please visit: <http://www.nxp.com>

For sales office addresses, please send an email to: salesaddresses@nxp.com

17. Contents

1 Product profile 1

1.1 General description 1

1.2 Features and benefits 1

1.3 Applications 1

1.4 Quick reference data 1

2 Pinning information 2

3 Ordering information 2

4 Marking 2

5 Design support 3

6 Limiting values 3

7 Recommended operating conditions 3

8 Thermal characteristics 4

9 Characteristics 4

9.1 Graphs 7

10 Application information 15

10.1 Application example: 433 ISM band LNA 16

10.2 Application example: 866 ISM band LNA 17

11 Package outline 18

12 Handling information 19

13 Abbreviations 19

14 Revision history 19

15 Legal information 20

15.1 Data sheet status 20

15.2 Definitions 20

15.3 Disclaimers 20

15.4 Trademarks 21

16 Contact information 21

17 Contents 22

Please be aware that important notices concerning this document and the product(s) described herein, have been included in section 'Legal information'.

Компания «Life Electronics» занимается поставками электронных компонентов импортного и отечественного производства от производителей и со складов крупных дистрибьюторов Европы, Америки и Азии.

С конца 2013 года компания активно расширяет линейку поставок компонентов по направлению коаксиальный кабель, кварцевые генераторы и конденсаторы (керамические, пленочные, электролитические), за счёт заключения дистрибьюторских договоров

Мы предлагаем:

- Конкурентоспособные цены и скидки постоянным клиентам.
- Специальные условия для постоянных клиентов.
- Подбор аналогов.
- Поставку компонентов в любых объемах, удовлетворяющих вашим потребностям.
- Приемлемые сроки поставки, возможна ускоренная поставка.
- Доставку товара в любую точку России и стран СНГ.
- Комплексную поставку.
- Работу по проектам и поставку образцов.
- Формирование склада под заказчика.
- Сертификаты соответствия на поставляемую продукцию (по желанию клиента).
- Тестирование поставляемой продукции.
- Поставку компонентов, требующих военную и космическую приемку.
- Входной контроль качества.
- Наличие сертификата ISO.

В составе нашей компании организован Конструкторский отдел, призванный помогать разработчикам, и инженерам.

Конструкторский отдел помогает осуществить:

- Регистрацию проекта у производителя компонентов.
- Техническую поддержку проекта.
- Защиту от снятия компонента с производства.
- Оценку стоимости проекта по компонентам.
- Изготовление тестовой платы монтаж и пусконаладочные работы.



Тел: +7 (812) 336 43 04 (многоканальный)

Email: org@lifeelectronics.ru