

360 mW mono amplifier with standby mode

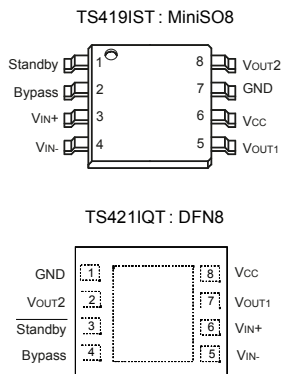

Features

- Operating from $V_{CC} = 2\text{ V}$ to 5.5 V
- Standby mode active high (TS419) or low (TS421)
- Output power into $16\ \Omega$: $367\text{ mW @ }5\text{ V}$ with 10% THD+N max or $295\text{ mW @ }5\text{ V}$ and $110\text{ mW @ }3.3\text{ V}$ with 1% THD+N max.
- Low current consumption: 2.5 mA max.
- High signal-to-noise ratio: 95 dB (A) at 5 V
- PSRR: 56 dB typ. at 1 kHz , 46 dB at 217 Hz
- Short-circuit limitation
- ON/OFF click reduction circuitry
- Available in MiniSO8 and DFN 3×3

Applications

- $16/32\ \Omega$ earpiece or receiver speaker driver
- Mobile and cordless phones (analog / digital)
- PDAs & computers
- Portable appliances

Description

The TS419/TS421 is a monaural audio power amplifier driving in BTL mode a 16 or $32\ \Omega$ earpiece or receiver speaker. The main advantage of this configuration is to get rid of bulky output capacitors.

Capable of descending to low voltages, it delivers up to 220 mW per channel (into $16\ \Omega$ loads) of continuous average power with 0.2% THD+N in the audio bandwidth from a 5 V power supply.

An externally controlled standby mode reduces the supply current to 10 nA (typ.). The TS419 / TS421 can be configured by external gain-setting resistors.

Maturity status link

[TS3431](#)

1 Maximum ratings

Table 1. Absolute maximum ratings

Symbol	Parameter	Value	Unit
V_{CC}	Supply voltage ⁽¹⁾	6	V
V_i	Input voltage	-0.3 V to $V_{CC} + 0.3$ V	V
T_{stg}	Storage temperature	-65 to +150	°C
T_j	Maximum junction temperature	150	°C
R_{thja}	Thermal resistance junction-to-ambient		
	MiniSO8	215	°C/W
DFN8	70		
P_d	Power dissipation ⁽²⁾		
	MiniSO8	0.58	W
DFN8	1.79		
ESD	Human body model (pin to pin): TS419 ⁽³⁾ , TS421	1.5	kV
ESD	Machine Model - 220 pF - 240 pF (pin to pin)	100	V
Latch-up	Latch-up Immunity (All pins)	200	mA
	Lead temperature (soldering, 10 s)	250	°C
	Output short-circuit to V_{CC} or GND	continuous ⁽⁴⁾	

1. All voltage values are measured with respect to the ground pin.
2. P_d has been calculated with $T_{amb} = 25$ °C, $T_j = 150$ °C.
3. TS419 stands 1.5 KV on all pins except standby pin which stands 1 KV
4. Attention must be paid to continuous power dissipation ($V_{DD} \times 300$ mA). Exposure of the IC to a short circuit for an extended time period is dramatically reducing product life expectancy.

Table 2. Operating conditions

Symbol	Parameter	Value	Unit
V_{CC}	Supply voltage	2 to 5.5	V
R_L	Load resistor	≥ 16	Ω
T_{oper}	Operating free air temperature range	-40 to +85	°C
C_L	Load capacitor		
	$R_L = 16$ to 100Ω	400	pF
$R_L > 100 \Omega$	100		
V_{ICM}	Common mode input voltage range	GND to $V_{CC} - 1$ V	V
V_{STB}	Standby voltage input	$1.5 \leq V_{STB} \leq V_{CC}$	V
	TS421 ACTIVE / TS419 in STANDBY TS421 in STANDBY / TS419 ACTIVE	GND $\leq V_{STB} \leq 0.4$ ⁽¹⁾	
R_{thja}	Thermal resistance junction-to-ambient		
	MiniSO8	190	°C/W
DFN8 ⁽²⁾	41		

Symbol	Parameter	Value	Unit
T_{WU}	Wake-up time from standby to active mode ($C_b = 1 \mu F$) ⁽³⁾	≥ 0.12	s

1. The minimum current consumption ($I_{STANDBY}$) is guaranteed at V_{CC} (TS419) or GND (TS421) for the whole temperature range.
2. When mounted on a 4-layer PCB.
3. For more details on T_{WU} , please refer to application note section on Wake-up time page 28.

2 Typical application schematics

Figure 1. Application schematics

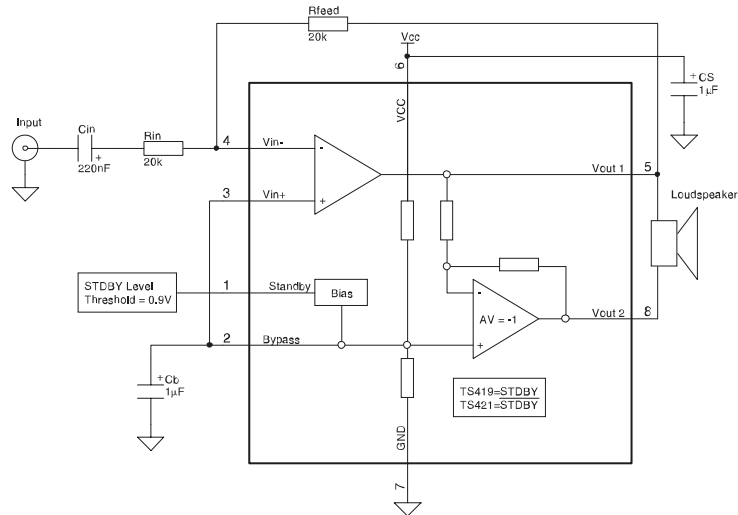

Table 3. Application components information

Components	Functional description
R_{IN}	Inverting input resistor which sets the closed loop gain in conjunction with R_{FEED} . This resistor also forms a high pass filter with C_{IN} ($f_{cl} = 1 / (2 \times P_i \times R_{IN} \times C_{IN})$).
C_{IN}	Input coupling capacitor which blocks the DC voltage at the amplifier's input terminal.
R_{FEED}	Feedback resistor which sets the closed loop gain in conjunction with R_{IN} . $A_V = \text{Closed Loop Gain} = 2 \times R_{FEED} / R_{IN}$.
C_S	Supply bypass capacitor which provides power supply filtering.
C_B	Bypass capacitor which provides half supply filtering.

3 Electrical characteristics

Table 4. Electrical characteristics $V_{CC} = +5\text{ V}$, $GND = 0\text{ V}$, $T_{amb} = 25\text{ °C}$ (unless otherwise specified)

Symbol	Parameter	Min.	Typ.	Max.	Unit
I_{CC}	Supply current No input signal, no load		6	8	mA
$I_{STANDBY}$	Standby current No input signal, $V_{STANDBY} = GND$ for TS421 No input signal, $V_{STANDBY} = V_{CC}$ for TS419		10	1000	nA
V_{OO}	Output offset voltage No input signal, $R_L = 16\ \Omega$ or $32\ \Omega$, $R_{feed} = 20\text{ k}\Omega$		5	25	mV
P_O	Output power THD+N = 0.1% Max, $F = 1\text{ kHz}$, $R_L = 32\ \Omega$		190		mW
	Output power THD+N = 1% Max, $F = 1\text{ kHz}$, $R_L = 32\ \Omega$	166	207		
	Output power THD+N = 10% Max, $F = 1\text{ kHz}$, $R_L = 32\ \Omega$		258		
	Output power THD+N = 0.1% Max, $F = 1\text{ kHz}$, $R_L = 16\ \Omega$		270		
	Output power THD+N = 1% Max, $F = 1\text{ kHz}$, $R_L = 16\ \Omega$	240	295		
	Output power THD+N = 10% Max, $F = 1\text{ kHz}$, $R_L = 16\ \Omega$		367		
THD + N	Total harmonic distortion + noise ($A_v = 2$) $R_L = 32\ \Omega$, $P_{out} = 150\text{ mW}$, $20\text{ Hz} \leq F \leq 20\text{ kHz}$ $R_L = 16\ \Omega$, $P_{out} = 220\text{ mW}$, $20\text{ Hz} \leq F \leq 20\text{ kHz}$		0.15 0.2		%
PSRR	Power supply rejection ratio ($A_v = 2$) $F = 1\text{ kHz}$, $V_{ripple} = 200\text{ mVpp}$, input grounded, $C_b = 1\ \mu\text{F}$	50	56		dB
SNR	Signal-to-Noise Ratio (Filter Type A, $A_v = 2$) ⁽¹⁾ ($R_L = 32\ \Omega$, THD + N < 0.5%, $20\text{ Hz} \leq F \leq 20\text{ kHz}$)	85	98		dB
ϕ_M	Phase margin at unity gain $R_L = 16\ \Omega$, $C_L = 400\text{ pF}$		58		Degrees
GM	Gain margin $R_L = 16\ \Omega$, $C_L = 400\text{ pF}$		18		dB
GBP	Gain bandwidth product $R_L = 16\ \Omega$		1.1		MHz
SR	Slew rate $R_L = 16\ \Omega$		0.4		V/ μS

1. Guaranteed by design and evaluation.

Table 5. Electrical characteristics $V_{CC} = +3.3\text{ V}$, $GND = 0\text{ V}$, $T_{amb} = 25\text{ °C}$ (unless otherwise specified)

Symbol	Parameter	Min.	Typ.	Max.	Unit
I_{CC}	Supply current No input signal, no load		1.8	2.5	mA
$I_{STANDBY}$	Standby current No input signal, $V_{STANDBY} = GND$ for TS421 No input signal, $V_{STANDBY} = V_{CC}$ for TS419		10	1000	nA
V_{OO}	Output offset voltage No input signal, $R_L = 16\ \Omega$ or $32\ \Omega$, $R_{feed} = 20\text{ k}\Omega$		5	25	mV
P_O	Output power THD+N = 0.1% Max, $F = 1\text{ kHz}$, $R_L = 32\ \Omega$		75		mW
	Output power THD+N = 1% Max, $F = 1\text{ kHz}$, $R_L = 32\ \Omega$	65	81		
	Output power THD+N = 10% Max, $F = 1\text{ kHz}$, $R_L = 32\ \Omega$		102		
	Output power THD+N = 0.1% Max, $F = 1\text{ kHz}$, $R_L = 16\ \Omega$		104		
	Output power THD+N = 1% Max, $F = 1\text{ kHz}$, $R_L = 16\ \Omega$	91	113		
	Output power THD+N = 10% Max, $F = 1\text{ kHz}$, $R_L = 16\ \Omega$		143		
THD + N	Total harmonic distortion + noise ($A_v = 2$) $R_L = 32\ \Omega$, $P_{out} = 150\text{ mW}$, $20\text{ Hz} \leq F \leq 20\text{ kHz}$ $R_L = 16\ \Omega$, $P_{out} = 220\text{ mW}$, $20\text{ Hz} \leq F \leq 20\text{ kHz}$		0.15 0.2		%
PSRR	Power supply rejection ratio ($A_v = 2$) $F = 1\text{ kHz}$, $V_{ripple} = 200\text{ mVpp}$, input grounded, $C_b = 1\ \mu\text{F}$	50	56		dB
SNR	Signal-to-Noise Ratio (Weighted A, $A_v = 2$) ($R_L = 32\ \Omega$, THD + N < 0.5%, $20\text{ Hz} \leq F \leq 20\text{ kHz}$)	82	94		dB
ϕ_M	Phase margin at unity gain $R_L = 16\ \Omega$, $C_L = 400\text{ pF}$		58		Degrees
GM	Gain margin $R_L = 16\ \Omega$, $C_L = 400\text{ pF}$		18		dB
GBP	Gain bandwidth product $R_L = 16\ \Omega$		1.1		MHz
SR	Slew rate $R_L = 16\ \Omega$		0.4		V/ μs

Note: All electrical values are guaranteed with correlation measurements at 2 V and 5 V.

Table 6. Electrical characteristics $V_{CC} = +2.5\text{ V}$, $GND = 0\text{ V}$, $T_{amb} = 25\text{ °C}$ (unless otherwise specified)

Symbol	Parameter	Min.	Typ.	Max.	Unit
I_{CC}	Supply current No input signal, no load		1.7	2.5	mA
$I_{STANDBY}$	Standby current No input signal, $V_{STANDBY} = GND$ for TS421 No input signal, $V_{STANDBY} = V_{CC}$ for TS419		10	1000	nA
V_{OO}	Output offset voltage No input signal, $R_L = 16\ \Omega$ or $32\ \Omega$, $R_{feed} = 20\text{ k}\Omega$		5	25	mV
P_O	Output power THD+N = 0.1% Max, $F = 1\text{ kHz}$, $R_L = 32\ \Omega$		37		mW
	Output power THD+N = 1% Max, $F = 1\text{ kHz}$, $R_L = 32\ \Omega$	32	41		
	Output power THD+N = 10% Max, $F = 1\text{ kHz}$, $R_L = 32\ \Omega$		52		
	Output power THD+N = 0.1% Max, $F = 1\text{ kHz}$, $R_L = 16\ \Omega$		50		
	Output power THD+N = 1% Max, $F = 1\text{ kHz}$, $R_L = 16\ \Omega$	44	55		
	Output power THD+N = 10% Max, $F = 1\text{ kHz}$, $R_L = 16\ \Omega$		70		
THD + N	Total harmonic distortion + noise ($A_v = 2$) $R_L = 32\ \Omega$, $P_{out} = 150\text{ mW}$, $20\text{ Hz} \leq F \leq 20\text{ kHz}$ $R_L = 16\ \Omega$, $P_{out} = 220\text{ mW}$, $20\text{ Hz} \leq F \leq 20\text{ kHz}$		0.15 0.2		%
PSRR	Power supply rejection ratio ($A_v = 2$) $F = 1\text{ kHz}$, $V_{ripple} = 200\text{ mVpp}$, input grounded, $C_b = 1\ \mu\text{F}$	50	56		dB
SNR	Signal-to-Noise Ratio (Weighted A, $A_v = 2$) ($R_L = 32\ \Omega$, THD + N < 0.5%, $20\text{ Hz} \leq F \leq 20\text{ kHz}$)	80	91		dB
ϕ_M	Phase margin at unity gain $R_L = 16\ \Omega$, $C_L = 400\text{ pF}$		58		Degrees
GM	Gain margin $R_L = 16\ \Omega$, $C_L = 400\text{ pF}$		18		dB
GBP	Gain bandwidth product $R_L = 16\ \Omega$		1.1		MHz
SR	Slew rate $R_L = 16\ \Omega$		0.4		V/ μS

Note: All electrical values are guaranteed with correlation measurements at 2 V and 5 V.

Table 7. Electrical characteristics $V_{CC} = +2\text{ V}$, $GND = 0\text{ V}$, $T_{amb} = 25\text{ °C}$ (unless otherwise specified)

Symbol	Parameter	Min.	Typ.	Max.	Unit
I_{CC}	Supply current No input signal, no load		1.7	2.5	mA
$I_{STANDBY}$	Standby current No input signal, $V_{STANDBY} = GND$ for TS421 No input signal, $V_{STANDBY} = V_{CC}$ for TS419		10	1000	nA
V_{OO}	Output offset voltage No input signal, $R_L = 16\ \Omega$ or $32\ \Omega$, $R_{feed} = 20\text{ k}\Omega$		5	25	mV
P_O	Output power THD+N = 0.1% Max, $F = 1\text{ kHz}$, $R_L = 32\ \Omega$		20		mW
	Output power THD+N = 1% Max, $F = 1\text{ kHz}$, $R_L = 32\ \Omega$	19	23		
	Output power THD+N = 10% Max, $F = 1\text{ kHz}$, $R_L = 32\ \Omega$		30		
	Output power THD+N = 0.1% Max, $F = 1\text{ kHz}$, $R_L = 16\ \Omega$		26		
	Output power THD+N = 1% Max, $F = 1\text{ kHz}$, $R_L = 16\ \Omega$	24	30		
	Output power THD+N = 10% Max, $F = 1\text{ kHz}$, $R_L = 16\ \Omega$		40		
THD + N	Total harmonic distortion + noise ($A_v = 2$) $R_L = 32\ \Omega$, $P_{out} = 150\text{ mW}$, $20\text{ Hz} \leq F \leq 20\text{ kHz}$ $R_L = 16\ \Omega$, $P_{out} = 220\text{ mW}$, $20\text{ Hz} \leq F \leq 20\text{ kHz}$		0.1 0.15		%
PSRR	Power supply rejection ratio ($A_v = 2$) ⁽¹⁾ $F = 1\text{ kHz}$, $V_{ripple} = 200\text{ mVpp}$, input grounded, $C_b = 1\ \mu\text{F}$	49	54		dB
SNR	Signal-to-Noise Ratio (Weighted A, $A_v = 2$) ⁽¹⁾ ($R_L = 32\ \Omega$, THD + N < 0.5%, $20\text{ Hz} \leq F \leq 20\text{ kHz}$)	80	89		dB
ϕ_M	Phase margin at unity gain $R_L = 16\ \Omega$, $C_L = 400\text{ pF}$		58		Degrees
GM	Gain margin $R_L = 16\ \Omega$, $C_L = 400\text{ pF}$		20		dB
GBP	Gain bandwidth product $R_L = 16\ \Omega$		1.1		MHz
SR	Slew rate $R_L = 16\ \Omega$		0.4		V/ μS

1. Guaranteed by design and evaluation.

4 Electrical characteristics curves

Figure 2. Open loop gain and phase vs. frequency

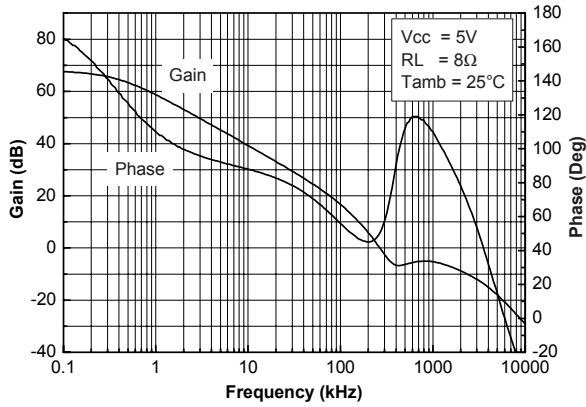

Figure 3. Open loop gain and phase vs. frequency
 $V_{CC} = 2V$

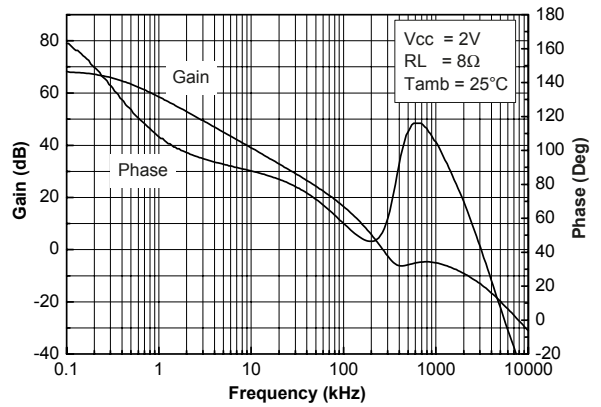

Figure 4. Open loop gain and phase vs. frequency
 $V_{CC} = 5V$

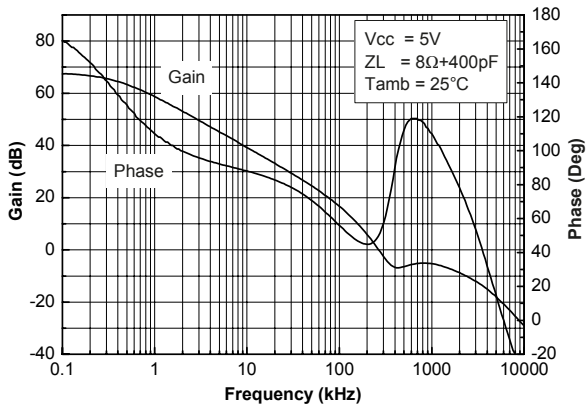

Figure 5. Open loop gain and phase vs. frequency
 $Z_L = 8\Omega$

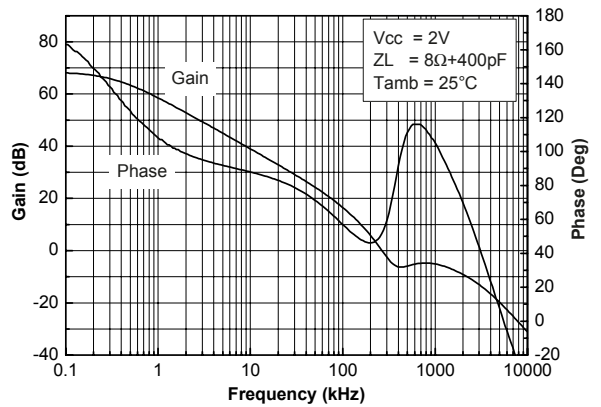

Figure 6. Open loop gain and phase vs. frequency
RL = 16 Ω

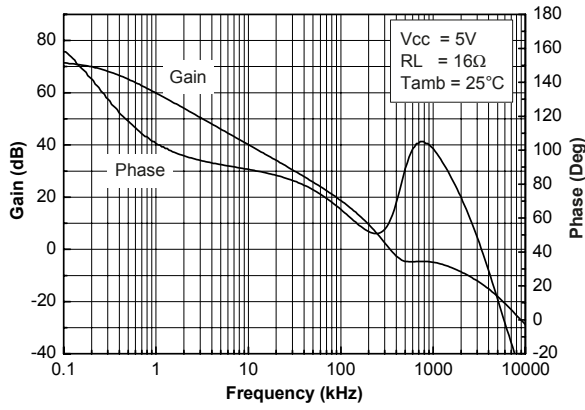

Figure 7. Open loop gain and phase vs. frequency
RL = 16 Ω, Vcc = 2 V

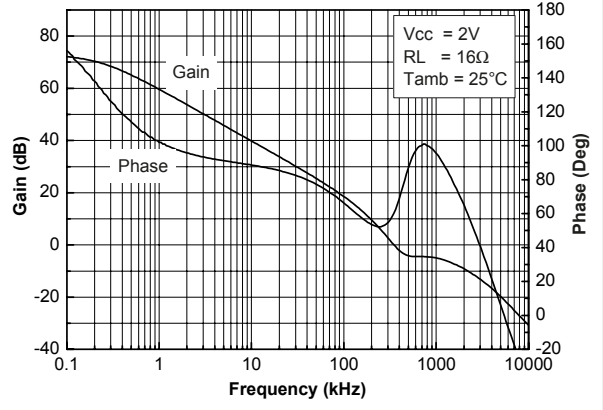

Figure 8. Open loop gain and phase vs. frequency
ZL = 16 Ω, Vcc = 5 V

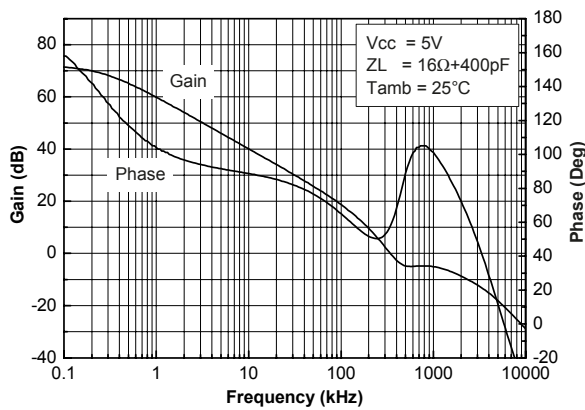

Figure 9. Open loop gain and phase vs. frequency
ZL = 16 Ω, Vcc = 2 V

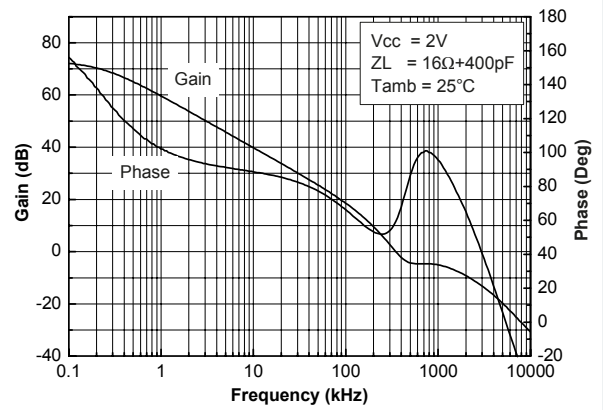

Figure 10. Open loop gain and phase vs. frequency
RL = 32 Ω

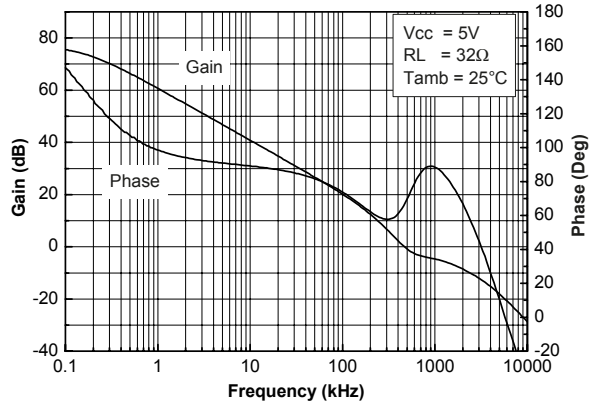

Figure 11. Open loop gain and phase vs. frequency
RL = 32 Ω, Vcc = 2 V

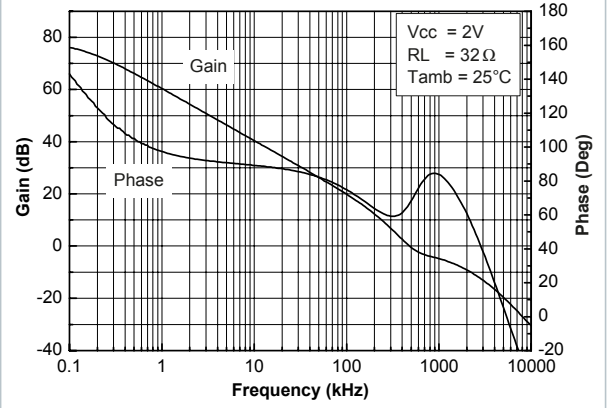

Figure 12. Open loop gain and phase vs. frequency
ZL = 32 Ω

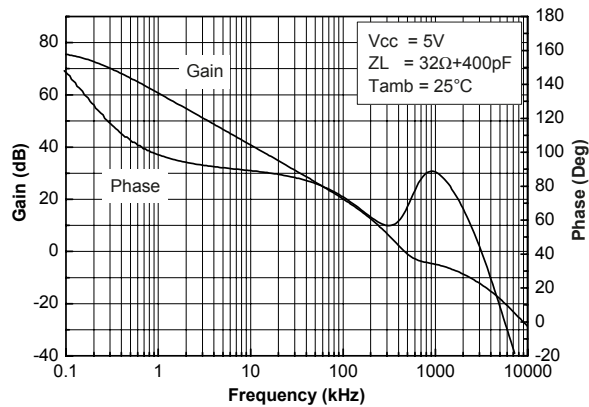

Figure 13. Open loop gain and phase vs. frequency
ZL = 32 Ω, Vcc = 2 V

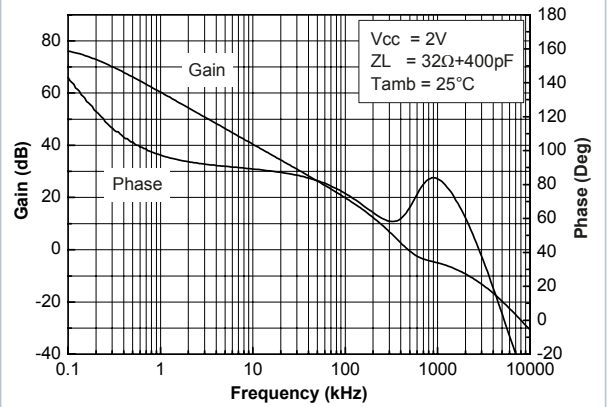

Figure 14. Current consumption vs. power supply voltage

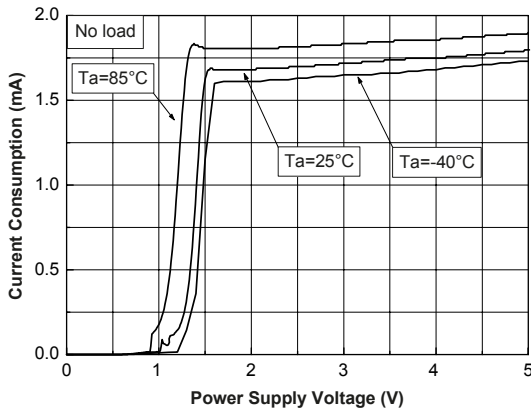

Figure 15. Current consumption vs. standby voltage Vcc = 5 V

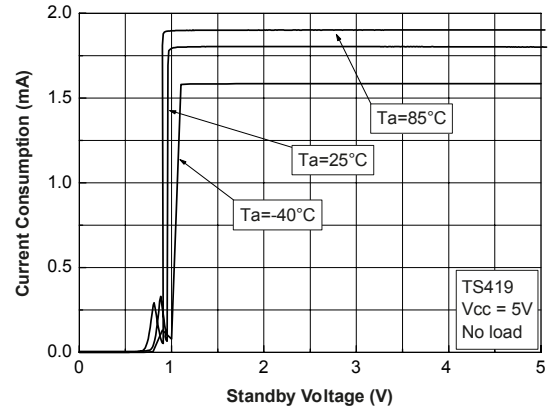

Figure 16. Current consumption vs. standby voltage Vcc = 3.3 V

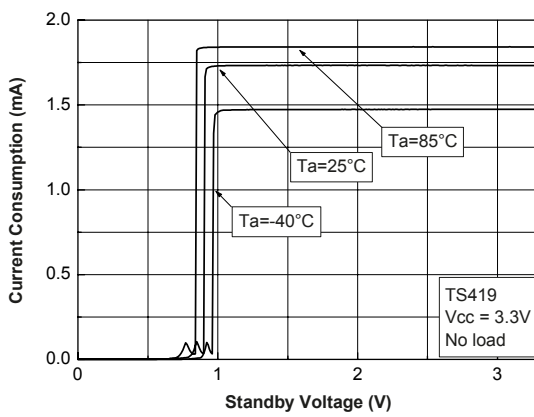

Figure 17. Current consumption vs. standby voltage Vcc = 2 V

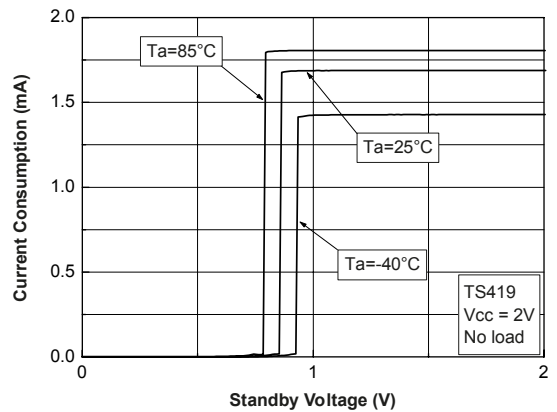

Figure 18. Current consumption vs. standby voltage $V_{CC} = 5\text{ V}$ (TS421)

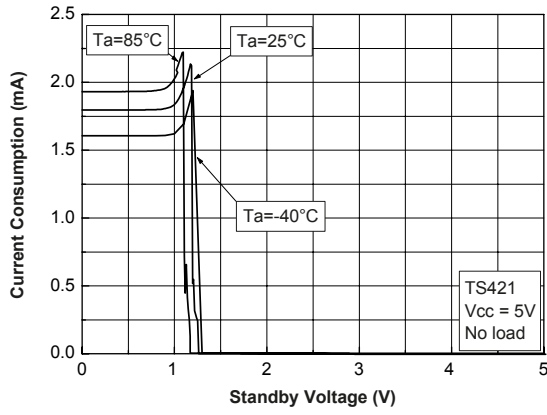

Figure 19. Current consumption vs. standby voltage $V_{CC} = 3.3\text{ V}$ (TS421)

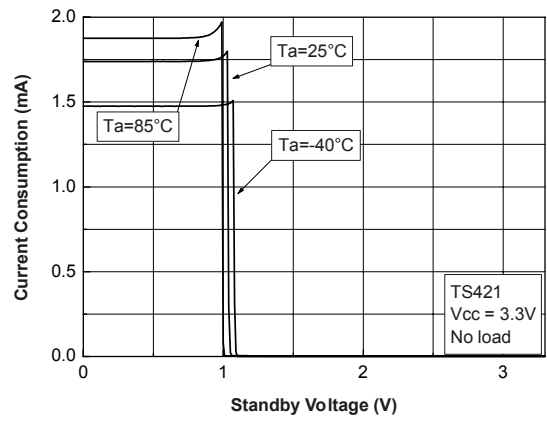

Figure 20. Current consumption vs. standby voltage $V_{CC} = 2\text{ V}$ (TS421)

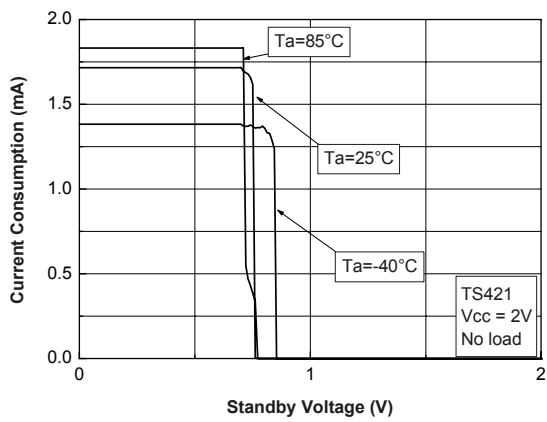

Figure 21. Output power vs. power supply voltage $R_L = 8\ \Omega$

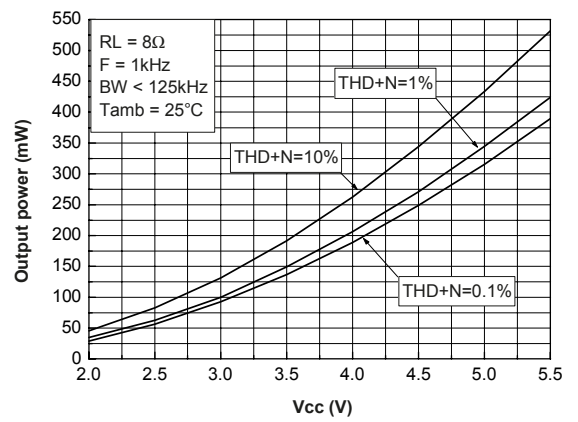

Figure 22. Output power vs. power supply voltage
RL = 16 Ω

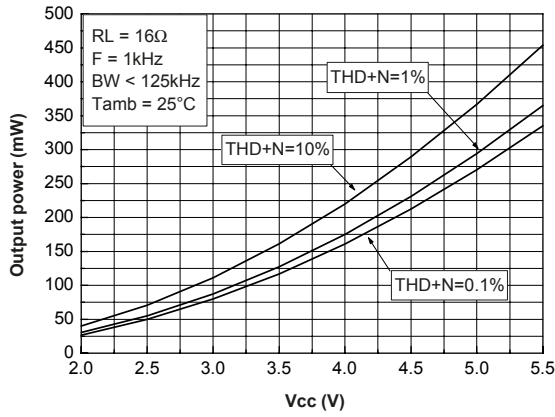

Figure 23. Output power vs. power supply voltage
RL = 32 Ω

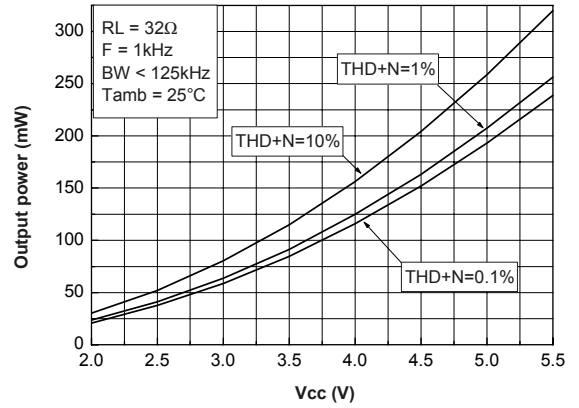

Figure 24. Output power vs. power supply voltage
RL = 64 Ω

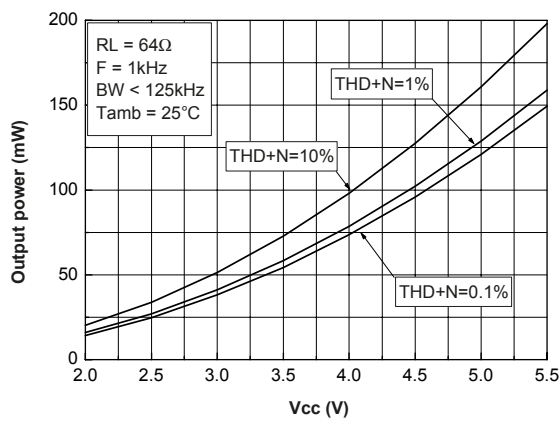

Figure 25. Output power vs. load resistor Vcc = 5 V

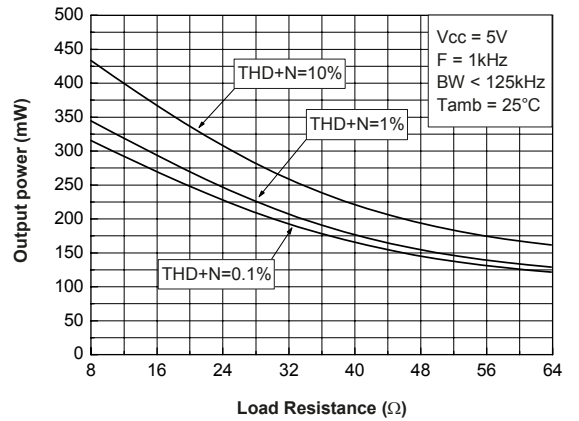

Figure 26. Output power vs. load resistor
V_{CC} = 3.3 V

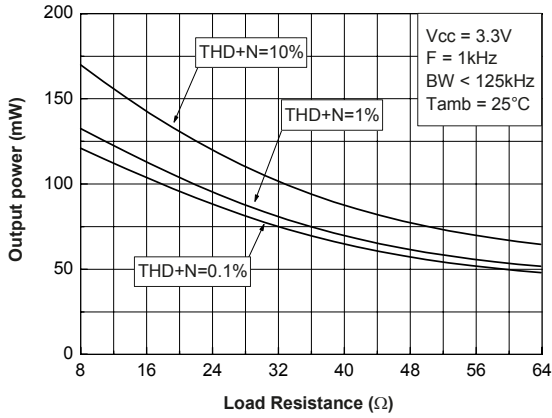

Figure 27. Output power vs. load resistor
V_{CC} = 2.5 V

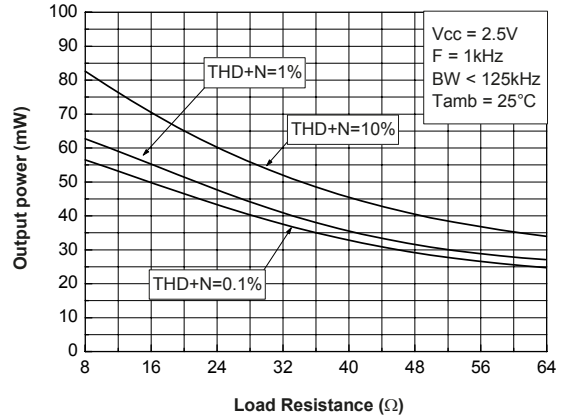

Figure 28. Output power vs. load resistor **V_{CC} = 2 V**

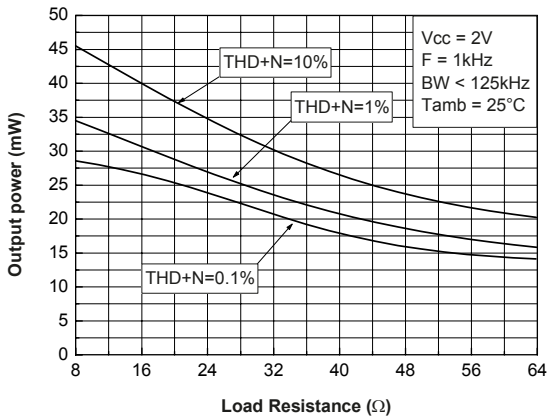

Figure 29. Power dissipation vs. output power
V_{CC} = 5 V

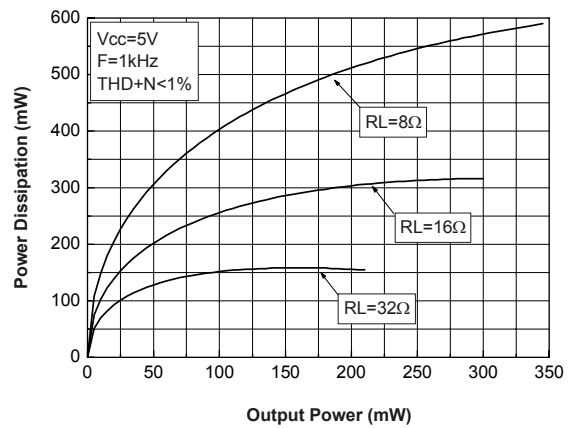

Figure 30. Power dissipation vs. output power
Vcc = 3.3 V

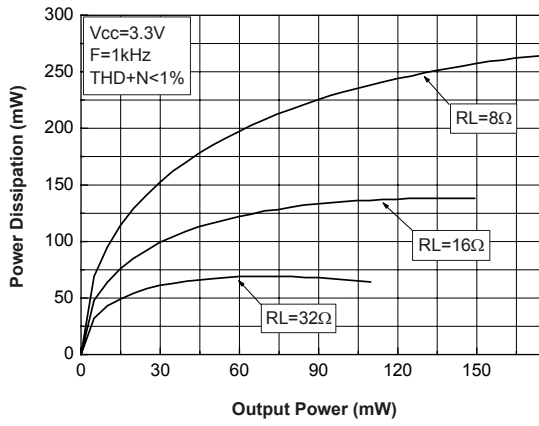

Figure 31. Power dissipation vs. output power
Vcc = 2.5 V

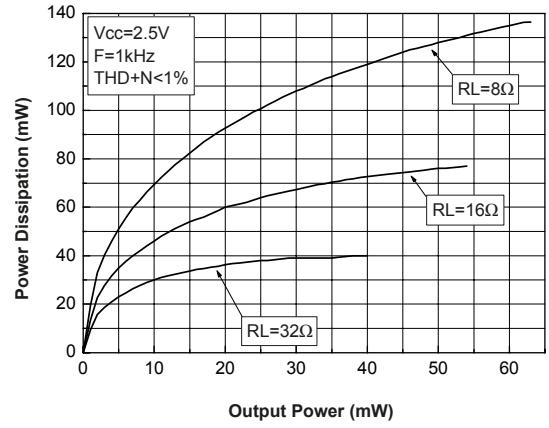

Figure 32. Power dissipation vs. output power
Vcc = 2 V

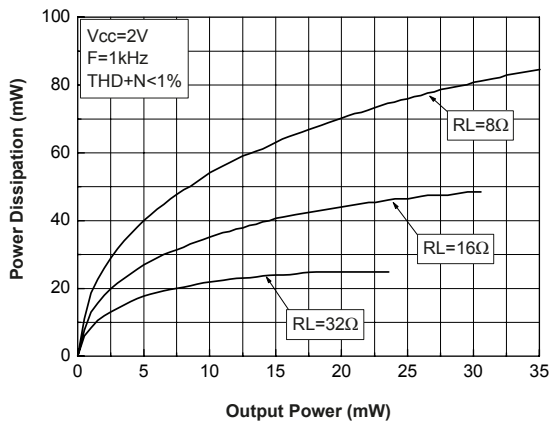

Figure 33. Power derating curves

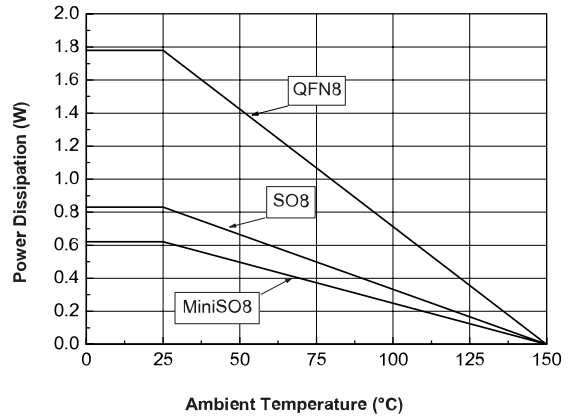

Figure 34. Output voltage swing for one Amp. vs. power supply voltage

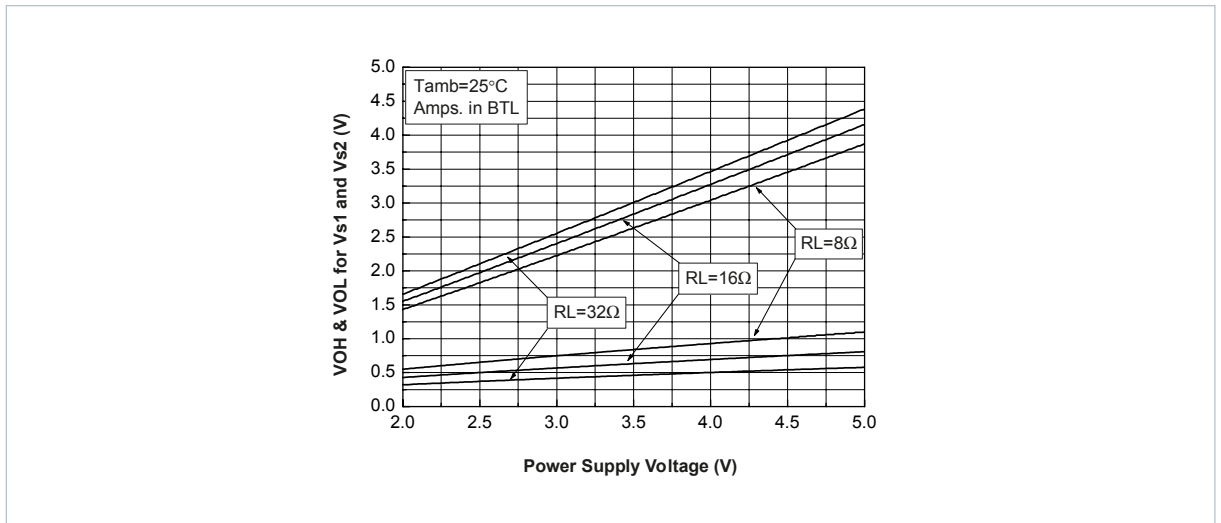

Figure 35. THD + N vs. output power RL = 8 Ω

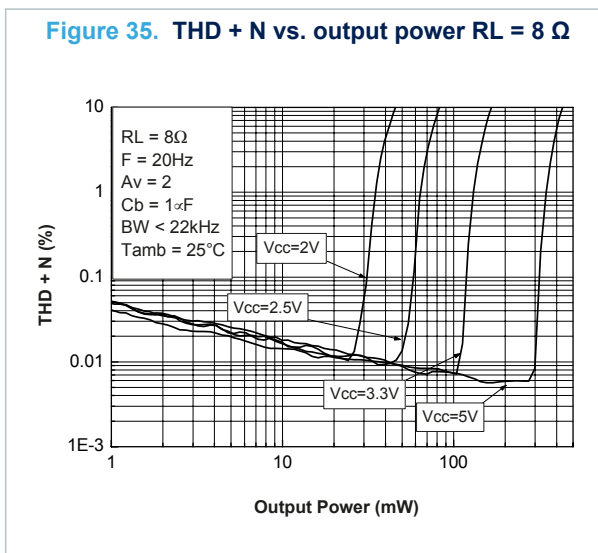

Figure 36. THD + N vs. output power RL = 16 Ω

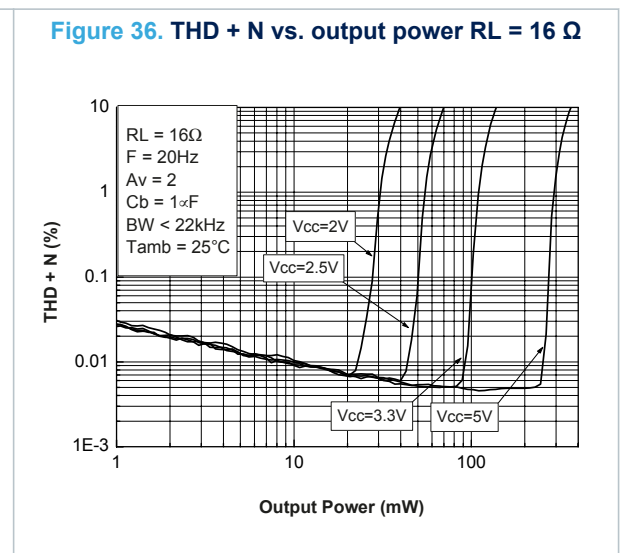

Figure 37. THD + N vs. output power $R_L = 32 \Omega$

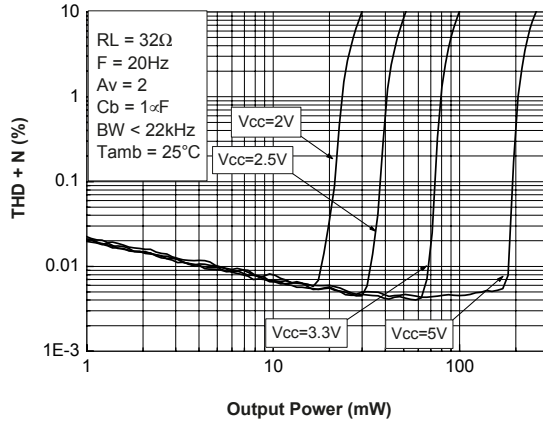

Figure 38. THD + N vs. output power $R_L = 8 \Omega$, $A_v = 2$

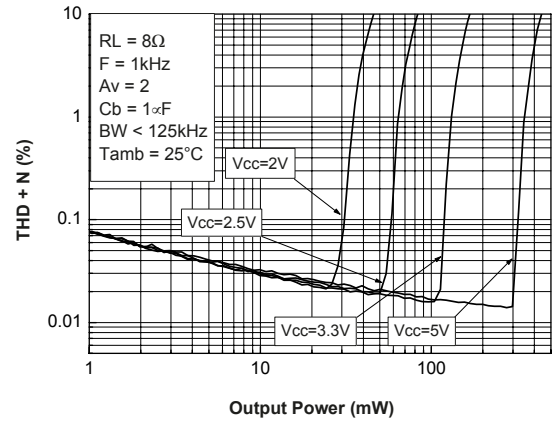

Figure 39. THD + N vs. output power $R_L = 16 \Omega$, $A_v = 2$

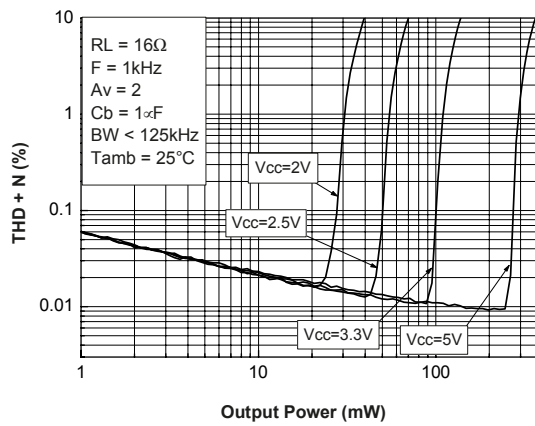

Figure 40. THD + N vs. output power $R_L = 32 \Omega$, $A_v = 2$

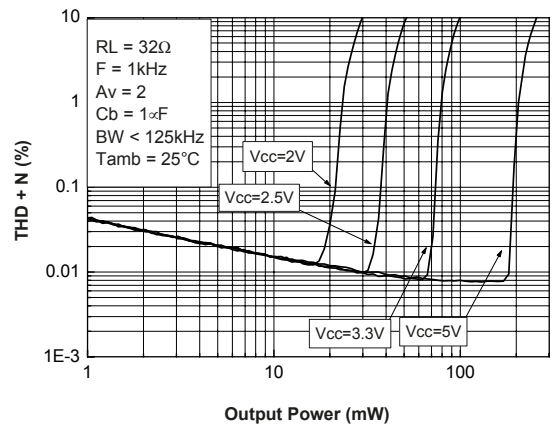

Figure 41. THD + N vs. output power RL = 8 Ω, Cb = 1 μF

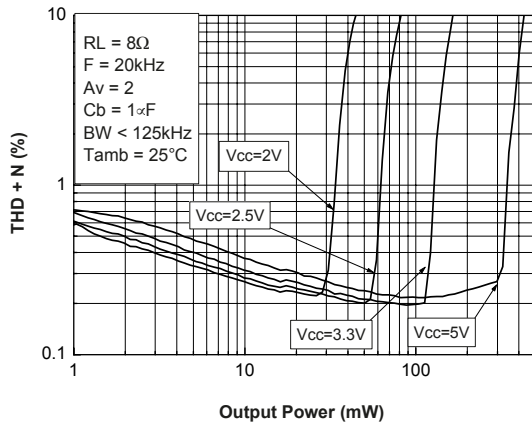

Figure 42. THD + N vs. output power RL = 16 Ω, Cb = 1 μF

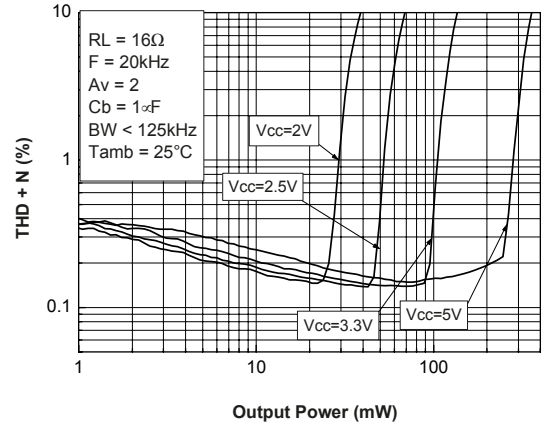

Figure 43. THD + N vs. output power RL = 32 Ω, Cb = 1 μF

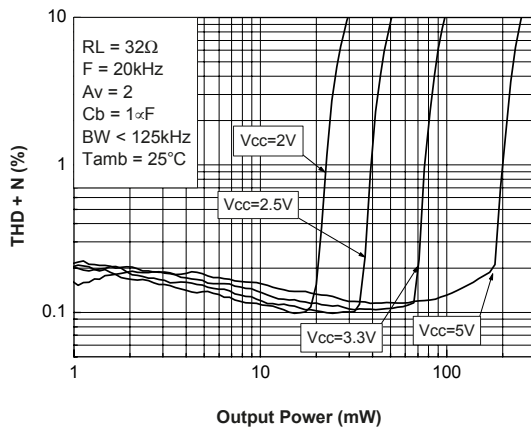

Figure 44. THD + N vs. frequency RL = 8 Ω

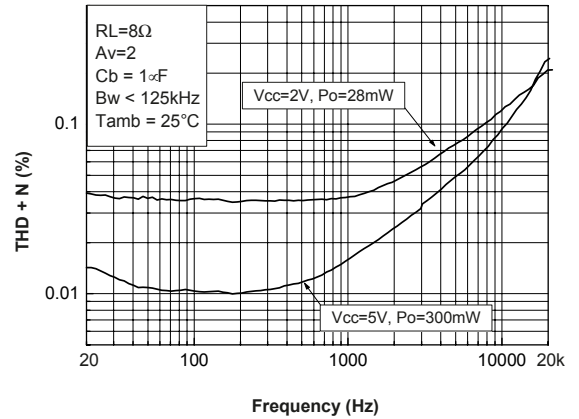

Figure 45. THD + N vs. frequency RL = 16 Ω

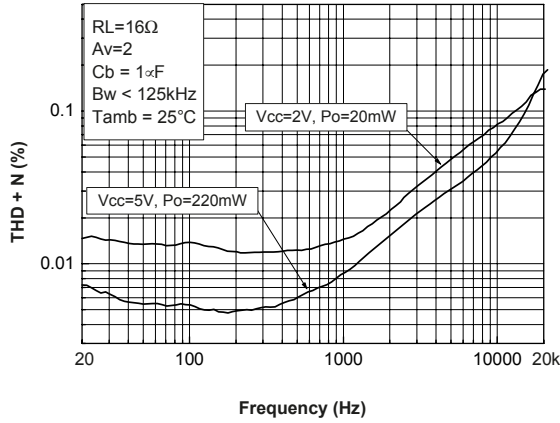

Figure 46. THD + N vs. frequency RL = 32 Ω

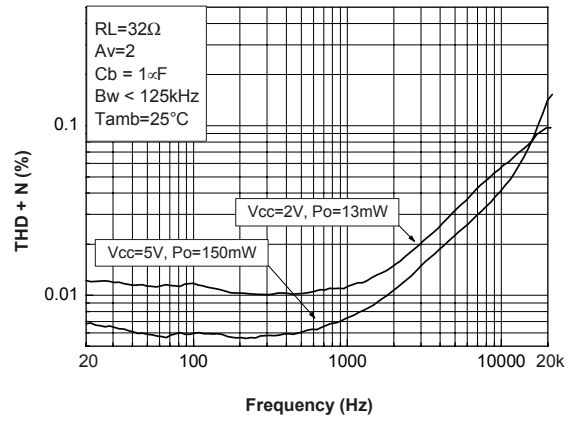

Figure 47. Signal to noise ratio vs. power supply voltage with unweighted filter (20 Hz to 20 kHz)

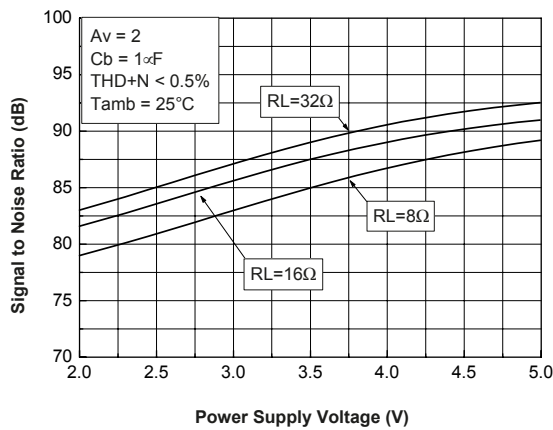

Figure 48. Signal to noise ratio vs. power supply voltage with weighted filter Type A

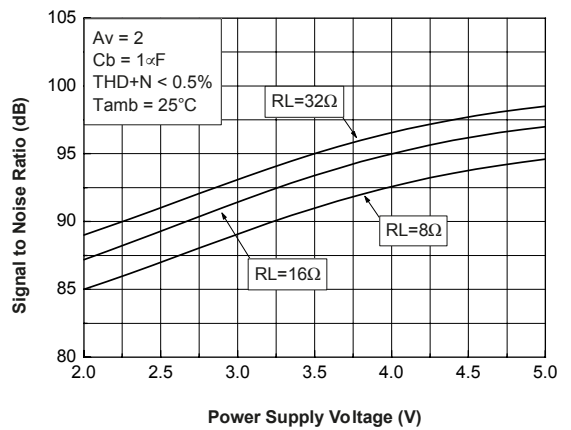

Figure 49. Noise floor Vcc = 5 V

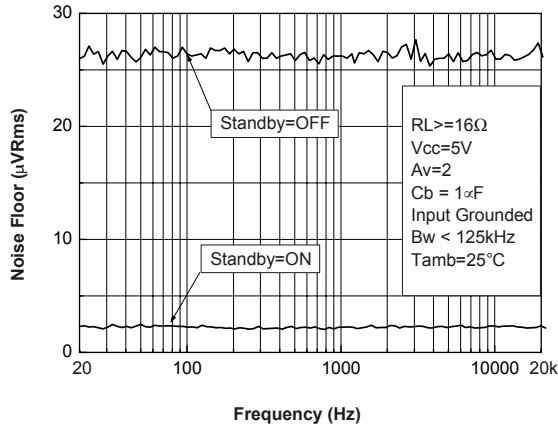

Figure 50. Noise floor Vcc = 2 V

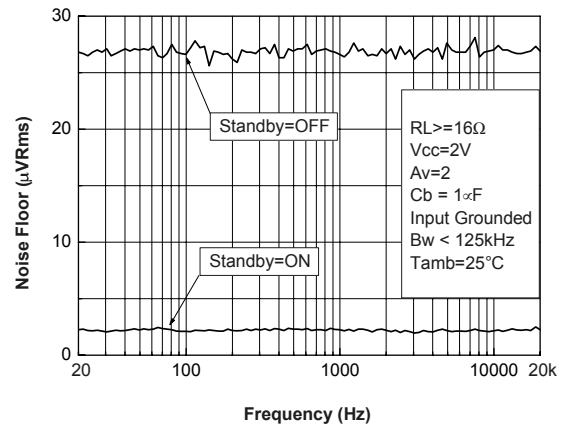

Figure 51. PSRR vs. input capacitor

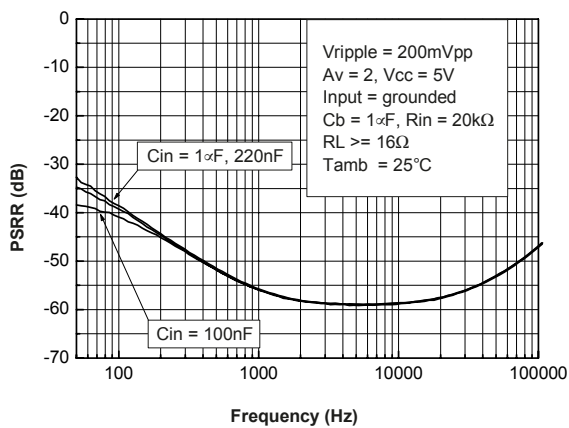

Figure 52. PSRR vs. power supply voltage

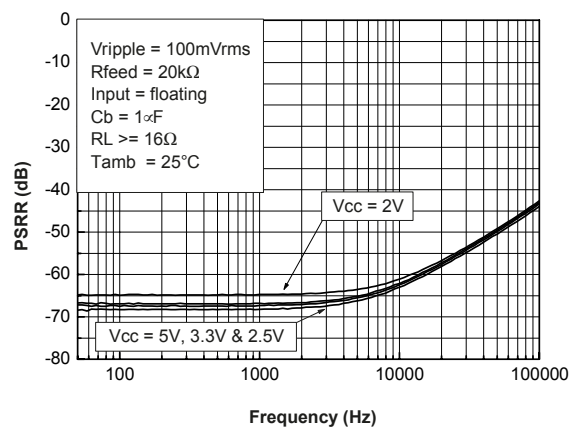

Figure 53. PSRR vs. bypass capacitor
Cb = Cin = 1 μ F

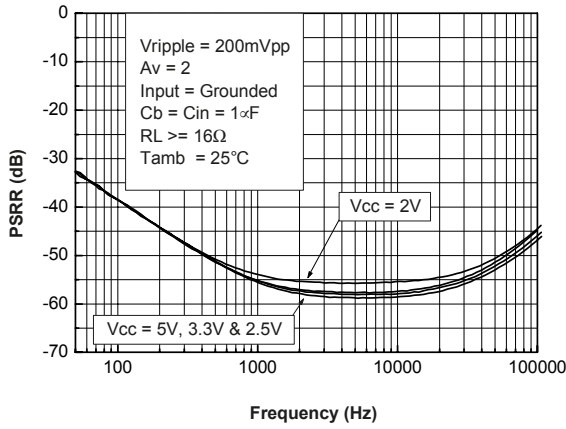

Figure 54. PSRR vs. bypass capacitor Cb = 4.7 μ F

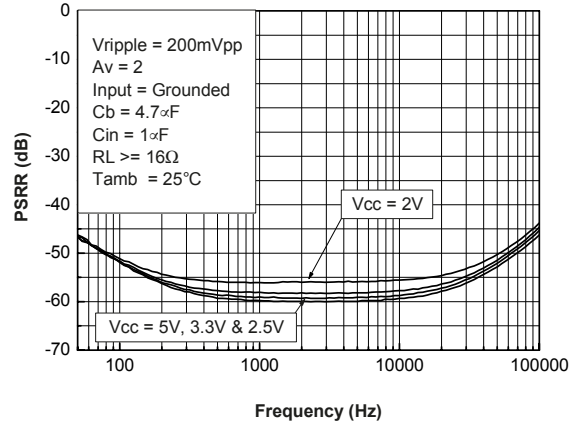

Figure 55. PSRR vs. bypass capacitor Cb = 10 μ F

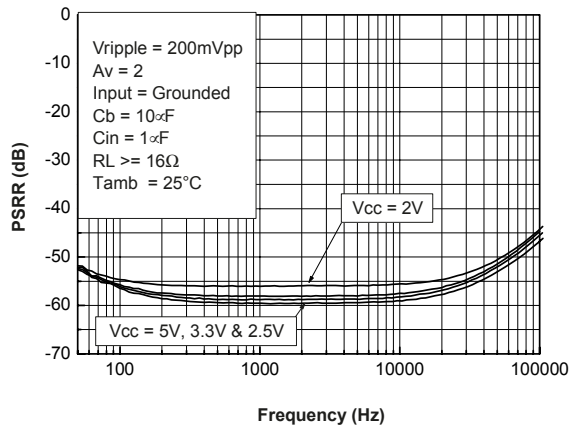

Figure 56. THD + N vs. output power RL = 8 Ω

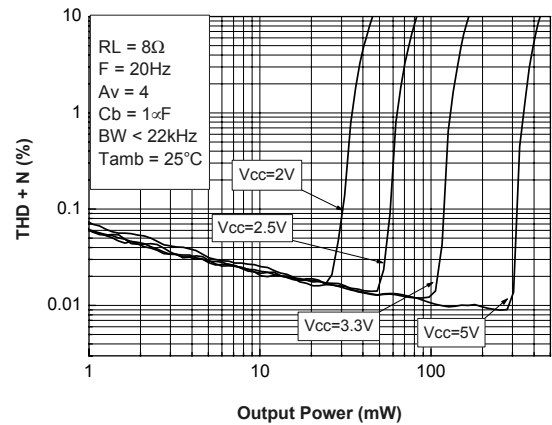

Figure 57. THD + N vs. output power RL = 16 Ω

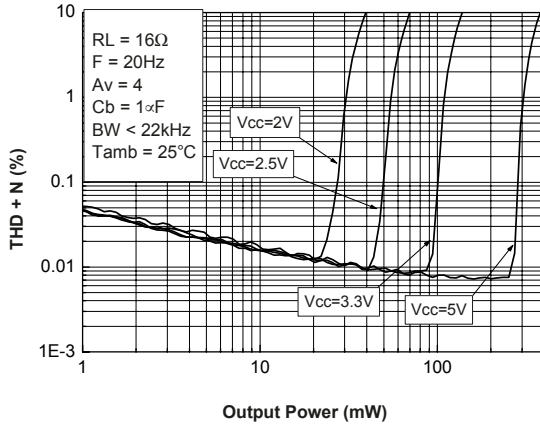

Figure 58. THD + N vs. output power RL = 32 Ω

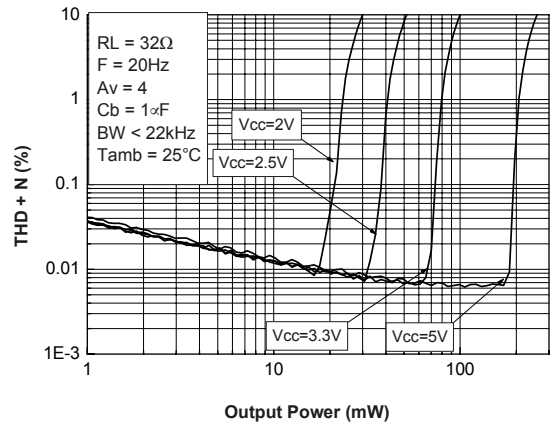

Figure 59. THD + N vs. output power RL = 8 Ω, Av = 4

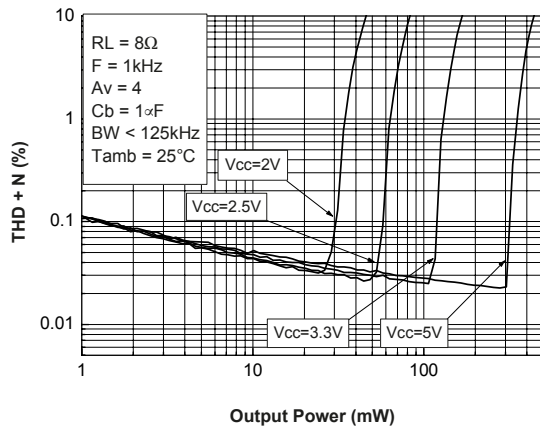

Figure 60. THD + N vs. output power RL = 16 Ω, Av = 4

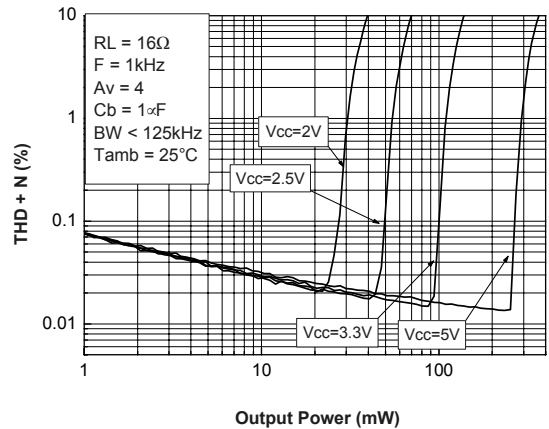

Figure 61. THD + N vs. output power $R_L = 32 \Omega$, $A_v = 4$

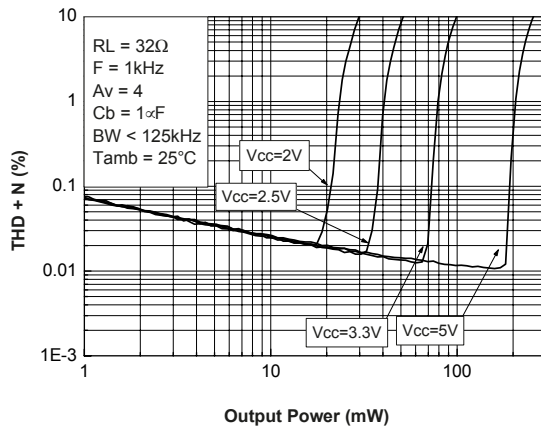

Figure 62. THD + N vs. output power $R_L = 8 \Omega$

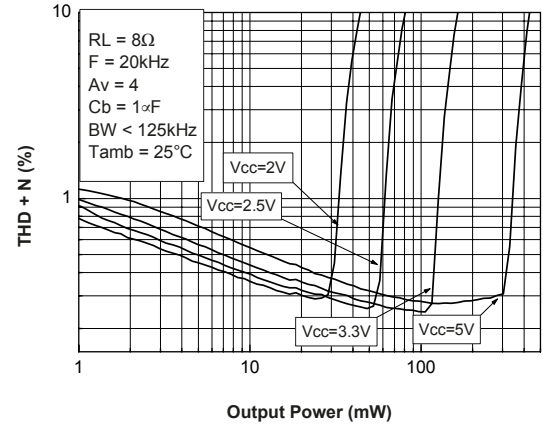

Figure 63. THD + N vs. output power $R_L = 16 \Omega$

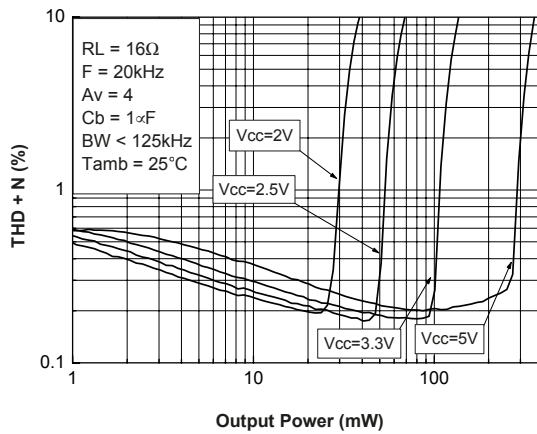

Figure 64. THD + N vs. output power $R_L = 32 \Omega$

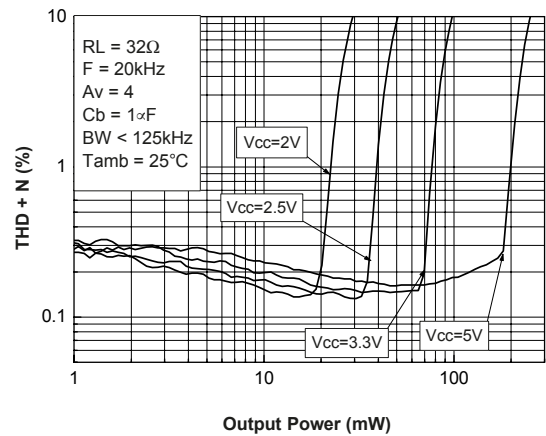

Figure 65. THD + N vs. frequency RL = 8 Ω

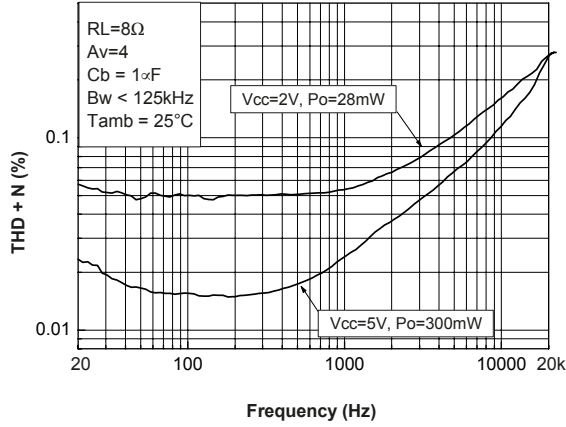

Figure 66. THD + N vs. frequency RL = 16 Ω

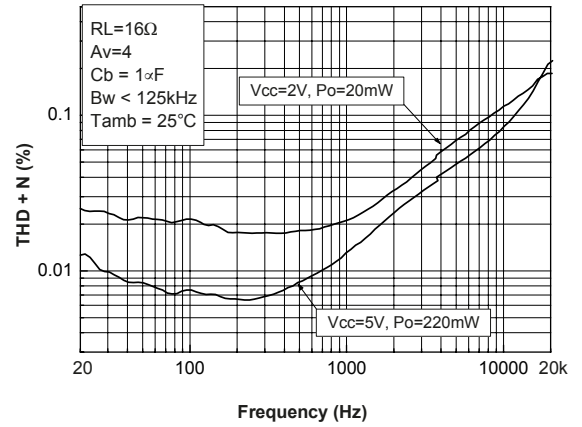

Figure 67. THD + N vs. frequency RL = 32 Ω

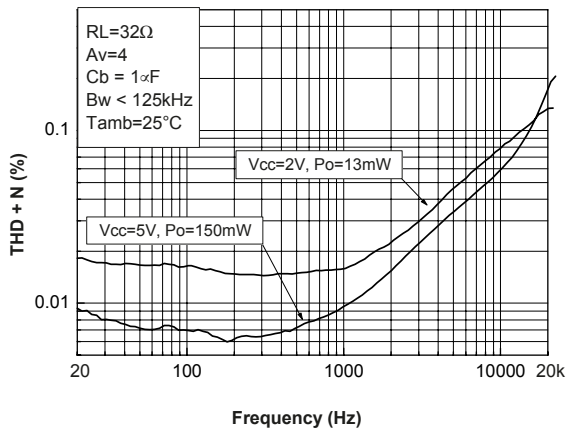

Figure 68. Signal-to-noise ratio vs. power supply voltage with unweighted filter (20 Hz to 20 kHz)

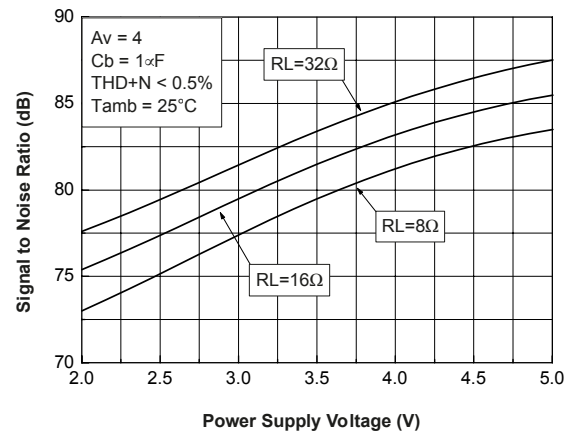

Figure 69. Signal-to-noise ratio vs power supply voltage with weighted filter Type A

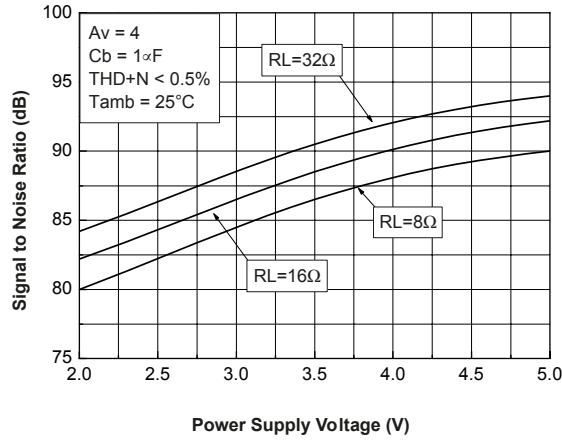

Figure 70. Noise floor $V_{cc} = 5 V$

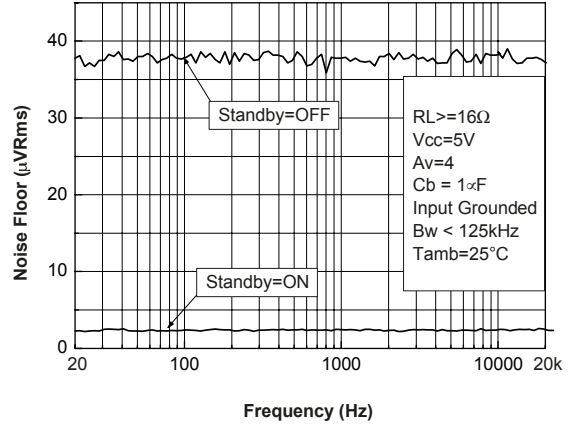

Figure 71. Noise floor $V_{cc} = 2 V$

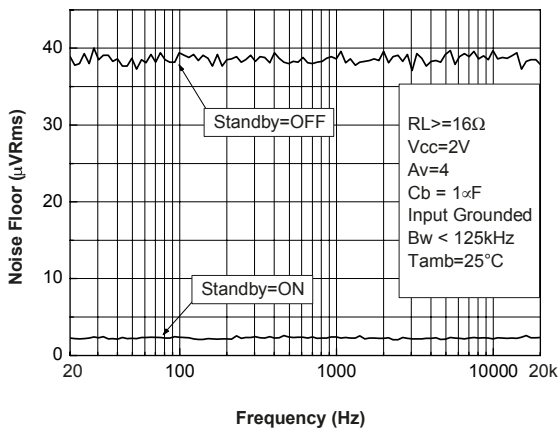

Figure 72. PSRR vs. power supply voltage

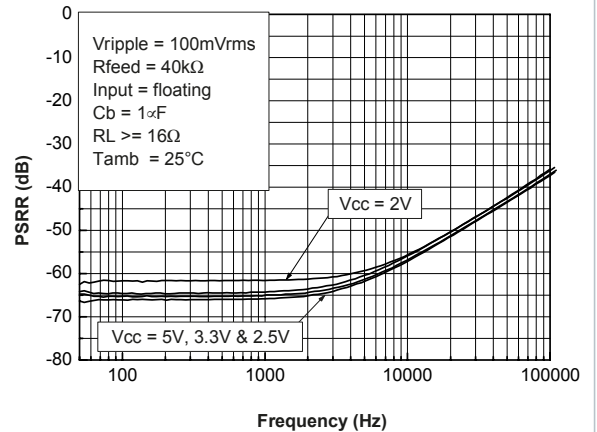

Figure 73. PSRR vs. input capacitor

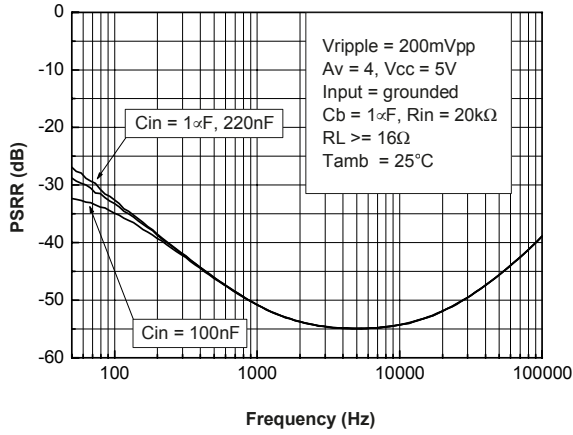

Figure 74. PSRR vs. bypass capacitor
Cb = Cin = 1 µF

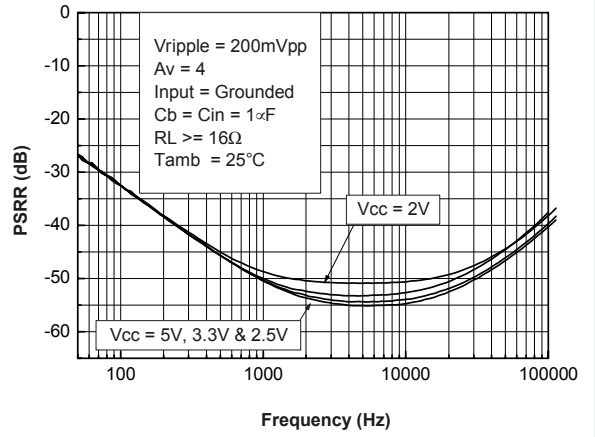

Figure 75. PSRR vs. bypass capacitor
Cb = Cin = 4.7 µF

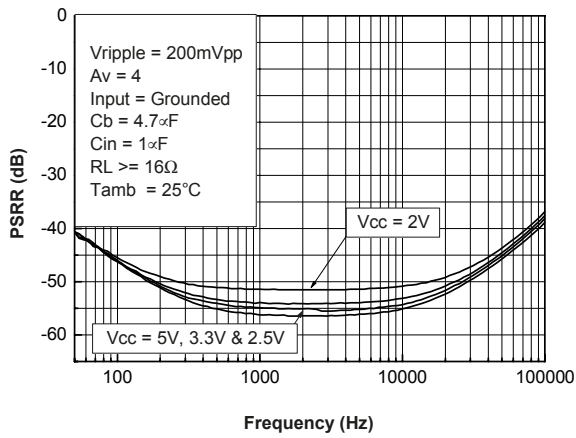

Figure 76. PSRR vs. bypass capacitor
Cb = Cin = 10 µF

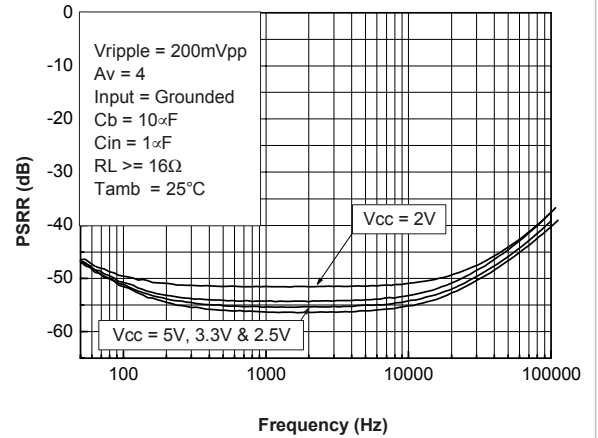

Figure 77. THD + N vs. output power RL = 8 Ω

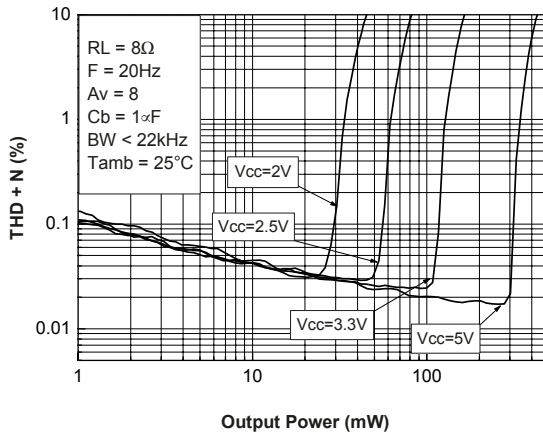

Figure 78. THD + N vs. output power RL = 16 Ω

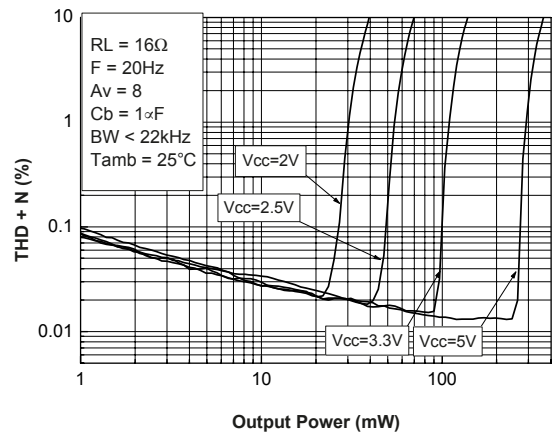

Figure 79. THD + N vs. output power RL = 32 Ω

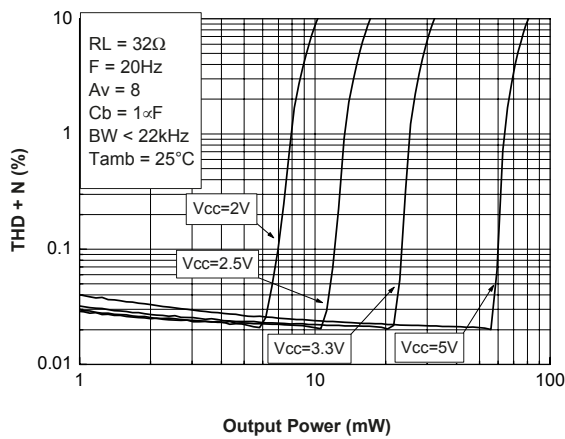

Figure 80. THD + N vs. output power RL = 8 Ω, Av = 8

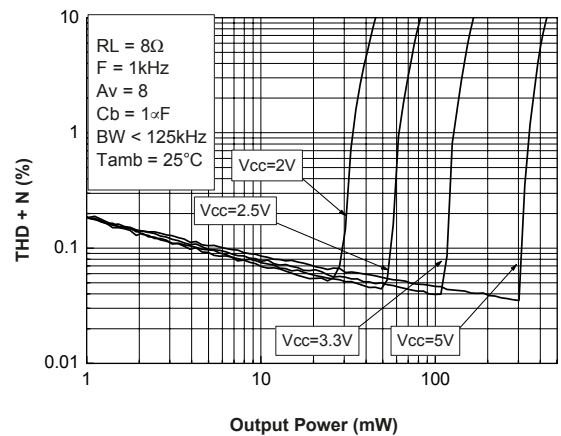

Figure 81. THD + N vs. output power RL = 16 Ω, Av = 8

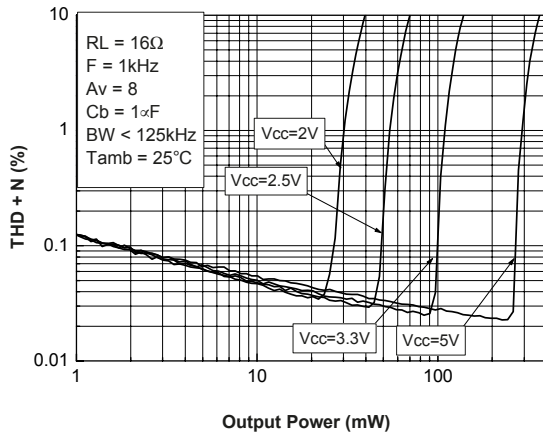

Figure 82. THD + N vs. output power RL = 32 Ω, Av = 8

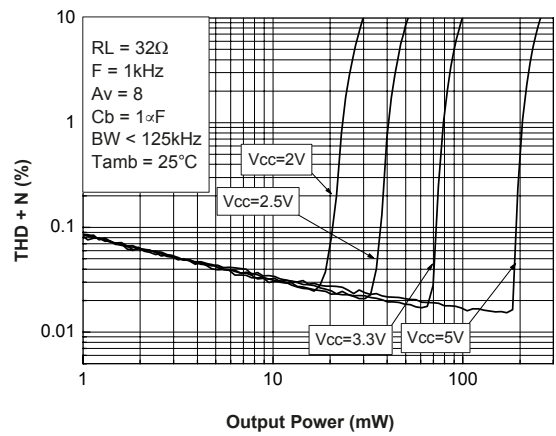

Figure 83. THD + N vs. output power RL = 8 Ω, Cb = 1 μF

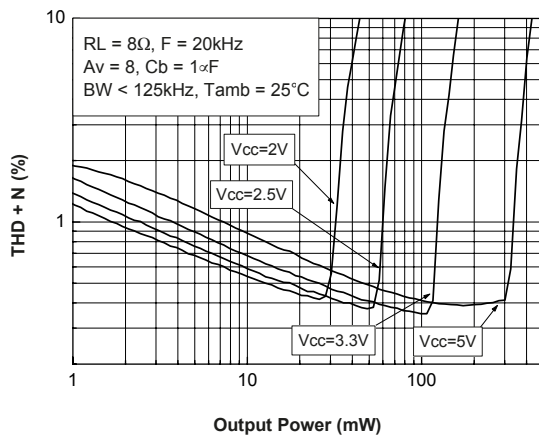

Figure 84. THD + N vs. output power RL = 16 Ω, Cb = 1 μF

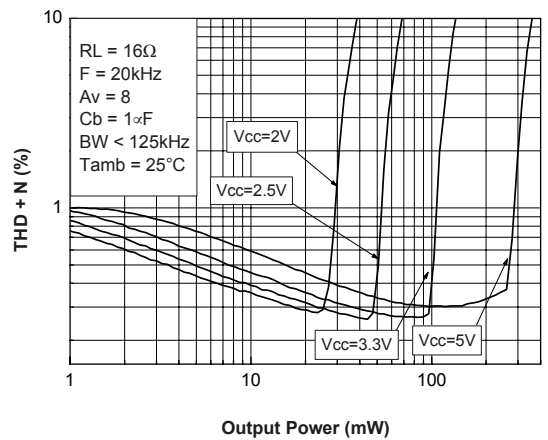

Figure 85. THD + N vs. output power RL = 32 Ω, Cb = 1 μF

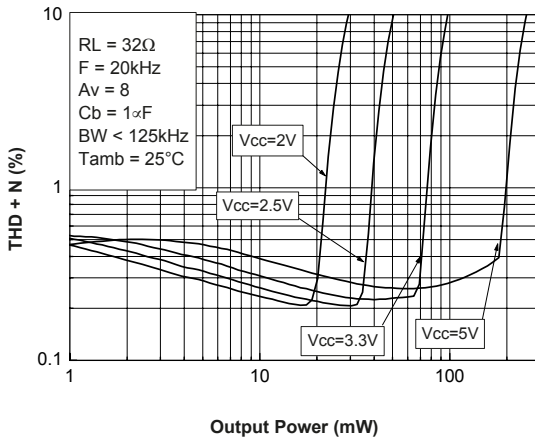

Figure 86. THD + N vs. frequency RL = 8 Ω

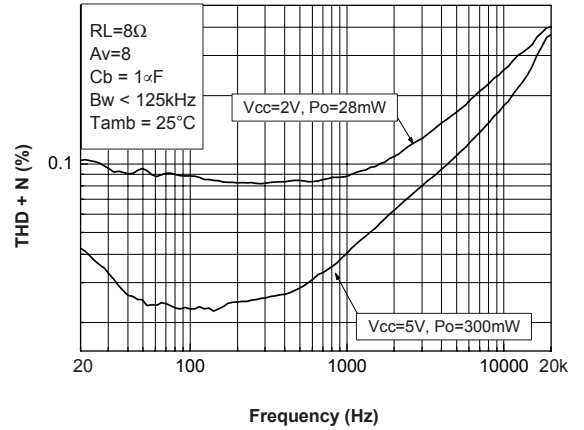

Figure 87. THD + N vs. frequency RL = 16 Ω

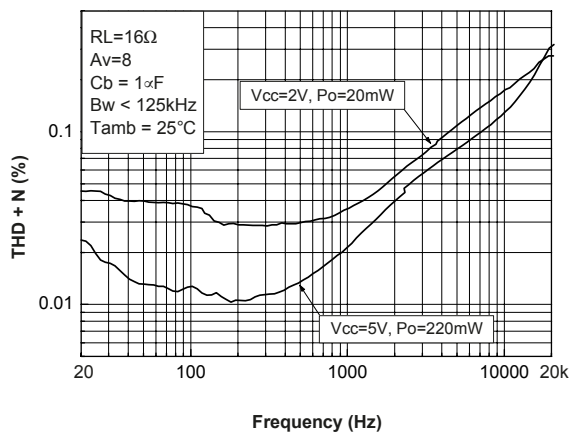

Figure 88. THD + N vs. frequency RL = 32 Ω

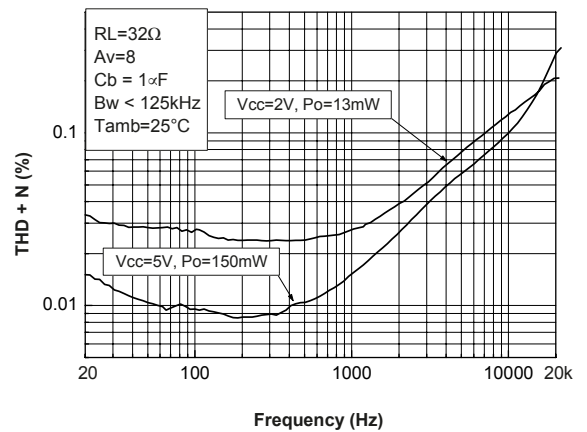

Figure 89. Signal to noise ratio vs. power supply voltage with unweighted filter (20 Hz to 20 kHz)

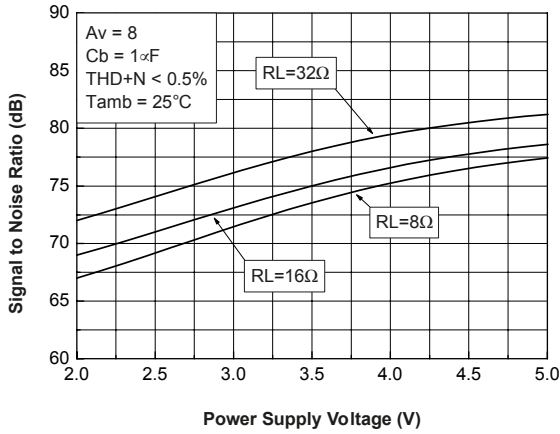

Figure 90. Signal to noise ratio vs. power supply voltage with weighted filter Type A

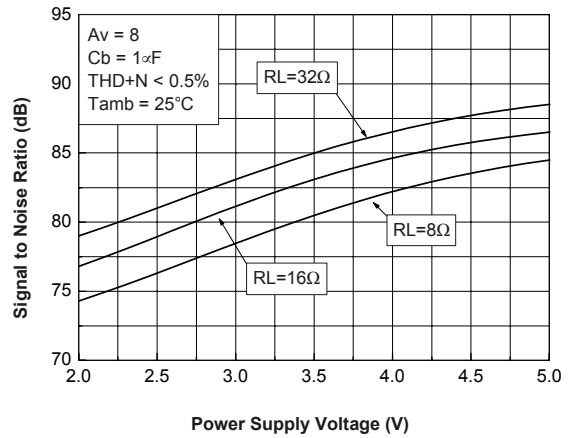

Figure 91. Noise floor Vcc = 5 V

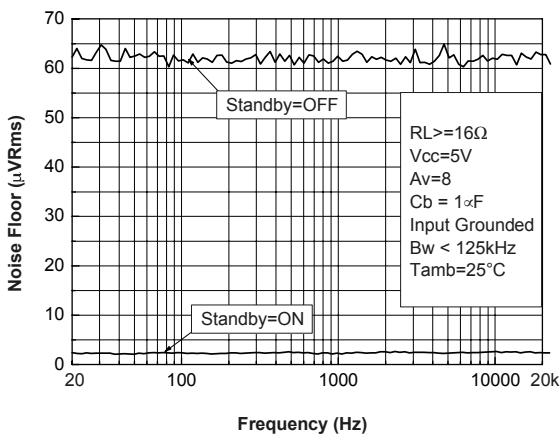

Figure 92. Noise floor Vcc = 2 V

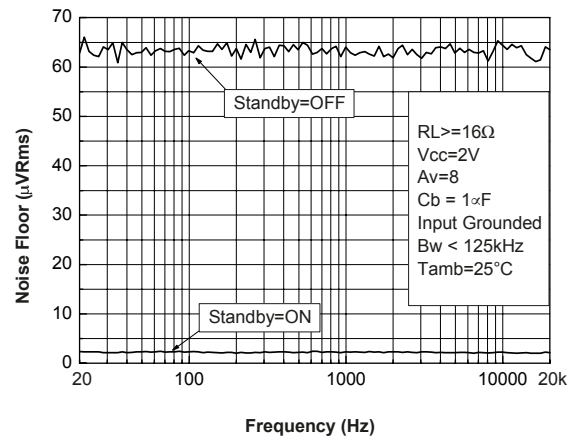

Figure 93. PSRR vs. power supply voltage

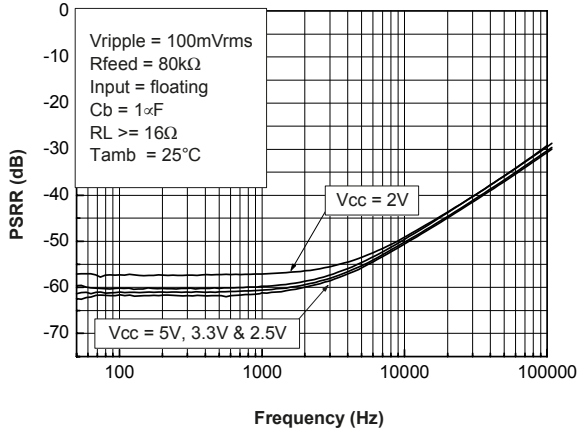

Figure 94. PSRR vs. input capacitor

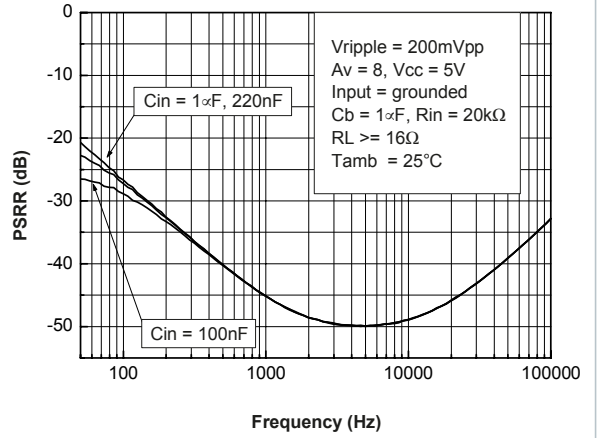

Figure 95. PSRR vs. bypass capacitor
Cb = Cin = 1 μ F

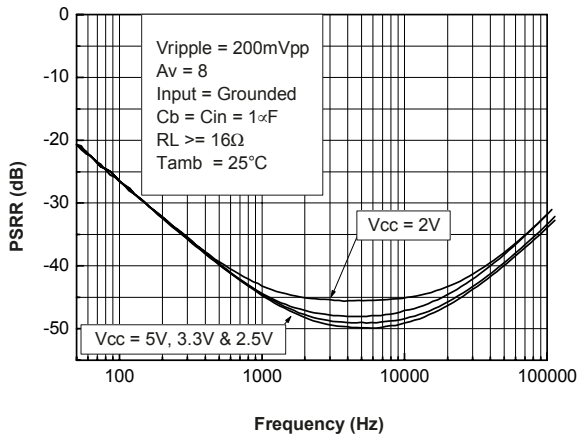

Figure 96. PSRR vs. bypass capacitor Cb = 4.7 μ F

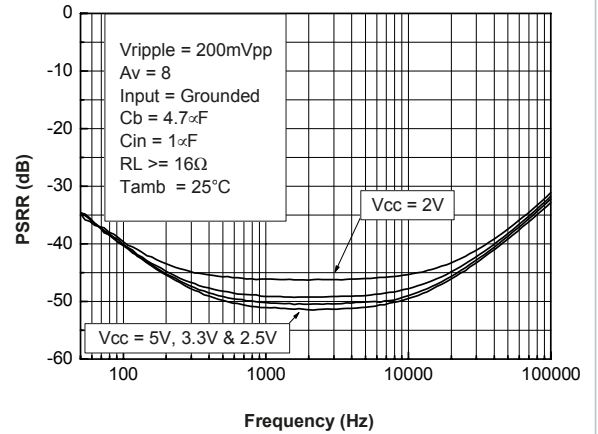
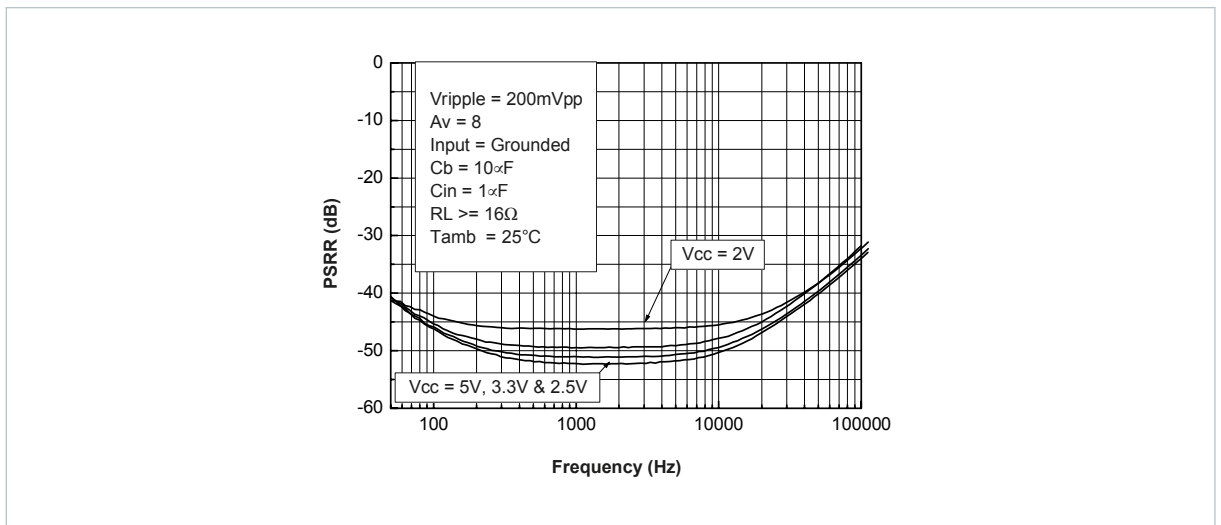

Figure 97. PSRR vs. bypass capacitor $C_b = 1 \mu\text{F}$



5 Application information

5.1 BTL configuration principle

The TS419 and TS421 are monolithic power amplifiers with a BTL output type. BTL (Bridge Tied Load) means that each end of the load is connected to two single-ended output amplifiers. Thus, we have:

Single ended output 1 = $V_{out1} = V_{out}$ (V)

Single ended output 2 = $V_{out2} = -V_{out}$ (V)

And $V_{out1} - V_{out2} = 2V_{out}$ (V)

The output power is:

$P_{out} = (2V_{out_{RMS}})^2 / R_L$ (W)

For the same power supply voltage, the output power in BTL configuration is four times higher than the output power in single ended configuration.

5.2 Gain in typical application schematic

In flat region (no effect of C_{in}), the output voltage of the first stage is:

$$V_{out} = -V_{in} \frac{R_{feed}}{R_{in}} \quad (V) \quad (1)$$

For the second stage : $V_{out2} = -V_{out1}$ (V)

The differential output voltage is:

$$V_{out2} - V_{out1} = 2V_{in} \frac{R_{feed}}{R_{in}} \quad (V) \quad (2)$$

The differential gain named gain (G_v) for more convenient usage is:

$$G_v = \frac{V_{out2} - V_{out1}}{V_{in}} = 2 \frac{R_{feed}}{R_{in}} \quad (3)$$

Remark : V_{out2} is in phase with V_{in} and V_{out1} is 180° phased with V_{in} . It means that the positive terminal of the loud speaker should be connected to V_{out2} and the negative to V_{out1} .

5.3 Low and high frequency response

In low frequency region, the effect of C_{in} starts. C_{in} with R_{in} forms a high pass filter with a -3 dB cut-off frequency

$$F_{CL} = \frac{1}{2\pi R_{in} C_{in}} \quad (Hz)$$

In high frequency region, you can limit the bandwidth by adding a capacitor (C_{feed}) in parallel on R_{feed} . Its form a low pass filter with a -3 dB cut-off frequency.

$$F_{CH} = \frac{1}{2\pi R_{feed} C_{feed}} \quad (Hz)$$

5.4 Power dissipation and efficiency

Hypothesis:

- Voltage and current in the load are sinusoidal (V_{out} and I_{out})
- Supply voltage is a pure DC source (V_{cc})

Regarding the load we have:

$$V_{OUT} = V_{PEAK} \sin \omega t(t) \quad (4)$$

and

$$I_{OUT} = \frac{V_{OUT}}{R_L} \quad (A) \quad (5)$$

$$P_{OUT} = \frac{V_{PEAK}^2}{2R_L} (W) \quad (6)$$

Then, the average current delivered by the supply voltage is:

$$I_{CC_{AVG}} = 2 \frac{V_{PEAK}}{\pi R_L} (A) \quad (7)$$

The power delivered by the supply voltage is $P_{supply} = V_{CC} I_{CC_{AVG}}$ (W)

Then, the power dissipated by the amplifier is $P_{diss} = P_{supply} - P_{out}$ (W)

$$P_{diss} = \frac{2\sqrt{2}V_{CC}}{\pi R_L} \sqrt{P_{OUT}} - P_{OUT} (W) \quad (8)$$

and the maximum value is obtained when:

$$\frac{\partial P_{diss}}{\partial P_{OUT}} = 0 \quad (9)$$

and its value is:

$$P_{dissmax} = \frac{2V_{CC}^2}{\pi^2 R_L} (W) \quad (10)$$

Remark : This maximum value is only depending on power supply voltage and load values.

The efficiency is the ratio between the output power and the power supply

$$\eta = \frac{P_{OUT}}{P_{supply}} = \frac{\pi V_{PEAK}}{4V_{CC}} \quad (11)$$

The maximum theoretical value is reached when

$V_{peak} = V_{CC}$, so

$$\frac{\pi}{4} = 78.5\% \quad (12)$$

5.5 Decoupling of the circuit

Two capacitors are needed to bypass properly the TS419/TS421. A power supply bypass capacitor C_S and a bias voltage bypass capacitor C_B .

C_S has particular influence on the THD+N in the high frequency region (above 7 kHz) and an indirect influence on power supply disturbances.

With 1 μ F, you can expect similar THD+N performances to those shown in the datasheet.

In the high frequency region, if C_S is lower than 1 μ F, it increases THD+N and disturbances on the power supply rail are less filtered.

On the other hand, if C_S is higher than 1 μ F, those disturbances on the power supply rail are more filtered.

C_B has an influence on THD+N at lower frequencies, but its function is critical to the final result of PSRR (with input grounded and in the lower frequency region).

If C_B is lower than 1 μ F, THD+N increases at lower frequencies and PSRR worsens.

If C_B is higher than 1 μ F, the benefit on THD+N at lower frequencies is small, but the benefit to PSRR is substantial.

Note: *that C_{IN} has a non-negligible effect on PSRR at lower frequencies. The lower the value of C_{IN} , the higher the PSRR.*

5.6 Wake-up time: T_{WU}

When standby is released to put the device ON, the bypass capacitor C_B will not be charged immediately. As C_B is directly linked to the bias of the amplifier, the bias will not work properly until the C_B voltage is correct. The time to reach this voltage is called wake-up time or T_{WU} and typically equal to:

$T_{WU} = 0.15 \times C_B$ (s) with C_B in μ F.

Due to process tolerances, the range of the wake-up time is:
 $0.12 \times C_B < T_{WU} < 0.18 \times C_B$ (s) with C_B in μF

Note: When the standby command is set, the time to put the device in shutdown mode is a few microseconds.

5.7 Pop performance

Pop performance is intimately linked with the size of the input capacitor C_{IN} and the bias voltage bypass capacitor C_B .

The size of C_{IN} is dependent on the lower cut-off frequency and PSRR values requested. The size of C_B is dependent on THD+N and PSRR values requested at lower frequencies.

Moreover, C_B determines the speed with which the amplifier turns ON. The slower the speed is, the softer the turn ON noise is.

The charge time of C_B is directly proportional to the internal generator resistance 150 k Ω .

Then, the charge time constant for C_B is

$$\tau_B = 150 \text{ k}\Omega \times C_B \text{ (s)}$$

As C_B is directly connected to the non-inverting input (pin 2 & 3) and if we want to minimize, in amplitude and duration, the output spike on V_{out1} (pin 5), C_{IN} must be charged faster than C_B . The equivalent charge time constant of C_{IN} is:

$$\tau_{IN} = (R_{in} + R_{feed}) \times C_{IN} \text{ (s)}$$

Thus we have the relation:

$$\tau_{IN} < \tau_B \text{ (s)}$$

Proper respect of this relation allows to minimize the pop noise.

Remark : Minimizing C_{IN} and C_B benefits both the pop phenomena, and the cost and size of the application.

5.8 Application : Differential inputs BTL power amplifier

The schematic on figure 98, shows how to design the TS419/21 to work in a differential input mode.

The gain of the amplifier is:

$$G_{VDIFF} = 2 \frac{R_2}{R_1} \quad (13)$$

In order to reach optimal performances of the differential function, R_1 and R_2 should be matched at 1% max.

Figure 98. Differential input amplifier configuration

Input capacitance C can be calculated by the following formula using the -3 dB lower frequency required. (F_L is the lower frequency required).

$$C \approx \frac{1}{2\pi R_1 F_L} \text{ (F)} \quad (14)$$

Note : This formula is true only if:

$$F_{CB} = \frac{1}{942000 \times C_B} \text{ (Hz)} \quad (15)$$

is ten times lower than F_L .

The following bill of material is an example of a differential amplifier with a gain of 2 and a -3 dB lower cutoff frequency of about 80 Hz.

Table 8. Components

Designator	Part type
R1	20 k / 1%
R2	20 k / 1%
C	100 nF
$C_B = C_S$	1 μ F
U1	TS419/21

6 Package information

In order to meet environmental requirements, ST offers these devices in different grades of **ECOPACK** packages, depending on their level of environmental compliance. ECOPACK specifications, grade definitions and product status are available at: www.st.com. ECOPACK is an ST trademark.

6.1 MiniSO-8 mechanical data

Table 9. MiniSO-8 mechanical data

Dim.	mm.			inch.		
	Min.	Typ.	Max.	Min.	Typ.	Max.
A			1.1			0.043
A1	0.05	0.10	0.15	0.002	0.004	0.005
A2	0.78	0.86	0.94	0.031	0.031	0.037
b	0.25	0.33	0.4Q	0.010	0.13	0.013
c	0.13	0.16	0.23	0.005	0.007	0.009
D	2.90	3.00	3.10	0.114	0.118	0.122
E	4.75	4.90	5.05	0.187	0.193	0.199
E1	2.90	3.00	3.10	0.114	0.118	0.122
e		0.65			0.026	
K	0°		6°	0°		6°
L	0.40	0.55	0.70	0.016	0.022	0.028
L1			0.10			0.004

Figure 99. MiniSO-8 drawing

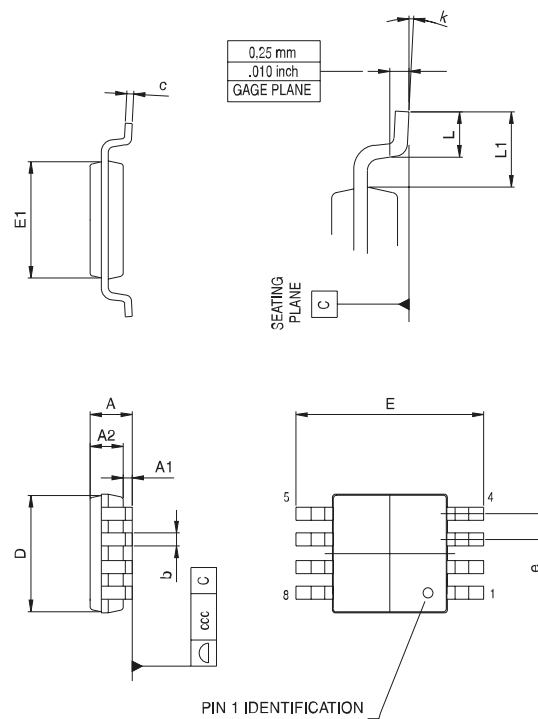

6.2 DFN8 (3x3) mechanical data

Table 10. DFN8 (3x3) mechanical data

Dim.	mm.			inch.		
	Min.	Typ.	Max.	Min.	Typ.	Max.
A	0.80	0.90	1.00	31.5	35.4	39.4
A1		0.02	0.05		0.8	2.0
A2		0.70			27.6	
A3		0.20			7.9	
b	0.18	0.23	0.30	7.1	9.1	11.8
D		3.00			118.1	
D2	2.23	2.38	2.48	87.8	93.7	97.7
E		3.00			118.1	
E2	1.49	1.64	1.74	58.7	64.6	68.5
e		0.50			19.7	
L	0.30	0.40	0.50	11.8	15.7	19.7

Figure 100. DFN8 (3x3) drawing

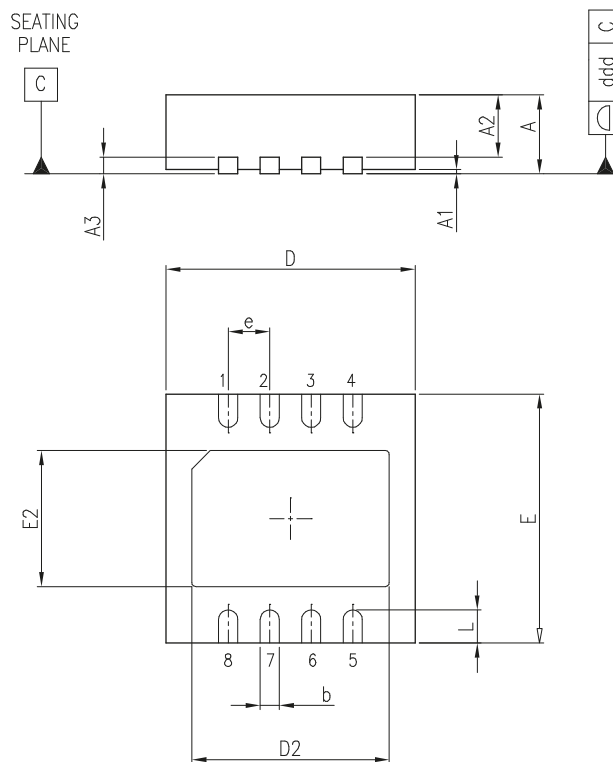

7 Ordering information

Table 11. Order codes

Order code	Temperature range	Package	Packing	Marking
TS419IST	-40°C to 85°C	miniSO8	Tape and reel	K19A
TS421IQT		DFN8		K21A

Revision history

Table 12. Document revision history

Date	Revision	Changes
06-Feb-2013	4	No history because of migration.
29-May-2019	5	Removed the part numbers TS419IDT, TS421IDT and all its reference throughout the document.

Contents

1	Maximum ratings	2
2	Typical application schematics	4
3	Electrical characteristics	5
4	Electrical characteristics curves	9
5	Application information	34
5.1	BTL configuration principle	34
5.2	Gain in typical application schematic	34
5.3	Low and high frequency response	34
5.4	Power dissipation and efficiency	34
5.5	Decoupling of the circuit	35
5.6	Wake-up time: T_{WU}	35
5.7	Pop performance	36
5.8	Application : Differential inputs BTL power amplifier	36
6	Package information	38
6.1	MiniSO-8 mechanical data	39
6.2	DFN8 (3x3) mechanical data	39
7	Ordering information	41
	Revision history	42

List of tables

Table 1.	Absolute maximum ratings	2
Table 2.	Operating conditions	2
Table 3.	Application components information	4
Table 4.	Electrical characteristics $V_{CC} = +5\text{ V}$, $GND = 0\text{ V}$, $T_{amb} = 25\text{ }^{\circ}\text{C}$ (unless otherwise specified)	5
Table 5.	Electrical characteristics $V_{CC} = +3.3\text{ V}$, $GND = 0\text{ V}$, $T_{amb} = 25\text{ }^{\circ}\text{C}$ (unless otherwise specified)	6
Table 6.	Electrical characteristics $V_{CC} = +2.5\text{ V}$, $GND = 0\text{ V}$, $T_{amb} = 25\text{ }^{\circ}\text{C}$ (unless otherwise specified)	7
Table 7.	Electrical characteristics $V_{CC} = +2\text{ V}$, $GND = 0\text{ V}$, $T_{amb} = 25\text{ }^{\circ}\text{C}$ (unless otherwise specified)	8
Table 8.	Components	37
Table 9.	MiniSO-8 mechanical data	39
Table 10.	DFN8 (3x3) mechanical data	40
Table 11.	Order codes	41
Table 12.	Document revision history	42

List of figures

Figure 1.	Application schematics	4
Figure 2.	Open loop gain and phase vs. frequency	9
Figure 3.	Open loop gain and phase vs. frequency $V_{CC} = 2\text{ V}$	9
Figure 4.	Open loop gain and phase vs. frequency $V_{CC} = 5\text{ V}$	9
Figure 5.	Open loop gain and phase vs. frequency $Z_L = 8\ \Omega$	9
Figure 6.	Open loop gain and phase vs. frequency $R_L = 16\ \Omega$	10
Figure 7.	Open loop gain and phase vs. frequency $R_L = 16\ \Omega$, $V_{CC} = 2\text{ V}$	10
Figure 8.	Open loop gain and phase vs. frequency $Z_L = 16\ \Omega$, $V_{CC} = 5\text{ V}$	10
Figure 9.	Open loop gain and phase vs. frequency $Z_L = 16\ \Omega$, $V_{CC} = 2\text{ V}$	10
Figure 10.	Open loop gain and phase vs. frequency $R_L = 32\ \Omega$	11
Figure 11.	Open loop gain and phase vs. frequency $R_L = 32\ \Omega$, $V_{CC} = 2\text{ V}$	11
Figure 12.	Open loop gain and phase vs. frequency $Z_L = 32\ \Omega$	11
Figure 13.	Open loop gain and phase vs. frequency $Z_L = 32\ \Omega$, $V_{CC} = 2\text{ V}$	11
Figure 14.	Current consumption vs. power supply voltage	12
Figure 15.	Current consumption vs. standby voltage $V_{CC} = 5\text{ V}$	12
Figure 16.	Current consumption vs. standby voltage $V_{CC} = 3.3\text{ V}$	12
Figure 17.	Current consumption vs. standby voltage $V_{CC} = 2\text{ V}$	12
Figure 18.	Current consumption vs. standby voltage $V_{CC} = 5\text{ V}$ (TS421)	13
Figure 19.	Current consumption vs. standby voltage $V_{CC} = 3.3\text{ V}$ (TS421)	13
Figure 20.	Current consumption vs. standby voltage $V_{CC} = 2\text{ V}$ (TS421)	13
Figure 21.	Output power vs. power supply voltage $R_L = 8\ \Omega$	13
Figure 22.	Output power vs. power supply voltage $R_L = 16\ \Omega$	14
Figure 23.	Output power vs. power supply voltage $R_L = 32\ \Omega$	14
Figure 24.	Output power vs. power supply voltage $R_L = 64\ \Omega$	14
Figure 25.	Output power vs. load resistor $V_{CC} = 5\text{ V}$	14
Figure 26.	Output power vs. load resistor $V_{CC} = 3.3\text{ V}$	15
Figure 27.	Output power vs. load resistor $V_{CC} = 2.5\text{ V}$	15
Figure 28.	Output power vs. load resistor $V_{CC} = 2\text{ V}$	15
Figure 29.	Power dissipation vs. output power $V_{CC} = 5\text{ V}$	15
Figure 30.	Power dissipation vs. output power $V_{CC} = 3.3\text{ V}$	16
Figure 31.	Power dissipation vs. output power $V_{CC} = 2.5\text{ V}$	16
Figure 32.	Power dissipation vs. output power $V_{CC} = 2\text{ V}$	16
Figure 33.	Power derating curves	16
Figure 34.	Output voltage swing for one Amp. vs. power supply voltage	17
Figure 35.	THD + N vs. output power $R_L = 8\ \Omega$	17
Figure 36.	THD + N vs. output power $R_L = 16\ \Omega$	17
Figure 37.	THD + N vs. output power $R_L = 32\ \Omega$	18
Figure 38.	THD + N vs. output power $R_L = 8\ \Omega$, $A_v = 2$	18
Figure 39.	THD + N vs. output power $R_L = 16\ \Omega$, $A_v = 2$	18
Figure 40.	THD + N vs. output power $R_L = 32\ \Omega$, $A_v = 2$	18
Figure 41.	THD + N vs. output power $R_L = 8\ \Omega$, $C_b = 1\ \mu\text{F}$	19
Figure 42.	THD + N vs. output power $R_L = 16\ \Omega$, $C_b = 1\ \mu\text{F}$	19
Figure 43.	THD + N vs. output power $R_L = 32\ \Omega$, $C_b = 1\ \mu\text{F}$	19
Figure 44.	THD + N vs. frequency $R_L = 8\ \Omega$	19
Figure 45.	THD + N vs. frequency $R_L = 16\ \Omega$	20
Figure 46.	THD + N vs. frequency $R_L = 32\ \Omega$	20
Figure 47.	Signal to noise ratio vs. power supply voltage with unweighted filter (20 Hz to 20 kHz)	20
Figure 48.	Signal to noise ratio vs. power supply voltage with weighted filter Type A	20
Figure 49.	Noise floor $V_{CC} = 5\text{ V}$	21
Figure 50.	Noise floor $V_{CC} = 2\text{ V}$	21
Figure 51.	PSRR vs. input capacitor	21
Figure 52.	PSRR vs. power supply voltage	21

Figure 53.	PSRR vs. bypass capacitor $C_b = C_{in} = 1 \mu\text{F}$	22
Figure 54.	PSRR vs. bypass capacitor $C_b = 4.7 \mu\text{F}$	22
Figure 55.	PSRR vs. bypass capacitor $C_b = 10 \mu\text{F}$	22
Figure 56.	THD + N vs. output power $R_L = 8 \Omega$	22
Figure 57.	THD + N vs. output power $R_L = 16 \Omega$	23
Figure 58.	THD + N vs. output power $R_L = 32 \Omega$	23
Figure 59.	THD + N vs. output power $R_L = 8 \Omega, A_v = 4$	23
Figure 60.	THD + N vs. output power $R_L = 16 \Omega, A_v = 4$	23
Figure 61.	THD + N vs. output power $R_L = 32 \Omega, A_v = 4$	24
Figure 62.	THD + N vs. output power $R_L = 8 \Omega$	24
Figure 63.	THD + N vs. output power $R_L = 16 \Omega$	24
Figure 64.	THD + N vs. output power $R_L = 32 \Omega$	24
Figure 65.	THD + N vs. frequency $R_L = 8 \Omega$	25
Figure 66.	THD + N vs. frequency $R_L = 16 \Omega$	25
Figure 67.	THD + N vs. frequency $R_L = 32 \Omega$	25
Figure 68.	Signal-to-noise ratio vs. power supply voltage with unweighted filter (20 Hz to 20 kHz)	25
Figure 69.	Signal-to-noise ratio vs power supply voltage with weighted filter Type A	26
Figure 70.	Noise floor $V_{cc} = 5 \text{ V}$	26
Figure 71.	Noise floor $V_{cc} = 2 \text{ V}$	26
Figure 72.	PSRR vs. power supply voltage	26
Figure 73.	PSRR vs. input capacitor	27
Figure 74.	PSRR vs. bypass capacitor $C_b = C_{in} = 1 \mu\text{F}$	27
Figure 75.	PSRR vs. bypass capacitor $C_b = C_{in} = 4.7 \mu\text{F}$	27
Figure 76.	PSRR vs. bypass capacitor $C_b = C_{in} = 10 \mu\text{F}$	27
Figure 77.	THD + N vs. output power $R_L = 8 \Omega$	28
Figure 78.	THD + N vs. output power $R_L = 16 \Omega$	28
Figure 79.	THD + N vs. output power $R_L = 32 \Omega$	28
Figure 80.	THD + N vs. output power $R_L = 8 \Omega, A_v = 8$	28
Figure 81.	THD + N vs. output power $R_L = 16 \Omega, A_v = 8$	29
Figure 82.	THD + N vs. output power $R_L = 32 \Omega, A_v = 8$	29
Figure 83.	THD + N vs. output power $R_L = 8 \Omega, C_b = 1 \mu\text{F}$	29
Figure 84.	THD + N vs. output power $R_L = 16 \Omega, C_b = 1 \mu\text{F}$	29
Figure 85.	THD + N vs. output power $R_L = 32 \Omega, C_b = 1 \mu\text{F}$	30
Figure 86.	THD + N vs. frequency $R_L = 8 \Omega$	30
Figure 87.	THD + N vs. frequency $R_L = 16 \Omega$	30
Figure 88.	THD + N vs. frequency $R_L = 32 \Omega$	30
Figure 89.	Signal to noise ratio vs. power supply voltage with unweighted filter (20 Hz to 20 kHz)	31
Figure 90.	Signal to noise ratio vs. power supply voltage with weighted filter Type A	31
Figure 91.	Noise floor $V_{cc} = 5 \text{ V}$	31
Figure 92.	Noise floor $V_{cc} = 2 \text{ V}$	31
Figure 93.	PSRR vs. power supply voltage	32
Figure 94.	PSRR vs. input capacitor	32
Figure 95.	PSRR vs. bypass capacitor $C_b = C_{in} = 1 \mu\text{F}$	32
Figure 96.	PSRR vs. bypass capacitor $C_b = 4.7 \mu\text{F}$	32
Figure 97.	PSRR vs. bypass capacitor $C_b = 1 \mu\text{F}$	33
Figure 98.	Differential input amplifier configuration	36
Figure 99.	MiniSO-8 drawing	39
Figure 100.	DFN8 (3x3) drawing	40

IMPORTANT NOTICE – PLEASE READ CAREFULLY

STMicroelectronics NV and its subsidiaries (“ST”) reserve the right to make changes, corrections, enhancements, modifications, and improvements to ST products and/or to this document at any time without notice. Purchasers should obtain the latest relevant information on ST products before placing orders. ST products are sold pursuant to ST’s terms and conditions of sale in place at the time of order acknowledgement.

Purchasers are solely responsible for the choice, selection, and use of ST products and ST assumes no liability for application assistance or the design of Purchasers’ products.

No license, express or implied, to any intellectual property right is granted by ST herein.

Resale of ST products with provisions different from the information set forth herein shall void any warranty granted by ST for such product.

ST and the ST logo are trademarks of ST. For additional information about ST trademarks, please refer to www.st.com/trademarks. All other product or service names are the property of their respective owners.

Information in this document supersedes and replaces information previously supplied in any prior versions of this document.

© 2019 STMicroelectronics – All rights reserved

Компания «Life Electronics» занимается поставками электронных компонентов импортного и отечественного производства от производителей и со складов крупных дистрибьюторов Европы, Америки и Азии.

С конца 2013 года компания активно расширяет линейку поставок компонентов по направлению коаксиальный кабель, кварцевые генераторы и конденсаторы (керамические, пленочные, электролитические), за счёт заключения дистрибьюторских договоров

Мы предлагаем:

- Конкурентоспособные цены и скидки постоянным клиентам.
- Специальные условия для постоянных клиентов.
- Подбор аналогов.
- Поставку компонентов в любых объемах, удовлетворяющих вашим потребностям.
- Приемлемые сроки поставки, возможна ускоренная поставка.
- Доставку товара в любую точку России и стран СНГ.
- Комплексную поставку.
- Работу по проектам и поставку образцов.
- Формирование склада под заказчика.
- Сертификаты соответствия на поставляемую продукцию (по желанию клиента).
- Тестирование поставляемой продукции.
- Поставку компонентов, требующих военную и космическую приемку.
- Входной контроль качества.
- Наличие сертификата ISO.

В составе нашей компании организован Конструкторский отдел, призванный помогать разработчикам, и инженерам.

Конструкторский отдел помогает осуществить:

- Регистрацию проекта у производителя компонентов.
- Техническую поддержку проекта.
- Защиту от снятия компонента с производства.
- Оценку стоимости проекта по компонентам.
- Изготовление тестовой платы монтаж и пусконаладочные работы.



Тел: +7 (812) 336 43 04 (многоканальный)
Email: org@lifeelectronics.ru