

EAO – Your Expert Partner for
Human Machine Interfaces

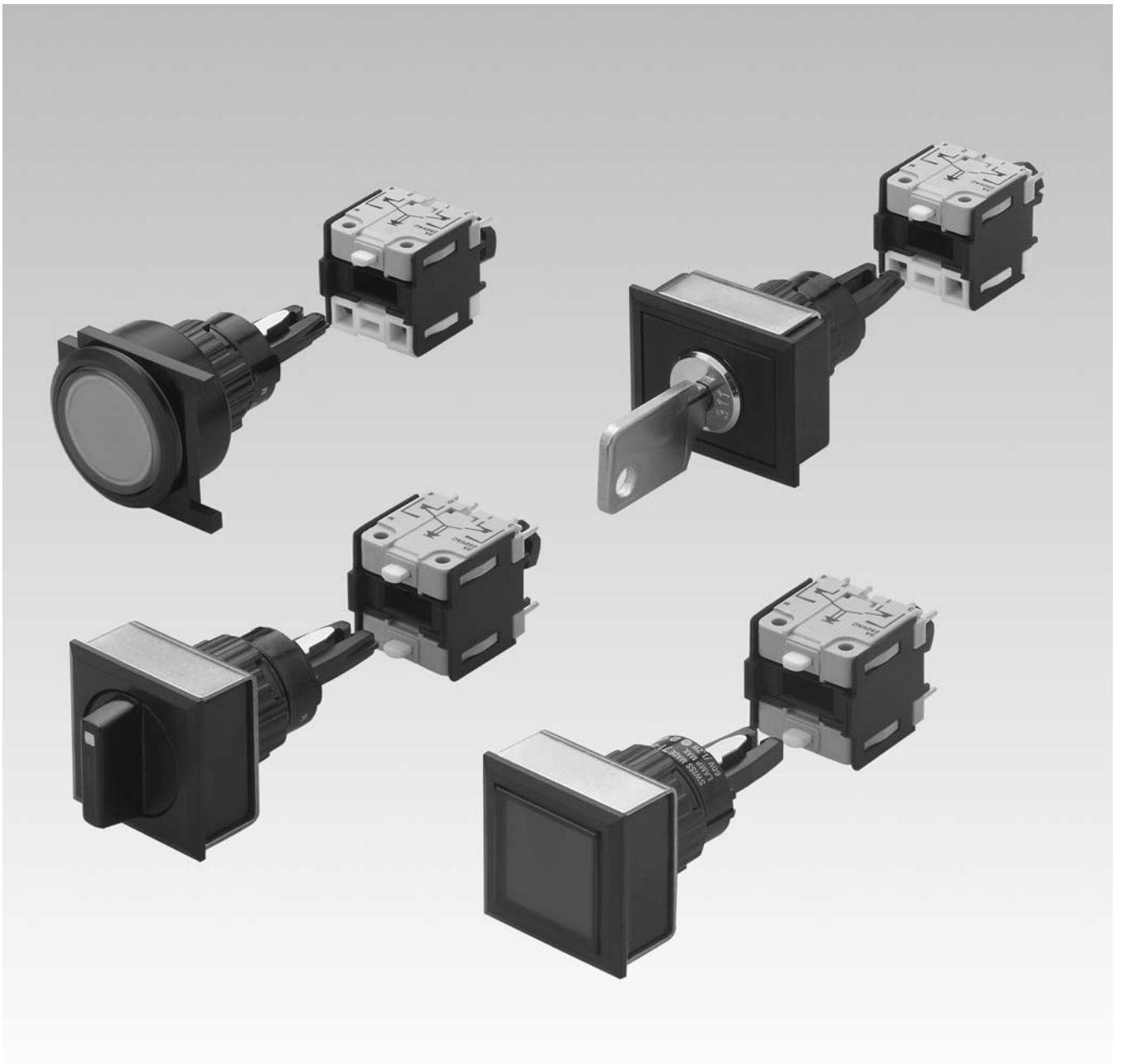

EAO Product Information

Series 71



Description	3
Product Assembly	4
Devices flush mounting	8
Accessories.....	12
Technical Data.....	21
Application guidelines.....	22
Drawings.....	23
Index.....	29

Product Information

General notes

The system switch 71 is a pushbutton system of modular design, which is especially suited for the assembly of input units. It consists of a lens, front module, actuator and switching element. It has five decisive advantages:

1. Attractive front design

Various attractively designed low profile actuators guarantee ergonomic and user-friendly operation.

2. A multitude of combinations

Due to a clever modular assembly system - based on PCB technology - with a standard print layout, this system component tops also anything in flexibility.

3. Compact operation unit

The extremely small dimensions of the switching elements and the use of PCB's give a broad scope of benefits where space is a premium.

4. Efficient manufacture

The print adaptable switching element can be directly soldered to the PCB without the aid of additional mechanical or electrical mounting components. This means reduced production costs, reduction of wiring errors and bad contacts.

5. A clever way of mounting

Front module and PCB module can be simple assembled and disassembled without tools due to the patented interlocking pin mechanism.

Mounting

All actuators are plugged into the mounting cut-out from the front via front module. It is then fixed into place from the back with the mounting clip and the locking nut. The max. torque on the locking nut is limited to 50 Ncm.

The switching element can be pre-mounted on the PCB and later connected to the actuator by insertion of the position legs and securing with the interlocking pin mechanism. Additional adjusting or spacers are not required.

It has to pay attention, that there will be no kind of mechanical stress on the PCB (eg. caused by tension on the wiring).

Lenses

The flat, transparent lenses are available in various colours. The round version can also be supplied in aluminium.

Anodized aluminium parts can have visible variations due production-technical reasons.

Illumination

T1 ³/₄ midget groove LED's in red, blue, green, yellow and white or filament lamps give superb illumination and can be supplied in 6, 12, 24, or 48 V.

Luminosity and wave length scattering caused by the technology used in the LED manufacturing processes may lead to visual differences in our products.

Keylock switch

Standard lock (Index D). Standard lock number is 311. If the lock number is not specified, we will supply standard number 311.

An additional 134 special locks (Index X) are available on request.

Master keys for lock numbers 311 ... 445 may be ordered by quoting Typ-Nr. 31-989.300. Two keys are supplied with each keylock switch. Spare keys (Index D) for standard locks may be ordered by quoting Typ-Nr. 31-989.xxx (please state the lock number).

Specimen order

Pushbutton :

- Illuminated pushbutton actuator, momentary action, 25 mm dia. 71-611.0

Essential accessories :

- Lens plastic green transparent, 25 mm dia. 61-9642.7
- Single-LED T1 ³/₄ MG, 24 VDC, green 10-2J12.1065
- Front bezel set for Illuminated Pushbutton, Aluminium natural, 25 mm dia. 61-9933.0
- Switching element 1 NC + 1 NO 71-671.026

*We reserve the right to modify technical data
All dimensions in mm*

Indicator, flush mounting

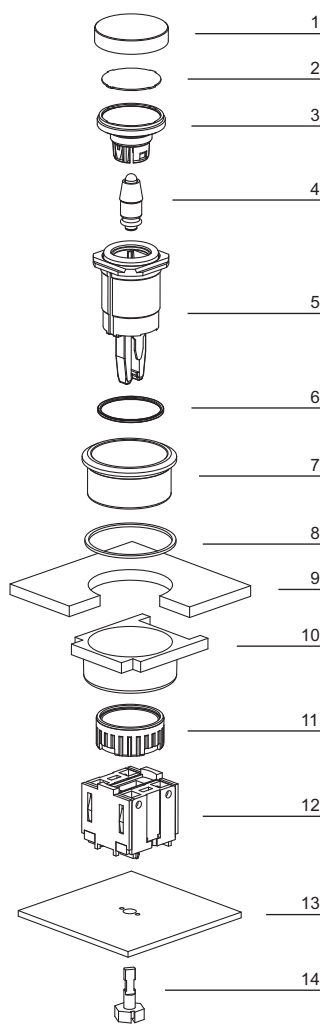

- 1 Lens
- 2 Marking plate
- 3 Lens holder
- 4 LED
- 5 Actuator housing
- 6 Sealing
- 7 Front bezel
- 8 Sealing
- 9 Front plate
- 10 Thrust piece
- 11 Fixing nut
- 12 Illumination element
- 13 Printed circuit board
- 14 Interlocking pin

Pushbutton illuminative, flush mounting

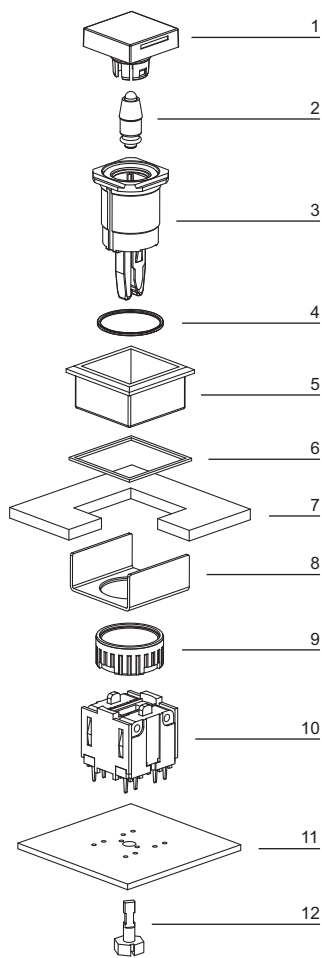

- 1 Lens
- 2 LED
- 3 Actuator housing
- 4 Sealing
- 5 Front bezel
- 6 Sealing
- 7 Front plate
- 8 Fixing bracket
- 9 Fixing nut
- 10 Switching element
- 11 Printed circuit board
- 12 Interlocking pin

Keylock switch, flush mounting

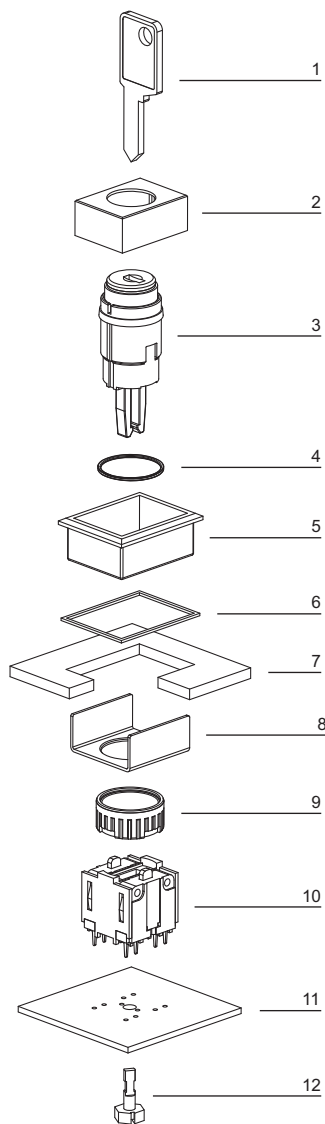

- 1 Key
- 2 Keylock front bezel
- 3 Keylock switch actuator
- 4 Sealing
- 5 Front bezel
- 6 Sealing
- 7 Front plate
- 8 Fixing bracket
- 9 Fixing nut
- 10 Switching element
- 11 Printed circuit board
- 12 Interlocking pin

Selector switch illuminative, flush mounting

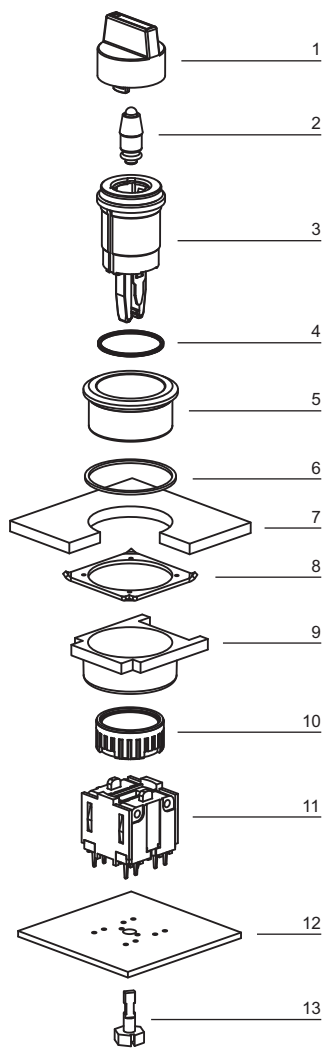





- 1 Lever
- 2 LED
- 3 Selector switch actuator
- 4 Sealing
- 5 Front bezel
- 6 Sealing
- 7 Front plate
- 8 Anti-twist ring
- 9 Thrust piece
- 10 Fixing nut
- 11 Switching element
- 12 Printed circuit board
- 13 Interlocking pin

Indicator actuator, flush mounting

Actuators usable for front dimensions: \square 24 x 24 mm | \square 24 x 30 mm | 25 mm dia.



Essential Accessories:

-  Front bezel set for Indicators and Illuminated pushbutton, flush mounting page 14
-  Illumination element page 17
-  Lens plastic, flush mounting page 12
-  Single-LED page 19

	Front protection	Typ-Nr.	Mounting dimensions	Technical drawing	Circuit drawing	
Indicator actuator, flush mounting	IP 65	71-600.0	1	6	3	0.005





Mounting dimensions from page 24, Technical drawing from page 24, Circuit drawing from page 26

Illuminated pushbutton actuator, flush mounting

Actuators usable for front dimensions: \square 24 x 24 mm | \square 24 x 30 mm | 25 mm dia.



Essential Accessories:

-  Front bezel set for Indicators and Illuminated pushbutton, flush mounting page 14
-  Lens plastic, flush mounting page 12
-  Single-LED page 19
-  Switching element for Illuminated pushbutton | Mushroom-head pushbutton page 18

	Front protection	Switching action	Typ-Nr.	Mounting dimensions	Technical drawing	Circuit drawing	
Illuminated pushbutton actuator, flush mounting	IP 65	MA	71-612.0	1	6	5	0.005
		M	71-611.0	1	6	4	0.005



Switching action: MA = Maintained action, M = Momentary action

Mounting dimensions from page 24, Technical drawing from page 24, Circuit drawing from page 26

Mushroom-head pushbutton actuator, flush mounting



Essential Accessories:

-  Front bezel set for Mushroom-head pushbutton, flush mounting page 15
-  Mushroom-head cap page 13
-  Switching element for Illuminated pushbutton | Mushroom-head pushbutton page 18

	Front protection	Switching action	Ø 32 mm Typ-Nr.	Mounting dimensions	Technical drawing	Circuit drawing	
Mushroom-head pushbutton actuator, flush mounting	IP 65	MA	71-612.0	2	5	1	0.005
		M	71-611.0	2	5	2	0.005

Switching action: MA = Maintained action, M = Momentary action



Mounting dimensions from page 24, Technical drawing from page 24, Circuit drawing from page 26

Keylock switch actuator 2 positions, flush mounting

Actuators usable for front dimensions: \square 24 x 24 mm | \square 24 x 30 mm | 25 mm dia.



Essential Accessories:

-  Front bezel set for Keylock switch, flush mounting page 15
-  Keylock front bezel for keylock switch, flush mounting page 13
-  Switching element for Keylock- and Selector switch 2 positions page 18

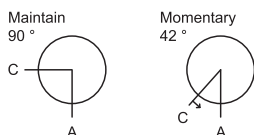

	Front protection	Switching action	Key remove	Typ-Nr.	Mounting dimensions	Technical drawing	Circuit drawing	
Keylock switch actuator 2 positions, flush mounting Position A : Basic position Standard lock 311	IP 65	MA	A	71-622.0/D	1	7	11	0.003
			C	71-623.0/D	1	7	11	0.003
			C + A	71-624.0/D	1	7	11	0.003
		M	A	71-621.0/D	1	7	10	0.003

Switching action: MA = Maintained action, M = Momentary action

Mounting dimensions from page 24, Technical drawing from page 24, Circuit drawing from page 26

Keylock switch actuator 3 positions, flush mounting

Actuators usable for front dimensions: \square 24 x 24 mm | \square 24 x 30 mm | 25 mm dia.



Essential Accessories:

- Front bezel set for Keylock switch, flush mounting page 15
- Keylock front bezel for keylock switch, flush mounting page 13
- Switching element for Keylock- and Selector switch 3 positions page 18

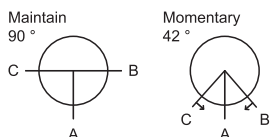

Keylock switch actuator 3 positions, flush mounting Position A : Basic position Standard lock 311	Front protection	Switching action	Key remove	Typ-Nr.	Mounting dimensions		Circuit drawing	
					Technical drawing			
	IP 65	MA-0-MA	A	71-632.0/D	1	7	13	0.003
			C	71-633.0/D	1	7	13	0.003
			C + A + B	71-635.0/D	1	7	13	0.003
			C + B	71-634.0/D	1	7	13	0.003
		MA-0-M	A	71-636.0/D	1	7	12	0.003
			C + A	71-637.0/D	1	7	12	0.003
		M-0-MA	A	71-638.0/D	1	7	9	0.003
			A + B	71-639.0/D	1	7	9	0.003
		M-0-M	A	71-631.0/D	1	7	8	0.003

Switching action: MA = Maintained action, M = Momentary action

Mounting dimensions from page 24, Technical drawing from page 24, Circuit drawing from page 26

Selector switch actuator 2 positions, flush mounting

illuminative

Actuators usable for front dimensions: \square 24 x 24 mm | 25 mm dia.



Essential Accessories:

- Front bezel set for Selector switch, flush mounting page 16
- Lever, flush mounting page 14
- Single-LED page 19
- Switching element for Keylock- and Selector switch 2 positions page 18

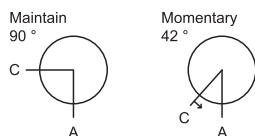

Selector switch actuator 2 positions, flush mounting Position A : Basic position	Front protection	Switching action	Typ-Nr.	Mounting dimensions		Circuit drawing	
				Technical drawing			
	IP 65	MA	71-642.0	1	8	15	0.003
		M	71-641.0	1	8	14	0.003

Switching action: MA = Maintained action, M = Momentary action

Mounting dimensions from page 24, Technical drawing from page 24, Circuit drawing from page 26

Selector switch actuator 3 positions, flush mounting

illuminative

Actuators usable for front dimensions: 24 x 24 mm | 25 mm dia.



Essential Accessories:

- Front bezel set for Selector switch, flush mounting page 16
- Lever, flush mounting page 14
- Single-LED page 19
- Switching element for Keylock- and Selector switch 3 positions page 18

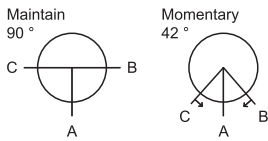

Selector switch actuator 3 positions, flush mounting Position A : Basic position	Front protection	Switching action	Typ-Nr.	Mounting dimensions		Technical drawing		Circuit drawing
	IP 65	MA-0-MA	71-652.0	1	8	19	0.003	
		MA-0-M	71-656.0	1	8	18	0.003	
		M-0-MA	71-658.0	1	8	17	0.003	
		M-0-M	71-651.0	1	8	16	0.003	

Switching action: MA = Maintained action, M = Momentary action

Mounting dimensions from page 24, Technical drawing from page 24, Circuit drawing from page 26

Front

Lens plastic, flush mounting

mat

	Lens	□ 24 x 24 mm Typ-Nr.	□ 24 x 30 mm Typ-Nr.	Ø 25 mm Typ-Nr.	
Lens plastic, flush mounting illuminative	blue transparent flush	61-9671.6	61-9681.6	61-9642.6	0.002
	colourless transparent flush	61-9671.7	61-9681.7	61-9642.7	0.002
	green transparent flush	61-9671.5	61-9681.5	61-9642.5	0.002
	orange transparent flush	61-9671.3	61-9681.3	61-9642.3	0.002
	red transparent flush	61-9671.2	61-9681.2	61-9642.2	0.002
	smoked transparent flush	61-9671.1	61-9681.1	61-9642.1	0.002
	yellow transparent flush	61-9671.4	61-9681.4	61-9642.4	0.002
non-illuminative	black opaque flush	61-9771.0	61-9781.0		0.002
	grey opaque flush	61-9771.8	61-9781.8		0.002
	white translucent flush	61-9771.9	61-9781.9		0.002



Lens plastic with symbol

	Symbol	Lens	Ø 25 mm Typ-Nr.	
Lens plastic with symbol flush - level, illuminative	ON/OFF	blue transparent	61-9643.602	0.002
		colourless transparent	61-9643.702	0.002
		green transparent	61-9643.502	0.002
		red transparent	61-9643.202	0.002
	Ring	blue transparent	61-9643.601	0.002
		colourless transparent	61-9643.701	0.002
		green transparent	61-9643.501	0.002
		orange transparent	61-9643.301	0.002
		red transparent	61-9643.201	0.002
	Stand by	blue transparent	61-9643.603	0.002
		colourless transparent	61-9643.703	0.002
		green transparent	61-9643.503	0.002
		red transparent	61-9643.203	0.002



The silvery coat is being applied on the lens (screen print) with an additional protective lacquer.

Marking plate for lens plastic

can be hot stamped

	Marking plate	Typ-Nr.	
Marking plate for lens plastic only applicable with Lens round Typ-Nr. 61-9642.X	Plastic colourless transparent	61-9707.7	0.001



Lens metal with spot

mat

	Lens	Ø 25 mm Typ-Nr.	
Lens metal with spot	Aluminium black flush	61-9841.0A	0.002
	Aluminium blue flush	61-9841.6A	0.002
	Aluminium gold flush	61-9841.4A	0.002
	Aluminium natural flush	61-9841.8A	0.002
	Aluminium olive-green flush	61-9841.5A	0.002
	Aluminium red flush	61-9841.2A	0.002



Lens metal

mat

	Lens	Ø 25 mm Typ-Nr.	
Lens metal convex	Aluminium black	61-9842.0	0.003
	Aluminium blue	61-9842.6	0.003
	Aluminium gold	61-9842.4	0.003
	Aluminium natural	61-9842.8	0.003
	Aluminium olive-green	61-9842.5	0.003
	Aluminium red	61-9842.2	0.003
flush	Aluminium black	61-9841.0	0.002
	Aluminium blue	61-9841.6	0.002
	Aluminium gold	61-9841.4	0.002
	Aluminium natural	61-9841.8	0.002
	Aluminium olive-green	61-9841.5	0.002
	Aluminium red	61-9841.2	0.002



Mushroom-head cap

	Mushroom had cap	Ø 32 mm Typ-Nr.	
Mushroom-head cap	Plastic black opaque	61-9593.0	0.004
	Plastic green opaque	61-9593.5	0.004
	Plastic red opaque	61-9593.2	0.004
	Plastic yellow opaque	61-9593.4	0.004



Keylock front bezel for keylock switch, flush mounting

	Keylock front bezel	Ø 24 x 24 mm Typ-Nr.	Ø 24 x 30 mm Typ-Nr.	Ø 25 mm Typ-Nr.	
Keylock front bezel for keylock switch, flush mounting	Plastic black	61-9220.0	61-9230.0	61-9210.0	0.001



Lever, flush mounting

	Lever	Bar colour	Typ-Nr.	$\frac{g}{kg}$
Lever, flush mounting illuminative	Plastic black	blue	61-9028.60	0.001
		green	61-9028.50	0.001
		orange	61-9028.30	0.001
		red	61-9028.20	0.001
		yellow	61-9028.40	0.001
	Plastic grey	blue	61-9029.60	0.001
		green	61-9029.50	0.001
		orange	61-9029.30	0.001
		red	61-9029.20	0.001
		yellow	61-9029.40	0.001
non-illuminative	Plastic black	black	61-9028.0	0.001
		white	61-9028.9	0.001
	Plastic grey	grey	61-9029.8	0.001
		white	61-9029.9	0.001



Front bezel set for Indicators and Illuminated pushbutton, flush mounting

	Front bezel	\varnothing 24 x 24 mm Typ-Nr.	\square 24 x 30 mm Typ-Nr.	\varnothing 25 mm Typ-Nr.	Mounting dimensions	$\frac{g}{kg}$
Front bezel set for Indicators and Illuminated pushbutton, flush mounting	Plastic black	61-9930.0	61-9931.0	61-9933.10	1	0.008
	Plastic silver	61-9930.4	61-9931.4		1	0.008
	Aluminium black			61-9933.1	1	0.006
	Aluminium blue			61-9933.6	1	0.006
	Aluminium gold			61-9933.4	1	0.006
	Aluminium natural			61-9933.0	1	0.006
	Aluminium olive-green			61-9933.5	1	0.006
	Aluminium red			61-9933.2	1	0.006



Mounting dimensions from page 24

Front bezel set for Mushroom-head pushbutton, flush mounting

	Front bezel	Ø 40 mm Typ-Nr.	Ø 25 mm Typ-Nr.	Mounting dimensions	
Front bezel set for Mushroom-head pushbutton, flush mounting	Aluminium natural	61-9934.8		2	0.013
	Aluminium black		61-9933.1	2	0.006
	Aluminium blue		61-9933.6	2	0.006
	Aluminium gold		61-9933.4	2	0.006
	Aluminium natural		61-9933.0	2	0.006
	Aluminium olive-green		61-9933.5	2	0.006
	Aluminium red		61-9933.2	2	0.006
	Plastic black		61-9933.10	2	0.008



Mounting dimensions from page 24

Front bezel set for Keylock switch, flush mounting

	Front bezel	Ø 24 x 24 mm Typ-Nr.	Ø 24 x 30 mm Typ-Nr.	Ø 25 mm Typ-Nr.	Mounting dimensions	
Front bezel set for Keylock switch, flush mounting	Plastic black	61-9930.0	61-9931.0	61-9932.10	1	0.008
	Plastic silver	61-9930.4	61-9931.4		1	0.008
	Aluminium black			61-9932.1	1	0.006
	Aluminium blue			61-9932.6	1	0.006
	Aluminium gold			61-9932.4	1	0.006
	Aluminium natural			61-9932.0	1	0.006
	Aluminium olive-green			61-9932.5	1	0.006
	Aluminium red			61-9932.2	1	0.006



With the round front bezel sets Ø25 mm the anti-twist ring is part of the sales-package.

Mounting dimensions from page 24

Front bezel set for Selector switch, flush mounting

	Front bezel	∅ 24 x 24 mm Typ-Nr.	∅ 25 mm Typ-Nr.	Mounting dimensions	
Front bezel set for Selector switch, flush mounting	Plastic black	61-9936.0		1	0.007
	Aluminium black		61-9932.1	1	0.006
	Aluminium blue		61-9932.6	1	0.006
	Aluminium gold		61-9932.4	1	0.006
	Aluminium natural		61-9932.0	1	0.006
	Aluminium olive-green		61-9932.5	1	0.006
	Aluminium red		61-9932.2	1	0.006
	Plastic black		61-9932.10	1	0.008



With the round front bezel sets ∅25 mm the anti-twist ring is part of the sales-package.
Mounting dimensions from page 24

Front protective cap

for flush - level lenses only for protection IP 68

	Front protective cap	Typ-Nr.	
Front protective cap for front bezel set 24 x 30 mm, flush mounting	Silicone natural transparent	61-9927.2	0.001
for front bezel set round, flush mounting	Silicone natural transparent	84-9103.7	0.001



ATTENTION

when using the front protection cover for push buttons the external sealing in the front bezel set and the silicone bellows in the actuator are to be removed !

Protective cover, flush mounting

	∅ 24 x 24 mm Typ-Nr.	∅ 24 x 30 mm Typ-Nr.	∅ 25 mm Typ-Nr.	Mounting dimensions	Technical drawing	
Protective cover, flush mounting hinged, transparent, with means for sealing	61-9921.0			1	1	0.006
		61-9922.0		1	2	0.006
			61-9924.0	1	3	0.006
slide by side, with means not for sealing						



Mounting dimensions from page 24, Technical drawing from page 24

Blind plug, flush mounting

	Blind plug	Ø 24 x 24 mm Typ-Nr.	Ø 24 x 30 mm Typ-Nr.	Ø 25 mm Typ-Nr.	Mounting dimensions	Technical drawing	
Blind plug, flush mounting	Plastic black	61-9451.0	61-9452.0		1		0.006
				61-9453.0	1	4	0.006



Mounting dimensions from page 24, Technical drawing from page 24

Master key

	Typ-Nr.	
Master key Lock numbers 311 ... 445 (DOM)	31-989.300	0.006



Spare key

	Typ-Nr.	
Spare key Key lock switch, standard lock 311 (DOM)	31-989.311	0.006



Other lock numbers on request

EMC Key protection cap

	Typ-Nr.	
EMC Key protection cap Plastic black, for lock type DOM	31-985.0	0.005



Backside

Illumination element

including Locking pin

	Terminals	Typ-Nr.	Component layout	Circuit drawing	
Illumination element	P	71-670.006	1	3	0.005



Terminals: P = PCB terminal

Component layout from page 23, Circuit drawing from page 26

Switching element for Illuminated pushbutton | Mushroom-head pushbutton

including Locking pin

	Terminals	Contacts	Typ-Nr.	Component layout		
				Component layout	Circuit drawing	
Switching element for Illuminated pushbutton Mushroom-head pushbutton	P	1 NC + 1 NO	71-671.026	1	7	0.005
		2 NC + 2 NO	71-672.026	1	6	0.005



Terminals: P = PCB terminal

Contacts: NC = Normally closed, NO = Normally open

Component layout from page 23, Circuit drawing from page 26

Switching element for Keylock- and Selector switch 2 positions

including Locking pin

	Terminals	Contacts	Typ-Nr.	Component layout		
				Component layout	Circuit drawing	
Switching element for Keylock- and Selector switch 2 positions	P	1 NC + 1 NO	71-671.026	1	7	0.005



Terminals: P = PCB terminal

Contacts: NC = Normally closed, NO = Normally open

Component layout from page 23, Circuit drawing from page 26

Switching element for Keylock- and Selector switch 3 positions

including Locking pin

	Contacts	Typ-Nr.	Component layout		
			Component layout	Circuit drawing	
Switching element for Keylock- and Selector switch 3 positions	2 NC + 2 NO	71-672.026	1	6	0.005



Contacts: NC = Normally closed, NO = Normally open

Component layout from page 23, Circuit drawing from page 26

Interlocking pin

	Typ-Nr.	
Interlocking pin	71-679.0	0.001



Illumination

Filament lamp

	Socket	Operating voltage/-current	Typ-Nr.	
Filament lamp	T1 3/4 MG	12 VAC/DC, 75 mA	10-1309.1309	0.001
		14 VAC/DC, 80 mA	10-1310.1319	0.001
		18 VAC/DC, 40 mA	10-1311.1249	0.001
		24 VAC/DC, 35 mA	10-1312.1229	0.001
		28 VAC/DC, 30 mA	10-1313.1209	0.001
		28 VAC/DC, 40 mA	10-1313.1249	0.001
		36 VAC/DC, 20 mA	10-1316.1179	0.001
		36 VAC/DC, 30 mA	10-1316.1209	0.001
		48 VAC/DC, 20 mA	10-1319.1179	0.001
		48 VAC/DC, 25 mA	10-1319.1199	0.001
		6 VAC/DC, 120 mA	10-1306.1349	0.001
		6.3 VAC/DC, 200 mA	10-1307.1369	0.001



Single-LED

	Socket	Light colour	Operating voltage/-current	Typ-Nr.	
Single-LED	T1 3/4 MG	blue	12 VAC/DC, 7/14 mA	10-2J09.1066	0.002
			24 VAC/DC, 7/14 mA	10-2J12.1066	0.002
			28 VAC/DC, 7/14 mA	10-2J13.1066	0.002
			48 VAC/DC, 4/8 mA	10-2J19.1046	0.002
			6 VDC, 15 mA	10-2J06.3146	0.002
		green	12 VAC/DC, 4/7 mA	10-2J09.1065	0.002
			24 VAC/DC, 4/7 mA	10-2J12.1065	0.002
			28 VAC/DC, 4/7 mA	10-2J13.1065	0.002
			48 VAC/DC, 2/4 mA	10-2J19.1045	0.002
			6 VDC, 7 mA	10-2J06.3145	0.002
		red	12 VAC/DC, 7/14 mA	10-2J09.1062	0.002
			24 VAC/DC, 7/14 mA	10-2J12.1062	0.002
			28 VAC/DC, 7/14 mA	10-2J13.1062	0.002
			48 VAC/DC, 4/8 mA	10-2J19.1042	0.002
			6 VDC, 15 mA	10-2J06.3142	0.002
		white diffuse	12 VAC/DC, 7/14 mA	10-2J09.1069	0.002
			24 VAC/DC, 7/14 mA	10-2J12.1069	0.002
			28 VAC/DC, 7/14 mA	10-2J13.1069	0.002
			48 VAC/DC, 4/8 mA	10-2J19.1049	0.002
			6 VDC, 15 mA	10-2J06.3149	0.002
		yellow	12 VAC/DC, 7/14 mA	10-2J09.1064	0.002
			24 VAC/DC, 7/14 mA	10-2J12.1064	0.002
			28 VAC/DC, 7/14 mA	10-2J13.1064	0.002
			48 VAC/DC, 4/8 mA	10-2J19.1044	0.002
			6 VDC, 15 mA	10-2J06.3144	0.002



Note:
AC operation through halve-wave rectifier possible, slight flickering can occur.

Assembling

Anti-twist ring

	Typ-Nr.	
Anti-twist ring Mounting hole size 22.5 mm dia.	61-9912.0	0.002



Lens remover

	Typ-Nr.	
Lens remover	61-9730.0	0.011



Lamp remover

	Typ-Nr.	
Lamp remover	61-9740.0	0.003



CAUTION

A switching process might be released when replacing the lamp/LED !

Mounting tool

	Typ-Nr.	
Mounting tool for Indicator 16 mm dia.	01-907	0.020



System switch 71

Switching system

Self-cleaning, double-break snap-action switching system with one NC- (Normally closed) and one NO-contact (Normally open).

Material

Lens

Polycarbonat (PC), as per UL 94 V0, or Aluminium anodized

Front bezel

Polyetherimid (PEI), as per UL 94 V0, or Aluminium anodized

Material of contact

AgNi, 2 µm gold plated

Switching element

Polyethylene terephthalate (PETP), as per UL 94 V0

Actuator housing

Polyetherimide (PEI), as per UL 94 V0

Mechanical characteristics

Terminals

PCB terminal, Brass gold plated

Actuating torque

Selector-/ Keylock switch 4 Ncm ... 8 Ncm

Actuating force

Pushbutton 2 N ... 3 N

Actuating travel

Pushbutton 3 mm

Selector-/ keylock switch	2 positions	3 positions
Momentary action	approx. 42 °	approx. 2 x 42 °
Maintained action	approx. 90 °	approx. 2 x 90 °

Rebound time

≤1 ms

Mechanical lifetime

Pushbutton maintained action	1 million	cycles of operation
Pushbutton momentary action	2 million	cycles of operation
Keylock switch	50 000	cycles of operation
Selector switch	100 000	cycles of operation

Resistance to heat of soldering

Manual soldering	350 °C, 3 sec.
Flow soldering	260 °C, 5 sec.

Electrical characteristics

Contact resistance

Starting value (initial) ≤50 mΩ

Isolation resistance

≥10¹² Ω

Switch rating

Switch rating AC cosφ 0.7 ... 0.8

Voltage	250 VAC
Current	3 A

Switch rating DC

Voltage	24 VDC	250 VDC
Current	3 A	0.5

Recommended minimum operational data

Voltage	5 VAC
Current	10 mA

Electric strength

2000 VAC, 50 Hz, 1 min. between all terminals and earth

Environmental conditions

Storage temperature

-40 °C ... +85 °C

Operating temperature

-25 °C ... +55 °C

Protection degree

Frontside IP 65

Shock resistance

(semi-sinusoidal)

max. 500 m/s², pulse width 11 ms, 3-axis, as per EN IEC 60068-2-27

Vibration resistance

(sinusoidal)

max. 100 m/s² at 10 Hz ... 500 Hz, as per EN IEC 60068-2-6

Climate resistance

Damp heat, state

56 days, +40 °C / 93 % relative humidity, as per EN IEC 60068-2-78

Approvals

Declaration of conformity

CE

Suppressor circuits

When switching inductive loads such as relays, DC motors, and DC solenoids, it is always important to absorb surges (e.g. with a diode) to protect the contacts. When these inductive loads are switched off, a counter emf can severely damage switch contacts and greatly shorten lifetime.

Fig. 1 shows an inductive load with a free-wheeling diode connected in parallel. This free-wheeling diode provides a path for the inductor current to flow when the current is interrupted by the switch. Without this free-wheeling diode, the voltage across the coil will be limited only by dielectric breakdown voltages of the circuit or parasitic elements of the coil. This voltage can be kilovolts in amplitude even when nominal circuit voltages are low (e.g. 12 VDC) see Fig. 2.

The free-wheeling diode should be chosen so that the reverse breakdown voltage is greater than the voltage driving the inductive load. The DC blocking voltage (VR) of the free-wheeling diode can be found in the datasheet of a diode. The forward current should be equal or greater than the maximum current flowing through the load.

To get an efficient protection, the free-wheeling diode must be connected as close as possible to the inductive load!

Switching with inductive load

Fig. 1

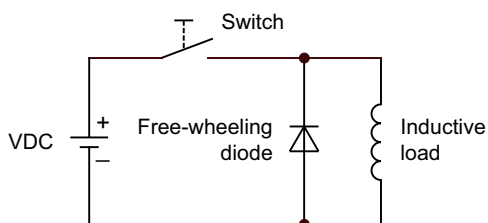

Counter emf over load without free-wheeling diode

Fig. 2

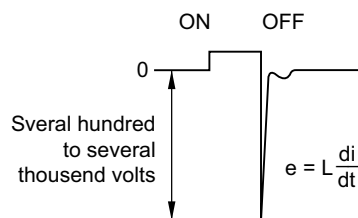

Component layout

1 Illumination element page 17 | Switching element for illuminated pushbutton | Mushroom-head pushbutton page 18 | Switching element for Keylock- and Selector switch 2 positions page 18 | Switching element for Keylock- and Selector switch 3 positions page 18

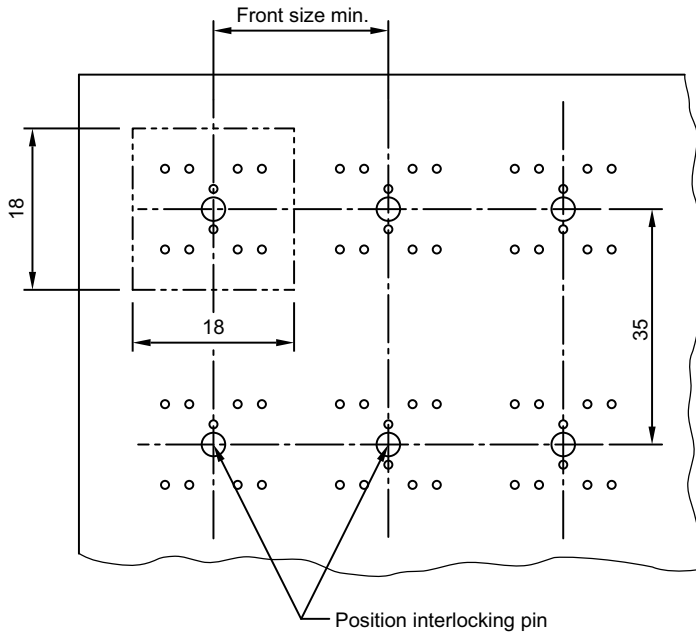

Drilling plan (Elementside)
Through-connection recommended

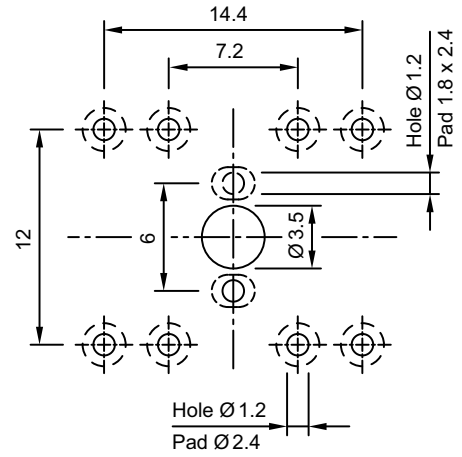

Note:

Pitch of the print circuit board hole Ø3.5 must agree with the mounting holes on the front plate

Layout

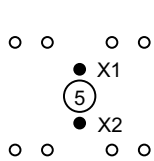

Illumination element
71-670.006

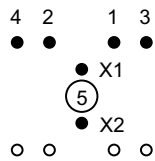

Switching element 1NC+1NO
71-671.026

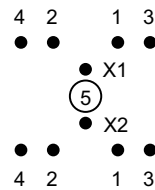

Switching element 2NC+2NO
71-672.026

- X1 Lamp cathode (-)
- X2 Lamp anode (+)
- 1-2 Contact normally closed
- 3-4 Contact normally open
- 5 Hole for interlocking pin

Mounting dimensions

1 Indicator actuator, flush mounting page 8 | Illuminated pushbutton actuator, flush mounting page 8 | Keylock switch actuator 2 positions, flush mounting page 9 | Keylock switch actuator 3 positions, flush mounting page 10 | Selector switch actuator 2 positions, flush mounting page 10 | Selector switch actuator 3 positions, flush mounting page 11 | Front bezel set for Indicators and Illuminated pushbutton, flush mounting page 14 | Front bezel set for Keylock switch, flush mounting page 15 | Front bezel set for Selector switch, flush mounting page 16 | Protective cover, flush mounting page 16 | Blind plug, flush mounting page 17

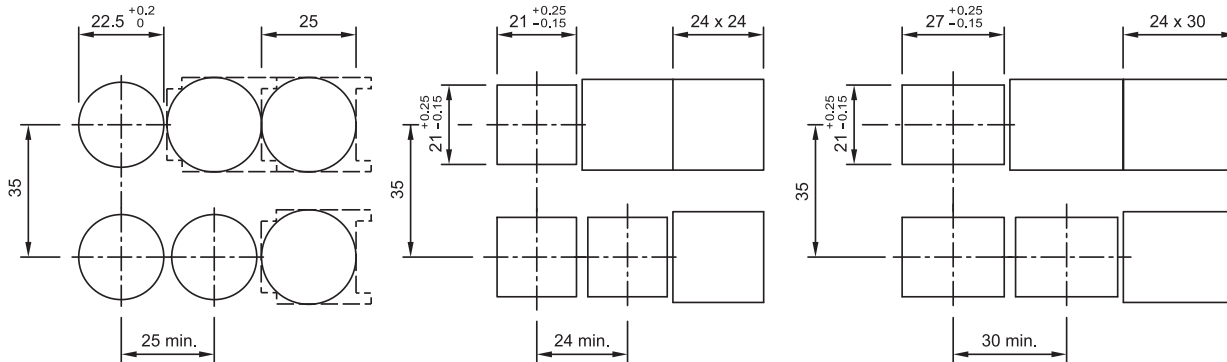

NOTE

Pitch of the front plate mounting holes must agree with the printed circuit board holes 3.5 dia.

2 Mushroom-head pushbutton actuator, flush mounting page 9 | Front bezel set for Mushroom-head pushbutton, flush mounting page 15

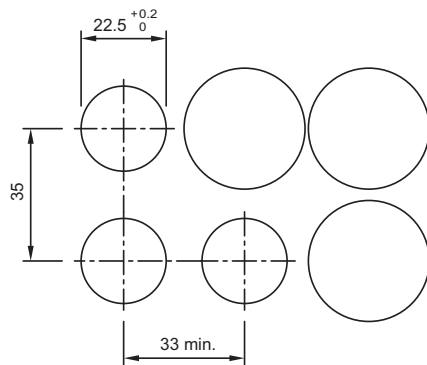

Hole spacing 41 mm min. by using front bezel set 61-9934.8

Technical drawing

1 Protective cover, flush mounting page 16

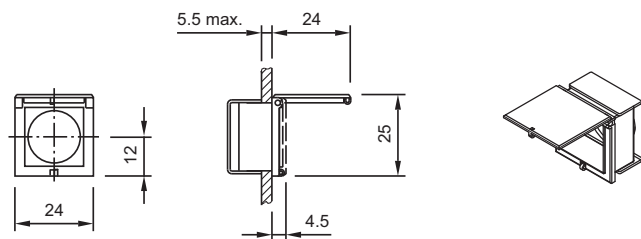

2 Protective cover, flush mounting page 16

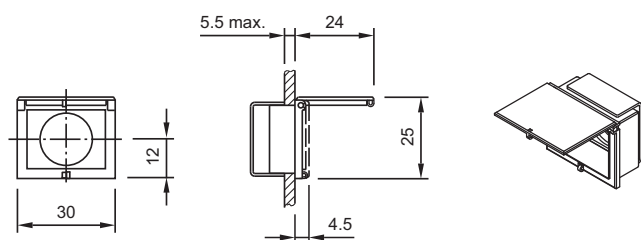

3 Protective cover, flush mounting page 16

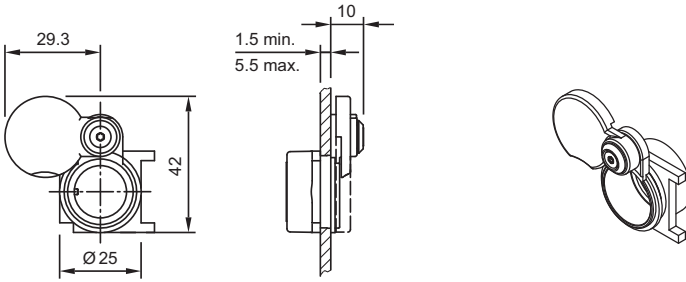

4 Blind plug, flush mounting page 17

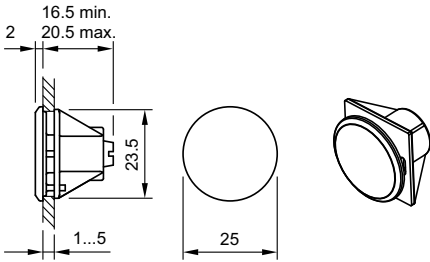

5 Mushroom-head pushbutton actuator, flush mounting page 9

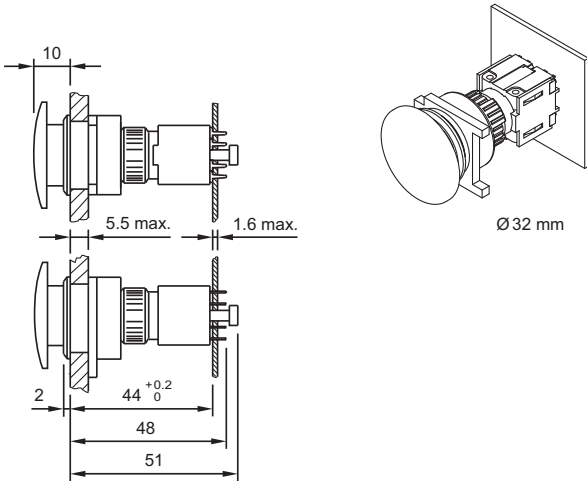

6 Indicator actuator, flush mounting page 8 | Illuminated pushbutton actuator, flush mounting page 8

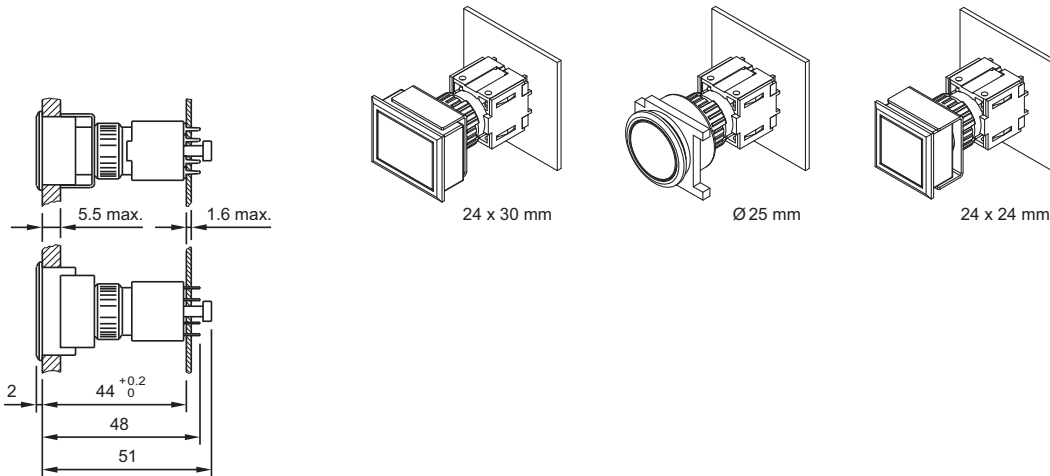

7 Keylock switch actuator 2 positions, flush mounting page 9 | Keylock switch actuator 3 positions, flush mounting page 10

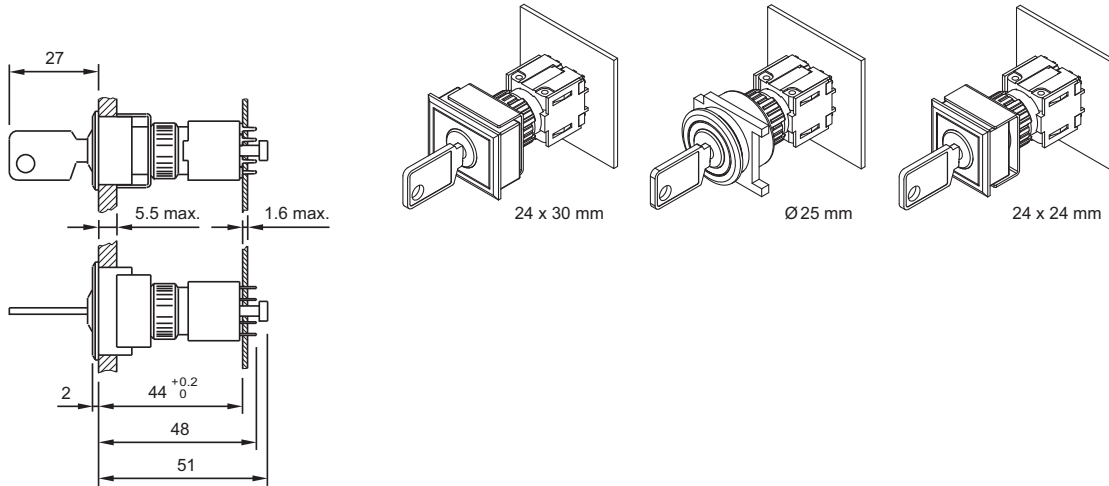

8 Selector switch actuator 2 positions, flush mounting page 10 | Selector switch actuator 3 positions, flush mounting page 11

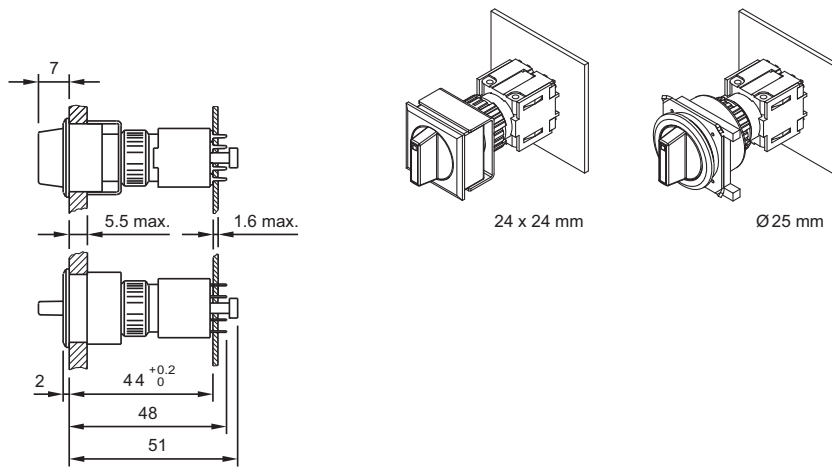

Circuit drawing

1 Mushroom-head pushbutton actuator, flush mounting page 9



2 Mushroom-head pushbutton actuator, flush mounting page 9



3 Indicator actuator, flush mounting page 8 | Illumination element page 17



4 Illuminated pushbutton actuator, flush mounting page 8

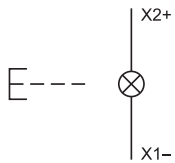

5 Illuminated pushbutton actuator, flush mounting page 8

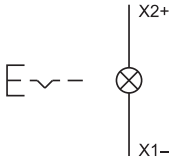

6 Switching element for Illuminated pushbutton | Mushroom-head pushbutton page 18 | **Switching element for Keylock- and Selector switch 3 positions** page 18

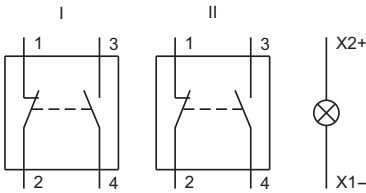

7 Switching element for Illuminated pushbutton | Mushroom-head pushbutton page 18 | **Switching element for Keylock- and Selector switch 2 positions** page 18

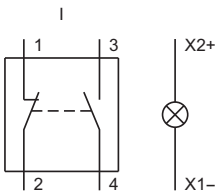

8 Keylock switch actuator 3 positions, flush mounting page 10



9 Keylock switch actuator 3 positions, flush mounting page 10



10 Keylock switch actuator 2 positions, flush mounting page 9



11 Keylock switch actuator 2 positions, flush mounting page 9



12 Keylock switch actuator 3 positions, flush mounting page 10

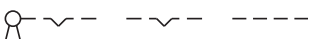

13 Keylock switch actuator 3 positions, flush mounting page 10



14 Selector switch actuator 2 positions, flush mounting page 10

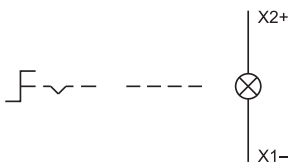

15 Selector switch actuator 2 positions, flush mounting page 10



16 Selector switch actuator 3 positions, flush mounting page 11



17 Selector switch actuator 3 positions, flush mounting page 11

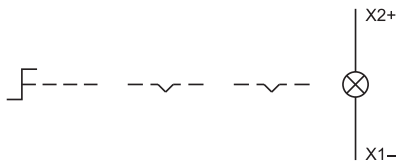

18 Selector switch actuator 3 positions, flush mounting page 11

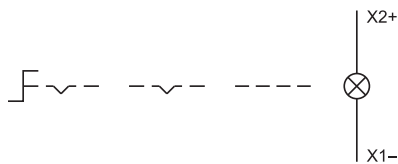

19 Selector switch actuator 3 positions, flush mounting page 11

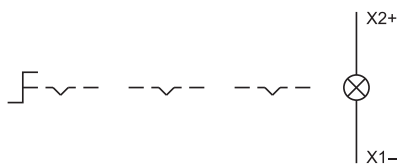

Index from Typ-Nr.

Typ-Nr.	Page	Typ-Nr.	Page	Typ-Nr.	Page
01-907	20	61-9593.4	13	61-9842.8	13
10-1306.1349	19	61-9593.5	13	61-9912.0	20
10-1307.1369	19	61-9642.1	12	61-9921.0	16
10-1309.1309	19	61-9642.2	12	61-9922.0	16
10-1310.1319	19	61-9642.3	12	61-9924.0	16
10-1311.1249	19	61-9642.4	12	61-9927.2	16
10-1312.1229	19	61-9642.5	12	61-9930.0	14
10-1313.1209	19	61-9642.6	12	61-9930.0	15
10-1313.1249	19	61-9642.7	12	61-9930.4	14
10-1316.1179	19	61-9643.201	12	61-9930.4	15
10-1316.1209	19	61-9643.202	12	61-9931.0	14
10-1319.1179	19	61-9643.203	12	61-9931.0	15
10-1319.1199	19	61-9643.301	12	61-9931.4	14
10-2J06.3142	19	61-9643.401	12	61-9931.4	15
10-2J06.3144	19	61-9643.501	12	61-9932.0	15
10-2J06.3145	19	61-9643.502	12	61-9932.0	16
10-2J06.3146	19	61-9643.503	12	61-9932.1	15
10-2J06.3149	19	61-9643.601	12	61-9932.1	16
10-2J09.1062	19	61-9643.602	12	61-9932.10	15
10-2J09.1064	19	61-9643.603	12	61-9932.10	16
10-2J09.1065	19	61-9643.701	12	61-9932.2	15
10-2J09.1066	19	61-9643.702	12	61-9932.2	16
10-2J09.1069	19	61-9643.703	12	61-9932.4	15
10-2J12.1062	19	61-9671.1	12	61-9932.4	16
10-2J12.1064	19	61-9671.2	12	61-9932.5	15
10-2J12.1065	19	61-9671.3	12	61-9932.5	16
10-2J12.1066	19	61-9671.4	12	61-9932.6	15
10-2J12.1069	19	61-9671.5	12	61-9932.6	16
10-2J13.1062	19	61-9671.6	12	61-9933.0	14
10-2J13.1064	19	61-9671.7	12	61-9933.0	15
10-2J13.1065	19	61-9681.1	12	61-9933.1	14
10-2J13.1066	19	61-9681.2	12	61-9933.1	15
10-2J13.1069	19	61-9681.3	12	61-9933.10	14
10-2J19.1042	19	61-9681.4	12	61-9933.10	15
10-2J19.1044	19	61-9681.5	12	61-9933.2	14
10-2J19.1045	19	61-9681.6	12	61-9933.2	15
10-2J19.1046	19	61-9681.7	12	61-9933.4	14
10-2J19.1049	19	61-9707.7	12	61-9933.4	15
31-985.0	17	61-9730.0	20	61-9933.5	14
31-989.300	17	61-9740.0	20	61-9933.5	15
31-989.311	17	61-9771.0	12	61-9933.6	14
61-9028.0	14	61-9771.8	12	61-9933.6	15
61-9028.20	14	61-9771.9	12	61-9934.8	15
61-9028.30	14	61-9781.0	12	61-9936.0	16
61-9028.40	14	61-9781.8	12	71-600.0	8
61-9028.50	14	61-9781.9	12	71-611.0	8
61-9028.60	14	61-9841.0	13	71-611.0	9
61-9028.9	14	61-9841.0A	13	71-612.0	8
61-9029.20	14	61-9841.2	13	71-612.0	9
61-9029.30	14	61-9841.2A	13	71-621.0/D	9
61-9029.40	14	61-9841.4	13	71-622.0/D	9
61-9029.50	14	61-9841.4A	13	71-623.0/D	9
61-9029.60	14	61-9841.5	13	71-624.0/D	9
61-9029.8	14	61-9841.5A	13	71-631.0/D	10
61-9029.9	14	61-9841.6	13	71-632.0/D	10
61-9210.0	13	61-9841.6A	13	71-633.0/D	10
61-9220.0	13	61-9841.8	13	71-634.0/D	10
61-9230.0	13	61-9841.8A	13	71-635.0/D	10
61-9451.0	17	61-9842.0	13	71-636.0/D	10
61-9452.0	17	61-9842.2	13	71-637.0/D	10
61-9453.0	17	61-9842.4	13	71-638.0/D	10
61-9593.0	13	61-9842.5	13	71-639.0/D	10
61-9593.2	13	61-9842.6	13	71-641.0	10

Index from Typ-Nr.

<u>Typ-Nr.</u>	<u>Page</u>	<u>Typ-Nr.</u>	<u>Page</u>	<u>Typ-Nr.</u>	<u>Page</u>
71-642.0	10				
71-651.0	11				
71-652.0	11				
71-656.0	11				
71-658.0	11				
71-670.006	17				
71-671.026	18				
71-671.026	18				
71-672.026	18				
71-672.026	18				
71-679.0	18				
84-9103.7	16				

	EAO AG
	Tannwaldstrasse 88 4601 Olten, Switzerland
E-mail	info@eao.com
Website	www.eao.com
	Austria
Phone	+49 201 85 87 0
Fax	+49 201 85 87 210
E-mail	sales.ede@eao.com
	Belgium
Phone	+32 3 777 82 36
Fax	+32 3 777 84 19
E-mail	sales.ebl@eao.com
	China
Phone	+852 27 86 91 41
Fax	+852 27 86 95 61
E-mail	sales.ehk@eao.com
	France
Phone	+33 1 64 43 37 37
Fax	+33 1 64 43 37 49
E-mail	sales.esa@eao.com
	Germany
Phone	+49 201 85 87 0
Fax	+49 201 85 87 210
E-mail	sales.ede@eao.com
	Italy
Phone	+39 035 481 0189
Fax	+39 035 481 3786
E-mail	sales.eit@eao.com
	Japan
Phone	+81 3 5444 5411
Fax	+81 3 5444 0345
E-mail	sales.esj@eao.com
	Netherlands
Phone	+31 78 653 17 00
Fax	+31 78 653 17 99
E-mail	sales.enl@eao.com
	Sweden
Phone	+46 8 683 86 60
Fax	+46 8 724 29 12
E-mail	sales.esw@eao.com
	Switzerland
Phone	+41 62 388 95 00
Fax	+41 62 388 95 55
E-mail	sales.ech@eao.com
	United Kingdom
Phone	+44 1444 236 000
Fax	+44 1444 236 641
E-mail	sales.euk@eao.com
	USA
Phone	+1 203 877 4577
Fax	+1 203 877 3694
E-mail	sales.eus@eao.com
	Other Countries
Phone	+41 62 286 92 10
Fax	+41 62 296 21 62
E-mail	info@eao.com

Компания «Life Electronics» занимается поставками электронных компонентов импортного и отечественного производства от производителей и со складов крупных дистрибьюторов Европы, Америки и Азии.

С конца 2013 года компания активно расширяет линейку поставок компонентов по направлению коаксиальный кабель, кварцевые генераторы и конденсаторы (керамические, пленочные, электролитические), за счёт заключения дистрибьюторских договоров

Мы предлагаем:

- Конкурентоспособные цены и скидки постоянным клиентам.
- Специальные условия для постоянных клиентов.
- Подбор аналогов.
- Поставку компонентов в любых объемах, удовлетворяющих вашим потребностям.
- Приемлемые сроки поставки, возможна ускоренная поставка.
- Доставку товара в любую точку России и стран СНГ.
- Комплексную поставку.
- Работу по проектам и поставку образцов.
- Формирование склада под заказчика.
- Сертификаты соответствия на поставляемую продукцию (по желанию клиента).
- Тестирование поставляемой продукции.
- Поставку компонентов, требующих военную и космическую приемку.
- Входной контроль качества.
- Наличие сертификата ISO.

В составе нашей компании организован Конструкторский отдел, призванный помогать разработчикам, и инженерам.

Конструкторский отдел помогает осуществить:

- Регистрацию проекта у производителя компонентов.
- Техническую поддержку проекта.
- Защиту от снятия компонента с производства.
- Оценку стоимости проекта по компонентам.
- Изготовление тестовой платы монтаж и пусконаладочные работы.



Тел: +7 (812) 336 43 04 (многоканальный)

Email: org@lifeelectronics.ru