

24-RGB MATRIX LED DRIVER

DESCRIPTION

The IS31FL3746A is a general purpose 18×n (n=1~4) LED Matrix programmed via 1MHz I2C compatible interface. Each LED can be dimmed individually with 8-bit PWM data and 8-bit DC scaling (Color Calibration) data which allowing 256 steps of linear PWM dimming and 256 steps of DC current adjustable level.

Additionally each LED open and short state can be detected, IS31FL3746A store the open or short information in Open-Short Registers. The Open-Short Registers allowing MCU to read out via I2C compatible interface. Inform MCU whether there are LEDs open or short and the locations of open or short LEDs.

FEATURES

- Supply voltage range: 2.7V to 5.5V
- 18 current sinks
- Support 18×n (n=1~4) LED matrix configurations
- Individual 256 PWM control steps
- Individual 256 DC current steps
- Global 256 current steps
- SDB rising edge reset I2C module
- 29kHz PWM frequency
- 1MHz I2C-compatible interface
- State lookup registers
- Individual open and short error detect function
- De-Ghost
- QFN-32 (4mm×4mm) package

QUICK START

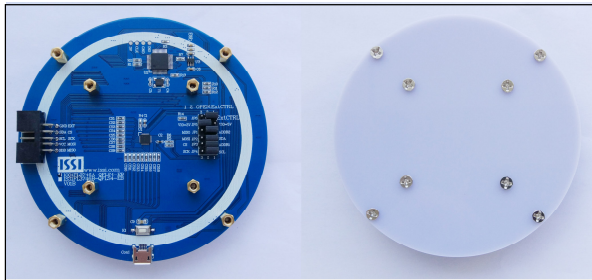

Figure 1: Photo of IS31FL3746A Evaluation Board

RECOMMENDED EQUIPMENT

- 5.0V, 2A power supply

ABSOLUTE MAXIMUM RATINGS

- ≤ 5.5V power supply

Caution: Do not exceed the conditions listed above, otherwise the board will be damaged.

PROCEDURE

The IS31FL3746A evaluation board is fully assembled and tested. Follow the steps listed below to verify board operation.

Caution: Do not turn on the power supply until all connections are completed.

- 1) Connect Pin1 and Pin2 in JP6 to enable the control of board MCU (default status).
- 2) Connect Pin2 and Pin3 in JP5 to connect the VIO to 3V.
- 3) Connect Pin1 and Pin2 in JP1 (ADDR2) / JP2 (SDA) / JP3 (ADDR1) / JP4 (SCL).
- 4) Connect the 5VDC power to VCC/GND of TP4, or plug in the USB power input to micro-USB.
- 5) Turn on the power supply, pay attention to the supply current. If the current exceeds 1A, please check for circuit fault.

EVALUATION BOARD OPERATION

The IS31FL3746A evaluation board has three display modes. Press K1 to switch configurations:

- 1) (Default mode) Colors breathe change.
- 2) Rainbow.
- 3) Half cycle colors change.

Note: IS31FL3746A solely controls the FxLED function on the evaluation board.

ORDERING INFORMATION

Part No.	Temperature Range	Package
IS31FL3746A-QFLS4-EB	-40°C to +125°C, Industrial	QFN-32, Lead-free

Table 1: Ordering Information

For pricing, delivery, and ordering information, please contacts ISSI's analog marketing team at analog@issi.com or (408) 969-6600.

SOFTWARE SUPPORT

Pin1 and Pin2 of JP6 is default shorted. If the jumper is opened or move to Pin 2 and Pin 3, the on-board MCU will configure I2C pins and SDB pin to high impedance. External I2C and SDB signals can be connected to TP4 (Above ISSI Logo) to control the IS31FL3746A LED driver.

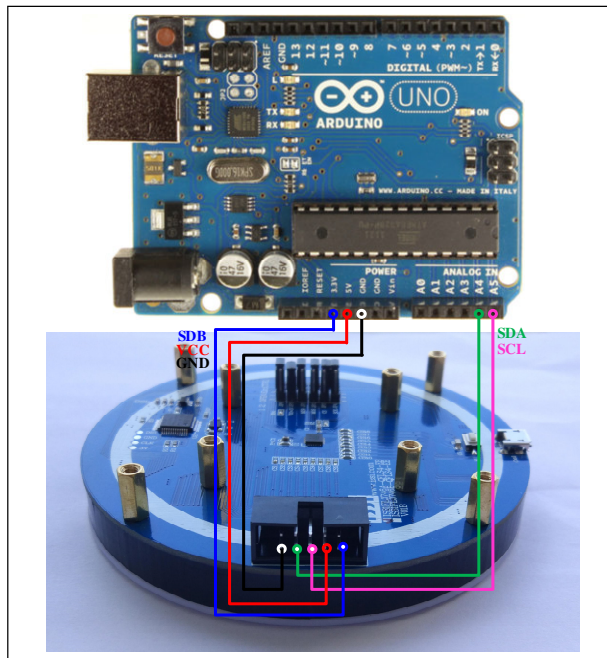

Figure 2: Photo of Arduino UNO connected to Evaluation Board

The steps listed below are an example using the Arduino for external control.

The Arduino hardware consists of an Atmel microcontroller with a bootloader allowing quick firmware updates. First download the latest Arduino Integrated Development Environment IDE (1.6.12 or greater) from www.arduino.cc/en/Main/Software. Also download the Wire.h library from www.arduino.cc/en/reference/wire and verify that pgmspace.h is in the directory ...program Files(x86)/Arduino/hardware/tools/avr/avr/include/avr/. Then download the latest IS31FL3746A test firmware (sketch) from the ISSI website <http://ams.issi.com/US/product-analog-fxled-driver.shtml>.

- 1) Open JP6's jumper or move to Pin 2 and Pin 3 (Pin 3 is floated).
- 2) Connect the 5 pins from Arduino board to TP4 (Above ISSI Logo):
 - a) Arduino GND to IS31FL3746A EVB GND.
 - b) Arduino 3.3V pin to IS31FL3746A EVB SDB.
 - c) Arduino SDA (A4) to IS31FL3746A EVB SCL.
 - d) Arduino SCL (A5) to IS31FL3746A EVB SDA.
 - e) If Arduino use 3.3V MCU VCC, connect 3.3V to IS31FL3746A EVB SDB, if Arduino use 5.0V MCU VCC, connect 5.0V to EVB SDB.
(Arduino UNO VCC is 5.0V, so SDB=5.0V)
 - f) Arduino 5V pin to IS31FL3746A EVB VCC.
- 3) Use the test code in appendix I or download the test firmware (sketch) from the ISSI website, a .txt file and copy the code to Arduino IDE, compile and upload to Arduino.
- 4) Run the Arduino code and the initial mode will change the RGB LED colors.

Please refer to the datasheet to get more information about IS31FL3746A.

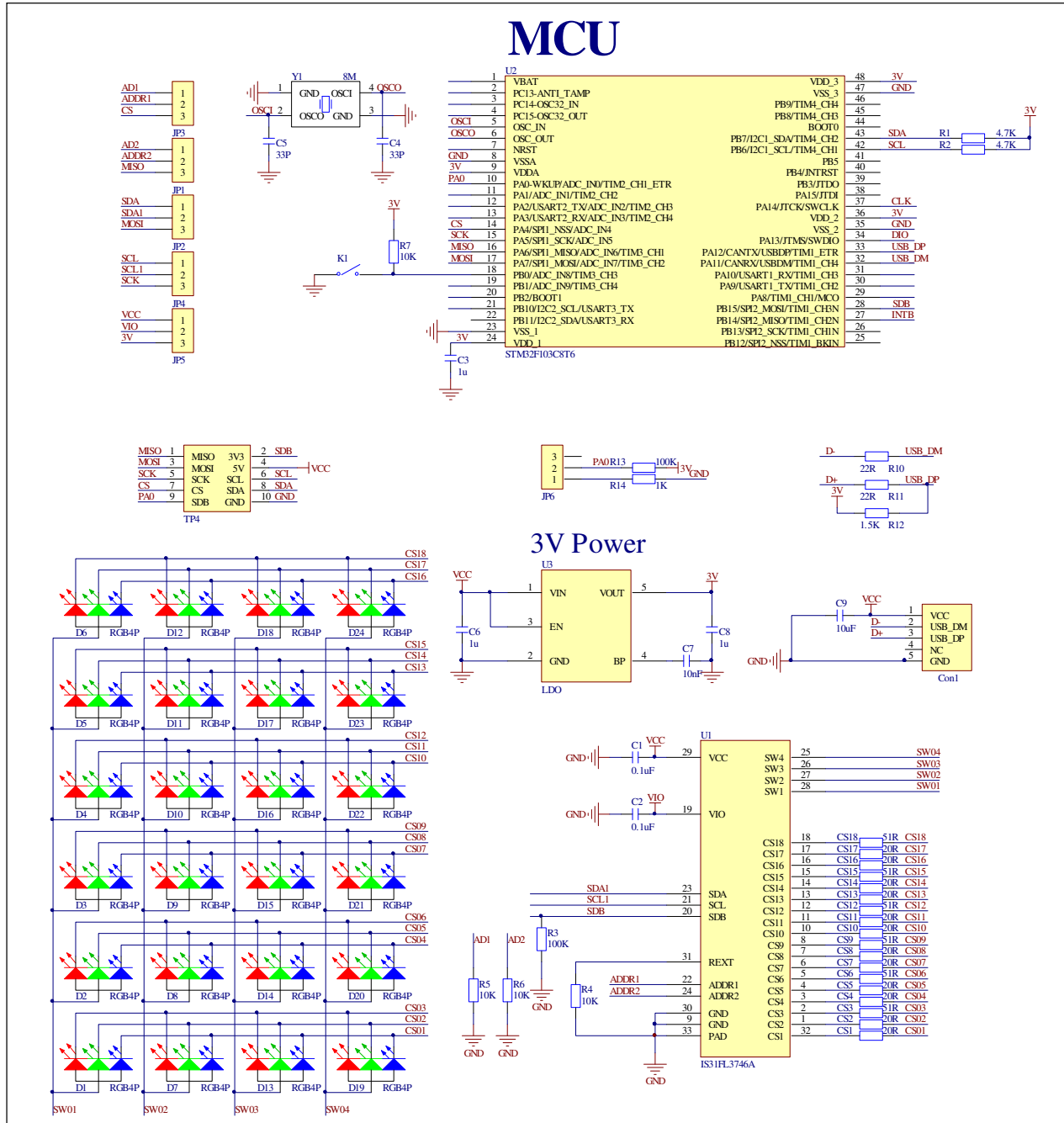

Figure 3: IS31FL3746A Application Schematic

BILL OF MATERIALS

Name	Symbol	Description	Qty	Supplier	Part No.
LED Driver	U1	Matrix LED Driver	1	ISSI	IS31FL3746A
MCU	U2	Microcontroller	1	STM	STM32F103C8T6
LDO	U3	Reduced voltage	1	SGMICRO	SGM2019-3.3V
Diode	D1~D24	RGB LED, SMD	24	Everlight	9-237/R6GHBHC-A01/2T
Crystal	Y1	Crystal, 8MHz	1	JB	HC-49S
Resistor	R1,R2	RES,4.7k,1/10W,±5%,SMD	2	Yageo	RC0603JR-074K7L
Resistor	R3,R13	RES,100k,1/10W,±5%,SMD	2	Yageo	RC0603JR-07100KL
Resistor	R4,R5,R6,R7	RES,10k,1/10W,±5%,SMD	4	Yageo	RC0603JR-0710KL
Resistor	R10,R11	RES,22R,1/10W,±5%,SMD	2	Yageo	RC0603JR-0722RL
Resistor	R12	RES,1.5k,1/10W,±5%,SMD	1	Yageo	RC0603JR-071K5L
Resistor	R14	RES,1k,1/10W,±5%,SMD	1	Yageo	RC0603JR-071KL
Resistor	CS1,CS2,CS4, CS5,CS7,CS8, CS10,CS11,CS13, CS14,CS16,CS17	RES,20R,1/10W,±5%,SMD	12	Yageo	RC0603JR-0720RL
Resistor	CS3,CS6,CS9, CS12,CS15,CS18	RES,20R,1/10W,±5%,SMD (Note 1)	6	Yageo	RC0603JR-0720RL
Capacitor	C1,C2	CAP,100nF,16V,±20%,SMD	2	Yageo	CC0603MRX7R7BB104
Capacitor	C3,C6,C8	CAP,1µF,16V,±10%,SMD	3	Yageo	CC0603KRX7R7BB105
Capacitor	C4,C5	CAP,33pF,50V,±5%,SMD	2	Yageo	CQ0603JRNPO9BN330
Capacitor	C7	CAP,10nF,16V,±10%,SMD	1	Yageo	CC0603KRX7R7BB103
Capacitor	C9	CAP,10µF,16V,±20%,SMD	1	Yageo	CC0603MRX5R7BB106
Button	K1	Button SMD	1		

Bill of Materials, refer to Figure 3 above.

Note 1: The value of these resistors on the evaluation board is 20Ω. For PVCC=5V and red LED application, prefer 51Ω for these resistors as shown in datasheet Figure 1.

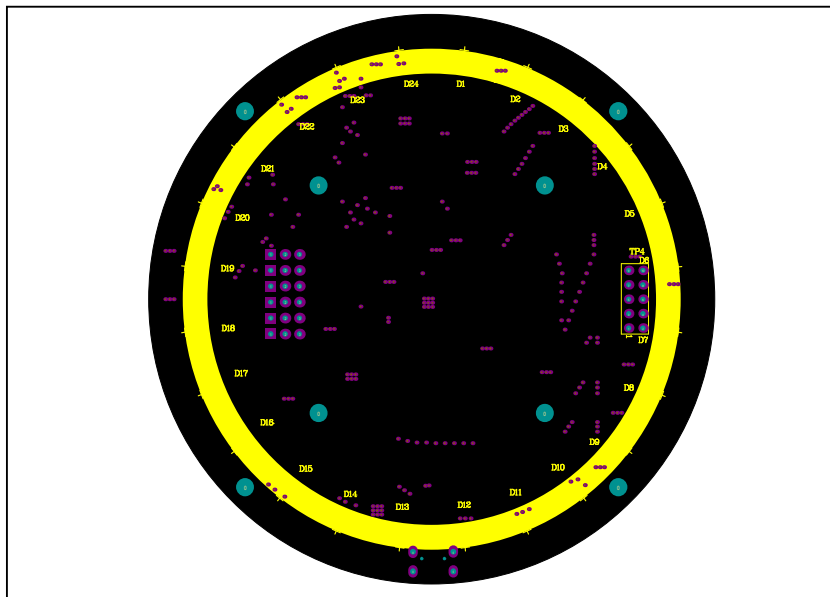

Figure 5: Board Component Placement Guide - Top Layer

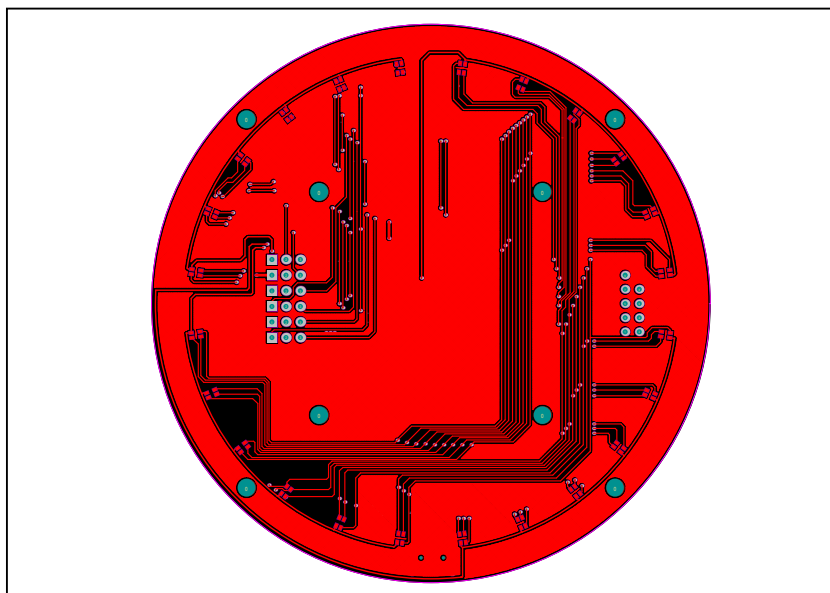

Figure 6: Board PCB Layout - Top Layer

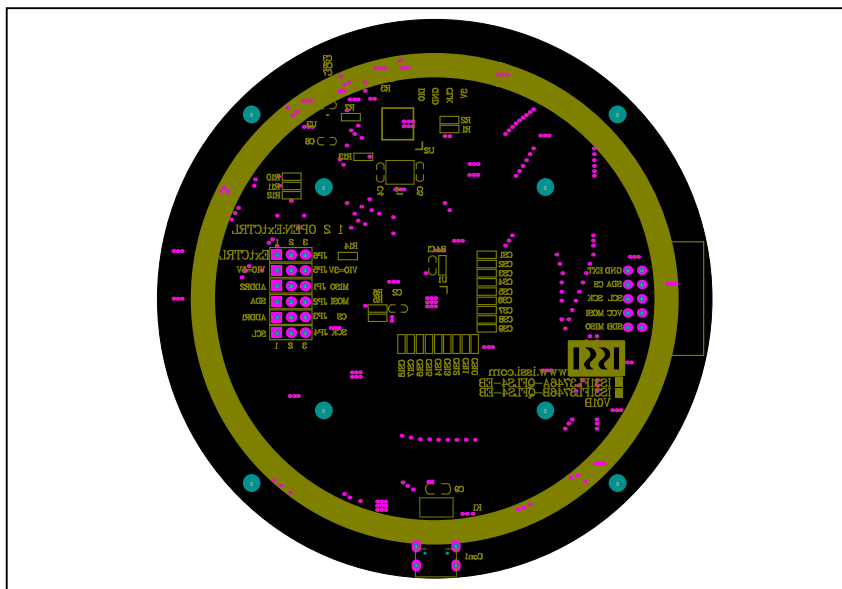

Figure 7: Board Component Placement Guide - Bottom Layer

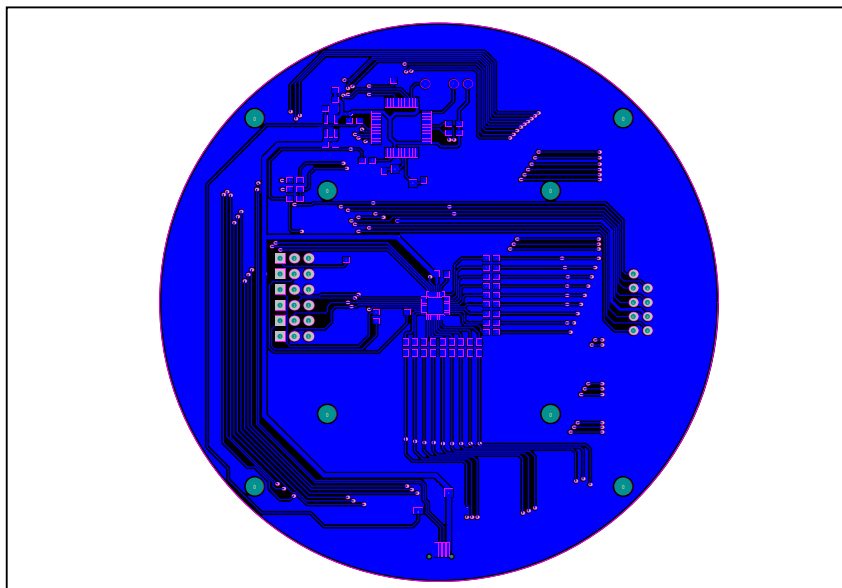

Figure 8: Board PCB Layout - Bottom Layer

Copyright © 2019 Integrated Silicon Solution, Inc. All rights reserved. ISSI reserves the right to make changes to this specification and its products at any time without notice. ISSI assumes no liability arising out of the application or use of any information, products or services described herein. Customers are advised to obtain the latest version of this device specification before relying on any published information and before placing orders for products.

Integrated Silicon Solution, Inc. does not recommend the use of any of its products in life support applications where the failure or malfunction of the product can reasonably be expected to cause failure of the life support system or to significantly affect its safety or effectiveness. Products are not authorized for use in such applications unless Integrated Silicon Solution, Inc. receives written assurance to its satisfaction, that:

- a.) the risk of injury or damage has been minimized;
- b.) the user assume all such risks; and
- c.) potential liability of Integrated Silicon Solution, Inc is adequately protected under the circumstances

REVISION HISTORY

Revision	Detail Information	Date
A	Initial release	2018.09.10
B	Fix silk screen labels for figure 6, 8	2019.08.26

24-RGB MATRIX LED DRIVER

APPENDIX I : IS31FL3746A Arduino Test Code V01A

```

#include<Wire.h>
#include<avr/pgmspace.h>

#define Addr_GND_GND 0xC0

void setup() {
    // put your setup code here, to run once:
    pinMode(13, OUTPUT); // ARDUINO BOARD LED control
    Wire.begin();
    Wire.setClock(400000); // I2C 400kHz
}

byte PWM_Gamma64[64]=
{
    0x00,0x01,0x02,0x03,0x04,0x05,0x06,0x07,
    0x08,0x09,0x0b,0x0d,0x0f,0x11,0x13,0x16,
    0x1a,0x1c,0x1d,0x1f,0x22,0x25,0x28,0x2e,
    0x34,0x38,0x3c,0x40,0x44,0x48,0x4b,0x4f,
    0x55,0x5a,0x5f,0x64,0x69,0x6d,0x72,0x77,
    0x7d,0x80,0x88,0x8d,0x94,0x9a,0xa0,0xa7,
    0xac,0xb0,0xb9,0xbf,0xc6,0xcb,0xcf,0xd6,
    0xe1,0xe9,0xed,0xf1,0xf6,0xfa,0xfe,0xff
};

void IS_IIC_WriteByte(uint8_t Dev_Add,uint8_t Reg_Add,uint8_t Reg_Dat) // writing an LED register
{
    Wire.beginTransmission(Dev_Add/2);
    Wire.write(Reg_Add); // sends regaddress
    Wire.write(Reg_Dat); // sends regaddress
    Wire.endTransmission(); // stop transmitting
}

void loop() {
    // put your main code here, to run repeatedly:
    mainloop();
}

void Init3746A(void)
{
    int i,j;
    IS_IIC_WriteByte(Addr_GND_GND,0xfe,0xc5);
    IS_IIC_WriteByte(Addr_GND_GND,0xfd,0x00); // page 0
    for(i=0;i<0x48;i++)
    {
        IS_IIC_WriteByte(Addr_GND_GND,i,0); // PWM
    }
    IS_IIC_WriteByte(Addr_GND_GND,0xfe,0xc5);
    IS_IIC_WriteByte(Addr_GND_GND,0xfd,0x01); // page 1
    for(i=1;i<0x48;i++)
    {
        IS_IIC_WriteByte(Addr_GND_GND,i,0xff); // scaling
    }

    IS_IIC_WriteByte(Addr_GND_GND,0x52,0x70);
    IS_IIC_WriteByte(Addr_GND_GND,0x51,0xFF); // GCC
    IS_IIC_WriteByte(Addr_GND_GND,0x50,0x01); //
}

void mainloop(void) //
{
    int i,j;
    Init3746A();
    digitalWrite(13, LOW); // turn the ARDUINO BOARD LED on (HIGH is the voltage level)
    while(1)
    {
        //BLUE
        digitalWrite(13, HIGH); // turn the ARDUINO BOARD LED on (HIGH is the voltage level)
        IS_IIC_WriteByte(Addr_GND_GND,0xfe,0xc5);
        IS_IIC_WriteByte(Addr_GND_GND,0xfd,0x00); // page 0
        for(j=0;j<64;j++)
        {

```

24-RGB MATRIX LED DRIVER

```

    for(i=1;i<0x48;i=i+3)
    {
        IS_IIC_WriteByte(Addr_GND_GND,i,PWM_Gamma64[j]);//PWM
    }
}
delay(500);

digitalWrite(13, LOW); // turn the ARDUINO BOARD LED OFF (HIGH is the voltage level)
IS_IIC_WriteByte(Addr_GND_GND,0xfe,0xc5);
IS_IIC_WriteByte(Addr_GND_GND,0xfd,0x00);//page 0
for(j=63;j>=0;j--)
{
    for(i=1;i<0x48;i=i+3)
    {
        IS_IIC_WriteByte(Addr_GND_GND,i,PWM_Gamma64[j]);//PWM
    }
}
delay(500);

//GREEN
digitalWrite(13, HIGH); // turn the ARDUINO BOARD LED on (HIGH is the voltage level)
IS_IIC_WriteByte(Addr_GND_GND,0xfe,0xc5);
IS_IIC_WriteByte(Addr_GND_GND,0xfd,0x00);//page 0
for(j=0;j<64;j++)
{
    for(i=2;i<0x48;i=i+3)
    {
        IS_IIC_WriteByte(Addr_GND_GND,i,PWM_Gamma64[j]);//PWM
    }
}
delay(500);

digitalWrite(13, LOW); // turn the ARDUINO BOARD LED OFF (HIGH is the voltage level)
IS_IIC_WriteByte(Addr_GND_GND,0xfe,0xc5);
IS_IIC_WriteByte(Addr_GND_GND,0xfd,0x00);//page 0
for(j=63;j>=0;j--)
{
    for(i=2;i<0x48;i=i+3)
    {
        IS_IIC_WriteByte(Addr_GND_GND,i,PWM_Gamma64[j]);//PWM
    }
}
delay(500);

//RED
digitalWrite(13, HIGH); // turn the ARDUINO BOARD LED on (HIGH is the voltage level)
IS_IIC_WriteByte(Addr_GND_GND,0xfe,0xc5);
IS_IIC_WriteByte(Addr_GND_GND,0xfd,0x00);//page 0
for(j=0;j<64;j++)
{
    for(i=3;i<0x49;i=i+3)
    {
        IS_IIC_WriteByte(Addr_GND_GND,i,PWM_Gamma64[j]);//PWM
    }
}
delay(500);

digitalWrite(13, LOW); // turn the ARDUINO BOARD LED OFF (HIGH is the voltage level)
IS_IIC_WriteByte(Addr_GND_GND,0xfe,0xc5);
IS_IIC_WriteByte(Addr_GND_GND,0xfd,0x00);//page 0
for(j=63;j>=0;j--)
{
    for(i=3;i<0x49;i=i+3)
    {
        IS_IIC_WriteByte(Addr_GND_GND,i,PWM_Gamma64[j]);//PWM
    }
}
delay(500);

//WHITE
digitalWrite(13, HIGH); // turn the ARDUINO BOARD LED on (HIGH is the voltage level)
IS_IIC_WriteByte(Addr_GND_GND,0xfe,0xc5);
IS_IIC_WriteByte(Addr_GND_GND,0xfd,0x00);//page 0
for(j=0;j<64;j++)

```

24-RGB MATRIX LED DRIVER

```
{
  for(i=1;i<0x49;i++)
  {
    IS_IIC_WriteByte(Addr_GND_GND,i,PWM_Gamma64[j]);//PWM}
  }
  delay(500);

digitalWrite(13, LOW); // turn the ARDUINO BOARD LED OFF (HIGH is the voltage level)
IS_IIC_WriteByte(Addr_GND_GND,0xfe,0xc5);
IS_IIC_WriteByte(Addr_GND_GND,0xfd,0x00);//page 0
for(j=63;j>=0;j--)
{
  for(i=1;i<0x49;i++)
  {
    IS_IIC_WriteByte(Addr_GND_GND,i,PWM_Gamma64[j]);//PWM}
  }
  delay(500);
}
}
```

Компания «Life Electronics» занимается поставками электронных компонентов импортного и отечественного производства от производителей и со складов крупных дистрибьюторов Европы, Америки и Азии.

С конца 2013 года компания активно расширяет линейку поставок компонентов по направлению коаксиальный кабель, кварцевые генераторы и конденсаторы (керамические, пленочные, электролитические), за счёт заключения дистрибьюторских договоров

Мы предлагаем:

- Конкурентоспособные цены и скидки постоянным клиентам.
- Специальные условия для постоянных клиентов.
- Подбор аналогов.
- Поставку компонентов в любых объемах, удовлетворяющих вашим потребностям.
- Приемлемые сроки поставки, возможна ускоренная поставка.
- Доставку товара в любую точку России и стран СНГ.
- Комплексную поставку.
- Работу по проектам и поставку образцов.
- Формирование склада под заказчика.
- Сертификаты соответствия на поставляемую продукцию (по желанию клиента).
- Тестирование поставляемой продукции.
- Поставку компонентов, требующих военную и космическую приемку.
- Входной контроль качества.
- Наличие сертификата ISO.

В составе нашей компании организован Конструкторский отдел, призванный помогать разработчикам, и инженерам.

Конструкторский отдел помогает осуществить:

- Регистрацию проекта у производителя компонентов.
- Техническую поддержку проекта.
- Защиту от снятия компонента с производства.
- Оценку стоимости проекта по компонентам.
- Изготовление тестовой платы монтаж и пусконаладочные работы.



Тел: +7 (812) 336 43 04 (многоканальный)
Email: org@lifeelectronics.ru