

- **Low-loss SAW Filter**
- **Surface-mount 3.0 x 3.0 x 1.4 mm Package**
- **Complies with Directive 2002/95/EC (RoHS)**

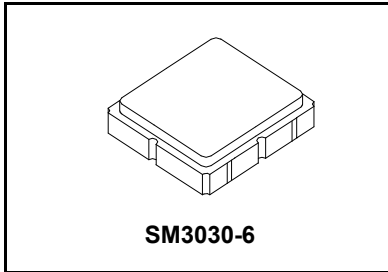

SF2204E

**1900 MHz
SAW Filter**



Absolute Maximum Ratings

Rating	Value	Units
Input Power Level	10	dBm
DC Voltage on any Non-ground Terminal	3	V
Operating Temperature Range	-20 to +70	°C
Storage Temperature Range in Tape and Reel	-40 to +85	°C
Solder Reflow Temperature, 10 seconds, 5 cycles maximum	260	°C

Electrical Characteristics

Characteristic	Sym	Notes	Min	Typ	Max	Units
Center Frequency	F_C			1900		MHz
Insertion Loss, 1880 to 1920 MHz	IL			2.7	3.5	dB
Amplitude Ripple, 1880 to 1920 MHz				1.0	1.5	dB _{P-P}
Group Delay Ripple, 1880 to 1920 MHz				10	40	ns _{P-P}
Input VSWR, 1880 to 1920 MHz				1.5:1	2.0:1	
Output VSWR, 1880 to 1920 MHz				1.5:1	2.0:1	
Attenuation Referenced to 0 dB						
0.3 to 1000 MHz			30	35		dB
1000 to 1700 MHz			30	35		
1700 to 1830 MHz			32	38		
1970 to 2400 MHz			38	45		
2400 to 3000 MHz			30	40		
3000 to 4000 MHz			25	34		
Source Impedance	Z_S			50		Ω
Load Impedance	Z_L			50		

Case Style	SM3030-6 3.0 x 3.0 mm Nominal Footprint					
Lid Symbolization (Y=year, WW=week, S=shift) dot=pin 1 indicator	936, YWWS					
Standard Reel Quantity	Reel Size 7 Inch					500 Pieces/Reel
	Reel Size 13 Inch					3000 Pieces/Reel

Electrical Connections

Connection	Terminals
Input	5
Output	2
Ground	All Others

CAUTION: Electrostatic Sensitive Device. Observe precautions for handling.

NOTES:

1. Unless noted otherwise, all specifications apply over the operating temperature range with filter soldered to the specified demonstration board with impedance matching to 50 Ω and measured with 50 Ω network analyzer.
2. Unless noted otherwise, all frequency specifications are referenced to the nominal center frequency, f_c .
3. Rejection is measured as attenuation below the minimum IL point in the passband. Rejection in final user application is dependent on PCB layout and external impedance matching design. See Application Note No. 42 for details.
4. "LRIP" or "L" after the part number indicates "low rate initial production" and "ENG" or "E" indicates "engineering prototypes."
5. The design, manufacturing process, and specifications of this filter are subject to change.
6. Either Port 1 or Port 2 may be used for either input or output in the design. However, impedances and impedance matching may vary between Port 1 and Port 2, so that the filter must always be installed in one direction per the circuit design.
7. US and international patents may apply.
8. Murata, stylized Murata logo, and Murata N.A., Inc. are registered trademarks of Murata Manufacturing Co., Ltd.

Filter Passband Response, 1800 to 2000 MHz

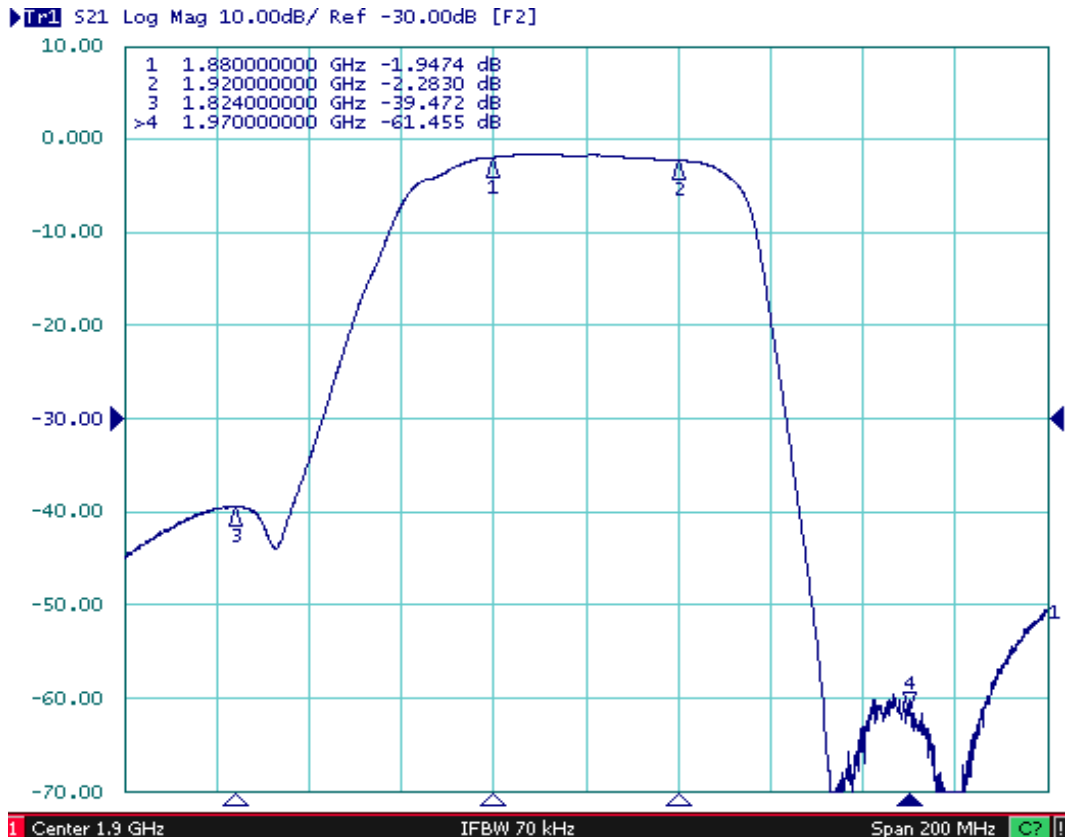

Filter Test Circuit

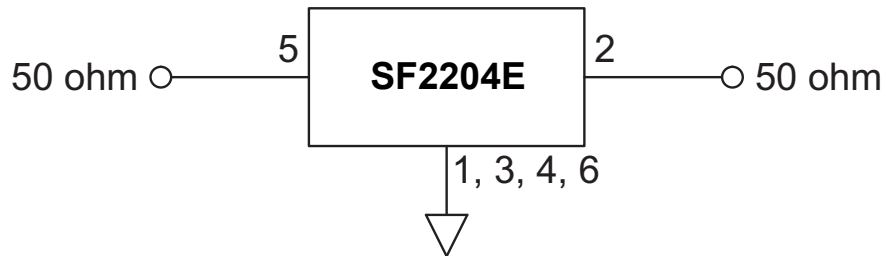

Filter Broadband Response, 300 kHz to 4000 MHz

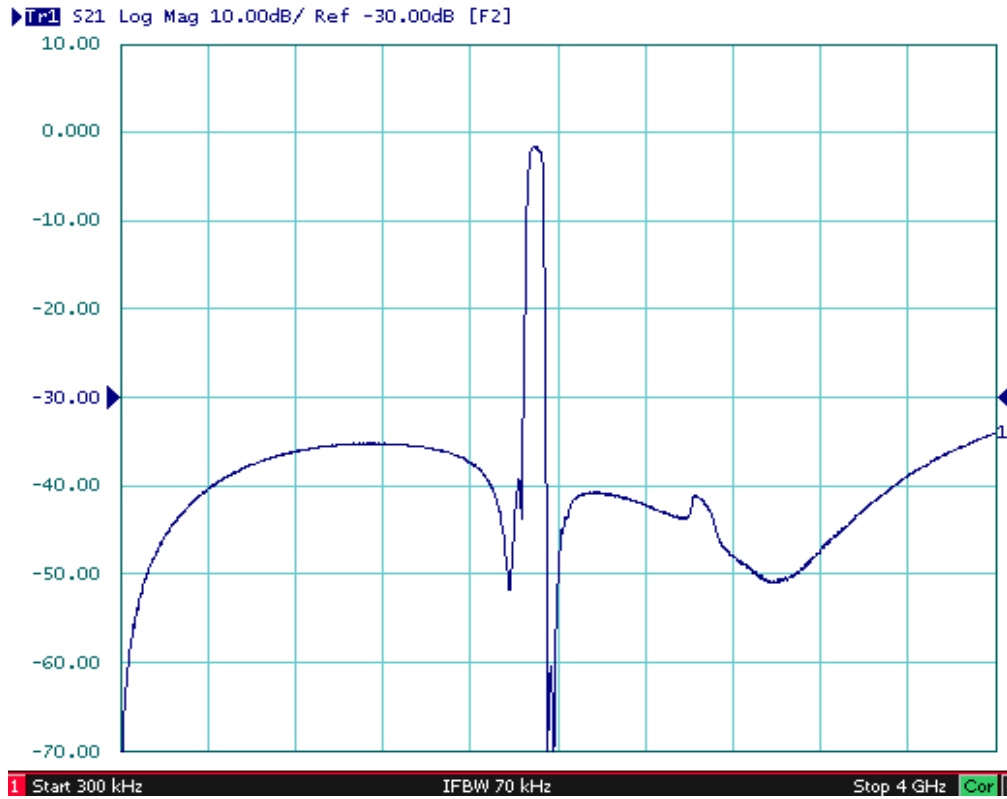

Filter Group Delay Plot, 1800 to 2000 MHz

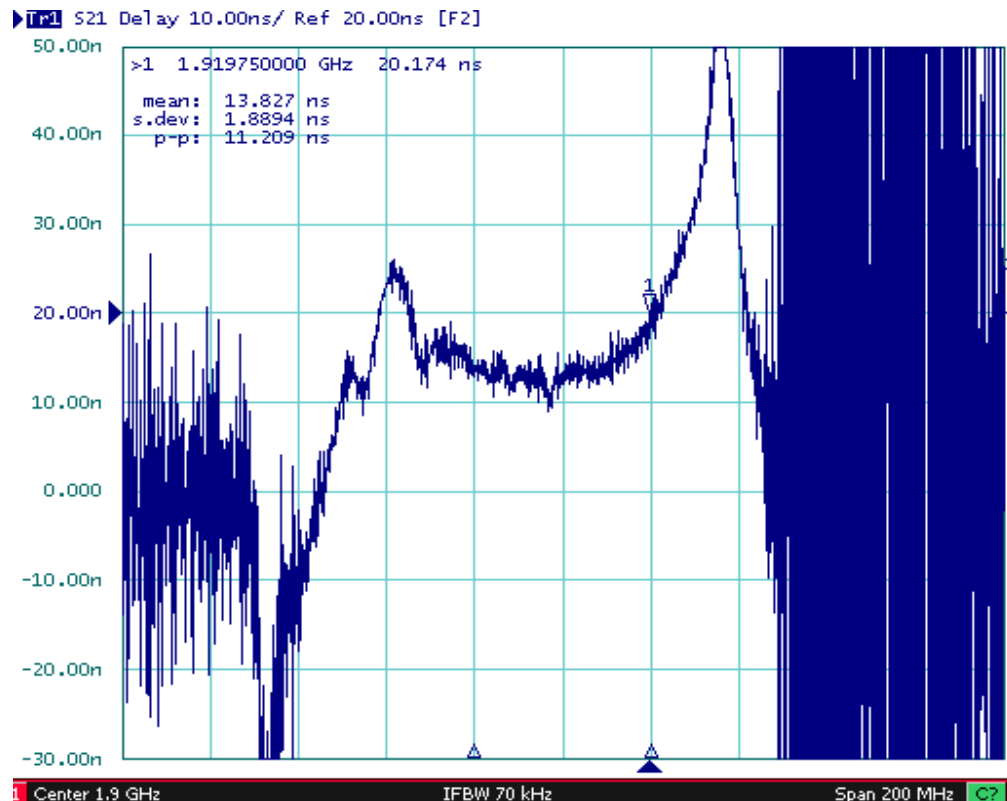

Input and Output VSWR Plots

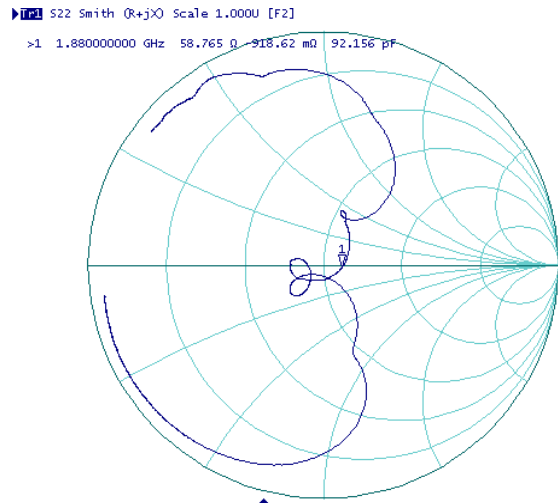
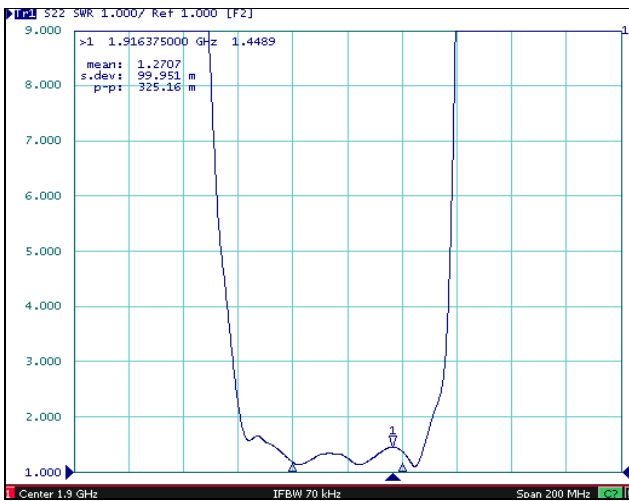
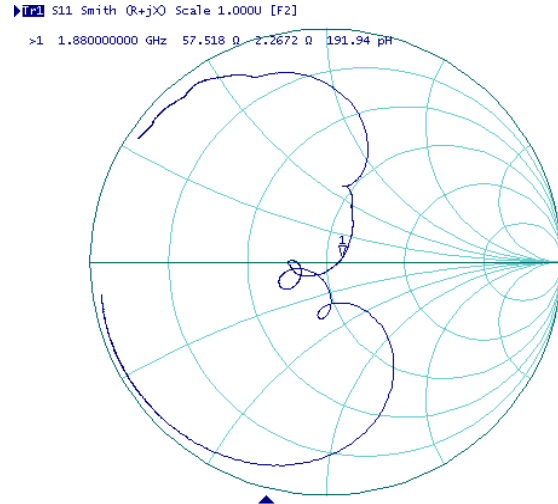

SM3030-6 Case

6-Terminal Ceramic Surface-Mount Case 3.0 X 3.0 mm Nominal Footprint

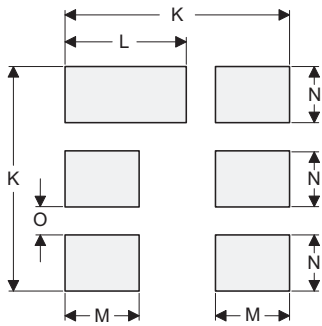
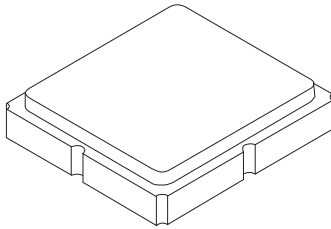

PCB Footprint Top View

Case and PCB Footprint Dimensions

Dimension	mm			Inches		
	Min	Nom	Max	Min	Nom	Max
A	2.87	3.00	3.13	0.113	0.118	0.123
B	2.87	3.00	3.13	0.113	0.118	0.123
C	1.12	1.25	1.38	0.044	0.049	0.054
D	0.77	0.90	1.03	0.030	0.035	0.040
E	2.67	2.80	2.93	0.105	0.110	0.115
F	1.47	1.60	1.73	0.058	0.063	0.068
G	0.72	0.85	0.98	0.028	0.033	0.038
H	1.37	1.50	1.63	0.054	0.059	0.064
I	0.47	0.60	0.73	0.019	0.024	0.029
J	1.17	1.30	1.43	0.046	0.051	0.056
K		3.20			0.126	
L		1.70			0.067	
M		1.05			0.041	
N		0.81			0.032	
O		0.38			0.015	

Case Materials

Materials	
Solder Pad Plating	0.3 to 1.0 μ m Gold over 1.27 to 8.89 μ m Nickel
Lid Plating	2.0 to 3.0 μ m Nickel
Body	Al ₂ O ₃ Ceramic
Pb Free	

TOP VIEW

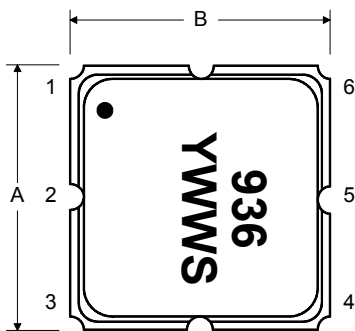

BOTTOM VIEW

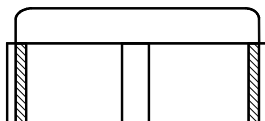
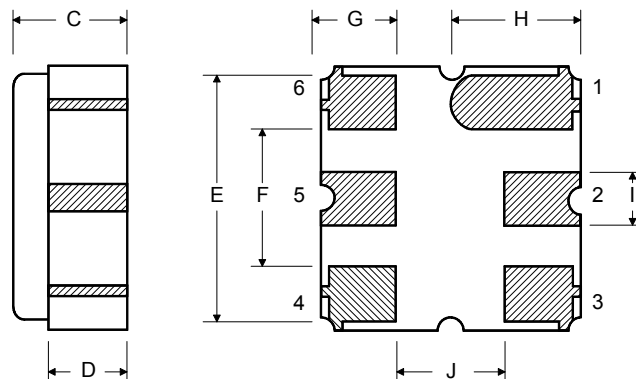

Typical Solder Reflow Profile

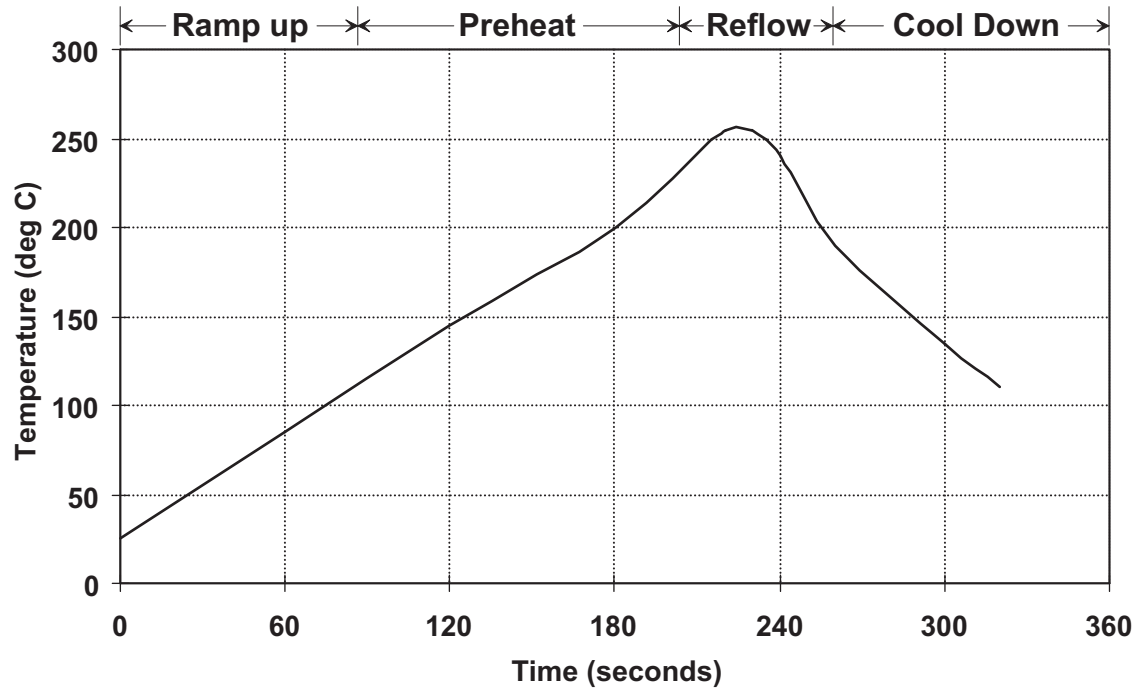

Компания «Life Electronics» занимается поставками электронных компонентов импортного и отечественного производства от производителей и со складов крупных дистрибьюторов Европы, Америки и Азии.

С конца 2013 года компания активно расширяет линейку поставок компонентов по направлению коаксиальный кабель, кварцевые генераторы и конденсаторы (керамические, пленочные, электролитические), за счёт заключения дистрибьюторских договоров

Мы предлагаем:

- Конкуренеспособные цены и скидки постоянным клиентам.
- Специальные условия для постоянных клиентов.
- Подбор аналогов.
- Поставку компонентов в любых объемах, удовлетворяющих вашим потребностям.
- Приемлемые сроки поставки, возможна ускоренная поставка.
- Доставку товара в любую точку России и стран СНГ.
- Комплексную поставку.
- Работу по проектам и поставку образцов.
- Формирование склада под заказчика.
- Сертификаты соответствия на поставляемую продукцию (по желанию клиента).
- Тестирование поставляемой продукции.
- Поставку компонентов, требующих военную и космическую приемку.
- Входной контроль качества.
- Наличие сертификата ISO.

В составе нашей компании организован Конструкторский отдел, призванный помогать разработчикам, и инженерам.

Конструкторский отдел помогает осуществить:

- Регистрацию проекта у производителя компонентов.
- Техническую поддержку проекта.
- Защиту от снятия компонента с производства.
- Оценку стоимости проекта по компонентам.
- Изготовление тестовой платы монтаж и пусконаладочные работы.



Тел: +7 (812) 336 43 04 (многоканальный)

Email: org@lifeelectronics.ru