

### 4 PIN DIP ZERO-CROSS TRIAC DRIVER PHOTOCOUPLER ELT304X, ELT306X, ELT308X Series



#### Features:

- Peak breakdown voltage
  - 400V: ELT304X
  - 600V: ELT306X
  - 800V: ELT308X
- High isolation voltage between input and output (Viso=5000 V rms )
- Zero voltage crossing
- Pb free and RoHS compliant.
- UL and cUL approved(No. E214129)
- VDE approved (No. 40028391)
- SEMKO approved
- NEMKO approved
- DEMKO approved
- FIMKO approved

#### Schematic

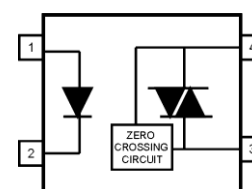

#### Pin Configuration

1. Anode
2. Cathode
3. Terminal
4. Terminal

#### Description

The ELT304X, ELT306X and ELT308X series of devices each consist of a GaAs infrared emitting diode optically coupled to a monolithic silicon zero voltage crossing photo triac.

They are designed for use with a discrete power triac in the interface of logic systems to equipment powered from 110 to 380 VAC lines, such as solid-state relays, industrial controls, motors, solenoids and consumer appliances.

#### Applications

- Solenoid/valve controls
- Light controls
- Static power switch
- AC motor drivers
- E.M. contactors
- Temperature controls
- AC Motor starters

**Absolute Maximum Ratings (Ta=25°C)**

Parameter		Symbol	Rating	Unit
Input	Forward current	$I_F$	60	mA
	Reverse voltage	$V_R$	6	V
	Power dissipation	$P_D$	100	mW
Output	Off-state Output Terminal Voltage	ELT304X	400	V
		ELT306X	600	
		ELT308X	800	
	Peak Repetitive Surge Current	$I_{TSM}$	1	A
	Power dissipation	$P_C$	300	mW
Total power dissipation	$P_{TOT}$	330	mW	
Isolation voltage <sup>*1</sup>	$V_{ISO}$	5000	Vrms	
Operating temperature	$T_{OPR}$	-55 to 100	°C	
Storage temperature	$T_{STG}$	-55 to 125	°C	
Soldering Temperature <sup>*2</sup>	$T_{SOL}$	260	°C	

Notes:

\*1 AC for 1 minute, R.H.= 40 ~ 60% R.H. In this test, pins 1 & 2 are shorted together, and pins 3 & 4 are shorted together.

\*2 For 10 seconds

**Electro-Optical Characteristics (Ta=25°C unless specified otherwise)**

**Input**

Parameter	Symbol	Min.	Typ.*	Max.	Unit	Condition
Forward Voltage	$V_F$	-	-	1.5	V	$I_F = 30\text{mA}$
Reverse Leakage current	$I_R$	-	-	10	$\mu\text{A}$	$V_R = 6\text{V}$

**Output**

Parameter	Symbol	Min.	Typ.*	Max.	Unit	Condition
Peak Blocking Current	$I_{\text{DRM}}$	-	-	100	nA	$V_{\text{DRM}} = \text{Rated } V_{\text{DRM}}$ $I_F = 0\text{mA}$
				500		
Peak On-state Voltage	$V_{\text{TM}}$	-	-	3	V	$I_{\text{TM}} = 100\text{mA peak}$ , $I_F = \text{Rated } I_{\text{FT}}$
Critical Rate of Rise off-state Voltage	$dv/dt$	1000	-	-	V/ $\mu\text{s}$	$V_{\text{PEAK}} = \text{Rated } V_{\text{DRM}}$ , $I_F = 0$ (Fig. 10)
		600	-	-		
Inhibit Voltage (MT1-MT2 voltage above which device will not trigger)	$V_{\text{INH}}$	-	-	20	V	$I_F = \text{Rated } I_{\text{FT}}$
Leakage in Inhibited State	$I_{\text{DRM2}}$	-	-	500	$\mu\text{A}$	$I_F = \text{Rated } I_{\text{FT}}$ , $V_{\text{DRM}} = \text{Rated } V_{\text{DRM}}$ , off state

**Transfer Characteristics**

Parameter	Symbol	Min.	Typ.*	Max.	Unit	Condition
LED Trigger Current	$I_{\text{FT}}$	-	-	15	mA	Main terminal Voltage=3V
				10		
				5		
				280		
Holding Current	$I_H$	-	280	-	$\mu\text{A}$	

\* Typical values at  $T_a = 25^\circ\text{C}$

Typical Electro-Optical Characteristics Curves

Figure 1. Forward Current vs Forward Voltage

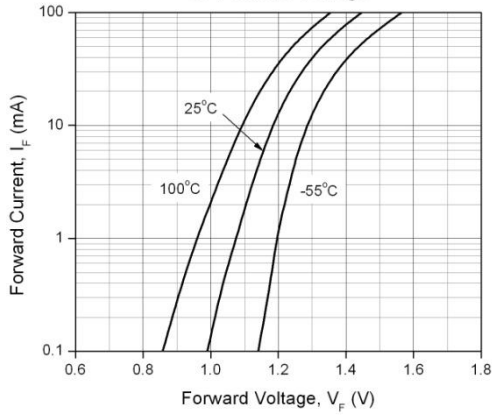

Figure 2. On-State Characteristics

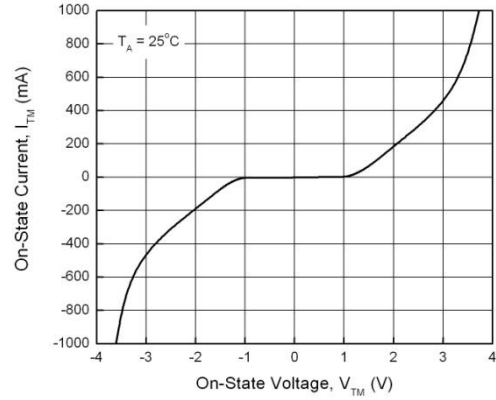

Figure 3. Holding Current vs. Ambient Temperature

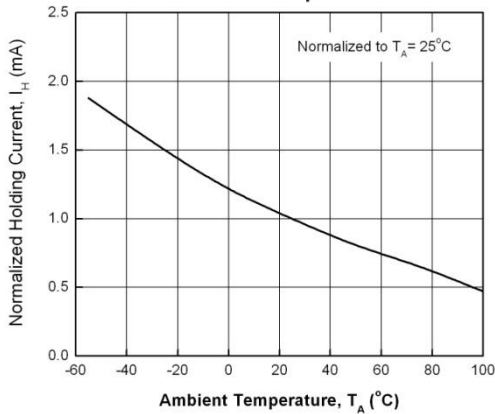

Figure 4. LED Current Required to Trigger vs. LED Pulse Width

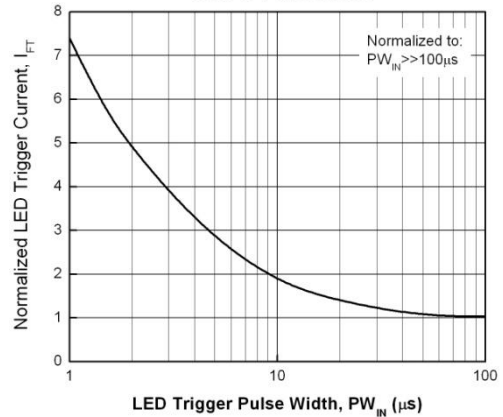

Figure 5. Leakage Current vs. Ambient Temperature

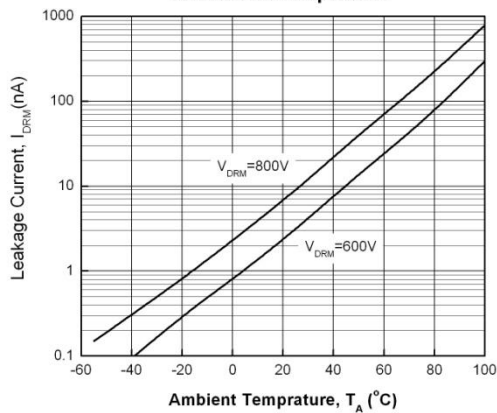

Figure 6. LED Trigger Current vs. Ambient Temperature

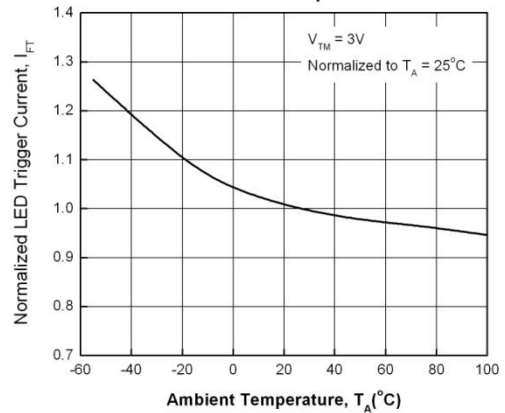

Figure 7. Off-State Output Terminal Voltage vs. Ambient Temperature

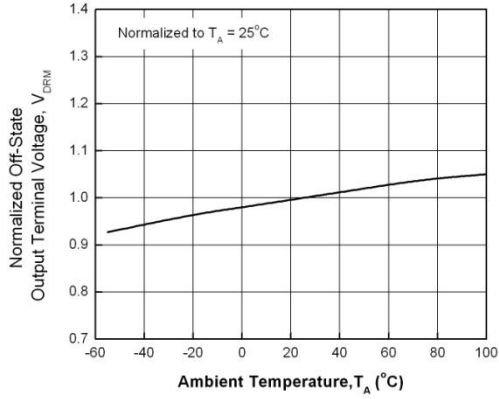

Figure 8. Leakage in Inhibit State vs. Ambient Temperature

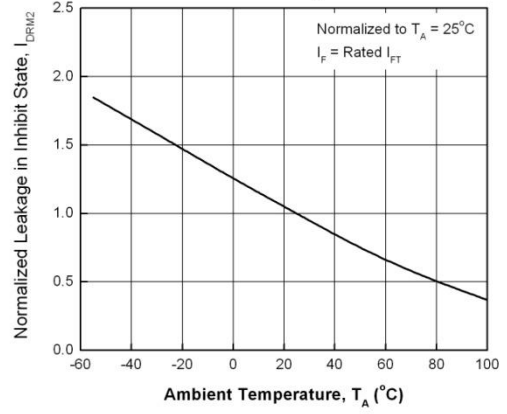

Figure 9. Inhibit Voltage vs. Ambient Temperature

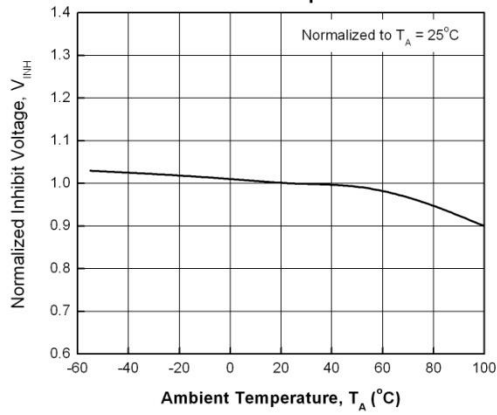
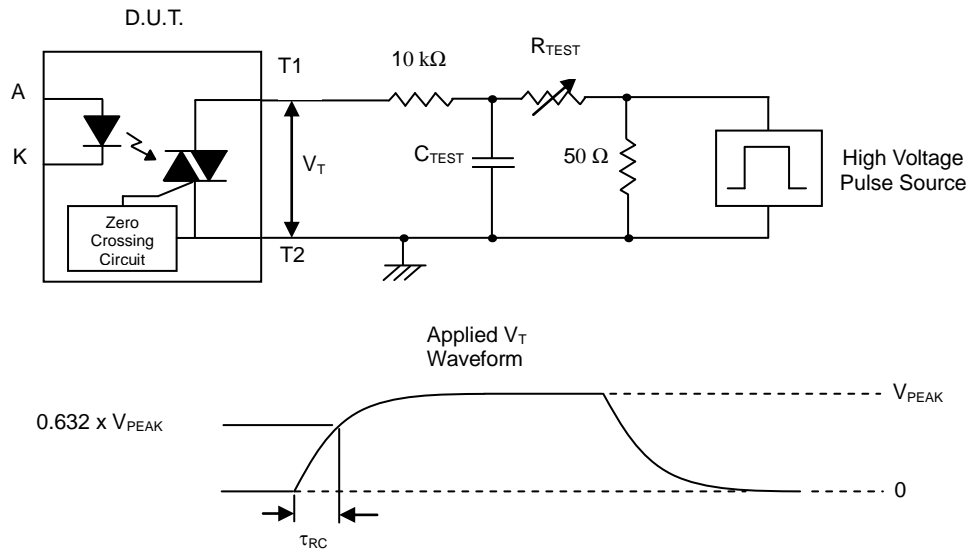

Figure 10. Static dv/dt Test Circuit & Waveform



### Measurement Method

The high voltage pulse is set to the required  $V_{PEAK}$  value and applied to the D.U.T. output side through the RC circuit above. LED current is not applied. The waveform  $V_T$  is monitored using a x100 scope probe. By varying  $R_{TEST}$ , the dv/dt (slope) is increased, until the D.U.T. is observed to trigger (waveform collapses). The dv/dt is then decreased until the D.U.T. stops triggering. At this point,  $\tau_{RC}$  is recorded and the dv/dt calculated.

$$dv/dt = \frac{0.632 \times V_{PEAK}}{\tau_{RC}}$$

For example,  $V_{PEAK} = 600V$  for ELT306X series. The dv/dt value is calculated as follows:

$$dv/dt = \frac{0.63 \times 600}{\tau_{RC}} = \frac{378}{\tau_{RC}}$$

**Order Information**

**Part Number**

**ELT304X(Y)(Z)-V**  
 or **ELT306X(Y)(Z)-V**  
 or **ELT308X(Y)(Z)-V**

**Note**

Note

X = Part No. (1, 2, or 3)

Y = Lead form option (S, S1, M or none)

Z = Tape and reel option (TA, TB, TU, TD or none).

V = VDE safety approved option

Option	Description	Packing quantity
None	Standard DIP-4	100 units per tube
M	Wide lead bend (0.4 inch spacing)	100 units per tube
S (TA)	Surface mount lead form + TA tape & reel option	1000 units per reel
S (TB)	Surface mount lead form + TB tape & reel option	1000 units per reel
S1 (TA)	Surface mount lead form (low profile) + TA tape & reel option	1000 units per reel
S1 (TB)	Surface mount lead form (low profile) + TB tape & reel option	1000 units per reel
S (TU)	Surface mount lead form + TU tape & reel option	1500 units per reel
S (TD)	Surface mount lead form + TD tape & reel option	1500 units per reel
S1 (TU)	Surface mount lead form (low profile) + TU tape & reel option	1500 units per reel
S1 (TD)	Surface mount lead form (low profile) + TD tape & reel option	1500 units per reel

## Package Dimension (Dimensions in mm)

### Standard DIP Type

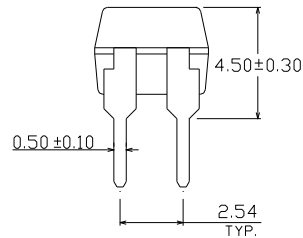
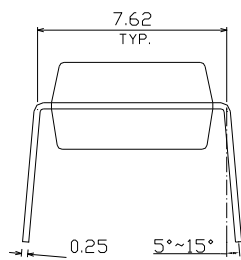
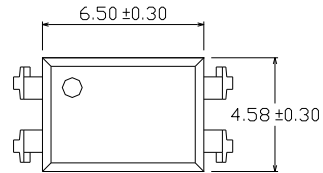

### Option M Type

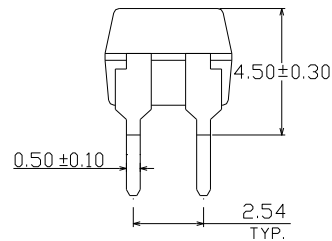
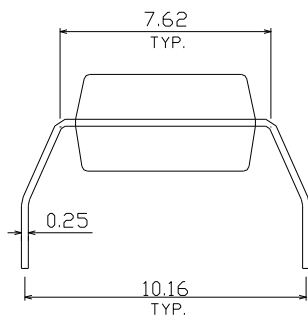
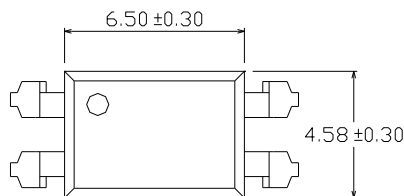



**Option S Type**

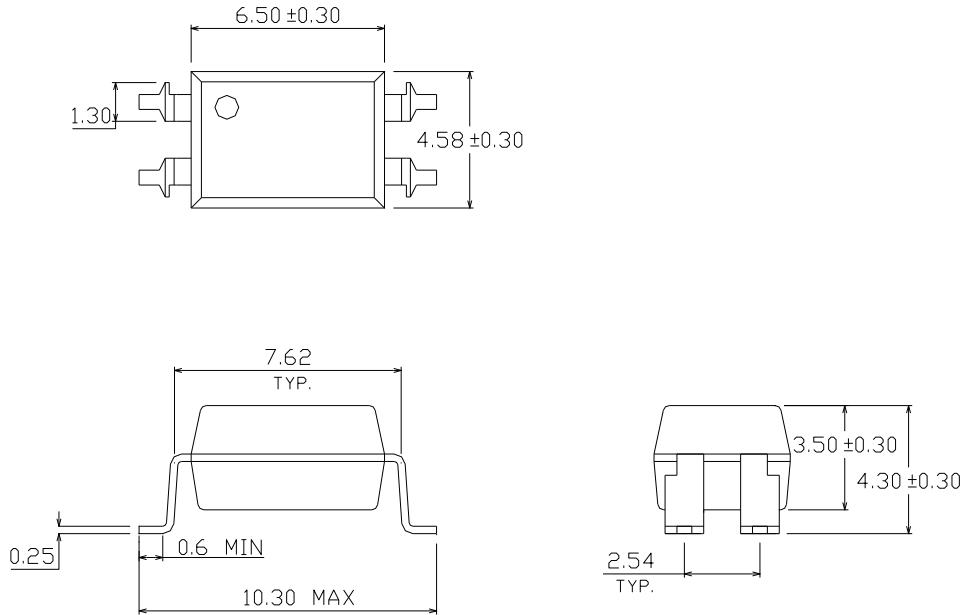

**Option S1 Type**

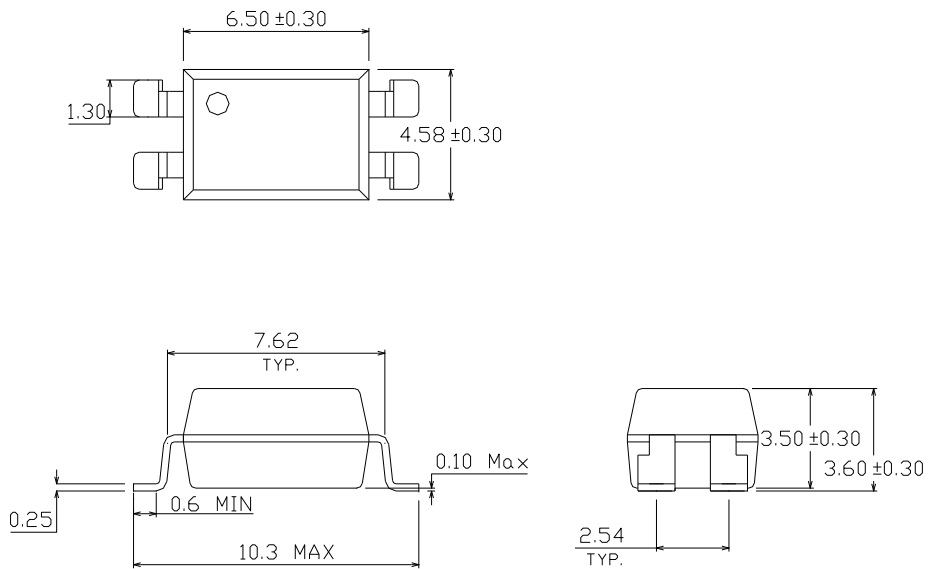

**Recommended pad layout for surface mount leadform**

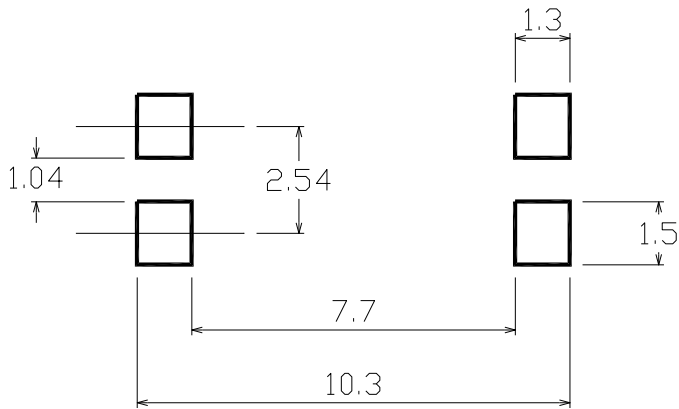

**Device Marking**



**Notes**

- EL denotes Everlight
- T3083 denotes Device Number
- Y denotes 1 digit Year code
- WW denotes 2 digit Week code
- V denotes VDE option

**Tape & Reel Packing Specifications**

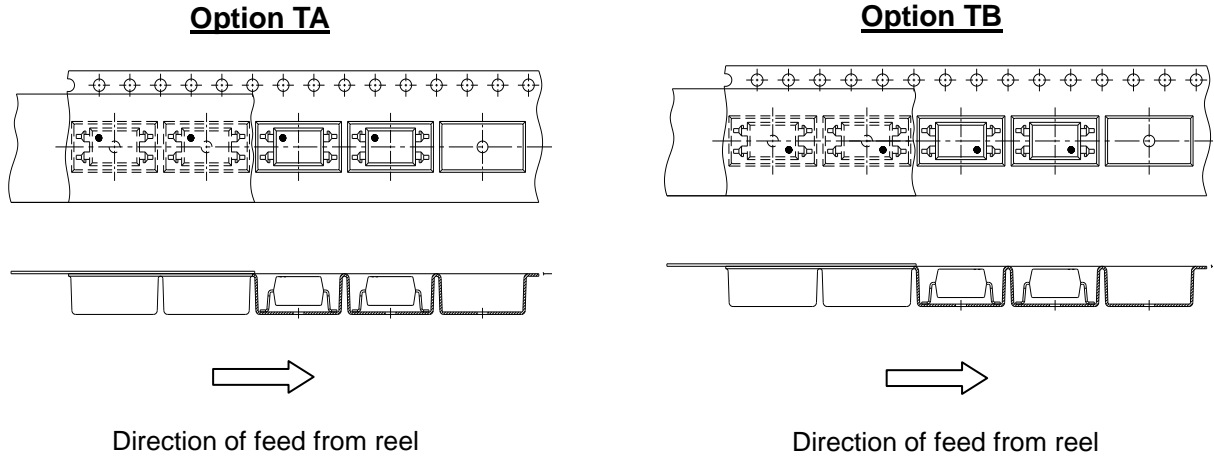

**Tape dimensions**

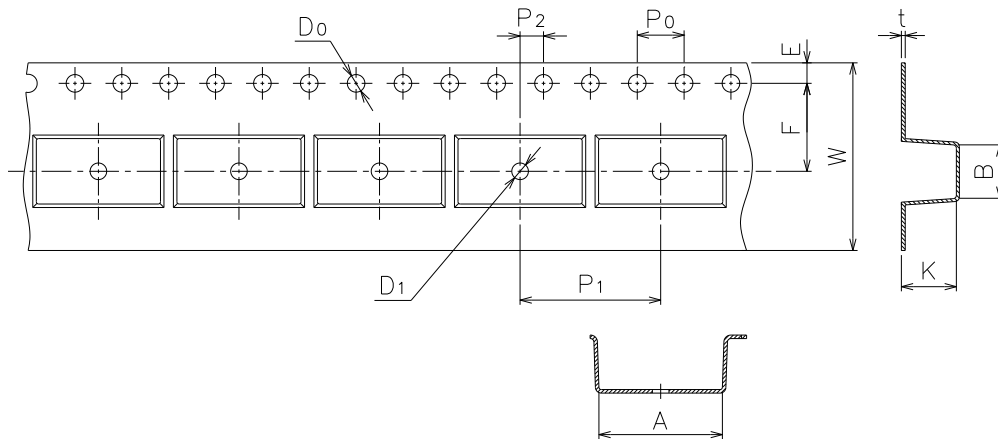

Dimension No.	A	B	Do	D1	E	F
Dimension (mm)	10.5±0.1	4.65±0.1	1.55±0.1	1.50±0.1	1.75±0.1	7.5±0.1

Dimension No.	Po	P1	P2	t	W	K
Dimension (mm)	4.0±0.1	12.0±0.1	2.0±0.1	0.35±0.1	16.0±0.3	4.75±0.1

**Option TD**

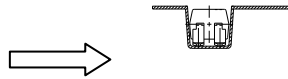
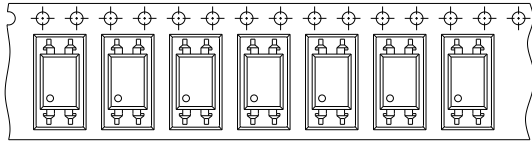

Direction of feed from reel

**Option TU**

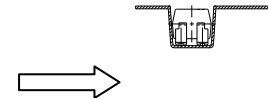
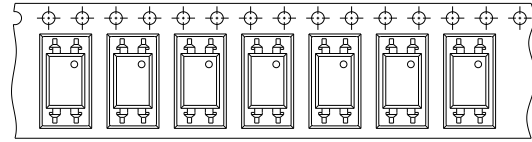

Direction of feed from reel

**Tape dimensions**

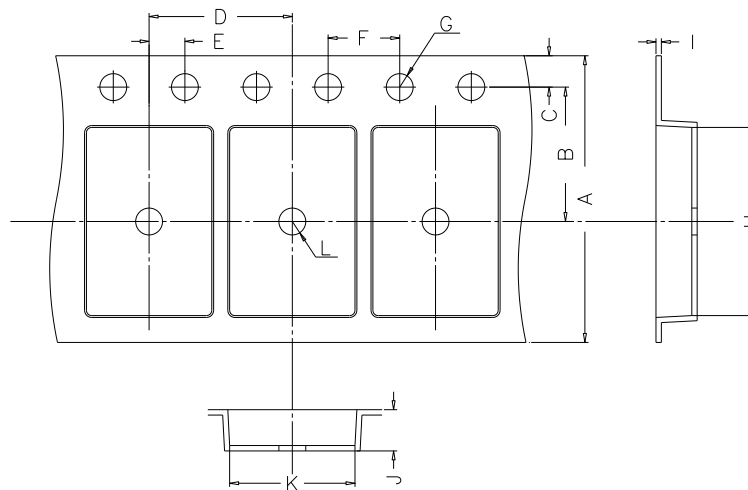

Dimension No.	<b>A</b>	<b>B</b>	<b>C</b>	<b>D</b>	<b>E</b>	<b>F</b>
Dimension(mm)	16.00±0.3	7.5±0.1	1.75±0.1	8.0±0.1	2.0±0.1	4.0±0.1
Dimension No.	<b>G</b>	<b>H</b>	<b>I</b>	<b>J</b>	<b>K</b>	<b>L</b>
Dimension(mm)	1.55±0.05	10.4±0.1	0.4±0.05	4.60±0.1	5.1±0.1	1.55±0.05

**Precautions for Use**

1. Soldering Condition

1.1 (A) Maximum Body Case Temperature Profile for evaluation of Reflow Profile

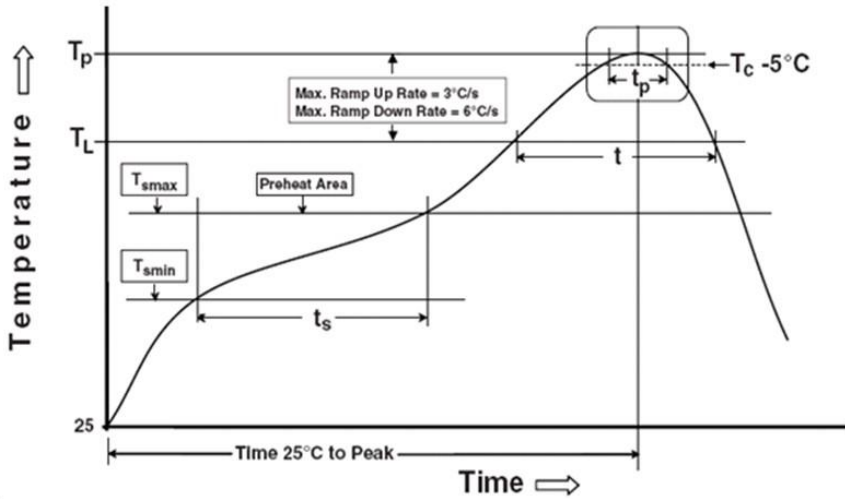

Note:

Reference: IPC/JEDEC J-STD-020D

**Preheat**

Temperature min ( $T_{smin}$ )	150 °C
Temperature max ( $T_{smax}$ )	200°C
Time ( $T_{smin}$ to $T_{smax}$ ) ( $t_s$ )	60-120 seconds
Average ramp-up rate ( $T_{smax}$ to $T_p$ )	3 °C/second max

**Other**

Liquidus Temperature ( $T_L$ )	217 °C
Time above Liquidus Temperature ( $t_L$ )	60-100 sec
Peak Temperature ( $T_p$ )	260°C
Time within 5 °C of Actual Peak Temperature: $T_p - 5^\circ\text{C}$	30 s
Ramp- Down Rate from Peak Temperature	6°C /second max.
Time 25°C to peak temperature	8 minutes max.
Reflow times	3 times

## **DISCLAIMER**

1. Above specification may be changed without notice. EVERLIGHT will reserve authority on material change for above specification.
2. When using this product, please observe the absolute maximum ratings and the instructions for using outlined in these specification sheets. EVERLIGHT assumes no responsibility for any damage resulting from use of the product which does not comply with the absolute maximum ratings and the instructions included in these specification sheets.
3. These specification sheets include materials protected under copyright of EVERLIGHT corporation. Please don't reproduce or cause anyone to reproduce them without EVERLIGHT's consent.

Компания «Life Electronics» занимается поставками электронных компонентов импортного и отечественного производства от производителей и со складов крупных дистрибьюторов Европы, Америки и Азии.

С конца 2013 года компания активно расширяет линейку поставок компонентов по направлению коаксиальный кабель, кварцевые генераторы и конденсаторы (керамические, пленочные, электролитические), за счёт заключения дистрибьюторских договоров

Мы предлагаем:

- Конкурентоспособные цены и скидки постоянным клиентам.
- Специальные условия для постоянных клиентов.
- Подбор аналогов.
- Поставку компонентов в любых объемах, удовлетворяющих вашим потребностям.
- Приемлемые сроки поставки, возможна ускоренная поставка.
- Доставку товара в любую точку России и стран СНГ.
- Комплексную поставку.
- Работу по проектам и поставку образцов.
- Формирование склада под заказчика.
- Сертификаты соответствия на поставляемую продукцию (по желанию клиента).
- Тестирование поставляемой продукции.
- Поставку компонентов, требующих военную и космическую приемку.
- Входной контроль качества.
- Наличие сертификата ISO.

В составе нашей компании организован Конструкторский отдел, призванный помогать разработчикам, и инженерам.

Конструкторский отдел помогает осуществить:

- Регистрацию проекта у производителя компонентов.
- Техническую поддержку проекта.
- Защиту от снятия компонента с производства.
- Оценку стоимости проекта по компонентам.
- Изготовление тестовой платы монтаж и пусконаладочные работы.



Тел: +7 (812) 336 43 04 (многоканальный)  
Email: [org@lifeelectronics.ru](mailto:org@lifeelectronics.ru)