

Heavy Duty Pressure Transducers

PX3 Series, 1 bar to 50 bar | 15 psi to 700 psi

32313757
Issue E

Datasheet



DESCRIPTION

Honeywell's PX3 Series Heavy Duty Pressure Transducers use piezoresistive sensing technology with ASIC (Application Specific Integrated Circuit) signal conditioning in a brass housing and Metri-Pack 150, DIN, or cable harness electrical connections. The PX3 Series is calibrated and temperature compensated from -40°C to 125°C [-40°F to 257°F].

VALUE TO CUSTOMERS

- Total Error Band (TEB) $\pm 1.0\%$ FSS from -20°C to 85°C: Provides indication of the sensor's true measurement performance over a specified temperature range; small error promotes system uptime and efficiency. (See Figure 1.)

Figure 1. TEB Definition and Temperature Performance



- Higher insulation resistance and dielectric strength: Protects the user and sensor in high over-voltage situations, and ensures that the device is compliant with industry standards.
- Higher EMC performance: Operates more reliably in the presence of electro-magnetic fields, such as near wireless signals, RF communication, and electrical devices.
- Higher external freeze/thaw resistance: Survives exposure to frost, commonly found in refrigeration systems. (See Figure 2.)

Figure 2. PX3 Series External Freeze/Thaw Resistance



- Reduced current consumption: Helps to reduce energy costs, and enhances product life if used in battery driven systems.
- Media compatibility: Common HFC (hydrofluorocarbon) refrigerants (R410A and R134A), next generation low global warming potential (GWP) refrigerants (R448A/Solstice® N40, R32 and R1234ZE), engine oil, petroleum-based hydraulic fluids, brake fluids (DOT3), and dry air. For ammonia and other corrosive media, see Honeywell's SPT Series.

DIFFERENTIATION

- Optional diagnostics mode: Beneficial in applications where the sensor functionality and the need to know internal or external failure modes is critical.
- Great customer value: Multiple configuration possibilities provide flexibility of use in the application with no upfront NRE or tooling charges.
- Durable: Provides the tough environmental specifications needed, including insulation resistance and dielectric strength, external freeze-thaw resistance (see Figure 2), and EMC performance.
- 4 mA to 20 mA output is temperature compensated up to 125°C.

FEATURES

- Pressure range: 1 bar to 50 bar | 15 psi to 700 psi (absolute and sealed gage)
- Ratiometric output: 0.5 Vdc to 4.5 Vdc or 0.33 Vdc to 2.97 Vdc
- 4 mA to 20 mA output supports transmission of output signals over longer distances
- Calibrated and temperature compensated
- Total Error Band: $\pm 1.0\%$ FSS from -20°C to 85°C [-4°F to 185°F]
- External freeze/thaw resistance: 6 cycles from -30°C to 50°C [-22°F to 122°F]
- Insulation resistance: >100 MOhm, 1500 Vdc (in dry, non-ionized air)
- Dielectric strength: AC1500V, 1 min. or AC1800V, 1 s (in dry, non-ionized air)
- Current consumption: 3.5 mA max.
- EMC (radiated immunity): 200 V/m (ratiometric voltage output), 140 V/m (current output) per ISO 11452-2
- Ingress protection IP67 (Metri-Pack connector), IP69K (cable harness), IP65 (DIN connector)
- RoHS, REACH, and CE compliant
- Six industry-standard pressure port types, including a tube port which provides for hermetically-sealed process connection

POTENTIAL APPLICATIONS

- Industrial: Refrigerant pressure monitoring in HVAC/R systems; dry air system pressure, process controls and automation
- Transportation: Dry air system monitoring; hydraulic, brake, and engine oil fluid pressure monitoring; air brake pressure monitoring

The PX3 Series is not recommended for use with media involving water, saturated air such as steam and vapor, and ammonia.

PORTFOLIO

Honeywell's PX3 Series joins the PX2 Series, MLH Series, and SPT Series heavy duty pressure transducers.

Heavy Duty Pressure Transducers

PX3 Series, 1 bar to 50 bar | 15 psi to 700 psi

Table 1. Electrical Specifications

Characteristic	Parameter
Supply voltage: ratiometric voltage output: 5 Vdc 3.3 Vdc current output: -40°C to 100°C >100°C to 125°C	5 Vdc ±0.25 Vdc 3 Vdc ±0.25 Vdc 8 Vdc to 30 Vdc 8 Vdc to 25 Vdc
Over voltage and reverse voltage: ratiometric voltage output current output	±16 Vdc ±35 Vdc
Current consumption: 5 Vdc supply 3.3 Vdc supply	3.0 mA max. 1.6 mA to 2.1 mA
Short circuit protection	yes
Nominal output transfer function: 5 Vdc supply 3.3 Vdc supply 8 Vdc to 30 Vdc supply	0.5 Vdc to 4.5 Vdc (ratiometric to supply) 0.33 Vdc to 2.97 Vdc (ratiometric to supply) 4 mA to 20 mA

Table 2. Performance Specifications (At 25°C [77°F] and under unless otherwise noted.)

Characteristic	Parameter
Operating temperature range ¹	-40°C to 125°C [-40°F to 257°F]
Storage temperature range ¹	-40°C to 125°C [-40°F to 257°F]
Compensated temperature range	-40°C to 125°C [-40°F to 257°F]
Total Error Band ² : -20°C to 85°C [-4°F to 185°F] <-20°C, >85°C [<-4°F, >185°F]	±1.0 %FSS ±2.0 %FSS
Accuracy BFSL ³	±0.25 %FSS
Response time	<2 ms (10% to 90% step change in pressure)
Turn on time ⁴	<7 ms
EMC rating ⁵ : surge immunity (all leads) electrostatic discharge radiated immunity fast transient burst immunity to conducted disturbances radiated emissions radiated immunity: ratiometric (voltage) output 4 mA to 20 mA (current) output	±1000 V line to ground per IEC 61000-4-5 ±4 kV contact, ±8 kV air per IEC 61000-4-2 10 V/m (80 MHz to 1000 MHz) per IEC 61000-4-3 ±1 kV per IEC 61000-4-4 3 V per IEC 61000-4-6 40 dBµV (30 MHz to 230 MHz), 47 dBµV (230 MHz to 1000 MHz) per CISPR 11 200 V/m per ISO 11452-2 140 V/m per ISO 11452-2
Insulation resistance ⁶ : ratiometric voltage output current output	>100 MOhm at 1500 Vdc >100 MOhm at 1000 Vdc
Dielectric strength	<1 mA at 1500 Vac (1 min) or 1800 Vac (1 s)
Load resistance ⁶ : ratiometric voltage output current output	>5 kOhm (V _{in} - 8) x 50 Ohm
Life	>10 million full scale pressure cycles over the calibrated pressure range

¹ Dependent on seal material. See Figure 5.

² Total Error Band: The maximum deviation from the ideal transfer function over the entire compensated temperature and pressure range. Includes all errors due to offset, full scale span, pressure non-linearity, pressure hysteresis, pressure non-repeatability, thermal effect on offset, thermal effect on span, and thermal hysteresis.

³ Accuracy: The maximum deviation in output from a Best Fit Straight Line (BFSL) fitted to the output measured over the pressure range at 25°C [77°F]. Includes all errors due to pressure non-linearity, pressure hysteresis, and pressure non-repeatability.

⁴ Turn on time: Duration from power applied until first valid output for voltage output. Typical value for 4 mA to 20 mA output.

⁵ Tested using 1.5 m [59.1 in] long cable.

⁶ Tested in dry, non-ionized air.

Heavy Duty Pressure Transducers

PX3 Series, 1 bar to 50 bar | 15 psi to 700 psi

Table 3. Pressure Reference Definitions

Pressure Reference	Definition
Absolute	Output is calibrated to be proportional to the difference between applied pressure and a fixed reference to perfect vacuum (absolute zero pressure).
Sealed gage ¹	Sensor construction is identical to the absolute version with a built in reference at zero pressure in order to minimize measurement error over temperature. The output is calibrated to be proportional to the difference between applied pressure and a reference of 1 standard atmosphere (1.013 barA 14.7 psiA). Example: 100 psi sealed gage has a calibrated pressure range from 14.7 psi absolute to 114.7 psi absolute. (See Figure 3.)

¹ Sealed gage option only available in pressure ranges at or above 8 bar | 100 psi.

Figure 3. Ratiometric Output Option AA for 100 psi, Absolute vs Sealed Gage



Table 4. Pressure Ratings

bar			psi		
Operating Pressure	Over-pressure	Burst Pressure	Operating Pressure	Over-pressure	Burst Pressure
1	5	8	15	70	115
1.6	5	8	30	150	250
2	10	17	50	250	400
2.5	10	17	100	450	750
4	17	27	150	450	750
6	31	51	174	450	750
8	31	51	200	450	1150
10	31	51	250	450	1150
12	31	51	300	1000	1500
16	32	80	500	1000	1500
20	69	103	600	1000	1500
25	69	103	667	1000	1500
30	69	103	700	1000	1500
35	69	103	-	-	-
40	69	103	-	-	-
46	69	103	-	-	-
50	69	103	-	-	-

Diagnostics Mode (For Ratiometric Voltage Output Only)

The PX3 Series diagnostics mode allows the device to indicate when internal or external faults occur. If an internal fault occurs, the output will rail to the preset lower or upper limit values shown in Figure 4 and Table 5.

External faults will result in the sensor's output exceeding those preset limits (lower or upper). (For example, if the external sensor ground (signal) were lost, the sensor output would exceed the upper rail of 97.5%.)

Figure 4. Analog Output with Diagnostics



Table 5. Output Transfer Function Codes

Fault Condition	Analog Diagnostic Rail
EEPROM Corrupt	below lower rail
Sensor Bridge Open (any element)	above upper rail
Sensor Bridge Short (any element)	above upper rail
Low supply voltage	below lower rail
Loss of ground connection	above upper rail

Heavy Duty Pressure Transducers

PX3 Series, 1 bar to 50 bar | 15 psi to 700 psi

Table 6. Environmental and Mechanical Specifications

Characteristic	Parameter
Shock: threaded ports tube port	100 G per MIL-STD-202G, Method 213B, Cond. F (at 25°C [77°F]) 100 G per MIL-STD-202F, Method 213B, and Condition C
Vibration: threaded ports tube port	20 G sweep, 10 Hz to 2000 Hz (at 25°C [77°F]) 10 Hz to 55 Hz, 2 mm displacement, tested as per IEC 60068-2-6; Test FC. (at 25°C [77°F])
Ingress protection: Metri-Pack 150 electrical connector DIN electrical connector Cable harness electrical connector	IP67 IP65 IP65, IP67, IP69K
Ambient humidity	0 %RH to 95 %RH, non-condensing
External freeze/thaw resistance	>6 cycles from -30°C to 50°C [-22°F to 122°F]
Wetted materials: threaded ports external seals for ports tube port braze filler internal O-ring media seal sensing element and substrate adhesives	brass C36000; lead (Pb) content: 3.7% max. nitrile copper UNS C12200; lead (Pb) free silver and copper alloy seal material based on application (see seal material media compatibility options below) alumina, glass, silicon epoxy
Internal O-ring material media compatibility ¹ : HNBR (option H) silicone (option S)	refrigerants, engine oil, petroleum-based hydraulic fluid dry air
Electrical connector material	PBT 30% GF

¹Honeywell can assist with selecting suitable O-ring seal material for the media based on the seal manufacturer's recommendation. The customer should test the compatibility with the media to ensure that it is correct for the application.

CAUTION

PRODUCT DAMAGE TO TUBE PRESSURE PORT TYPE DURING BRAZING

Ensure that the temperature of the brass port and plastic connector is maintained below 125°C during flame brazing. Exposure to temperatures higher than 125°C can cause permanent product damage and can compromise ingress protection leading to short circuits.

Failure to comply with these instructions may result in product damage.

CAUTION

PRODUCT DAMAGE DUE TO MECHANICAL ISSUES

- Ensure torque specifications are determined for the specific application. Values provided are for reference only. (Mating materials and thread sealants can result in significantly different torque values from one application to the next.)
- When using mating parts made of stainless steel, use a thread sealant with anti-seize properties to prevent thread galling. Ensure the sealant is rated for the application.
- Use appropriate tools (such as an open ended wrench or deep well socket) to install transducers.
- Always hand-start transducers into the hole to prevent cross threading and damage.
- Ensure that torque is not applied to the electrical connector.
- Ensure that the proper mating electrical connector with a seal is used to connect the transducer. Improper or damaged seals can compromise ingress protection, leading to short circuits.

Failure to comply with these instructions may result in product damage.

CAUTION

PRODUCT DAMAGE DUE TO PARTICULATES AND SATURATED AIR

Ensure that filters and dehumidifiers are used upstream of the transducers to keep media flow free of large particulates and condensed moisture. PX3 Series transducers are dead-end devices. Particulate accumulation may clog the port or damage the diaphragm. Condensing moisture may affect sensor output and lower insulation resistance.

Failure to comply with these instructions may result in product damage.

CAUTION

PRODUCT DAMAGE DUE TO CONDUCTIVE MEDIA

Ensure sensor is not used with conductive or ionic media. These media can affect sensor output and lower insulation resistance.

Failure to comply with these instructions may result in product damage.











Heavy Duty Pressure Transducers

PX3 Series, 1 bar to 50 bar | 15 psi to 700 psi

Figure 5. Nomenclature and Order Guide

For example, **PX3AN1BS150PAAAX** defines a PX3 Series Heavy Duty Pressure Transducer, Metri-Pack 150, standard (UL V-0) electrical connector type, 1/4-18 NPT pressure port type, brass housing body, silicone: -40°C to 125°C [-40°F to 257°F] seal material and temperature range, 150 psi pressure range, absolute pressure reference, ratiometric: 0.5 Vdc to 4.5 Vdc output transfer function, no special

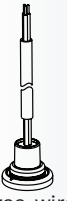
PX3 A N1 B S 150P A A X

Series PX3 Heavy Duty Pressure Transducer ¹			Special X
Electrical Connector Type			Output Transfer Function
A Metri-Pack 150, Standard (UL V-0) ²		AA Ratiometric: 5.0 V, 10% to 90% Vs	
C DIN (Male, EN 175301-803C)		DA Ratiometric: 5.0 V, 10% to 90% Vs (diagnostics on) ⁶	
		AC Ratiometric: 3.3 V, 10% to 90% Vs	
		DC Ratiometric: 3.3 V, 10% to 90% Vs (diagnostics on) ⁶	
		CH Current: 4 mA to 20 mA	
		Pressure Reference	
		A Absolute	
		S Sealed gage ⁷	
		Pressure Range	
		bar	
		psi	
		001B 1 bar	016B 16 bar
		1.6B 1.6 bar	020B 20 bar
		002B 2 bar	025B 25 bar
		2.5B 2.5 bar	030B 30 bar
		004B 4 bar	035B 35 bar
		006B 6 bar	040B 40 bar
		008B 8 bar	046B 46 bar
		010B 10 bar	050B 50 bar
		012B 12 bar	
		015P 15 psi	250P 250 psi
		030P 30 psi	300P 300 psi
		050P 50 psi	500P 500 psi
		100P 100 psi	600P 600 psi
		150P 150 psi	667P 667 psi
		174P 174 psi	700P 700 psi
		200P 200 psi	
		Internal O-ring Material and Temperature Range ^{1,8}	
		H HNBR (Hydrogenated Nitrile Butadiene Rubber): -30°C to 125°C [-22°F to 257°F]	
		S Silicone: -40°C to 125°C [-40°F to 257°F]	
		Housing Body Material	
		B Brass (C36000)	
		Pressure Port Type ⁴	
		F1 7/16-20 UNF 1/4 inch 45° Flare Female Schrader (SAE J512)	
		G1 G1/4 A-G (ISO 1179-3)	
		G2 G1/4 A-L (ISO 1179-2)	
		M1 M12 x 1.5 (ISO 6149-3)	
		N1 1/4-18 NPT (ANSI/ASME B1.20.1)	
		N2 1/8-27 NPT (ANSI/ASME B1.20.1)	
		T1 Tube ⁵	
		Pressure Cable	
		PVC Cable ³ -40°C to 105°C [-40°F to 221°F] two or three 22 AWG wires	
		XLPE Cable ³ -40°C to 125°C [-40°F to 257°F] two or three 22 AWG wires	
		Three-wire  two-wire 	
		Three-wire cable is required for ratiometric Output Transfer Functions AA , DA , AC and DC ; two-wire cable is required for Output Transfer Function CH .	
		Three meter and five meter cables are only available with Output Transfer Function CH .	
		Mating Connector ²	
			

¹ Not all catalog listing combinations are shown. Custom configurations, such as varied cable lengths, end mating connectors, different O-ring materials, and different pressure ranges are available. Please contact Honeywell.

² Metri-Pack 150 mating connectors with shielded cable and three 22 AWG wires are available from Honeywell. Order part no. 3685301 for 1 m [3.2 ft] cable length and part no. 3685302 for 3 m [9.8 ft] cable length.

³ PVC Flame Retardant (FR) type cable is FT1 rated per IEC60332-1; XLPE non-flame retardant cable is FT2 rated per IEC60332-1.

⁴ See Table for pressure port materials.

⁵ Tube port is not available with DIN connector option.

⁶ See page 3 for Diagnostics Mode information.

⁷ Sealed gage option only available in pressure ranges at or above 8 bar | 100 psi.

⁸ See Table 6 for O-ring seal material media compatibility.

Heavy Duty Pressure Transducers

PX3 Series, 1 bar to 50 bar | 15 psi to 700 psi

Figure 6. Metri-Pack Mounting Dimensions (For reference only. mm/[in].)



F1: 7/16-20 UNF 1/4 inch 45° Flare Female Schrader (SAE J512)

Seal: 45° cone
 Mating geometry: SAE J512
 Installation torque: 17 N m [12.5 ft-lb]
 Weight: 41 g to 46 g [1.4 oz to 1.6 oz]



G1: G1/4 A-G (ISO 1179-3)

Seal: O-ring (included)
 Mating geometry: ISO 1179-1
 Installation torque: 50 N m [36.9 ft-lb]
 Weight: 35.1 g to 40.1 g [1.2 oz to 1.4 oz]



G2: G1/4 A-L (ISO 1179-2)

Seal: ISO 9974-2/DIN 3869 profile ring (included)
 Mating geometry: ISO 1179-1
 Installation torque: 50 N m [36.9 ft-lb]
 Weight: 35.1 g to 40.1 g [1.2 oz to 1.4 oz]

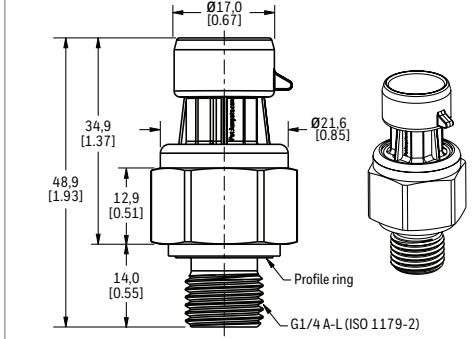

M1: M12 x 1.5 (ISO 6149-3)

Seal: O-ring (included)
 Mating geometry: ISO 6149-1
 Installation torque: 25 N m [18.4 ft-lb]
 Weight: 33.9 g to 38.9 g [1.2 oz to 1.4 oz]



N1: 1/4-18 NPT

Seal: Pipe thread
 Mating geometry: ANSI B1.20.1
 Installation torque: Two to three turns from finger tight
 Weight: 35.1 g to 40.1 g [1.2 oz to 1.4 oz]



N2: 1/8-27 NPT

Seal: Pipe thread
 Mating geometry: ANSI B1.20.1
 Installation torque: Two to three turns from finger tight
 Weight: 31.2 g to 36.2 g [1.1 oz to 1.3 oz]



T1: Tube

Seal: Brazing
 Weight: 32 g [1.1 oz]



Heavy Duty Pressure Transducers

PX3 Series, 1 bar to 50 bar | 15 psi to 700 psi

Figure 7. DIN Mounting Dimensions (For reference only. mm/[in.])

Pinout



General product marking



F1: 7/16-20 UNF 1/4 inch 45° Flare Female Schrader (SAE J512)

Seal: 45° cone
Mating geometry: SAE J512
Installation torque: 17 N m [12.5 ft-lb]
Weight: 42 g to 47 g [1.5 oz to 1.7 oz]



G1: G1/4 A-G (ISO 1179-3)

Seal: O-ring (included)
Mating geometry: ISO 1179-1
Installation torque: 50 N m [36.9 ft-lb]
Weight: 36.1 g to 41.1 g [1.3 oz to 1.4 oz]



G2: G1/4 A-L (ISO 1179-2)

Seal: ISO 9974-2/DIN 3869 profile ring (included)
Mating geometry: ISO 1179-1
Installation torque: 50 N m [36.9 ft-lb]
Weight: 36.1 g to 41.1 g [1.3 oz to 1.4 oz]



M1: M12 x 1.5 (ISO 6149-3)

Seal: O-ring (included)
Mating geometry: ISO 6149-1
Installation torque: 25 N m [18.4 ft-lb]
Weight: 34.9 g to 39.9 g [1.2 oz to 1.4 oz]



N1: 1/4-18 NPT

Seal: Pipe thread
Mating geometry: ANSI B1.20.1
Installation torque: Two to three turns from finger tight
Weight: 36.1 g to 41.1 g [1.3 oz to 1.4 oz]



N2: 1/8-27 NPT

Seal: Pipe thread
Mating geometry: ANSI B1.20.1
Installation torque: Two to three turns from finger tight
Weight: 32.2 g to 37.2 g [1.1 oz to 1.3 oz]



Heavy Duty Pressure Transducers

PX3 Series, 1 bar to 50 bar | 15 psi to 700 psi

Figure 8. Cable Harness Mounting Dimensions (For reference only. mm/[in].)



F1: 7/16-20 UNF 1/4 inch 45° Flare Female Schrader (SAE J512)

Seal: 45° cone
 Mating geometry: SAE J512
 Installation torque: 17 N m [12.5 ft-lb]
 Weight: 90 g to 88 g [3.2 oz to 3.1 oz]



G1: G1/4 A-G (ISO 1179-3)

Seal: O-ring (included)
 Mating geometry: ISO 1179-1
 Installation torque: 50 N m [36.9 ft-lb]
 Weight: 70 g to 68 g [2.5 to 2.4 oz]



G2: G1/4 A-L (ISO 1179-2)

Seal: ISO 9974-2/DIN 3869 profile ring (included)
 Mating geometry: ISO 1179-1
 Installation torque: 50 N m [36.9 ft-lb]
 Weight: 70 g to 68 g [2.5 oz to 2.4 oz]



M1: M12 x 1.5 (ISO 6149-3)

Seal: O-ring (included)
 Mating geometry: ISO 6149-1
 Installation torque: 25 N m [18.4 ft-lb]
 Weight: 69 g to 67 g [2.4 oz]



Heavy Duty Pressure Transducers

PX3 Series, 1 bar to 50 bar | 15 psi to 700 psi

Figure 8. Cable Harness Mounting Dimensions (For reference only. mm/[in].)

N1: 1/4-18 NPT

Seal: Pipe thread

Mating geometry: ANSI B1.20.1

Installation torque: Two to three turns from finger tight

Weight: 70 g to 68 g [2.5 oz to 2.4 oz]



N2: 1/8-27 NPT

Seal: Pipe thread

Mating geometry: ANSI B1.20.1

Installation torque: Two to three turns from finger tight

Weight: 66 g to 64 g [2.3 oz]



T1: Tube

Seal: Brazing

Weight: 67 g [2.4 oz]



ADDITIONAL INFORMATION

The following associated literature is available on the Honeywell web site at sensing.honeywell.com:

- Product line guide
- Product range guide
- Product installation instructions
- Application notes:
 - Heavy Duty Pressure Transducers, PX2 Series and PX3 Series
 - PX2 Series and PX3 Series Heavy Duty Pressure Transducers for Potential Use in Industrial Refrigeration
 - PX2 Series and PX3 Series Heavy Duty Pressure Transducers for Potential Use in Industrial HVAC/R Applications
- Technical notes:
 - Total Error Band Specification for Honeywell Heavy Duty Pressure Transducers, PX2 Series and PX3 Series
 - Media Compatibility for Honeywell Heavy Duty Pressure Transducers, PX2 Series and PX3 Series
- CAD models

For more information

Honeywell Sensing and Internet of Things services its customers through a worldwide network of sales offices and distributors. For application assistance, current specifications, pricing or the nearest Authorized Distributor, visit sensing.honeywell.com or call:

Asia Pacific +65 6355-2828
Europe +44 (0) 1698 481481
USA/Canada +1-800-537-6945

Solstice® N40 is a registered trademark of Honeywell International Inc.

Honeywell Sensing and Internet of Things

9680 Old Bailes Road
Fort Mill, SC 29707
www.honeywell.com

32313757-E-EN | E | 01/18
© 2018 Honeywell International Inc.

⚠ WARNING **PERSONAL INJURY**

DO NOT USE these products as safety or emergency stop devices or in any other application where failure of the product could result in personal injury.

Failure to comply with these instructions could result in death or serious injury.

⚠ WARNING **MISUSE OF DOCUMENTATION**

- The information presented in this datasheet is for reference only. Do not use this document as a product installation guide.
- Complete installation, operation, and maintenance information is provided in the instructions supplied with each product.

Failure to comply with these instructions could result in death or serious injury.

Warranty/Remedy

Honeywell warrants goods of its manufacture as being free of defective materials and faulty workmanship during the applicable warranty period. Honeywell's standard product warranty applies unless agreed to otherwise by Honeywell in writing; please refer to your order acknowledgement or consult your local sales office for specific warranty details. If warranted goods are returned to Honeywell during the period of coverage, Honeywell will repair or replace, at its option, without charge those items that Honeywell, in its sole discretion, finds defective. **The foregoing is buyer's sole remedy and is in lieu of all other warranties, expressed or implied, including those of merchantability and fitness for a particular purpose. In no event shall Honeywell be liable for consequential, special, or indirect damages.**

While Honeywell may provide application assistance personally, through our literature and the Honeywell web site, it is buyer's sole responsibility to determine the suitability of the product in the application.

Specifications may change without notice. The information we supply is believed to be accurate and reliable as of this writing. However, Honeywell assumes no responsibility for its use.

Honeywell

Компания «Life Electronics» занимается поставками электронных компонентов импортного и отечественного производства от производителей и со складов крупных дистрибьюторов Европы, Америки и Азии.

С конца 2013 года компания активно расширяет линейку поставок компонентов по направлению коаксиальный кабель, кварцевые генераторы и конденсаторы (керамические, пленочные, электролитические), за счёт заключения дистрибьюторских договоров

Мы предлагаем:

- Конкурентоспособные цены и скидки постоянным клиентам.
- Специальные условия для постоянных клиентов.
- Подбор аналогов.
- Поставку компонентов в любых объемах, удовлетворяющих вашим потребностям.
- Приемлемые сроки поставки, возможна ускоренная поставка.
- Доставку товара в любую точку России и стран СНГ.
- Комплексную поставку.
- Работу по проектам и поставку образцов.
- Формирование склада под заказчика.
- Сертификаты соответствия на поставляемую продукцию (по желанию клиента).
- Тестирование поставляемой продукции.
- Поставку компонентов, требующих военную и космическую приемку.
- Входной контроль качества.
- Наличие сертификата ISO.

В составе нашей компании организован Конструкторский отдел, призванный помогать разработчикам, и инженерам.

Конструкторский отдел помогает осуществить:

- Регистрацию проекта у производителя компонентов.
- Техническую поддержку проекта.
- Защиту от снятия компонента с производства.
- Оценку стоимости проекта по компонентам.
- Изготовление тестовой платы монтаж и пусконаладочные работы.



Тел: +7 (812) 336 43 04 (многоканальный)
Email: org@lifeelectronics.ru