









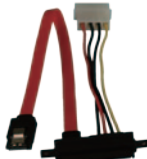

Cables and Connectors *FDD / HDD cable*

SATA HDD cable			
			
Model Name	32000-062800-RS	32102-000100-100-RS	32000-080700-RS
Cable type	SATA HDD cable	SATA power cable	SATA + Power cable
Connector	SATA 7-pin	4-pin model + 2 x SATA 15-pin	SATA 7-pin + 4-pin model
Connector type	Lockable	SATA power connector	
Length	50 cm	15 cm	SATA cable 20 cm Power cable 10 cm

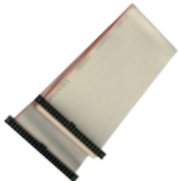

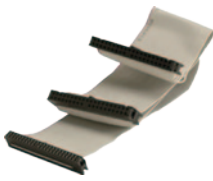

SATA HDD cable		IDE HDD cable	
			
Model Name	32801-000201-100-RS	32801-000100-100-RS	32200-000009-RS
Cable type	SATA + Power cable	SATA + Power cable	IDE HDD flat cable
Connector	SATA 7-pin + 2-pin wafer 2.0mm	SATA 7-pin + 4-pin wafer 2.54mm	44p-44p
Connector type	2-pin PH 2.0	4-pin PH 2.54 mm	2.0mm -2.0mm
Length	SATA cable 15 cm Power cable 15 cm	SATA cable 20 cm Power cable 20 cm	40 cm





IDE HDD cable			
			
Model Name	32221-001000-101-RS	32200-025001-RS	32225-002000-100-RS
Cable type	IDE HDD flat cable	IDE HDD flat cable	ATA-66 HDD flat cable
Connector	44p-44p	44p-40p-40p	40p-40p-40p
Connector type	2.0mm -2.0mm	2.0mm-2.54mm-2.54mm	2.54mm
Length	25 cm	20 cm + 15 cm	30 cm + 15 cm







IDE HDD cable			
			
Model Name	32221-001700-100-RS	CB-HD32-RS	CVT-4044-RS
Cable type	ATA-33 HDD flat cable	IDE HDD flat cable	IDE adapter
Connector	44p-40p-40p	40p-44p	40p-44p
Connector type	2.0mm-2.54mm-2.54mm	2.54mm-2.0mm	2.54mm-2.0mm
Length	20 cm + 15 cm	IDE cable: 39 cm Power cable: 20 cm	Power cable: 20 cm





Part numbers listed in the product catalog are for reference purposes. IEI reserves the right to implement substitution parts when the function is not affected.

Cables and Connectors *Paralle / Serial cable*

	Serial cable				
					
Model Name	45002-008103-RS	19800-000300-100-RS	19800-000114-RS	19800-000051-RS	19800-003600-100-RS
Cable type	Serial port	Serial port cable	Serial port cable	Serial port cable	Serial port cable
Board side	N/A	10-pin (2x5) connector (2.0 mm)	10-pin (2x5) connector (2.54 mm)	2 x 10-pin (2x5) connector (2.54 mm)	2 x 10-pin (2x5) connector (2.54mm)
Board side pitch	2.54 mm	2.0 mm	2.54 mm	2.54 mm	2.54 mm
Device side	2 x DE9M	DE9M	DE9M	2 x DE9M	2 x DE9M
Bracket	Yes	Yes	Yes	Yes	Yes
Length	9 CM	30 cm	50 cm	23 cm	40 cm





	Serial cable				
					
Model Name	19800-000112-RS	32205-000702-100-RS	32200-000049-RS	32205-001203-100-RS	32205-002000-100-RS
Cable type	Serial port cable	Serial port cable	Serial port cable	Serial port cable	Serial port cable
Board side	2 x 10-pin (2x5) connector (2.0 mm)	10-pin (2x5) connector (2.54 mm)	10-pin (2x5) connector (2.0 mm)	40-pin (2x20) connector (2.54 mm)	40-pin (2x20) connector (2.0 mm)
Board side pitch	2.0 mm	2.54 mm	2.0 mm	2.54 mm	2.0 mm
Device side	2 x DE9M	DE9M	DE9M	4 x DE9M	4 x DE9M
Bracket	Yes	No	No	No	No
Length	30 cm	23 cm	20 cm	40/40/40/40 cm	30 cm





	Serial cable					
						
Model Name	32205-001800-200-RS	32205-002500-100-RS	19800-004400-100-RS	19800-004300-100-RS	32205-000300-100-RS	32205-003700-100-RS
Cable type	Serial port cable	RS-422/485 cable	RS-232 & RS-422/485 cable	RS-232 & RS-422/485 cable	RS-232 & RS-422/485 cable	RS-232 & RS-422/485 cable
Board side	40-pin (2x20) connector (2.0 mm)	16-pin (2x8) connector (2.54 mm)	14-pin (2x7) connector (2.54 mm)	14-pin (2x7) connector (2.0 mm)	14-pin (2x7) connector (2.0 mm)	14-pin (2x7) connector (2.0 mm)
Board side pitch	2.0 mm	2.54 mm	2.54 mm	2.0 mm	2.0 mm	2.0 mm
Device side	4 x DE9M	4 x DE9M	2 x DE9M	2 x DE9M	2 x DE9M	2 x DE9M
Bracket	No	No	Yes	Yes	No	No
Length	30 cm	12 cm	25.5 cm	25 cm	29 cm	23 cm

	Serial cable	Paralle cable			
					
Model Name	32205-003800-100-RS	19800-000049-RS	19800-000142-00-RS	19800-003500-100-RS	32200-015100-RS
Cable type	RS-422/485 cable	Parallel port cable	Parallel and serial port cable	Parallel and serial port cable	Parallel port cable
Board side	4-pin (1x4) connector (2.0 mm)	26-pin (2x13) connector (2.54 mm)	26-pin (2x13) connector (2.54 mm) 10-pin (2x5) connector (2.54 mm)	26-pin (2x13) connector (2.0 mm) 10-pin (2x5) connector (2.0 mm)	26-pin (2x13) connector (2.0 mm)
Board side pitch	2.0 mm	2.54 mm	2.54 mm	2.0 mm	2.0 mm
Device side	DE9M	DB25F	DB25F + DE9M	DB25F + DE9M	DB25F
Bracket	No	Yes	Yes	Yes	No
Length	20 cm	24 cm	24 cm	24 cm	28 cm



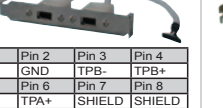

Part numbers listed in the product catalog are for reference purposes. IEI reserves the right to implement substitution parts when the function is not affected.





Cables and Connectors *USB / 1394 / Y Cable*

	USB cable				
					
Model Name	32001-010800-100-RS	32001-006404-100-RS	19800-000100-200-RS	19800-003100-300-RS	19800-003000-200-RS
Cable type	USB cable	USB cable	USB cable	USB cable	USB cable
Board side	2 x 4pin connector (2.0mm)	2 x 4pin connector (2.0mm)	2 x 4-pin (2x4) connector (2.54mm)	2 x 4-pin (1x4) connector (2.54mm)	1 x 8-pin (2x4) connector (2.0mm)
Board side pitch	2.54mm	2.00mm	2.54mm	2.54mm	2.0mm
Device side	2 x USB	2 x USB	4 x USB	2 x USB	2 x USB
Bracket	No	No	Yes	Yes	Yes
Length	20cm	22cm	30 cm	30 cm	30 cm

	USB cable			1394 cable	
					
Model Name	32000-044300-RS	32000-073400-RS	32000-070301-RS	CB-IEEE1394-RS	19800-000103-RS
Cable type	USB cable	USB cable	USB cable	1394 cable	1394 cable
Board side	1 x 8-pin (2x4) connector (2.54mm)	2 x 5-pin connector (2.0mm) for WAFER-8523, WAFER-945GSE3 only	1 x 8-pin (2x4) connector (2.0mm)	2 x 8-pin (1x8) connector (2.0mm)	1 x 8-pin (1x8) connector (2.0mm)
Board side pitch	2.54mm	2.0mm	2.0mm	2.0 mm	2.0 mm
Device side	2 x USB	2 x USB	2 x USB	2 x IEEE1394	1 x IEEE1394
Bracket	No	No	No	Yes	Yes
Length	21 cm	40 cm	21 cm	21 cm	25 cm



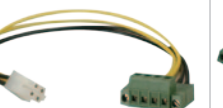

Pin 1	Pin 2	Pin 3	Pin 4
+12V	GND	TPB-	TPB+
Pin 5	Pin 6	Pin 7	Pin 8
TPA-	TPA+	SHIELD	SHIELD





	Keyboard / Mouse cable				
					
Model Name	19800-000066-RS	19800-000075-RS	32006-000300-100-RS	32000-043301-RS	32006-001100-100-RS
Cable type	Keyboard and mouse cable	Y-Cable	Y-Cable	Y-Cable	Y-Cable
Board side	2 x 5-pin (1x5) connector (2.54mm)	1 x 6-pin (1x6) connector (2.0mm)	1 x male PS/2	1 x 6-pin (1x6) connector (2.54mm)	1 x 6-pin (1x6) connector (2.0mm)
Board side pitch	2.54mm	2.0mm		2.54mm	2.0mm
Device side	2 x Female PS/2	2 x Female PS/2	2 x Female PS/2	2 x Female PS/2	2 x Female PS/2
Bracket	Yes	Yes	No	No	No
Length	30 cm	22 cm	12 cm (KB) + 14 (MS)	60 cm	13 cm

	Power cable				
					
Model Name	32100-087100-RS	32102-022100-100-RS	32102-005100-200-RS	32100-192900-RS	32100-130300-RS
Cable type	12V power cable	ATX function cable	12V power cable	12V power cable	Power cable for PC/104 CPU module
Board side	1 x 4-pin (2x2) connector	1 x 20-pin ATX power connector	1 x 4-pin (2x2) connector	1 x 4-pin (2x2) connector	1 x 4-pin (1x4) molex
Device side	2 x 4-pin (1x4) molex	1 x 4-pin (1x4) molex 1 x 3-pin PS_ON connector	with lock screw	4-pin 3.5 mm terminal block	3-pin 3.5 mm terminal block
Bracket	No	No	No	No	No
Length	13 cm	30 cm	25cm	25 cm	10 cm

Part numbers listed in the product catalog are for reference purposes. IEI reserves the right to implement substitution parts when the function is not affected.

Cables and Connectors *Audio / LAN / VGA / Adapter Cable*

	Audio cable				
					
Model Name	19800-000043-RS	19800-000800-100-RS	19800-000111-RS	32207-000100-100-RS	32007-002700-100-RS
Cable type	Audio and Serial cable	Audio cable	Audio cable	Audio cable	Audio cable
Board side	Audio cable : 4-pin (1x4) connector (2.54mm) Serial cable : 10-pin (2x5) connector (2.0mm)	12-pin (2x6) connector (2.0mm)	10-pin (2x5) connector (2.0mm)	10-pin (2x5) connector (2.54 mm)	16-pin (2x8) connector (2.0mm)
Board side pitch	Audio : 2.54mm Serial cable : 2.0mm	2.0mm	2.0mm	2.54 mm	2.0mm
Device side	2 x Audio jacks / 1 x DE9M	4 x Audio jacks	3 x Audio jacks	10-pin (2x5) dupon	3 x Audio jacks
Bracket	Yes	Yes	Yes	No	No
Length	30 cm	25 cm	30 cm	40 cm	25 cm



	Audio cable	LAN cable	VGA cable		
					
Model Name	32007-002600-100-RS	32000-028800-RS	32013-001700-100-RS	32003-000800-100-RS	32003-000900-100-RS
Cable type	Audio cable	Audio cable	LAN cable	VGA cable	VGA cable
Board side	10-pin (2x5) connector (2.0mm)	12-pin (2x6) connector (2.54mm)	10-pin (2x5) connector (2.0mm)	10-pin (2x5) connector (2.54mm)	10-pin (2x5) connector (2.0mm)
Board side pitch	2.0mm	2.54mm	2.0mm	2.54mm	2.0mm
Device side	3 x Audio jacks	4 x Audio jacks	1 x RJ-45	1 x DB15F	1 x DB15F
Bracket	No	No	No	No	No
Length	30 cm	25 cm	31 cm	30 cm	30 cm

Part numbers listed in the product catalog are for reference purposes. IEI reserves the right to implement substitution parts when the function is not affected.

Rackmount Slide *Chassis optional Accessories*

	SLIDE		
			
Model Name	SLIDE-18	SLIDE-24	EXTENDER-6
Specification	18" rackmount slide	24" rackmount slide	6" extender
Description	For rackmount chassis w/ depth up to 500	For rackmount chassis w/ depth up to 500	For 18" or 24" slider

DIN Rail Kit

	KIT	
		
Model Name	DK-100-R10	DK-84MB
Specification	110(W) X 100(D) mm	168(W) X 96(D) mm
Description	VESA 100 to DIN-Rail kit	DIN mount kit for ECW-281 series, black, RoHS

Компания «Life Electronics» занимается поставками электронных компонентов импортного и отечественного производства от производителей и со складов крупных дистрибьюторов Европы, Америки и Азии.

С конца 2013 года компания активно расширяет линейку поставок компонентов по направлению коаксиальный кабель, кварцевые генераторы и конденсаторы (керамические, пленочные, электролитические), за счёт заключения дистрибьюторских договоров

Мы предлагаем:

- Конкуренспособные цены и скидки постоянным клиентам.
- Специальные условия для постоянных клиентов.
- Подбор аналогов.
- Поставку компонентов в любых объемах, удовлетворяющих вашим потребностям.
- Приемлемые сроки поставки, возможна ускоренная поставка.
- Доставку товара в любую точку России и стран СНГ.
- Комплексную поставку.
- Работу по проектам и поставку образцов.
- Формирование склада под заказчика.
- Сертификаты соответствия на поставляемую продукцию (по желанию клиента).
- Тестирование поставляемой продукции.
- Поставку компонентов, требующих военную и космическую приемку.
- Входной контроль качества.
- Наличие сертификата ISO.

В составе нашей компании организован Конструкторский отдел, призванный помогать разработчикам, и инженерам.

Конструкторский отдел помогает осуществить:

- Регистрацию проекта у производителя компонентов.
- Техническую поддержку проекта.
- Защиту от снятия компонента с производства.
- Оценку стоимости проекта по компонентам.
- Изготовление тестовой платы монтаж и пусконаладочные работы.



Тел: +7 (812) 336 43 04 (многоканальный)

Email: org@lifeelectronics.ru