

Dual/Quad, 4.5ns, Single Supply 3V/5V Comparators with Rail-to-Rail Outputs

FEATURES

- **UltraFast: 4.5ns at 20mV Overdrive**
7ns at 5mV Overdrive
- **Low Power: 4mA per Comparator**
- Optimized for 3V and 5V Operation
- Pinout Optimized for High Speed Ease of Use
- Input Voltage Range Extends 100mV Below Negative Rail
- TTL/CMOS Compatible Rail-to-Rail Outputs
- Internal Hysteresis with Specified Limits
- Low Dynamic Current Drain; 15 μ A/(V-MHz), Dominated by Load In Most Circuits
- Tiny 3mm \times 3mm \times 0.75mm DFN Package (LT1720)

APPLICATIONS

- High Speed Differential Line Receiver
- Crystal Oscillator Circuits
- Window Comparators
- Threshold Detectors/Discriminators
- Pulse Stretchers
- Zero-Crossing Detectors
- High Speed Sampling Circuits

DESCRIPTION

The LT[®]1720/LT1721 are UltraFast[™] dual/quad comparators optimized for single supply operation, with a supply voltage range of 2.7V to 6V. The input voltage range extends from 100mV below ground to 1.2V below the supply voltage. Internal hysteresis makes the LT1720/LT1721 easy to use even with slow moving input signals. The rail-to-rail outputs directly interface to TTL and CMOS. Alternatively, the symmetric output drive can be harnessed for analog applications or for easy translation to other single supply logic levels.

The LT1720 is available in three 8-pin packages; three pins per comparator plus power and ground. In addition to SO and MSOP packages, a 3mm \times 3mm low profile (0.8mm) dual fine pitch leadless package (DFN) is available for space limited applications. The LT1721 is available in the 16-pin SSOP and S packages.

The pinouts of the LT1720/LT1721 minimize parasitic effects by placing the most sensitive inputs (inverting) away from the outputs, shielded by the power rails. The LT1720/LT1721 are ideal for systems where small size and low power are paramount.

LT, LT, LTC and LTM are registered trademarks of Linear Technology Corporation. UltraFast is a trademark of Linear Technology Corporation. All other trademarks are the property of their respective owners.

TYPICAL APPLICATION

2.7V to 6V Crystal Oscillator with TTL/CMOS Output



Propagation Delay vs Overdrive



17201 TA02

17201fc

ABSOLUTE MAXIMUM RATINGS (Note 1)

Supply Voltage, V_{CC} to GND.....	7V	Storage Temperature Range.....	-65°C to 150°C
Input Current.....	$\pm 10\text{mA}$	(DD Package).....	-65°C to 125°C
Output Current (Continuous)	$\pm 20\text{mA}$	Operating Temperature Range	
Junction Temperature	150°C	C Grade.....	0°C to 70°C
(DD Package).....	125°C	I Grade	-40°C to 85°C
Lead Temperature (Soldering, 10 sec)	300°C		

PIN CONFIGURATION



ORDER INFORMATION

LEAD FREE FINISH	TAPE AND REEL	PART MARKING*	PACKAGE DESCRIPTION	TEMPERATURE RANGE
LT1720CDD#PBF	LT1720CDD#TRPBF	LA AV	8-Lead (3mm × 3mm) Plastic DFN	0°C to 70°C
LT1720IDD#PBF	LT1720IDD#TRPBF	LA AV	8-Lead (3mm × 3mm) Plastic DFN	-40°C to 85°C
LT1720CMS8#PBF	LT1720CMS8#TRPBF	LTDS	8-Lead Plastic MSOP	0°C to 70°C
LT1720IMS8#PBF	LT1720IMS8#TRPBF	LTACW	8-Lead Plastic MSOP	-40°C to 85°C
LT1720CS8#PBF	LT1720CS8#TRPBF	1720	8-Lead Plastic SO	0°C to 70°C
LT1720IS8#PBF	LT1720IS8#TRPBF	1720I	8-Lead Plastic SO	-40°C to 85°C
LT1721CGN#PBF	LT1721CGN#TRPBF	1721	16-Lead Narrow Plastic SSOP	0°C to 70°C
LT1721IGN#PBF	LT1721IGN#TRPBF	1721I	16-Lead Narrow Plastic SSOP	-40°C to 85°C
LT1721CS#PBF	LT1721CS#TRPBF	1721	16-Lead Plastic SO	0°C to 70°C
LT1721IS#PBF	LT1721IS#TRPBF	1721I	16-Lead Plastic SO	-40°C to 85°C

Consult LTC Marketing for parts specified with wider operating temperature ranges. *The temperature grade is identified by a label on the shipping container. Consult LTC Marketing for information on non-standard lead based finish parts.

For more information on lead free part marking, go to: <http://www.linear.com/leadfree/>

For more information on tape and reel specifications, go to: <http://www.linear.com/tapeandreel/>

ELECTRICAL CHARACTERISTICS

The ● denotes specifications that apply over the full operating temperature range, otherwise specifications are at $T_A = 25^\circ\text{C}$. $V_{CC} = 5\text{V}$, $V_{CM} = 1\text{V}$, $C_{OUT} = 10\text{pF}$, $V_{OVERDRIVE} = 20\text{mV}$, unless otherwise specified.

SYMBOL	PARAMETER	CONDITIONS	MIN	TYP	MAX	UNITS
V_{CC}	Supply Voltage		● 2.7		6	V
I_{CC}	Supply Current (Per Comparator)	$V_{CC} = 5\text{V}$ $V_{CC} = 3\text{V}$	●	4	7	mA
			●	3.5	6	mA
V_{CMR}	Common Mode Voltage Range	(Note 2)	● -0.1		$V_{CC} - 1.2$	V
V_{TRIP}^+	Input Trip Points	(Note 3)	● -2.0		5.5	mV
			● -3.0		6.5	mV
V_{TRIP}^-	Input Trip Points	(Note 3)	● -5.5		2.0	mV
			● -6.5		3.0	mV
V_{OS}	Input Offset Voltage	(Note 3)	●	1.0	3.0	mV
			●		4.5	mV
V_{HYST}	Input Hysteresis Voltage	(Note 3)	● 2.0	3.5	7.0	mV
$\Delta V_{OS}/\Delta T$	Input Offset Voltage Drift		●	10		$\mu\text{V}/^\circ\text{C}$
I_B	Input Bias Current		● -6		0	μA
I_{OS}	Input Offset Current		●		0.6	μA
CMRR	Common Mode Rejection Ratio	(Note 4)	● 55	70		dB
PSRR	Power Supply Rejection Ratio	(Note 5)	● 65	80		dB
A_V	Voltage Gain	(Note 6)		∞		
V_{OH}	Output High Voltage	$I_{SOURCE} = 4\text{mA}$, $V_{IN} = V_{TRIP}^+ + 10\text{mV}$	● $V_{CC} - 0.4$			V
V_{OL}	Output Low Voltage	$I_{SINK} = 10\text{mA}$, $V_{IN} = V_{TRIP}^- - 10\text{mV}$	●		0.4	V
t_{PD20}	Propagation Delay	$V_{OVERDRIVE} = 20\text{mV}$ (Note 7)	●	4.5	6.5	ns
			●		8.0	ns
t_{PD5}	Propagation Delay	$V_{OVERDRIVE} = 5\text{mV}$ (Notes 7, 8)	●	7	10	ns
			●		13	ns

LT1720/LT1721

ELECTRICAL CHARACTERISTICS

The ● denotes specifications that apply over the full operating temperature range, otherwise specifications are at $T_A = 25^\circ\text{C}$. $V_{CC} = 5\text{V}$, $V_{CM} = 1\text{V}$, $C_{OUT} = 10\text{pF}$, $V_{OVERDRIVE} = 20\text{mV}$, unless otherwise specified.

SYMBOL	PARAMETER	CONDITIONS	MIN	TYP	MAX	UNITS
Δt_{PD}	Differential Propagation Delay	(Note 9) Between Channels		0.3	1.0	ns
t_{SKEW}	Propagation Delay Skew	(Note 10) Between t_{PDLH}/t_{PDHL}		0.5	1.5	ns
t_r	Output Rise Time	10% to 90%		2.5		ns
t_f	Output Fall Time	90% to 10%		2.2		ns
t_{JITTER}	Output Timing Jitter	$V_{IN} = 1.2V_{P-P}$ (6dBm), $Z_{IN} = 50\Omega$ $V_{CM} = 2\text{V}$, $f = 20\text{MHz}$	t_{PDLH} t_{PDHL}	15 11		PSRMS PSRMS
f_{MAX}	Maximum Toggle Frequency	$V_{OVERDRIVE} = 50\text{mV}$, $V_{CC} = 3\text{V}$ $V_{OVERDRIVE} = 50\text{mV}$, $V_{CC} = 5\text{V}$		70.0 62.5		MHz MHz

Note 1: Stresses beyond those listed under Absolute Maximum Ratings may cause permanent damage to the device. Exposure to any Absolute Maximum Rating condition for extended periods may affect device reliability and lifetime.

Note 2: If one input is within these common mode limits, the other input can go outside the common mode limits and the output will be valid.

Note 3: The LT1720/LT1721 comparators include internal hysteresis. The trip points are the input voltage needed to change the output state in each direction. The offset voltage is defined as the average of V_{TRIP^+} and V_{TRIP^-} , while the hysteresis voltage is the difference of these two.

Note 4: The common mode rejection ratio is measured with $V_{CC} = 5\text{V}$ and is defined as the change in offset voltage measured from $V_{CM} = -0.1\text{V}$ to $V_{CM} = 3.8\text{V}$, divided by 3.9V .

Note 5: The power supply rejection ratio is measured with $V_{CM} = 1\text{V}$ and is defined as the change in offset voltage measured from $V_{CC} = 2.7\text{V}$ to $V_{CC} = 6\text{V}$, divided by 3.3V .

Note 6: Because of internal hysteresis, there is no small-signal region in which to measure gain. Proper operation of internal circuitry is ensured by measuring V_{OH} and V_{OL} with only 10mV of overdrive.

Note 7: Propagation delay measurements made with 100mV steps. Overdrive is measured relative to V_{TRIP^\pm} .

Note 8: t_{PD} cannot be measured in automatic handling equipment with low values of overdrive. The LT1720/LT1721 are 100% tested with a 100mV step and 20mV overdrive. Correlation tests have shown that t_{PD} limits can be guaranteed with this test, if additional DC tests are performed to guarantee that all internal bias conditions are correct.

Note 9: Differential propagation delay is defined as the larger of the two:

$$\Delta t_{PDLH} = t_{PDLH(MAX)} - t_{PDLH(MIN)}$$

$$\Delta t_{PDHL} = t_{PDHL(MAX)} - t_{PDHL(MIN)}$$

where (MAX) and (MIN) denote the maximum and minimum values of a given measurement across the different comparator channels.

Note 10: Propagation Delay Skew is defined as:

$$t_{SKEW} = |t_{PDLH} - t_{PDHL}|$$

TYPICAL PERFORMANCE CHARACTERISTICS

Input Offset and Trip Voltages vs Supply Voltage



Input Offset and Trip Voltages vs Temperature



Input Common Mode Limits vs Temperature



TYPICAL PERFORMANCE CHARACTERISTICS

Input Current vs Differential Input Voltage



Quiescent Supply Current vs Temperature

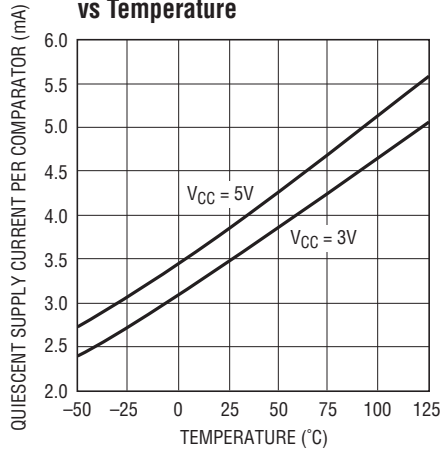

Quiescent Supply Current vs Supply Voltage

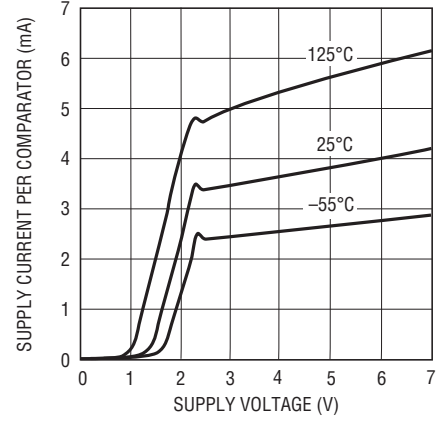

Propagation Delay vs Load Capacitance

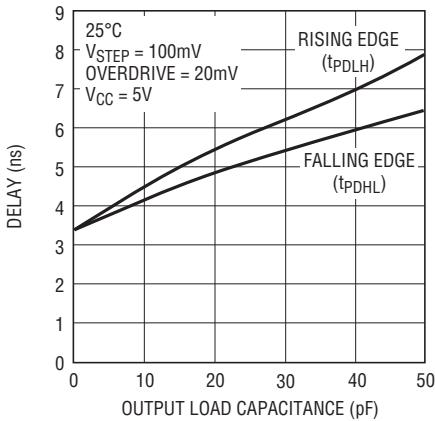

Propagation Delay vs Temperature

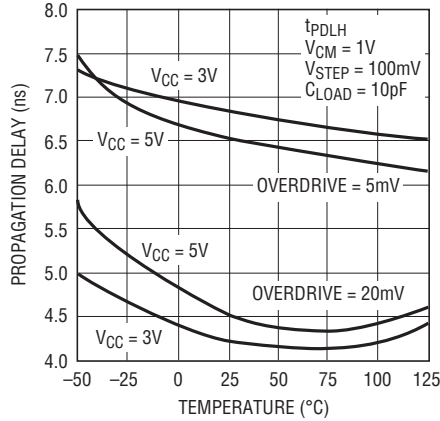

Propagation Delay vs Supply Voltage

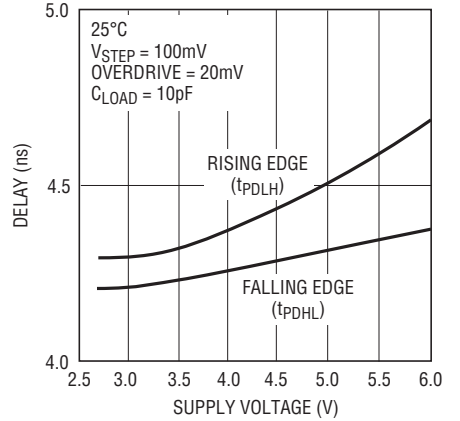

Output Low Voltage vs Load Current

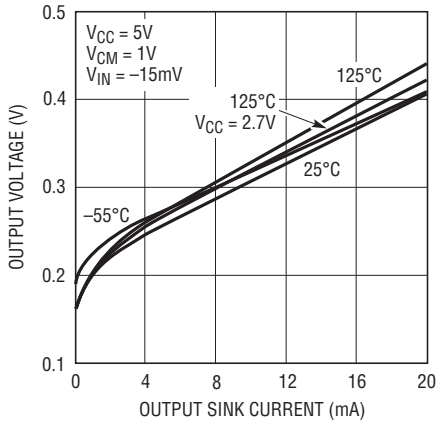

Output High Voltage vs Load Current

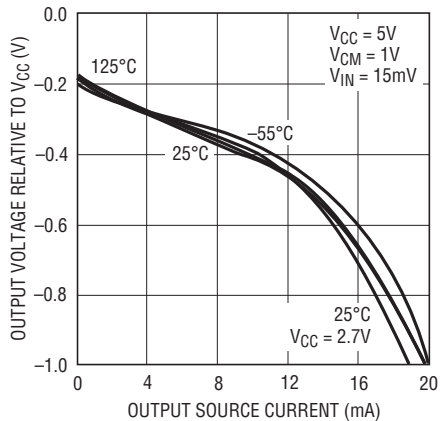

Supply Current vs Frequency

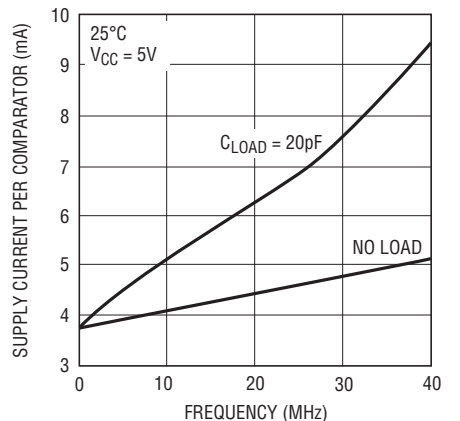

PIN FUNCTIONS

LT1720

+IN A (Pin 1): Noninverting Input of Comparator A.

-IN A (Pin 2): Inverting Input of Comparator A.

-IN B (Pin 3): Inverting Input of Comparator B.

+IN B (Pin 4): Noninverting Input of Comparator B.

GND (Pin 5): Ground.

OUT B (Pin 6): Output of Comparator B.

OUT A (Pin 7): Output of Comparator A.

V_{CC} (Pin 8): Positive Supply Voltage.

LT1721

-IN A (Pin 1): Inverting Input of Comparator A.

+IN A (Pin 2): Noninverting Input of Comparator A.

GND (Pins 3, 6): Ground.

OUT A (Pin 4): Output of Comparator A.

OUT B (Pin 5): Output of Comparator B.

+IN B (Pin 7): Noninverting Input of Comparator B.

-IN B (Pin 8): Inverting Input of Comparator B.

-IN C (Pin 9): Inverting Input of Comparator C.

+IN C (Pin 10): Noninverting Input of Comparator C.

V_{CC} (Pins 11, 14): Positive Supply Voltage.

OUT C (Pin 12): Output of Comparator C.

OUT D (Pin 13): Output of Comparator D.

+IN D (Pin 15): Noninverting Input of Comparator D.

-IN D (Pin 16): Inverting Input of Comparator D.

TEST CIRCUITS

$\pm V_{TRIP}$ Test Circuit



Response Time Test Circuit



APPLICATIONS INFORMATION

Input Voltage Considerations

The LT1720/LT1721 are specified for a common mode range of -100mV to 3.8V when used with a single 5V supply. In general the common mode range is 100mV below ground to 1.2V below V_{CC} . The criterion for this common mode limit is that the output still responds correctly to a small differential input signal. Also, if one input is within the common mode limit, the other input signal can go outside the common mode limits, up to the absolute maximum limits (a diode drop past either rail at 10mA input current) and the output will retain the correct polarity.

When either input signal falls below the negative common mode limit, the internal PN diode formed with the substrate can turn on, resulting in significant current flow through the die. An external Schottky clamp diode between the input and the negative rail can speed up recovery from negative overdrive by preventing the substrate diode from turning on.

When both input signals are below the negative common mode limit, phase reversal protection circuitry prevents false output inversion to at least -400mV common mode. However, the offset and hysteresis in this mode will increase dramatically, to as much as 15mV each. The input bias currents will also increase.

When both input signals are above the positive common mode limit, the input stage will become debiased and the output polarity will be random. However, the internal hysteresis will hold the output to a valid logic level, and because the biasing of each comparator is completely independent, there will be no impact on any other comparator. When at least one of the inputs returns to within the common mode limits, recovery from this state will take as long as $1\mu\text{s}$.

The propagation delay does not increase significantly when driven with large differential voltages. However, with low levels of overdrive, an apparent increase may be seen with large source resistances due to an RC delay caused by the 2pF typical input capacitance.

Input Protection

The input stage is protected against damage from large differential signals, up to and beyond a differential voltage equal to the supply voltage, limited only by the absolute maximum currents noted. External input protection circuitry is only needed if currents would otherwise exceed these absolute maximums. The internal catch diodes can conduct current up to these rated maximums without latchup, even when the supply voltage is at the absolute maximum rating.

The LT1720/LT1721 input stage has general purpose internal ESD protection for the human body model. For use as a line receiver, additional external protection may be required. As with most integrated circuits, the level of immunity to ESD is much greater when residing on a printed circuit board where the power supply decoupling capacitance will limit the voltage rise caused by an ESD pulse.

Unused Inputs

The inputs of any unused comparator should be tied off in a way that defines the output logic state. The easiest way to do this is to tie IN^+ to V_{CC} and IN^- to GND.

Input Bias Current

Input bias current is measured with both inputs held at 1V . As with any PNP differential input stage, the LT1720/LT1721 bias current flows out of the device. With a differential input voltage of even just 100mV or so, there will be zero bias current into the higher of the two inputs, while the current flowing out of the lower input will be twice the measured bias current. With more than two diode drops of differential input voltage, the LT1720/LT1721's input protection circuitry activates, and current out of the lower input will increase an additional 30% and there will be a small bias current into the higher of the two input pins, of $4\mu\text{A}$ or less. See the Typical Performance curve "Input Current vs Differential Input Voltage."

APPLICATIONS INFORMATION

High Speed Design Considerations

Application of high speed comparators is often plagued by oscillations. The LT1720/LT1721 have 4mV of internal hysteresis, which will prevent oscillations as long as parasitic output to input feedback is kept below 4mV. However, with the 2V/ns slew rate of the LT1720/LT1721 outputs, a 4mV step can be created at a 100Ω input source with only 0.02pF of output to input coupling. The pinouts of the LT1720/LT1721 have been arranged to minimize problems by placing the most sensitive inputs (inverting) away from the outputs, shielded by the power rails. The input and output traces of the circuit board should also be separated, and the requisite level of isolation is readily achieved if a topside ground plane runs between the outputs and the inputs. For multilayer boards where the ground plane is internal, a topside ground or supply trace should be run between the inputs and outputs, as illustrated in Figure 1.



Figure 1. Typical Topside Metal for Multilayer PCB Layouts

Figure 1a shows a typical topside layout of the LT1720 on such a multilayer board. Shown is the topside metal etch including traces, pin escape vias, and the land pads for an SO-8 LT1720 and its adjacent X7R 10nF bypass capacitor in a 1206 case.

The ground trace from Pin 5 runs under the device up to the bypass capacitor, shielding the inputs from the outputs. Note the use of a common via for the LT1720 and the bypass capacitor, which minimizes interference from high frequency energy running around the ground plane or power distribution traces.

Figure 1b shows a typical topside layout of the LT1721 on a multilayer board. In this case, the power and ground traces have been extended to the bottom of the device solely to act as high frequency shields between input and output traces.

Although both V_{CC} pins are electrically shorted internal to the LT1721, they must be shorted together externally as well in order for both to function as shields. The same is true for the two GND pins.

The supply bypass should include an adjacent 10nF ceramic capacitor and a 2.2μF tantalum capacitor no farther than 5cm away; use more capacitance if driving more than 4mA loads. To prevent oscillations, it is helpful to balance the impedance at the inverting and noninverting inputs; source impedances should be kept low, preferably 1kΩ or less.

The outputs of the LT1720/LT1721 are capable of very high slew rates. To prevent overshoot, ringing and other problems with transmission line effects, keep the output traces shorter than 10cm, or be sure to terminate the lines to maintain signal integrity. The LT1720/LT1721 can drive DC terminations of 250Ω or more, but lower characteristic impedance traces can be driven with series termination or AC termination topologies.

Hysteresis

The LT1720/LT1721 include internal hysteresis, which makes them easier to use than many other comparable speed comparators.

The input-output transfer characteristic is illustrated in Figure 2 showing the definitions of V_{OS} and V_{HYST} based upon the two measurable trip points. The hysteresis band makes the LT1720/LT1721 well behaved, even with slowly moving inputs.



Figure 2. Hysteresis I/O Characteristics

APPLICATIONS INFORMATION

The exact amount of hysteresis will vary from part to part as indicated in the specifications table. The hysteresis level will also vary slightly with changes in supply voltage and common mode voltage. A key advantage of the LT1720/LT1721 is the significant reduction in these effects, which is important whenever an LT1720/LT1721 is used to detect a threshold crossing in one direction only. In such a case, the relevant trip point will be all that matters, and a stable offset voltage with an unpredictable level of hysteresis, as seen in competing comparators, is of little value. The LT1720/LT1721 are many times better than prior comparators in these regards. In fact, the CMRR and PSRR tests are performed by checking for changes in either trip point to the limits indicated in the specifications table. Because the offset voltage is the average of the trip points, the CMRR and PSRR of the offset voltage is therefore guaranteed to be at least as good as those limits. This more stringent test also puts a limit on the common mode and power supply dependence of the hysteresis voltage.

Additional hysteresis may be added externally. The rail-to-rail outputs of the LT1720/LT1721 make this more predictable than with TTL output comparators due to the LT1720/LT1721's small variability of V_{OH} (output high voltage).

To add additional hysteresis, set up positive feedback by adding additional external resistor R3 as shown in Figure 3. Resistor R3 adds a portion of the output to the threshold set by the resistor string. The LT1720/LT1721 pulls the outputs to the supply rail and ground to within 200mV of the rails with light loads, and to within 400mV with heavy loads. For the load of most circuits, a good



Figure 3. Additional External Hysteresis

model for the voltage on the right side of R3 is 300mV or $V_{CC} - 300\text{mV}$, for a total voltage swing of $(V_{CC} - 300\text{mV}) - 300\text{mV} = V_{CC} - 600\text{mV}$.

With this in mind, calculation of the resistor values needed is a two-step process. First, calculate the value of R3 based on the additional hysteresis desired, the output voltage swing, and the impedance of the primary bias string:

$$R3 = (R1 \parallel R2)(V_{CC} - 0.6\text{V})/(\text{additional hysteresis})$$

Additional hysteresis is the desired overall hysteresis less the internal 3.5mV hysteresis.

The second step is to recalculate R2 to set the same average threshold as before. The average threshold before was set at $V_{TH} = (V_{REF})(R1)/(R1 + R2)$. The new R2 is calculated based on the average output voltage ($V_{CC}/2$) and the simplified circuit model in Figure 4. To assure that the comparator's noninverting input is, on average, the same V_{TH} as before:

$$R2' = (V_{REF} - V_{TH})/(V_{TH}/R1 + (V_{TH} - V_{CC}/2)/R3)$$

For additional hysteresis of 10mV or less, it is not uncommon for R2' to be the same as R2 within 1% resistor tolerances.

This method will work for additional hysteresis of up to a few hundred millivolts. Beyond that, the impedance of R3 is low enough to effect the bias string, and adjustment of R1 may also be required. Note that the currents through the R1/R2 bias string should be many times the input currents of the LT1720/LT1721. For 5% accuracy, the current must be at least $120\mu\text{A}$ ($6\mu\text{A} I_B \div 0.05$); more for higher accuracy.



Figure 4. Model for Additional Hysteresis Calculations

APPLICATIONS INFORMATION

Interfacing the LT1720/LT1721 to ECL

The LT1720/LT1721 comparators can be used in high speed applications where Emitter-Coupled Logic (ECL) is deployed. To interface the outputs of the LT1720/LT1721 to ECL logic inputs, standard TTL/CMOS to ECL level translators such as the 10H124, 10H424 and 100124 can be used. These components come at a cost of a few nanoseconds additional delay as well as supply currents of 50mA or more, and are only available in quads. A faster, simpler and lower power translator can be constructed with resistors as shown in Figure 5.

Figure 5a shows the standard TTL to Positive ECL (PECL) resistive level translator. This translator cannot be used for the LT1720/LT1721, or with CMOS logic, because it depends on the 820Ω resistor to limit the output swing (V_{OH}) of the all-NPN TTL gate with its so-called totem-pole output. The LT1720/LT1721 are fabricated in a complementary bipolar process and their output stage has a PNP driver that pulls the output nearly all the way to the supply rail, even when sourcing 10mA.

Figure 5b shows a three resistor level translator for interfacing the LT1720/LT1721 to ECL running off the same supply rail. No pull-down on the output of the LT1720/LT1721 is needed, but pull-down R3 limits the V_{IH} seen by the PECL gate. This is needed because ECL inputs have both a minimum and maximum V_{IH} specification for proper operation. Resistor values are given for both ECL interface types; in both cases it is assumed that the LT1720/LT1721 operates from the same supply rail.

Figure 5c shows the case of translating to PECL from an LT1720/LT1721 powered by a 3V supply rail. Again, resistor values are given for both ECL interface types. This time four resistors are needed, although with 10KH/E, R3 is not needed. In that case, the circuit resembles the standard TTL translator of Figure 5a, but the function of the new resistor, R4, is much different. R4 loads the LT1720/LT1721 output when high so that the current flowing through R1 doesn't forward bias the LT1720/LT1721's internal ESD clamp diode. Although this diode can handle 20mA without damage, normal operation and performance of the output stage can be impaired above 100μA of forward current. R4 prevents this with the minimum additional power dissipation.

Finally, Figure 5d shows the case of driving standard, negative-rail, ECL with the LT1720/LT1721. Resistor values are given for both ECL interface types and for both a 5V and 3V LT1720/LT1721 supply rail. Again, a fourth resistor, R4 is needed to prevent the low state current from flowing out of the LT1720/LT1721, turning on the internal ESD/substrate diodes. Not only can the output stage functionality and speed suffer, but in this case the substrate is common to all the comparators in the LT1720/LT1721, so operation of the other comparator(s) in the same package could also be affected. Resistor R4 again prevents this with the minimum additional power dissipation.

For all the dividers shown, the output impedance is about 110Ω. This makes these fast, less than a nanosecond, with most layouts. Avoid the temptation to use speedup capacitors. Not only can they foul up the operation of the ECL gate because of overshoots, they can damage the ECL inputs, particularly during power-up of separate supply configurations.

The level translator designs assume one gate load. Multiple gates can have significant I_{IH} loading, and the transmission line routing and termination issues also make this case difficult.

ECL, and particularly PECL, is valuable technology for high speed system design, but it must be used with care. With less than a volt of swing, the noise margins need to be evaluated carefully. Note that there is some degradation of noise margin due to the ±5% resistor selections shown. With 10KH/E, there is no temperature compensation of the logic levels, whereas the LT1720/LT1721 and the circuits shown give levels that are stable with temperature. This will degrade the noise margin over temperature. In some configurations it is possible to add compensation with diode or transistor junctions in series with the resistors of these networks.

For more information on ECL design, refer to the ECLiPS data book (DL140), the 10KH system design handbook (HB205) and PECL design (AN1406), all from ON Semiconductor (www.onsemi.com).

APPLICATIONS INFORMATION



(a) STANDARD TTL TO PECL TRANSLATOR



(b) LT1720/LT1721 OUTPUT TO PECL TRANSLATOR



(c) 3V LT1720/LT1721 OUTPUT TO PECL TRANSLATOR



(d) LT1720/LT1721 OUTPUT TO STANDARD ECL TRANSLATOR

Figure 5

17201 F05

APPLICATIONS INFORMATION

Circuit Description

The block diagram of one comparator in the LT1720/LT1721 is shown in Figure 6. There are differential inputs (+IN/-IN), an output (OUT), a single positive supply (V_{CC}) and ground (GND). All comparators are completely independent, sharing only the power and ground pins. The circuit topology consists of a differential input stage, a gain stage with hysteresis and a complementary common-emitter output stage. All of the internal signal paths utilize low voltage swings for high speed at low power.

The input stage topology maximizes the input dynamic range available without requiring the power, complexity and die area of two complete input stages such as are found in rail-to-rail input comparators. With a 2.7V supply, the LT1720/LT1721 still have a respectable 1.6V of input common mode range. The differential input voltage range is rail-to-rail, without the large input currents found in competing devices. The input stage also features phase reversal protection to prevent false outputs when the inputs are driven below the -100mV common mode voltage limit.

The internal hysteresis is implemented by positive, nonlinear feedback around a second gain stage. Until this point, the signal path has been entirely differential. The signal path is then split into two drive signals for the upper and lower output transistors. The output transistors are connected common emitter for rail-to-rail output operation. The Schottky clamps limit the output voltages at about 300mV from the rail, not quite the 50mV or 15mV of Linear

Technology's rail-to-rail amplifiers and other products. But the output of a comparator is digital, and this output stage can drive TTL or CMOS directly. It can also drive ECL, as described earlier, or analog loads as demonstrated in the applications to follow.

The bias conditions and signal swings in the output stages are designed to turn their respective output transistors off faster than on. This nearly eliminates the surge of current from V_{CC} to ground that occurs at transitions, keeping the power consumption low even with high output-toggle frequencies.

The low surge current is what keeps the power consumption low at high output-toggle frequencies. The frequency dependence of the supply current is shown in the Typical Performance Characteristics. Just 20pF of capacitive load on the output more than triples the frequency dependent rise. The slope of the no-load curve is just $32\mu\text{A}/\text{MHz}$. With a 5V supply, this current is the equivalent of charging and discharging just 6.5pF. The slope of the 20pF load curve is $133\mu\text{A}/\text{MHz}$, an addition of $101\mu\text{A}/\text{MHz}$, or $20\mu\text{A}/\text{MHz-V}$, units that are equivalent to picoFarads.

The LT1720/LT1721 dynamic current can be estimated by adding the external capacitive loading to an internal equivalent capacitance of 5pF to 15pF, multiplied by the toggle frequency and the supply voltage. Because the capacitance of routing traces can easily approach these values, the dynamic current is dominated by the load in most circuits.



Figure 6. LT1720/LT1721 Block Diagram

APPLICATIONS INFORMATION

Speed Limits

The LT1720/LT1721 comparators are intended for high speed applications, where it is important to understand a few limitations. These limitations can roughly be divided into three categories: input speed limits, output speed limits, and internal speed limits.

There are no significant input speed limits except the shunt capacitance of the input nodes. If the 2pF typical input nodes are driven, the LT1720/LT1721 will respond.

The output speed is constrained by two mechanisms, the first of which is the slew currents available from the output transistors. To maintain low power quiescent operation, the LT1720/LT1721 output transistors are sized to deliver 25mA to 45mA typical slew currents. This is sufficient to drive small capacitive loads and logic gate inputs at extremely high speeds. But the slew rate will slow dramatically with heavy capacitive loads. Because the propagation delay (t_{PD}) definition ends at the time the output voltage is halfway between the supplies, the fixed slew current actually makes the LT1720/LT1721 faster at 3V than 5V with 20mV of input overdrive.

Another manifestation of this output speed limit is skew, the difference between t_{PDLH} and t_{PDHL} . The slew currents of the LT1720/LT1721 vary with the process variations of the PNP and NPN transistors, for rising edges and falling edges respectively. The typical 0.5ns skew can have either polarity, rising edge or falling edge faster. Again, the skew will increase dramatically with heavy capacitive loads.

The skews of comparators in a single package are correlated, but not identical. Besides some random variability, there is a small (100ps to 200ps) systematic skew due to physical parasitics of the packages. For the LT1720 SO-8, comparator A, whose output is adjacent to the V_{CC} pin, will have a relatively faster rising edge than comparator B. Likewise, comparator B, by virtue of an output adjacent to the ground pin will have a relatively faster falling edge. Similar dependencies occur in the LT1721 S16, while the systemic skews in the smaller MSOP and SSOP packages are half again as small. Of course, if the capacitive loads on the two comparators of a single package are not identical, the differential timing will degrade further.

The second output speed limit is the clamp turnaround. The LT1720/LT1721 output is optimized for fast initial response, with some loss of turnaround speed, limiting the toggle frequency. The output transistors are idled in a low power state once V_{OH} or V_{OL} is reached by detecting the Schottky clamp action. It is only when the output has slewed from the old voltage to the new voltage, and the clamp circuitry has settled, that the idle state is reached and the output is fully ready to transition again. This clamp turnaround time is typically 8ns for each direction, resulting in a maximum toggle frequency of 62.5MHz, or a 125MB data rate. With higher frequencies, dropout and runt pulses can occur. Increases in capacitive load will increase the time needed for slewing due to the limited slew currents and the maximum toggle frequency will decrease further. For higher toggle frequency applications, refer to the LT1715, whose output stage can toggle at 150MHz typical.

The internal speed limits manifest themselves as dispersion. All comparators have some degree of dispersion, defined as a change in propagation delay versus input overdrive. The propagation delay of the LT1720/LT1721 will vary with overdrive, from a typical of 4.5ns at 20mV overdrive to 7ns at 5mV overdrive (typical). The LT1720/LT1721's primary source of dispersion is the hysteresis stage. As a change of polarity arrives at the gain stage, the positive feedback of the hysteresis stage subtracts from the overdrive available. Only when enough time has elapsed for a signal to propagate forward through the gain stage, backwards through the hysteresis stage and forward through the gain stage again, will the output stage receive the same level of overdrive that it would have received in the absence of hysteresis.

With 5mV of overdrive, the LT1720/LT1721 are faster with a 5V supply than with a 3V supply, the opposite of what is true with 20mV overdrive. This is due to the internal speed limit, because the gain stage is faster at 5V than 3V due primarily to the reduced junction capacitances with higher reverse voltage bias.

In many applications, as shown in the following examples, there is plenty of input overdrive. Even in applications providing low levels of overdrive, the LT1720/LT1721 are fast enough that the absolute dispersion of 2.5ns ($= 7 - 4.5$) is often small enough to ignore.

APPLICATIONS INFORMATION

The gain and hysteresis stage of the LT1720/LT1721 is simple, short and high speed to help prevent parasitic oscillations while adding minimum dispersion. This internal “self-latch” can be usefully exploited in many applications because it occurs early in the signal chain, in a low power, fully differential stage. It is therefore highly immune to disturbances from other parts of the circuit, either in the same comparator, on the supply lines, or from the other comparator(s) in the same package. Once a high speed signal trips the hysteresis, the output will respond, after a fixed propagation delay, without regard to these external influences that can cause trouble in nonhysteretic comparators.

$\pm V_{TRIP}$ Test Circuit

The input trip points are tested using the circuit shown in the Test Circuits section that precedes this Applications Information section. The test circuit uses a 1kHz triangle wave to repeatedly trip the comparator being tested. The LT1720/LT1721 output is used to trigger switched capacitor sampling of the triangle wave, with a sampler for each direction. Because the triangle wave is attenuated 1000:1 and fed to the LT1720/LT1721’s differential input, the sampled voltages are therefore 1000 times the input trip voltages. The hysteresis and offset are computed from the trip points as shown.

Crystal Oscillators

A simple crystal oscillator using one comparator of an LT1720/LT1721 is shown on the first page of this data sheet. The 2k-620 Ω resistor pair set a bias point at the comparator’s noninverting input. The 2k-1.8k-0.1 μ F path sets the inverting input node at an appropriate DC average level based on the output. The crystal’s path provides resonant positive feedback and stable oscillation occurs. Although the LT1720/LT1721 will give the correct logic output when one input is outside the common mode range, additional delays may occur when it is so operated, opening the possibility of spurious operating modes. Therefore, the DC bias voltages at the inputs are set near the center of the LT1720/LT1721’s common mode range and the 220 Ω resistor attenuates the feedback to the noninverting input. The circuit will operate with any AT-cut crystal from 1MHz to 10MHz over a 2.7V to 6V supply range.

As the power is applied, the circuit remains off until the LT1720/LT1721 bias circuits activate, at a typical V_{CC} of 2V to 2.2V (25°C), at which point the desired frequency output is generated.

The output duty cycle for this circuit is roughly 50%, but it is affected by resistor tolerances and, to a lesser extent, by comparator offsets and timings. If a 50% duty cycle is required, the circuit of Figure 7 creates a pair of complementary outputs with a forced 50% duty cycle. Crystals are narrow-band elements, so the feedback to the noninverting input is a filtered analog version of the square wave output. Changing the noninverting reference level can therefore vary the duty cycle. C1 operates as in the previous example, whereas C2 creates a complementary output by comparing the same two nodes with the opposite input polarity. A1 compares band-limited versions of the outputs and biases C1’s negative input. C1’s only degree of freedom to respond is variation of pulse width; hence the outputs are forced to 50% duty cycle. Again, the circuit operates from 2.7V to 6V, and the skew between the edges of the two outputs are shown in Figure 8. There is a slight duty cycle dependence on comparator loading, so equal capacitive and resistive loading should be used in critical applications. This circuit works well because of the two matched delays and rail-to-rail style outputs of the LT1720.



Figure 7. Crystal Oscillator with Complementary Outputs and 50% Duty Cycle

17201 F07

APPLICATIONS INFORMATION



Figure 8. Timing Skew of Figure 7's Circuit

The circuit in Figure 9 shows a crystal oscillator circuit that generates two nonoverlapping clocks by making full use of the two independent comparators of the LT1720. C1 oscillates as before, but with a lower reference level, C2's output will toggle at different times. The resistors set the degree of separation between the output's high pulses. With the values shown, each output has a 44% high and 56% low duty cycle, sufficient to allow 2ns between the high pulses. Figure 10 shows the two outputs.

The optional A1 feedback network shown can be used to force identical output duty cycles. The steady state duty cycles of both outputs will be 44%. Note, though, that the addition of this network only adjusts the percentage of time each output is high to be the same, which can be important in switching circuits requiring identical settling times. It cannot adjust the relative phases between the two outputs to be exactly 180° apart, because the signal at the input node driven by the crystal is not a pure sinusoid.

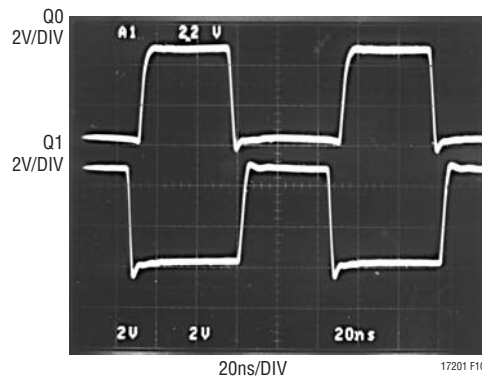

Figure 10. Nonoverlapping Outputs of Figure 9's Circuit



Figure 9. Crystal-Based Nonoverlapping 10MHz Clock Generator

APPLICATIONS INFORMATION

Timing Skews

For a number of reasons, the LT1720/LT1721's superior timing specifications make them an excellent choice for applications requiring accurate differential timing skew. The comparators in a single package are inherently well matched, with just 300ps Δt_{PD} typical. Monolithic construction keeps the delays well matched vs supply voltage and temperature. Crosstalk between the comparators, usually a disadvantage in monolithic duals and quads, has minimal effect on the LT1720/LT1721 timing due to the internal hysteresis, as described in the Speed Limits section.

The circuits of Figure 11 show basic building blocks for differential timing skews. The 2.5k resistance interacts with the 2pF typical input capacitance to create at least ± 4 ns delay, controlled by the potentiometer setting. A differential and a single-ended version are shown. In the differential configuration, the output edges can be smoothly scrolled through $\Delta t = 0$ with negligible interaction.

3ns Delay Detector

It is often necessary to measure comparative timing of pulse edges in order to determine the true synchronicity of clock and control signals, whether in digital circuitry or in high speed instrumentation. The circuit in Figure 12

is a delay detector which will output a pulse when signals X and Y are out of sync (specifically, when X is high and Y is low). Note that the addition of an identical circuit to detect the opposite situation (X low and Y high) allows for full skew detection.

Comparators U1A and U1B clean up the incoming signals and render the circuit less sensitive to input levels and slew rates. The resistive divider network provides level shifting for the downstream comparator's common mode input range, as well as offset to keep the output low except during a decisive event. When the upstream comparator's outputs can overcome the resistively generated offset (and hysteresis), comparator U1C performs a Boolean " $X^* _Y$ " function and produces an output pulse (see Figure 13). The circuit will give full output response with input delays down to 3ns and partial output response with input delays down to 1.8ns. Capacitor C1 helps ensure that an imbalance of parasitic capacitances in the layout will not cause common mode excursions to result in differential mode signal and false outputs.¹

¹ Make sure the input levels at X and Y are not too close to the 0.5V threshold set by the R8–R9 divider. If you are still getting false outputs, try increasing C1 to 10pF or more. You can also look for the problem in the impedance balance ($R5 \parallel R6 = R7$) at the inputs of U1C. Increasing the offset by lowering R5 will help reject false outputs, but R7 should also be lowered to maintain impedance balance. For ease of design and parasitic matching, R7 can be replaced by two parallel resistors equal to R5 and R6.



Figure 11. Building Blocks for Timing Skew Generation with the LT1720

APPLICATIONS INFORMATION



Figure 12. 3ns Delay Detector with Logarithmic Pulse Stretcher



Figure 13. Output Pulse Due to Delay of Y Input Pulse

APPLICATIONS INFORMATION

Optional Logarithmic Pulse Stretcher

The fourth comparator of the quad LT1721 can be put to work as a logarithmic pulse stretcher. This simple circuit can help tremendously if you don't have a fast enough oscilloscope (or control circuit) to easily capture 3ns pulse widths (or faster). When an input pulse occurs, C2 is charged up with a 180ns capture² time constant. The hysteresis and 10mV offset across R3 are overcome within the first nanosecond³, switching the comparator output high. When the input pulse subsides, C2 discharges with a 540ns time constant, keeping the comparator on until the decay overrides the 10mV offset across R3 minus hysteresis. Because of this exponential decay, the output pulse width will be proportional to the logarithm of the input pulse width. It is important to bypass the circuit's V_{CC} well to avoid coupling into the resistive divider. R4 keeps the quiescent input voltage in a range where forward leakage of the diode due to the 0.4V V_{OL} of the driving comparator is not a problem.

Neglecting some effects⁴, the output pulse is related to the input pulse as:

$$t_{OUT} = \tau_2 \cdot \ln \{V_{CH} \cdot [1 - \exp(-t_P/\tau_1)] / (V_{OFF} - V_H/2)\} - \tau_1 \cdot \ln [V_{CH} / (V_{CH} - V_{OFF} - V_H/2)] + t_P \quad (1)$$

where

t_P = input pulse width

t_{OUT} = output pulse width

τ₁ = R1 || R2 • C2 the capture time constant

τ₂ = R2 • C2 the decay time constant

V_{OFF} = 10mV the voltage drop across R1

V_H = 3.5mV LT1721 hysteresis

V_C = V_{IN} - V_{FDIODE} the input pulse voltage after the diode drop

V_{CH} = V_C • R2 / (R1 + R2) the effective source voltage for the charge

For simplicity, with t_P < τ₁, and neglecting the very slight delay in turn-on due to offset and hysteresis, the equation can be approximated by:

$$t_{OUT} = \tau_2 \cdot \ln [(V_{CH} \cdot t_P/\tau_1) / (V_{OFF} - V_H/2)] \quad (2)$$

For example, an 8ns input pulse gives a 1.67μs output pulse. Doubling the input pulse to 16ns lengthens the output pulse by 0.37μs. Doubling the input pulse again to 32ns adds another 0.37μs to the output pulse, and so on. The rate of 0.37μs per octave falls out of the above equation as:

$$\Delta t_{OUT}/\text{octave} = \tau_2 \cdot \ln(2) \quad (3)$$

There is ±0.01μs jitter⁵ in the output pulse which gives an uncertainty referred to the input pulse of less than 2% (60ps resolution on a 3ns pulse with a 60MHz oscilloscope—not bad!). The beauty of this circuit is that it gives resolution precisely where it's hardest to get. The jitter is due to a combination of the slow decay of the last few millivolts on C2 and the 4nV/√Hz noise and 400MHz bandwidth of the LT1721 input stage. Increasing the offset across R3 or decreasing τ₂ will decrease this jitter at the expense of dynamic range.

The circuit topology itself is extremely fast, limited theoretically only by the speed of the diode, the capture time constant τ₁ and the pulse source impedance. Figure 14 shows results achieved with the implementation shown, compared to a plot of Equation (1). The low end is limited by the delivery time of the upstream comparators. As the input pulse width is increased, the log function is constrained by the asymptotic RC response but, rather than becoming clamped, becomes time linear. Thus, for very long input pulses the third term of Equation (1) dominates and the circuit becomes a 3μs pulse stretcher.

² So called because the very fast input pulse is "captured," for later examination, as a charge on the capacitor.

³ Assuming the input pulse slew rate at the diode is infinite. This effective delay constant, about 0.4% of τ₁ or 0.8ns, is the second term of equation 1, below. Driven by the 2.5ns slew-limited LT1721, this effective delay will be 2ns.

⁴ V_C is dependent on the LT1721 output voltage and nonlinear diode characteristics. Also, the Thevenin equivalent charge voltage seen by C2 is boosted slightly by R2 being terminated above ground.

⁵ Output jitter increases with inputs pulse widths below ~3ns.

APPLICATIONS INFORMATION



Figure 14. Log Pulse Stretcher Output Pulse vs Input Pulse



Figure 15. RG-58 Cable with Velocity of Propagation = 66%; Delay at Y = (n - 1) • 1.54ns

You don't need expensive equipment to confirm the actual overall performance of this circuit. All you need is a respectable waveform generator (capable of >~100kHz), a splitter, a variety of cable lengths and a 20MHz or 60MHz oscilloscope. Split a single pulse source into different cable lengths and then into the delay detector, feeding the longer cable into the Y input (see Figure 15). A 6 foot cable length difference will create a ~9.2ns delay (using 66% propagation speed RG-58 cable), and should result in easily measured 1.70µs output pulses. A 12 foot cable length difference will result in ~18.4ns delay and 2.07µs output pulses. The difference

in the two output pulse widths is the per-octave response of your circuit (see Equation (3)). Shorter cable length differences can be used to get a plot of circuit performance down to 1.5ns (if any), which can then later be used as a lookup reference when you have moved from quantifying the circuit to using the circuit. (Note there is a slight aberration in performance below 10ns. See Figure 14.) As a final check, feed the circuit with identical cable lengths and check that it is not producing any output pulses.

10ns Triple Overlap Generator

The circuit of Figure 16 utilizes an LT1721 to generate three overlapping outputs whose pulse edges are separated by 10ns as shown. The time constant is set by the RC network on the output of comparator A. Comparator B and D trip at fixed percentages of the exponential voltage decay across the capacitor. The 4.22kΩ feed-forward to the C comparator's inverting input keeps the delay differences the same in each direction despite the exponential nature of the RC network's voltage.

There is a 15ns delay to the first edge in both directions, due to the 4.5ns delay of two LT1721 comparators, plus 6ns delay in the RC network. This starting delay is shortened somewhat if the pulse was shorter than 40ns because the RC network will not have fully settled; however, the 10ns edge separations stay constant.

The values shown utilize only the lowest 75% of the supply voltage span, which allows it to work down to 2.7V supply. The delay differences grow a couple nanoseconds from 5V to 2.7V supply due to the fixed V_{OL}/V_{OH} drops which grow as a percentage at low supply voltage. To keep this effect to a minimum, the 1kΩ pull-up on comparator A provides equal loading in either state.

Fast Waveform Sampler

Figure 17 uses a diode-bridge-type switch for clean, fast waveform sampling. The diode bridge, because of its inherent symmetry, provides lower AC errors than other semiconductor-based switching technologies. This circuit features 20dB of gain, 10MHz full power bandwidth and 100µV/°C baseline uncertainty. Switching delay is less than 15ns and the minimum sampling window width for full power response is 30ns.

APPLICATIONS INFORMATION



Figure 16. 10ns Triple Overlap Generator



Figure 17. Fast Waveform Sampler Using the LT1720 for Timing-Skew Compensation

APPLICATIONS INFORMATION

The input waveform is presented to the diode bridge switch, the output of which feeds the LT1227 wideband amplifier. The LT1720 comparators, triggered by the sample command, generate phase-opposed outputs. These signals are level shifted by the transistors, providing complementary bipolar drive to switch the bridge. A skew compensation trim ensures bridge-drive signal simultaneity within 1ns. The AC balance corrects for parasitic capacitive bridge imbalances. A DC balance adjustment trims bridge offset.

The trim sequence involves grounding the input via 50Ω and applying a 100kHz sample command. The DC balance is adjusted for minimal bridge ON vs OFF variation at the output. The skew compensation and AC

balance adjustments are then optimized for minimum AC disturbance in the output. Finally, unground the the input and the circuit is ready for use.

Voltage-Controlled Clock Skew Generator

It is sometimes necessary to generate pairs of identical clock signals that are phase skewed in time. Further, it is desirable to be able to set the amount of time skew via a tuning voltage. Figure 18's circuit does this by utilizing the LT1720 to digitize phase information from a varactor-tuned time domain bridge. A 0V to 2V control signal provides $\approx \pm 10\text{ns}$ of output skew. This circuit operates from a 2.7V to 6V supply.



17201 F18

APPLICATIONS INFORMATION

Coincidence Detector

High speed comparators are especially suited for interfacing pulse-output transducers, such as particle detectors, to logic circuitry. The matched delays of a monolithic dual are well suited for those cases where the coincidence of two pulses needs to be detected. The circuit of Figure 19 is a coincidence detector that uses an LT1720 and discrete components as a fast AND gate.

The reference level is set to 1V, an arbitrary threshold. Only when both input signals exceed this will a coincidence be detected. The Schottky diodes from the comparator outputs to the base of the MRF-501 form the AND gate, while the other two Schottkys provide for fast turn-off.

A logic AND gate could instead be used, but would add considerably more delay than the 300ps contributed by this discrete stage.

This circuit can detect coincident pulses as narrow as 3ns. For narrower pulses, the output will degrade gracefully, responding, but with narrow pulses that don't rise all the way to "high" before starting to fall. The decision delay is 4.5ns with input signals 50mV or more above the reference level. This circuit creates a TTL compatible output but it can typically drive CMOS as well.

For a more detailed description of the operation of this circuit, see Application Note 75, pages 10 and 11.

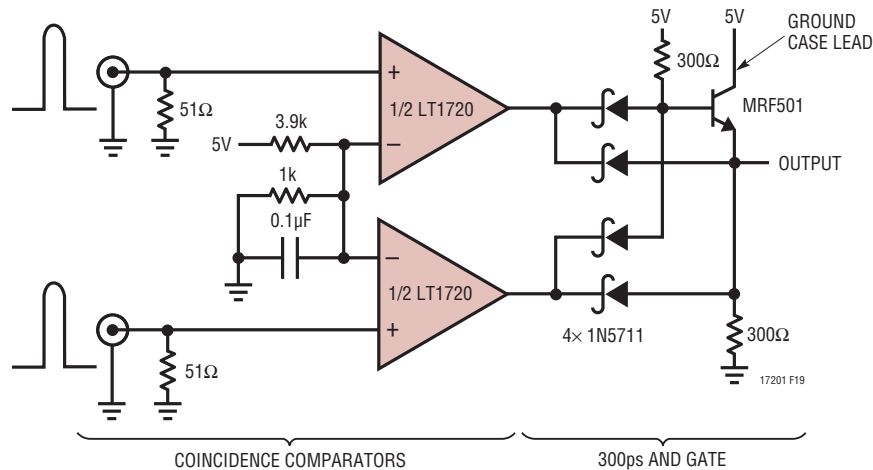

Figure 19. A 3ns Coincidence Detector

SIMPLIFIED SCHEMATIC



PACKAGE DESCRIPTION

DD Package
8-Lead Plastic DFN (3mm × 3mm)
 (Reference LTC DWG # 05-08-1698)



S8 Package
8-Lead Plastic Small Outline (Narrow .150 Inch)
 (Reference LTC DWG # 05-08-1610)



PACKAGE DESCRIPTION

MS8 Package
8-Lead Plastic MSOP
 (Reference LTC DWG # 05-08-1660)



S Package
16-Lead Plastic Small Outline (Narrow .150 Inch)
 (Reference LTC DWG # 05-08-1610)



PACKAGE DESCRIPTION

GN Package
16-Lead Plastic SSOP (Narrow .150 Inch)
 (Reference LTC DWG # 05-08-1641)



NOTE:

1. CONTROLLING DIMENSION: INCHES
2. DIMENSIONS ARE IN $\frac{\text{INCHES}}{\text{MILLIMETERS}}$
3. DRAWING NOT TO SCALE

*DIMENSION DOES NOT INCLUDE MOLD FLASH. MOLD FLASH SHALL NOT EXCEED 0.006" (0.152mm) PER SIDE

**DIMENSION DOES NOT INCLUDE INTERLEAD FLASH. INTERLEAD FLASH SHALL NOT EXCEED 0.010" (0.254mm) PER SIDE

TYPICAL APPLICATION

Pulse Stretcher

For detecting short pulses from a single sensor, a pulse stretcher is often required. The circuit of Figure 20 acts as a one-shot, stretching the width of an incoming pulse to a consistent 100ns. Unlike a logic one-shot, this LT1720-based circuit requires only 100pV-s of stimulus to trigger.

The circuit works as follows: Comparator C1 functions as a threshold detector, whereas comparator C2 is configured as a one-shot. The first comparator is prebiased with a threshold of 8mV to overcome comparator and system offsets and establish a low output in the absence of an input signal. An input pulse sends the output of C1 high, which in turn latches C2's output high. The output of C2 is fed back to the input of the first comparator, causing regeneration and latching both outputs high. Timing

capacitor C now begins charging through R and, at the end of 100ns, C2 resets low. The output of C1 also goes low, latching both outputs low. A new pulse at the input of C1 can now restart the process. Timing capacitor C can be increased without limit for longer output pulses.

This circuit has an ultimate sensitivity of better than 14mV with 5ns to 10ns input pulses. It can even detect an avalanche generated test pulse of just 1ns duration with sensitivity better than 100mV.⁶ It can detect short events better than the coincidence detector of Figure 14 because the one-shot is configured to catch just 100mV of upward movement from C1's V_{OL} , whereas the coincidence detector's 3ns specification is based on a full, legitimate logic high, without the help of a regenerative one-shot.

⁶ See Linear Technology Application Note 47, Appendix B. This circuit can detect the output of the pulse generator described after 40dB attenuation.



Figure 20. A 1ns Pulse Stretcher

RELATED PARTS

PART NUMBER	DESCRIPTION	COMMENTS
LT1016	UltraFast Precision Comparator	Industry Standard 10ns Comparator
LT1116	12ns Single Supply Ground-Sensing Comparator	Single Supply Version of LT1016
LT1394	7ns, UltraFast, Single Supply Comparator	6mA Single Supply Comparator
LT1671	60ns, Low Power, Single Supply Comparator	450μA Single Supply Comparator
LT1715	4ns, 150MHz Dual Comparator	Similar to the LT1720 with Independent Input/Output Supplies
LT1719	4.5ns Single Supply 3V/5V Comparator	Single Comparator Similar to the LT1720/LT1721

17201fc

Компания «Life Electronics» занимается поставками электронных компонентов импортного и отечественного производства от производителей и со складов крупных дистрибьюторов Европы, Америки и Азии.

С конца 2013 года компания активно расширяет линейку поставок компонентов по направлению коаксиальный кабель, кварцевые генераторы и конденсаторы (керамические, пленочные, электролитические), за счёт заключения дистрибьюторских договоров

Мы предлагаем:

- Конкурентоспособные цены и скидки постоянным клиентам.
- Специальные условия для постоянных клиентов.
- Подбор аналогов.
- Поставку компонентов в любых объемах, удовлетворяющих вашим потребностям.
- Приемлемые сроки поставки, возможна ускоренная поставка.
- Доставку товара в любую точку России и стран СНГ.
- Комплексную поставку.
- Работу по проектам и поставку образцов.
- Формирование склада под заказчика.
- Сертификаты соответствия на поставляемую продукцию (по желанию клиента).
- Тестирование поставляемой продукции.
- Поставку компонентов, требующих военную и космическую приемку.
- Входной контроль качества.
- Наличие сертификата ISO.

В составе нашей компании организован Конструкторский отдел, призванный помогать разработчикам, и инженерам.

Конструкторский отдел помогает осуществить:

- Регистрацию проекта у производителя компонентов.
- Техническую поддержку проекта.
- Защиту от снятия компонента с производства.
- Оценку стоимости проекта по компонентам.
- Изготовление тестовой платы монтаж и пусконаладочные работы.



Тел: +7 (812) 336 43 04 (многоканальный)

Email: org@lifeelectronics.ru