

# 2ch IPS (Intelligent Power Switch)

## BDS2EJAAGUL

### General Description

**BDS2EJAAGUL is an intelligent power switch IC (IPS) that has two built-in N-channel MOSFETs capable of carrying 1A current. This switch IC operates from low input voltages from 0.9V to 3.6V and exhibits a typical on-resistance of 45 mΩ. Built-in safety features include soft-start, over current protection with fold back current limiting, under voltage lockout, thermal shut down and reverse current protection when power is switched off. BDS2EJAAGUL is available in a space-saving VCSP50L1 package and uses an internal N-channel MOSFET for discharging output capacitance.**

### Features

- Dual N-MOS FET high side switch (Typ 45mΩ).
- Built-in soft start circuit.
- Built-in over current protection circuit (OCP).
- Built-in thermal shut down circuit (TSD).
- Built-in N-channel MOSFET to discharge output capacitance
- Reverse-current protection.
- Input sequence free.

### Applications

- Digital Cameras
- Smartphones
- Notebook PC
- Tablet PC

### Typical Application Circuits

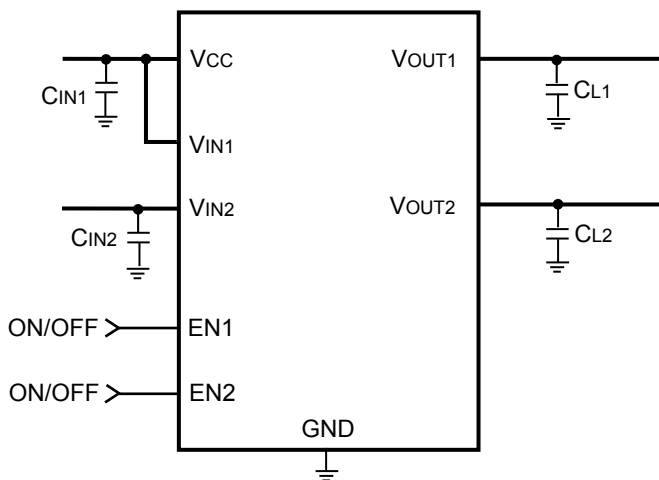

Figure.1 Application circuit for 1A 2ch IPS

### Key Specifications

- |                                |                 |
|--------------------------------|-----------------|
| ■ Vcc Input voltage range:     | 3.0V to 3.6V    |
| ■ Switch input voltage range:  | 0.9V to 3.6V    |
| ■ Enable input voltage range:  | -0.3V to 5.5V   |
| ■ Switch output voltage range: | 0V to 3.6V      |
| ■ Maximum output current:      | 1A (Max)        |
| ■ Standby current:             | 0μA (Typ)       |
| ■ Operating temperature range: | -40°C to +100°C |

### Package(s)

VCSP50L1

### W(Typ) x D(Typ) x H(Max)

1.95mm x 1.00mm x 0.55mm

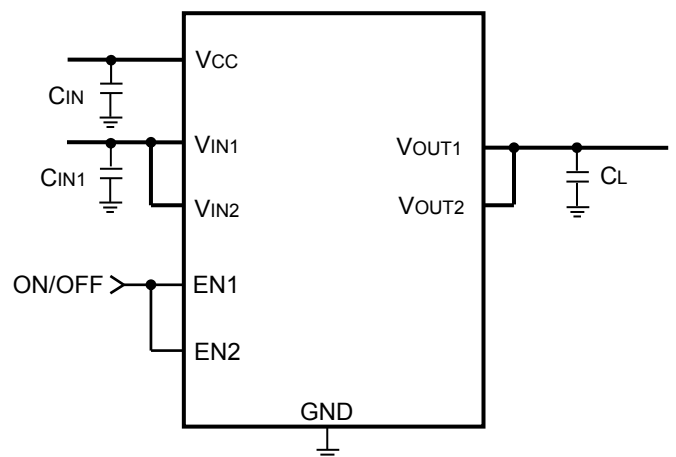

Figure.2 Application circuit for 2A 1ch IPS

Block diagram

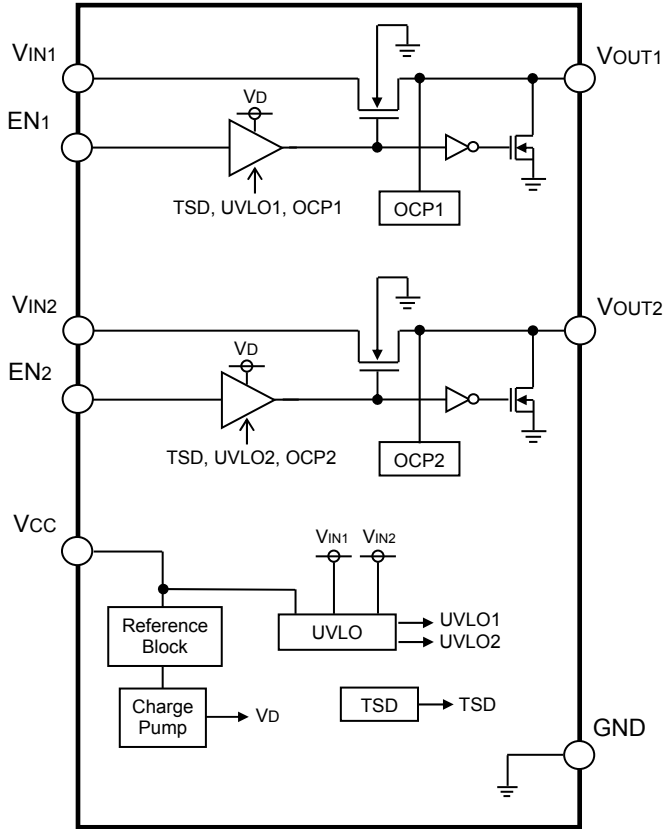

Figure.3 Block diagram

Pin configuration

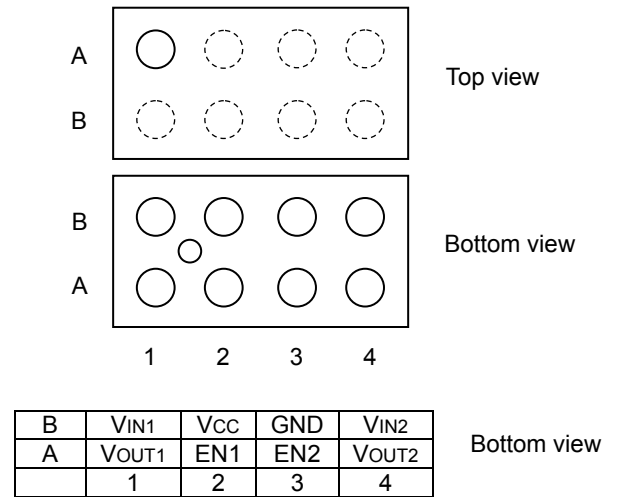

Figure.4 Pin configuration

Pin descriptions

Pin No.	Pin name	Pin function
A1	VOUT1	Switch1 output
A2	EN1	Enable1 input
A3	EN2	Enable2 input
A4	VOUT2	Switch2 output
B1	VIN1	Switch1 input
B2	VCC	Power supply input
B3	GND	Ground
B4	VIN2	Switch2 output

## Absolute maximum ratings (Ta=25°C)

Parameter	Symbol	Ratings	Unit
Supply voltage	VCC	-0.3 to 4.5	V
Switch input voltage	VIN1, VIN2	-0.3 to 4.5 (Note 1)	V
Enable input voltage	VEN1, VEN2	-0.3 to 7.0	V
Switch output voltage1	VOUT1	-0.3 to VIN1	V
Switch output voltage2	VOUT2	-0.3 to VIN2	V
Power dissipation	VCSP50L1 Pd	0.66 (Note 2)	W
Operating temperature range	Topr	-40 to +100	°C
Storage temperature range	Tstg	-55 to +150	°C
Junction temperature	Tjmax	150	°C

(Note1) Pd, ASO should not be exceeded

(Note2) Derating is done 5.3 mW/°C for operating above Ta ≥ 25°C (Mount on 8-layer 50.0mm x 58.0mm x 1.75mm glass-epoxy board)

**Caution:** Operating the IC over the absolute maximum ratings may damage the IC. The damage can either be a short circuit between pins or an open circuit between pins and the internal circuitry. Therefore, it is important to consider circuit protection measures, such as adding a fuse, in case the IC is operated over the absolute maximum ratings.

## Recommended operating ratings (Ta=25°C)

Parameter	Symbol	Ratings		Unit
		Min	Max	
Supply voltage	VCC	3.0	3.6	V
Switch input voltage	VIN1, VIN2	0.9	3.6	V
Enable input voltage	VEN1, VEN2	0.0	5.5	V
Output current	Io	0.0	1.0 (Note 3)	A

(Note3) Pd, ASO should not be exceeded

## Electrical characteristics (Unless otherwise noted, Ta=25°C, VCC=3.3V, VIN1=3.3V, VIN2=1.8V, VEN1=VEN2=3.3V)

Parameter	Symbol	Limits			Unit	Conditions
		Min	Typ	Max		
Circuit current at shutdown mode	ICC_STB	-	0	5	μA	VEN1=VEN2=0V
Switch current at shutdown mode	IIN_STB	-	0	5	μA	VEN1=VEN2=0V
Bias current	ICC	-	200	300	μA	
[Enable block]						
EN high voltage	VENH	2.0	-	5.5	V	Switch on
EN low voltage	VENL	-0.2	-	0.8	V	Switch off
EN bias current	IEN	1	3.3	6	μA	VEN=3.3V
[1ch, 2ch Switch block]						
ON resistance	RON	-	45	90	mΩ	Tj=-40 to 100°C
Discharge ON resistance	RON_DIS	-	30	100	Ω	
OCP threshold current	IOCP	1	-	-	A	
[Under voltage lockout block]						
VCC UVLO threshold voltage	VUVLO_VCC	2.6	2.8	3.0	V	Sweep up
VIN1, VIN2 UVLO threshold voltage	VUVLO_VIN	0.65	0.75	0.85	V	Sweep up

Measurement circuit

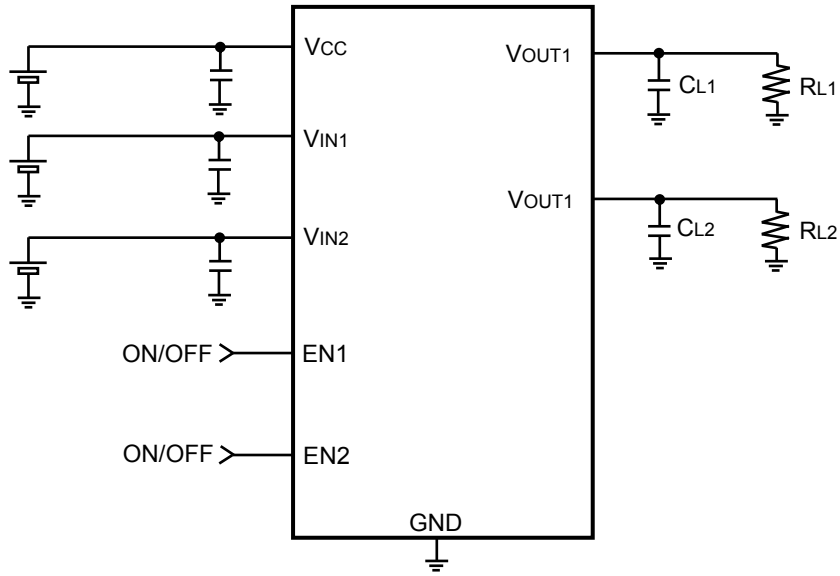

Figure.5 Measurement circuit

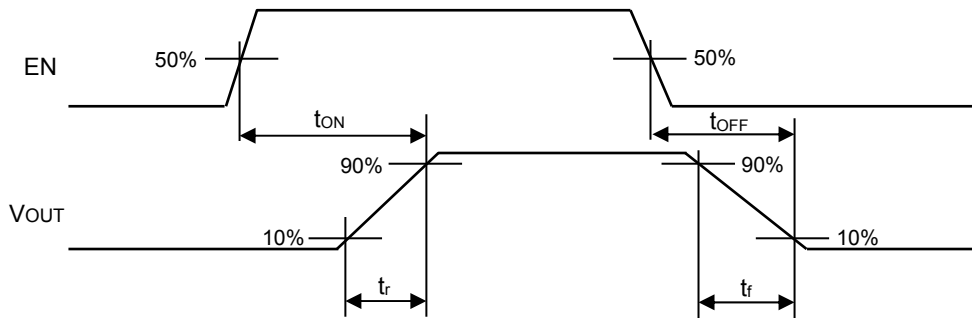

Figure.6 Timing diagram

Typical performance curves

(Unless otherwise noted,  $T_a=25^\circ\text{C}$ ,  $EN1=EN2=3.3\text{V}$ ,  $V_{CC}=3.3\text{V}$ ,  $V_{IN1}=3.3\text{V}$ ,  $V_{IN2}=1.8\text{V}$ )

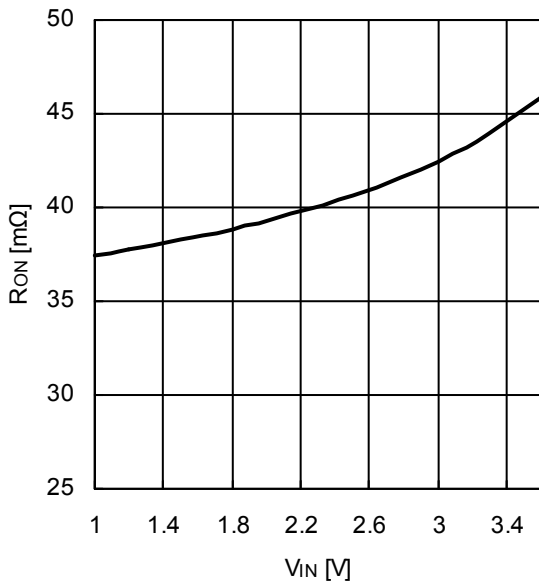

Figure.7 VIN-ROn

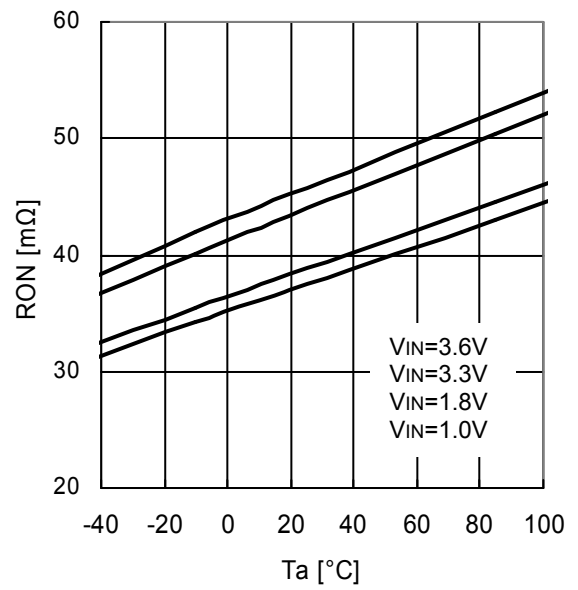

Figure.8 Ta-ROn

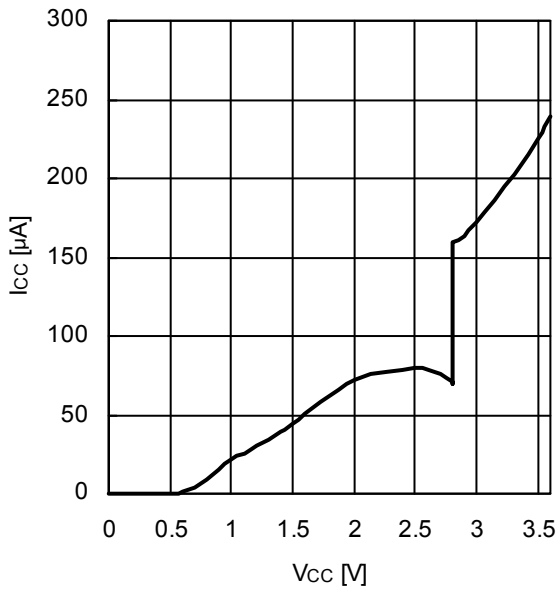

Figure.9 VCC-Icc

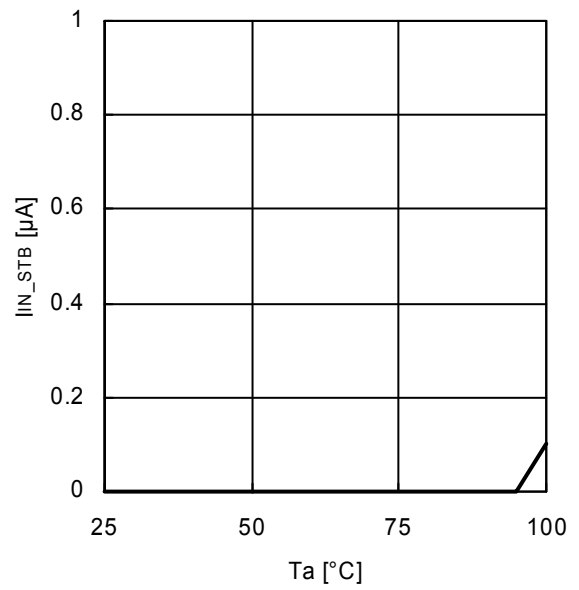

Figure.10 Ta-IIN\_STB  
(VIN=3.6V, EN1=EN2=0V)

Typical Performance Curves - continued

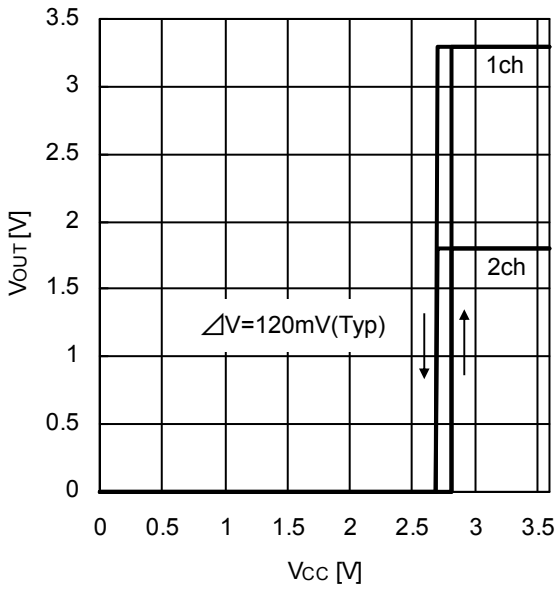

Figure.11 Vcc-Vout

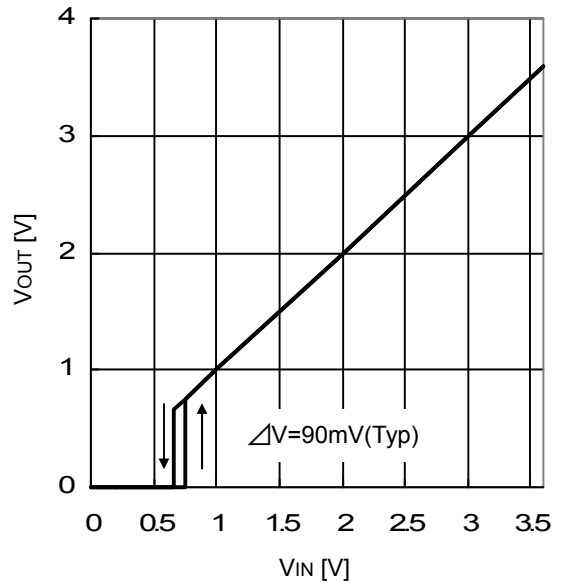

Figure.12 VIN-Vout

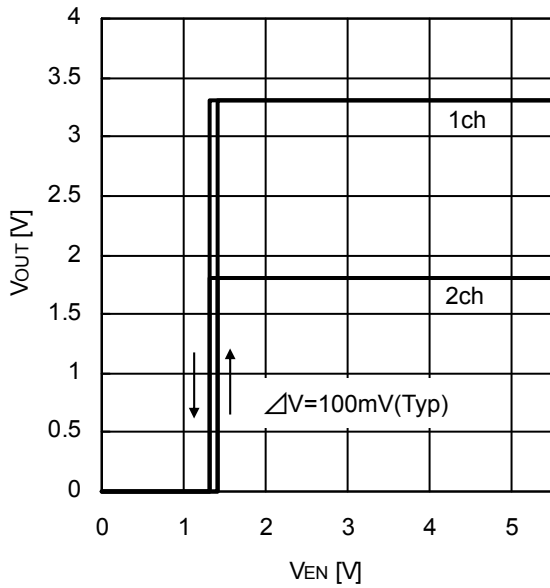

Figure.13 VEN-Vout

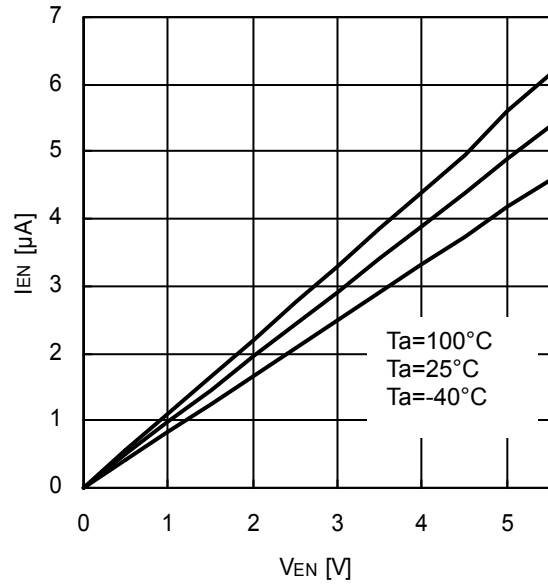

Figure.14 VEN-IEN

Typical Performance Curves - continued

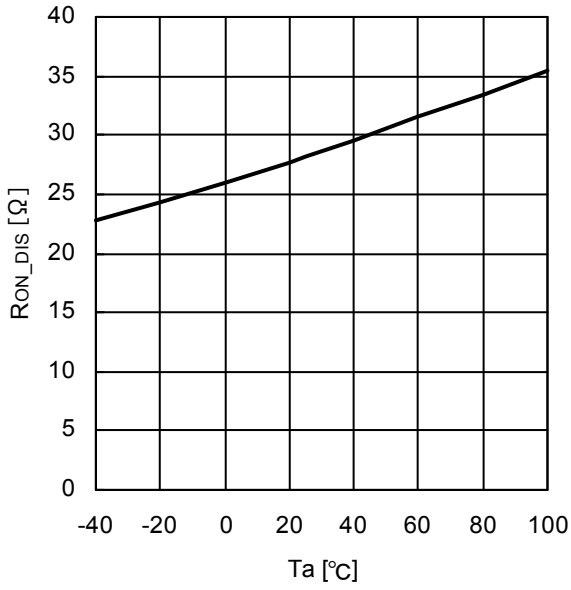

Figure.15 Ta-RO<sub>N</sub>\_DIS

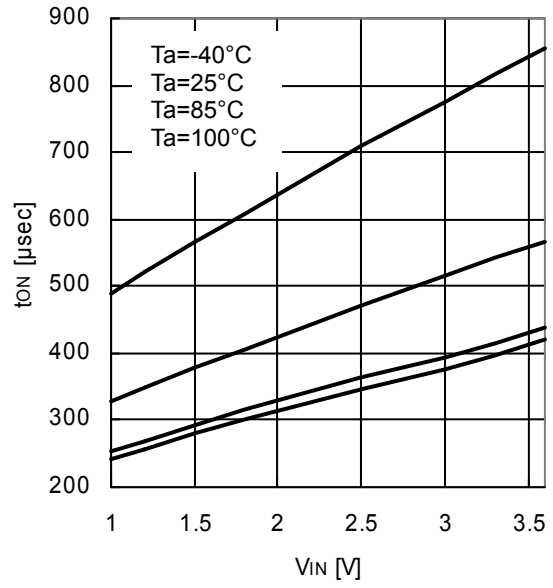

Figure.16 VIN-ton  
(CL=0.1μF RL=47Ω)

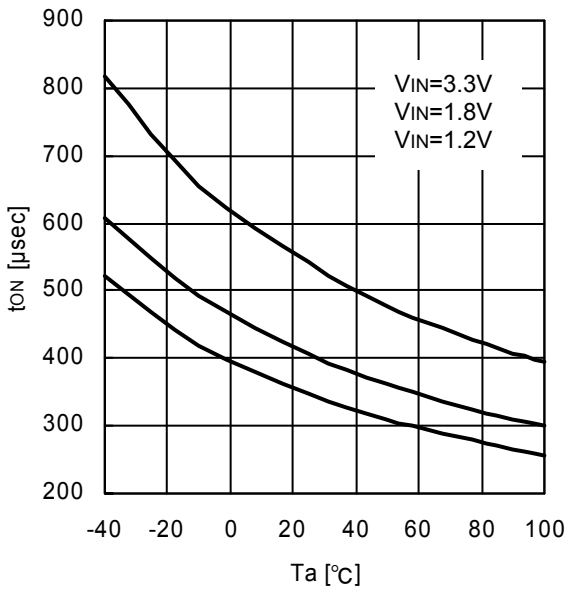

Figure.17 Ta-ton  
(CL=0.1μF RL=47Ω)

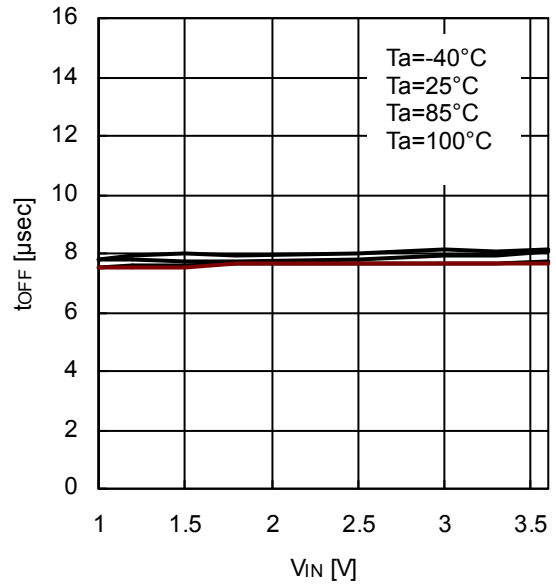

Figure.18 VIN-toFF  
(CL=0.1μF RL=47Ω)

Typical Performance Curves - continued

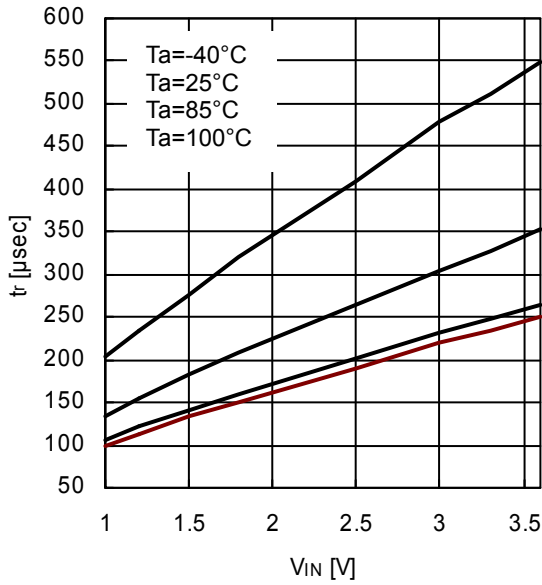

Figure.19  $V_{IN}$ - $t_r$   
( $C_L=0.1\mu\text{F}$   $R_L=47\Omega$ )

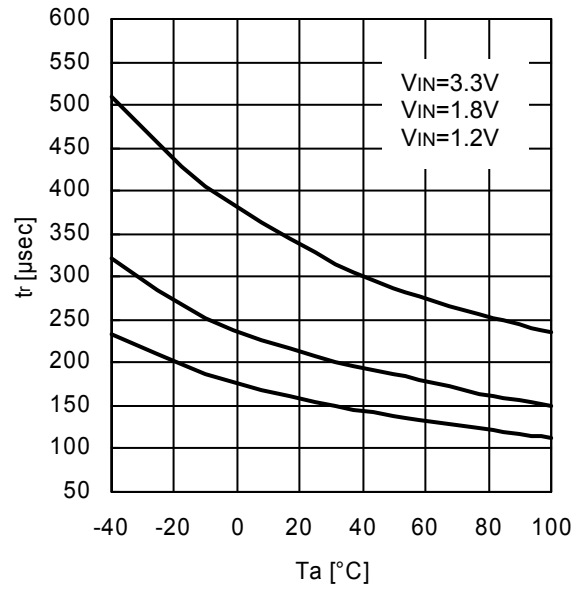

Figure.20  $T_a$ - $t_r$   
( $C_L=0.1\mu\text{F}$   $R_L=47\Omega$ )

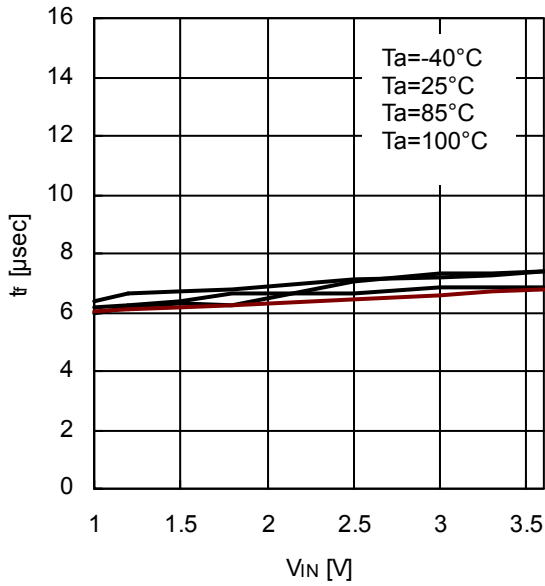

Figure.21  $V_{IN}$ - $t_r$   
( $C_L=0.1\mu\text{F}$   $R_L=47\Omega$ )

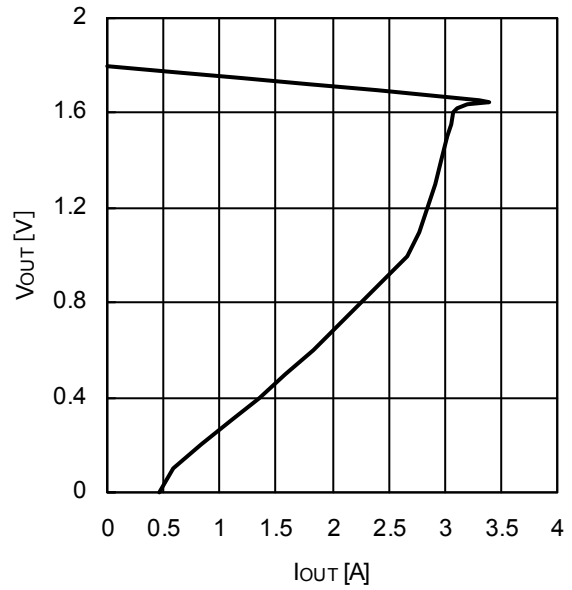

Figure.22  $I_{OUT}$ - $V_{OUT}$  ( $V_{IN}=1.8\text{V}$ )



Typical Performance Curves - continued

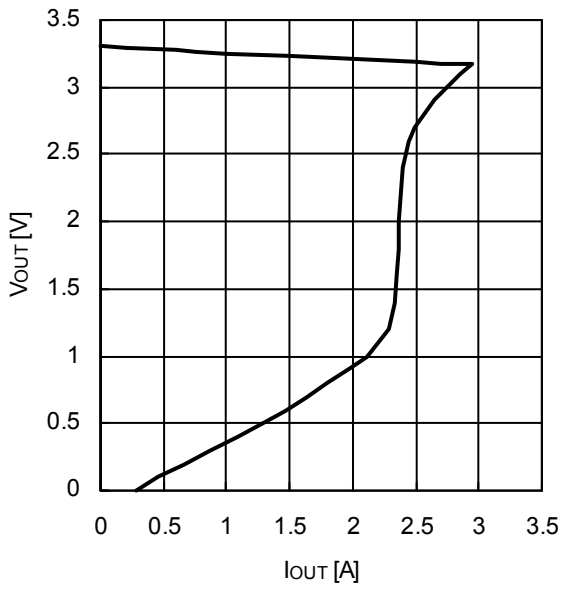

Figure.23 I<sub>OUT</sub>-V<sub>OUT</sub> (V<sub>IN</sub>=3.3V)

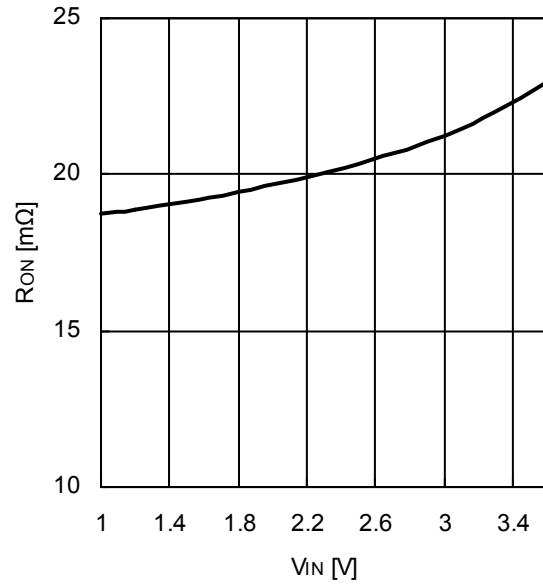

Figure.24 V<sub>IN</sub>-R<sub>ON</sub>  
(1ch IPS : Refer to Figure.2)

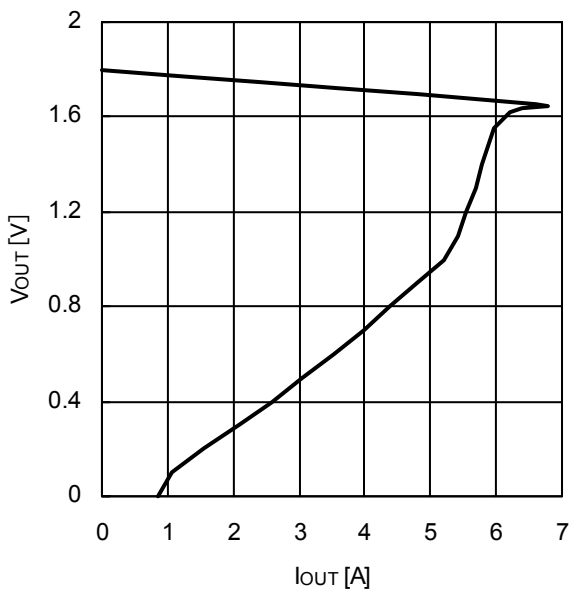

Figure.25 I<sub>OUT</sub>-V<sub>OUT</sub> (V<sub>IN</sub>=1.8V)  
(1ch IPS: Refer to Figure.2)

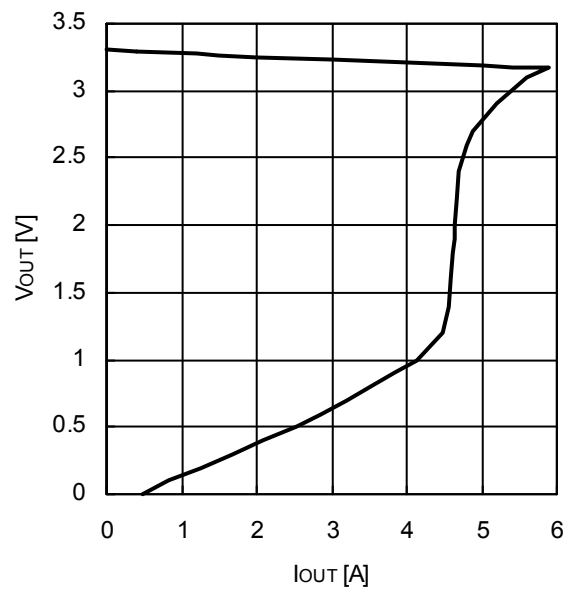

Figure.26 I<sub>OUT</sub>-V<sub>OUT</sub> (V<sub>IN</sub>=3.3V)  
(1ch IPS: Refer to Figure.2)

Typical Performance Curves - continued

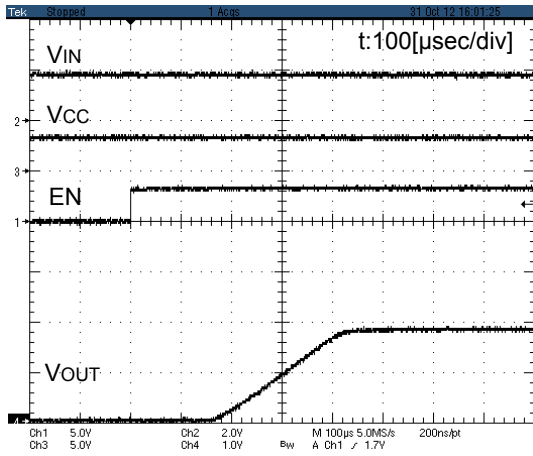

Figure.27 Turn on response1 (VIN=1.8V EN:ON)

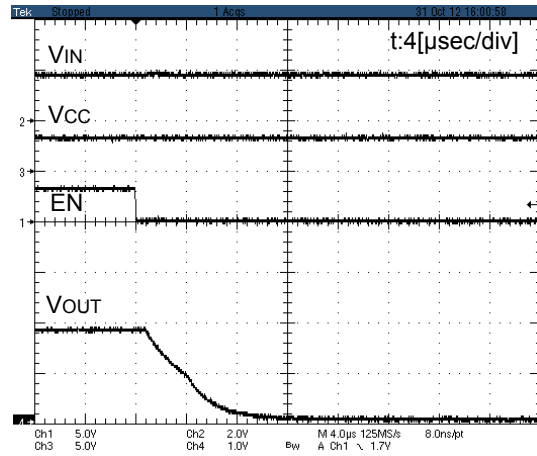

Figure.28 Turn off response1 (VIN=1.8V EN:OFF)

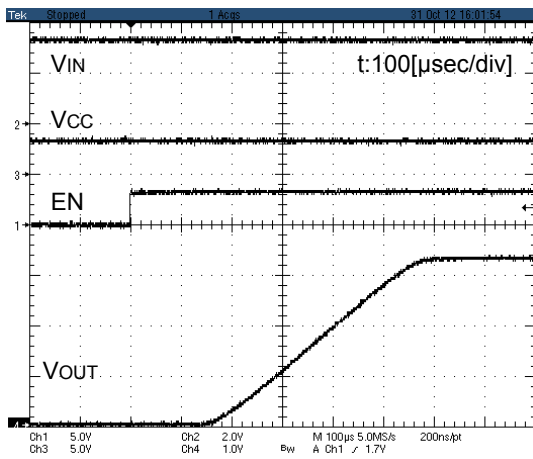

Figure.29 Turn on response2 (VIN=3.3V EN:ON)

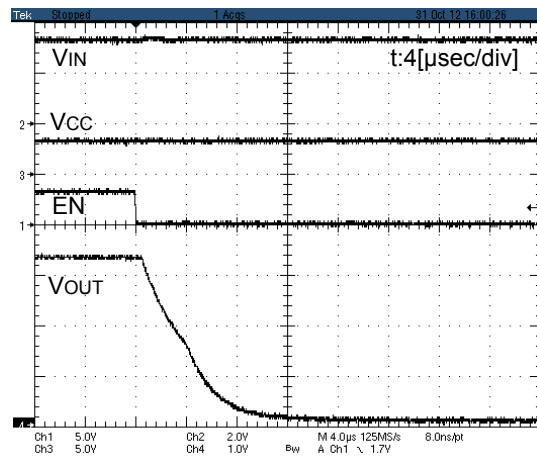

Figure.30 Turn off response2 (VIN=3.3V EN:OFF)

Typical Performance Curves - continued

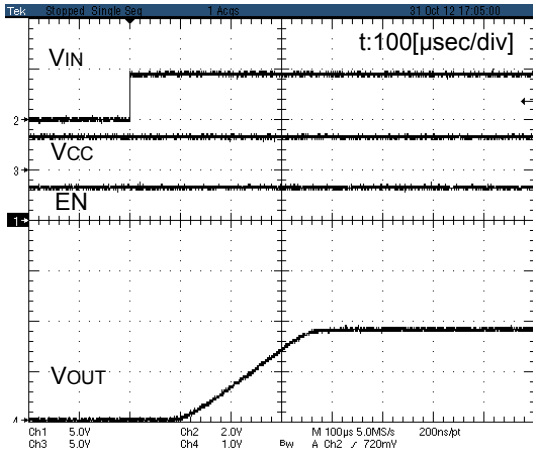

Figure.31 Turn on response3 (VIN=1.8V VIN:ON)

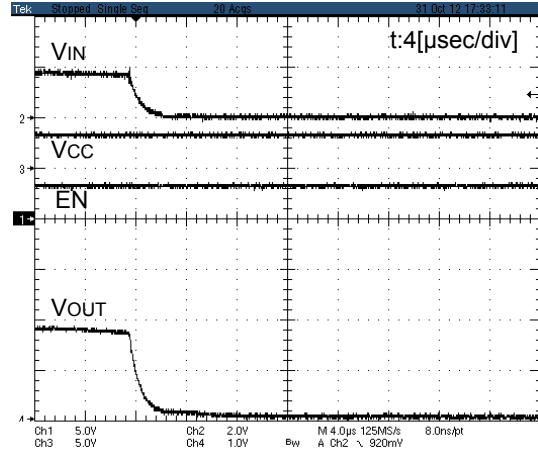

Figure.32 Turn off response3 (VIN=1.8V VIN:OFF)

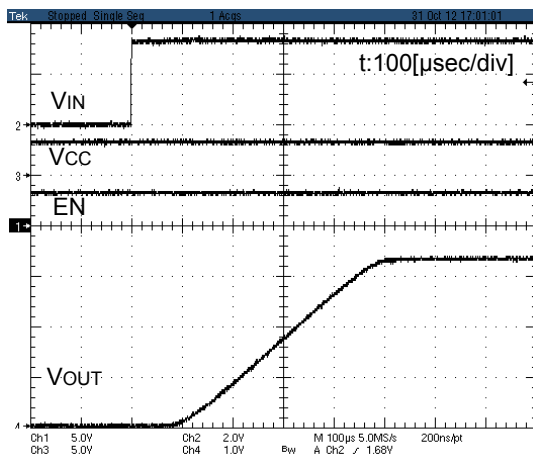

Figure.33 Turn on response4 (VIN=3.3V VIN:ON)

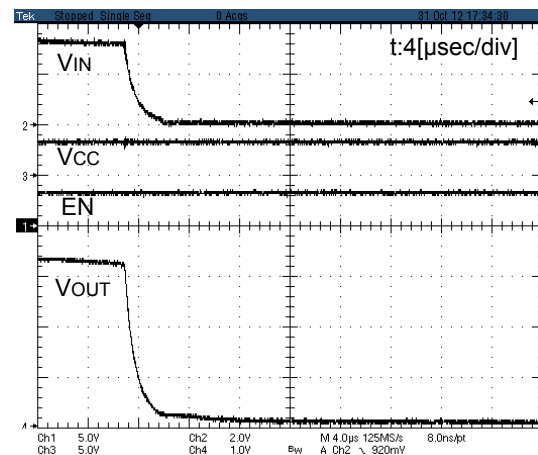

Figure.34 Turn off response4 (VIN=3.3V VIN:OFF)

Typical Performance Curves - continued

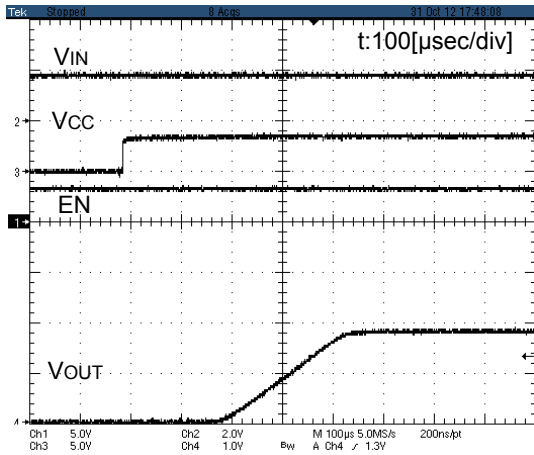

Figure.35 Turn on response5 (VIN=1.8V Vcc:ON)

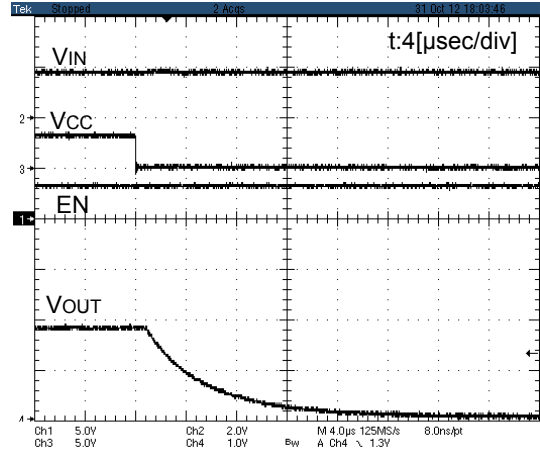

Figure.36 Turn off response5 (VIN=1.8V Vcc:OFF)

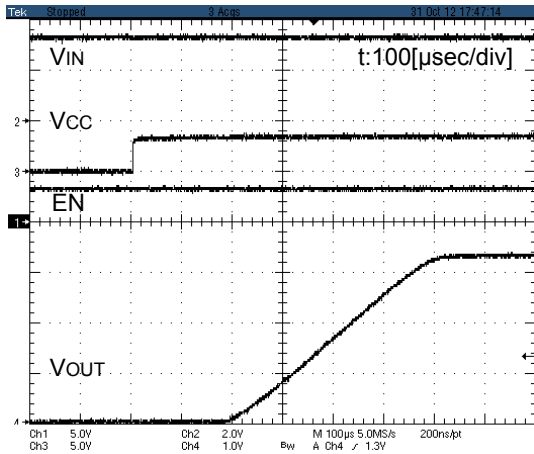

Figure.37 Turn on response6 (VIN=3.3V Vcc:ON)

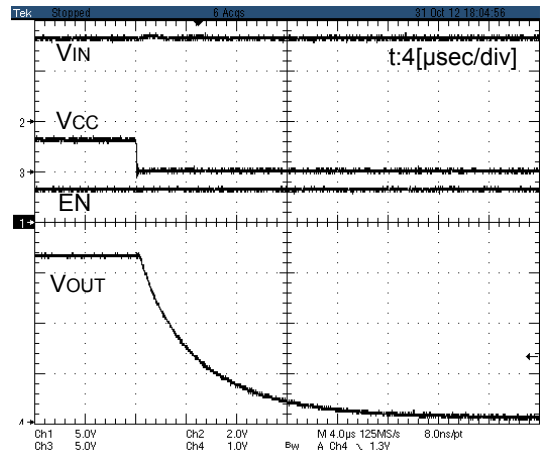
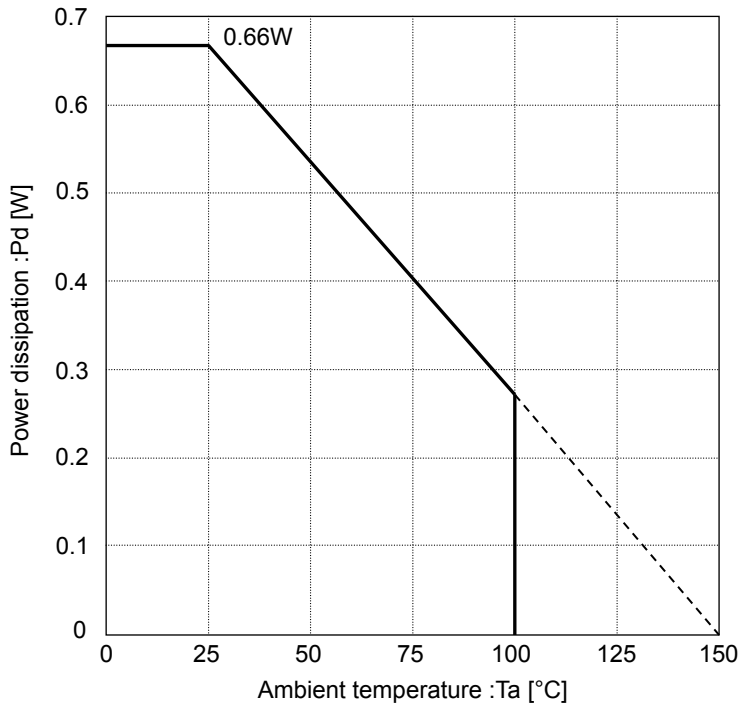

Figure.38 Turn off response6 (VIN=3.3V Vcc:OFF)

Power dissipation

©VCSP50L1



Measurement condition : mounted on a ROHM board  
 Board size : 50mm x 58mm x 1.75mm  
 8-layer :  $\theta_{j-a}=188.7^{\circ}\text{C/W}$

Figure.39 Power dissipation curve

I/O equivalent circuits

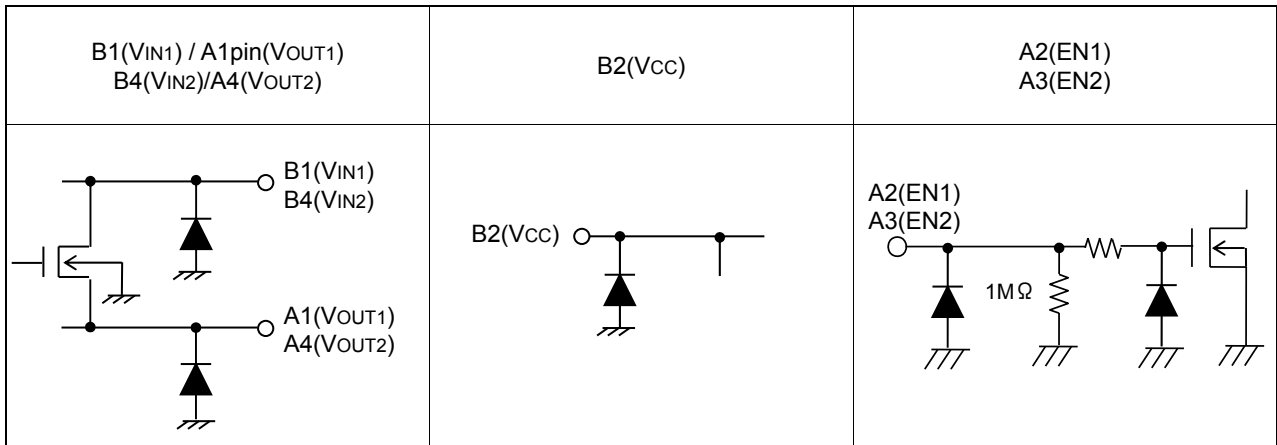

Application information

It is recommended that an input bypass decoupling capacitor (over 0.1μF) is placed near the IC between the Vcc and GND pins. This capacitor between input and GND pins is necessary when there is high impedance on the power supply or if the power trace is long. Larger values of input capacitor (over 0.1μF), will result in better line regulation and will improve power characteristics during load change.

However, please confirm IC operation by mounting this device on a board for the actual application.

## Operational Notes

### 1. Reverse Connection of Power Supply

Connecting the power supply in reverse polarity can damage the IC. Take precautions against reverse polarity when connecting the power supply, such as mounting an external diode between the power supply and the IC's power supply pins.

### 2. Power Supply Lines

Design the PCB layout pattern to provide low impedance supply lines. Furthermore, connect a capacitor to ground at all power supply pins. Consider the effect of temperature and aging on the capacitance value when using electrolytic capacitors.

### 3. Ground Voltage

Ensure that no pins are at a voltage below that of the ground pin at any time, even during transient condition.

### 4. Ground Wiring Pattern

When using both small-signal and large-current ground traces, the two ground traces should be routed separately but connected to a single ground at the reference point of the application board to avoid fluctuations in the small-signal ground caused by large currents. Also ensure that the ground traces of external components do not cause variations on the ground voltage. The ground lines must be as short and thick as possible to reduce line impedance.

### 5. Thermal Consideration

Should by any chance the power dissipation rating be exceeded the rise in temperature of the chip may result in deterioration of the properties of the chip. In case of exceeding this absolute maximum rating, increase the board size and copper area to prevent exceeding the Pd rating.

### 6. Recommended Operating Conditions

These conditions represent a range within which the expected characteristics of the IC can be approximately obtained. The electrical characteristics are guaranteed under the conditions of each parameter.

### 7. Inrush Current

When power is first supplied to the IC, it is possible that the internal logic may be unstable and inrush current may flow instantaneously due to the internal powering sequence and delays, especially if the IC has more than one power supply. Therefore, give special consideration to power coupling capacitance, power wiring, width of ground wiring, and routing of connections.

### 8. Operation Under Strong Electromagnetic Field

Operating the IC in the presence of a strong electromagnetic field may cause the IC to malfunction.

### 9. Testing on Application Boards

When testing the IC on an application board, connecting a capacitor directly to a low-impedance output pin may subject the IC to stress. Always discharge capacitors completely after each process or step. The IC's power supply should always be turned off completely before connecting or removing it from the test setup during the inspection process. To prevent damage from static discharge, ground the IC during assembly and use similar precautions during transport and storage.

### 10. Inter-pin Short and Mounting Errors

Ensure that the direction and position are correct when mounting the IC on the PCB. Incorrect mounting may result in damaging the IC. Avoid nearby pins being shorted to each other especially to ground, power supply and output pin. Inter-pin shorts could be due to many reasons such as metal particles, water droplets (in very humid environment) and unintentional solder bridge deposited in between pins during assembly to name a few.

### 11. Unused Input Pins

Input pins of an IC are often connected to the gate of a MOS transistor. The gate has extremely high impedance and extremely low capacitance. If left unconnected, the electric field from the outside can easily charge it. The small charge acquired in this way is enough to produce a significant effect on the conduction through the transistor and cause unexpected operation of the IC. So unless otherwise specified, unused input pins should be connected to the power supply or ground line.

## Operational Notes – continued

**12. Regarding the Input Pin of the IC**

This monolithic IC contains P+ isolation and P substrate layers between adjacent elements in order to keep them isolated. P-N junctions are formed at the intersection of the P layers with the N layers of other elements, creating a parasitic diode or transistor. For example (refer to figure below):

When  $GND > Pin A$  and  $GND > Pin B$ , the P-N junction operates as a parasitic diode.

When  $GND > Pin B$ , the P-N junction operates as a parasitic transistor.

Parasitic diodes inevitably occur in the structure of the IC. The operation of parasitic diodes can result in mutual interference among circuits, operational faults, or physical damage. Therefore, conditions that cause these diodes to operate, such as applying a voltage lower than the GND voltage to an input pin (and thus to the P substrate) should be avoided.

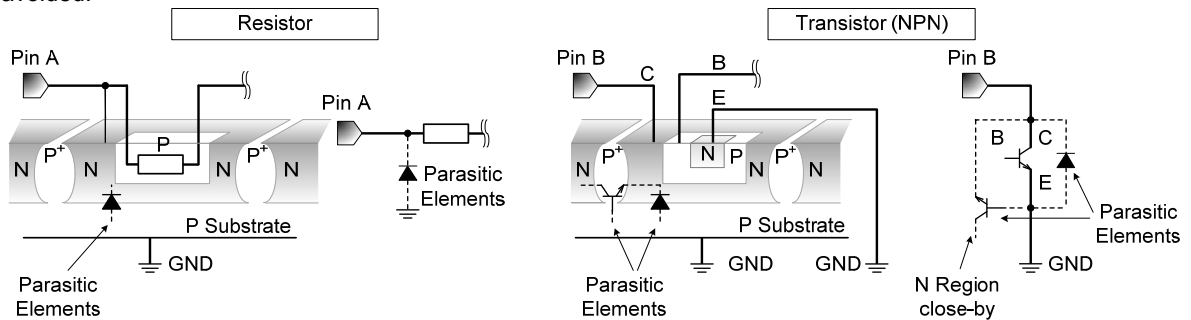

Figure xx. Example of monolithic IC structure

**13. Ceramic Capacitor**

When using a ceramic capacitor, determine the dielectric constant considering the change of capacitance with temperature and the decrease in nominal capacitance due to DC bias and others.

**14. Area of Safe Operation (ASO)**

Operate the IC such that the output voltage, output current, and power dissipation are all within the Area of Safe Operation (ASO).

**15. Thermal Shutdown Circuit(TSD)**

This IC has a built-in thermal shutdown circuit that prevents heat damage to the IC. Normal operation should always be within the IC's power dissipation rating. If however the rating is exceeded for a continued period, the junction temperature ( $T_j$ ) will rise which will activate the TSD circuit that will turn OFF all output pins. When the  $T_j$  falls below the TSD threshold, the circuits are automatically restored to normal operation.

Note that the TSD circuit operates in a situation that exceeds the absolute maximum ratings and therefore, under no circumstances, should the TSD circuit be used in a set design or for any purpose other than protecting the IC from heat damage.

**16. Over Current Protection Circuit (OCP)**

This IC incorporates an integrated overcurrent protection circuit that is activated when the load is shorted. This protection circuit is effective in preventing damage due to sudden and unexpected incidents. However, the IC should not be used in applications characterized by continuous operation or transitioning of the protection circuit.

**17. Disturbance light**

In a device where a portion of silicon is exposed to light such as in a WL-CSP, IC characteristics may be affected due to photoelectric effect. For this reason, it is recommended to come up with countermeasures that will prevent the chip from being exposed to light.

Ordering information

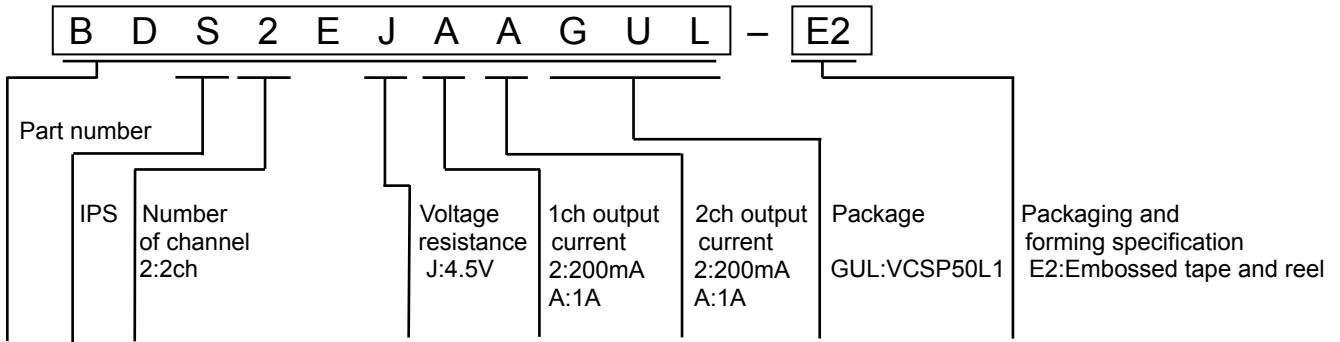

Marking diagram

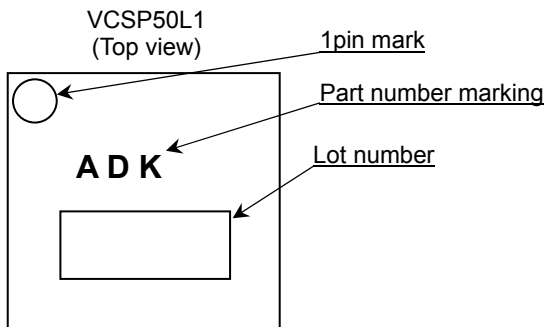



Package name	VCSP50L1
--------------	----------

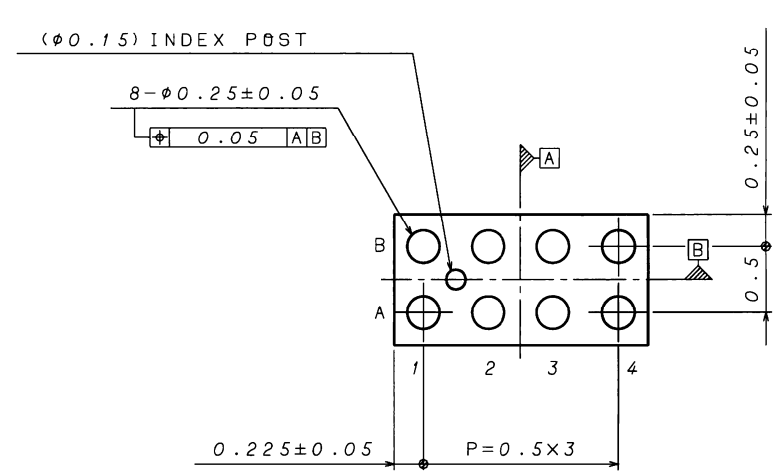
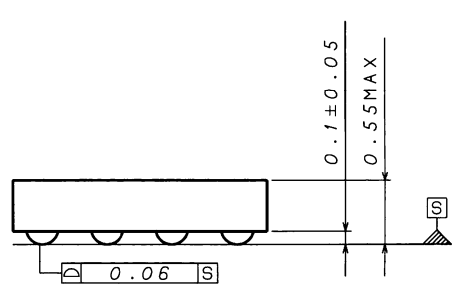
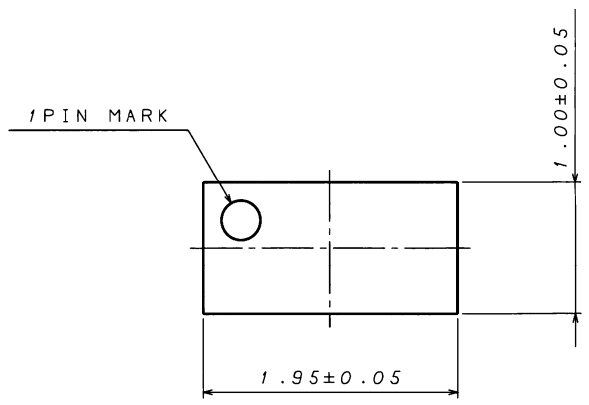

(UNIT : mm)

Drawing No: EX912-5067

< Tape and Reel Information >

Tape	Embossed carrier tape
Quantity	3000pcs/Reel
Direction of feed	E2 ( The direction is the 1 pin of product is at the upper left when you hold ) reel on the left hand and you pull out the tape on the right hand

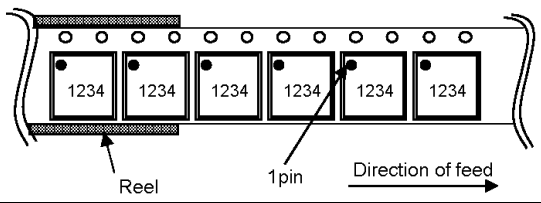

Revision history

Date	Revision	Changes
04.Jun.2015	001	New release

# Notice

## Precaution on using ROHM Products

- Our Products are designed and manufactured for application in ordinary electronic equipments (such as AV equipment, OA equipment, telecommunication equipment, home electronic appliances, amusement equipment, etc.). If you intend to use our Products in devices requiring extremely high reliability (such as medical equipment <sup>(Note 1)</sup>, transport equipment, traffic equipment, aircraft/spacecraft, nuclear power controllers, fuel controllers, car equipment including car accessories, safety devices, etc.) and whose malfunction or failure may cause loss of human life, bodily injury or serious damage to property ("Specific Applications"), please consult with the ROHM sales representative in advance. Unless otherwise agreed in writing by ROHM in advance, ROHM shall not be in any way responsible or liable for any damages, expenses or losses incurred by you or third parties arising from the use of any ROHM's Products for Specific Applications.

(Note1) Medical Equipment Classification of the Specific Applications

JAPAN	USA	EU	CHINA
CLASS III	CLASS III	CLASS II b	CLASS III
CLASS IV		CLASS III	

- ROHM designs and manufactures its Products subject to strict quality control system. However, semiconductor products can fail or malfunction at a certain rate. Please be sure to implement, at your own responsibilities, adequate safety measures including but not limited to fail-safe design against the physical injury, damage to any property, which a failure or malfunction of our Products may cause. The following are examples of safety measures:
  - Installation of protection circuits or other protective devices to improve system safety
  - Installation of redundant circuits to reduce the impact of single or multiple circuit failure
- Our Products are designed and manufactured for use under standard conditions and not under any special or extraordinary environments or conditions, as exemplified below. Accordingly, ROHM shall not be in any way responsible or liable for any damages, expenses or losses arising from the use of any ROHM's Products under any special or extraordinary environments or conditions. If you intend to use our Products under any special or extraordinary environments or conditions (as exemplified below), your independent verification and confirmation of product performance, reliability, etc. prior to use, must be necessary:
  - Use of our Products in any types of liquid, including water, oils, chemicals, and organic solvents
  - Use of our Products outdoors or in places where the Products are exposed to direct sunlight or dust
  - Use of our Products in places where the Products are exposed to sea wind or corrosive gases, including Cl<sub>2</sub>, H<sub>2</sub>S, NH<sub>3</sub>, SO<sub>2</sub>, and NO<sub>2</sub>
  - Use of our Products in places where the Products are exposed to static electricity or electromagnetic waves
  - Use of our Products in proximity to heat-producing components, plastic cords, or other flammable items
  - Sealing or coating our Products with resin or other coating materials
  - Use of our Products without cleaning residue of flux (even if you use no-clean type fluxes, cleaning residue of flux is recommended); or Washing our Products by using water or water-soluble cleaning agents for cleaning residue after soldering
  - Use of the Products in places subject to dew condensation
- The Products are not subject to radiation-proof design.
- Please verify and confirm characteristics of the final or mounted products in using the Products.
- In particular, if a transient load (a large amount of load applied in a short period of time, such as pulse. is applied, confirmation of performance characteristics after on-board mounting is strongly recommended. Avoid applying power exceeding normal rated power; exceeding the power rating under steady-state loading condition may negatively affect product performance and reliability.
- De-rate Power Dissipation (Pd) depending on Ambient temperature (Ta). When used in sealed area, confirm the actual ambient temperature.
- Confirm that operation temperature is within the specified range described in the product specification.
- ROHM shall not be in any way responsible or liable for failure induced under deviant condition from what is defined in this document.

## Precaution for Mounting / Circuit board design

- When a highly active halogenous (chlorine, bromine, etc.) flux is used, the residue of flux may negatively affect product performance and reliability.
- In principle, the reflow soldering method must be used on a surface-mount products, the flow soldering method must be used on a through hole mount products. If the flow soldering method is preferred on a surface-mount products, please consult with the ROHM representative in advance.

For details, please refer to ROHM Mounting specification

**Precautions Regarding Application Examples and External Circuits**

1. If change is made to the constant of an external circuit, please allow a sufficient margin considering variations of the characteristics of the Products and external components, including transient characteristics, as well as static characteristics.
2. You agree that application notes, reference designs, and associated data and information contained in this document are presented only as guidance for Products use. Therefore, in case you use such information, you are solely responsible for it and you must exercise your own independent verification and judgment in the use of such information contained in this document. ROHM shall not be in any way responsible or liable for any damages, expenses or losses incurred by you or third parties arising from the use of such information.

**Precaution for Electrostatic**

This Product is electrostatic sensitive product, which may be damaged due to electrostatic discharge. Please take proper caution in your manufacturing process and storage so that voltage exceeding the Products maximum rating will not be applied to Products. Please take special care under dry condition (e.g. Grounding of human body / equipment / solder iron, isolation from charged objects, setting of Ionizer, friction prevention and temperature / humidity control).

**Precaution for Storage / Transportation**

1. Product performance and soldered connections may deteriorate if the Products are stored in the places where:
  - [a] the Products are exposed to sea winds or corrosive gases, including Cl<sub>2</sub>, H<sub>2</sub>S, NH<sub>3</sub>, SO<sub>2</sub>, and NO<sub>2</sub>
  - [b] the temperature or humidity exceeds those recommended by ROHM
  - [c] the Products are exposed to direct sunshine or condensation
  - [d] the Products are exposed to high Electrostatic
2. Even under ROHM recommended storage condition, solderability of products out of recommended storage time period may be degraded. It is strongly recommended to confirm solderability before using Products of which storage time is exceeding the recommended storage time period.
3. Store / transport cartons in the correct direction, which is indicated on a carton with a symbol. Otherwise bent leads may occur due to excessive stress applied when dropping of a carton.
4. Use Products within the specified time after opening a humidity barrier bag. Baking is required before using Products of which storage time is exceeding the recommended storage time period.

**Precaution for Product Label**

QR code printed on ROHM Products label is for ROHM's internal use only.

**Precaution for Disposition**

When disposing Products please dispose them properly using an authorized industry waste company.

**Precaution for Foreign Exchange and Foreign Trade act**

Since concerned goods might be fallen under listed items of export control prescribed by Foreign exchange and Foreign trade act, please consult with ROHM in case of export.

**Precaution Regarding Intellectual Property Rights**

1. All information and data including but not limited to application example contained in this document is for reference only. ROHM does not warrant that foregoing information or data will not infringe any intellectual property rights or any other rights of any third party regarding such information or data.
2. ROHM shall not have any obligations where the claims, actions or demands arising from the combination of the Products with other articles such as components, circuits, systems or external equipment (including software).
3. No license, expressly or implied, is granted hereby under any intellectual property rights or other rights of ROHM or any third parties with respect to the Products or the information contained in this document. Provided, however, that ROHM will not assert its intellectual property rights or other rights against you or your customers to the extent necessary to manufacture or sell products containing the Products, subject to the terms and conditions herein.

**Other Precaution**

1. This document may not be reprinted or reproduced, in whole or in part, without prior written consent of ROHM.
2. The Products may not be disassembled, converted, modified, reproduced or otherwise changed without prior written consent of ROHM.
3. In no event shall you use in any way whatsoever the Products and the related technical information contained in the Products or this document for any military purposes, including but not limited to, the development of mass-destruction weapons.
4. The proper names of companies or products described in this document are trademarks or registered trademarks of ROHM, its affiliated companies or third parties.

**General Precaution**

1. Before you use our Products, you are requested to carefully read this document and fully understand its contents. ROHM shall not be in any way responsible or liable for failure, malfunction or accident arising from the use of any ROHM's Products against warning, caution or note contained in this document.
2. All information contained in this document is current as of the issuing date and subject to change without any prior notice. Before purchasing or using ROHM's Products, please confirm the latest information with a ROHM sales representative.
3. The information contained in this document is provided on an "as is" basis and ROHM does not warrant that all information contained in this document is accurate and/or error-free. ROHM shall not be in any way responsible or liable for any damages, expenses or losses incurred by you or third parties resulting from inaccuracy or errors of or concerning such information.

# Mouser Electronics

Authorized Distributor

Click to View Pricing, Inventory, Delivery & Lifecycle Information:

[ROHM Semiconductor:](#)

[BDS2EJAAGUL-E2](#)

Компания «Life Electronics» занимается поставками электронных компонентов импортного и отечественного производства от производителей и со складов крупных дистрибьюторов Европы, Америки и Азии.

С конца 2013 года компания активно расширяет линейку поставок компонентов по направлению коаксиальный кабель, кварцевые генераторы и конденсаторы (керамические, пленочные, электролитические), за счёт заключения дистрибьюторских договоров

Мы предлагаем:

- Конкурентоспособные цены и скидки постоянным клиентам.
- Специальные условия для постоянных клиентов.
- Подбор аналогов.
- Поставку компонентов в любых объемах, удовлетворяющих вашим потребностям.
- Приемлемые сроки поставки, возможна ускоренная поставка.
- Доставку товара в любую точку России и стран СНГ.
- Комплексную поставку.
- Работу по проектам и поставку образцов.
- Формирование склада под заказчика.
- Сертификаты соответствия на поставляемую продукцию (по желанию клиента).
- Тестирование поставляемой продукции.
- Поставку компонентов, требующих военную и космическую приемку.
- Входной контроль качества.
- Наличие сертификата ISO.

В составе нашей компании организован Конструкторский отдел, призванный помогать разработчикам, и инженерам.

Конструкторский отдел помогает осуществить:

- Регистрацию проекта у производителя компонентов.
- Техническую поддержку проекта.
- Защиту от снятия компонента с производства.
- Оценку стоимости проекта по компонентам.
- Изготовление тестовой платы монтаж и пусконаладочные работы.



Тел: +7 (812) 336 43 04 (многоканальный)  
Email: [org@lifeelectronics.ru](mailto:org@lifeelectronics.ru)