

High and Low Side Driver

Features

- Floating channel designed for bootstrap operation
- Fully operational to +600 V
- Tolerant to negative transient voltage
- dV/dt immune
- Gate drive supply range from 10 V to 20 V
- Undervoltage lockout for both channels
- 3.3 V and 5 V logic compatible
- Matched propagation delay for both channels
- Logic and power ground +/- 5 V offset
- Lower di/dt gate driver for better noise immunity
- Output source/sink current 4 A / 4 A
- RoHS compliant

Description

The IRS2186(4) are high voltage, high speed power MOSFET and IGBT drivers with independent high-side and low-side referenced output channels. Proprietary HVIC and latch immune CMOS technologies enable ruggedized monolithic construction. The logic input is compatible with standard CMOS or LSTTL output, down to 3.3 V logic. The output drivers feature a high pulse current buffer stage designed for minimum driver cross-conduction. The floating channel can be used to drive an N-channel power MOSFET or IGBT in the high-side configuration which operates up to 600 V.

Product Summary

V_{OFFSET}	600 V
$I_{\text{O+/-}}$	4 A / 4 A
V_{OUT}	10 V – 20 V
Ton/off (typ.)	170 & 170 ns

Package Options

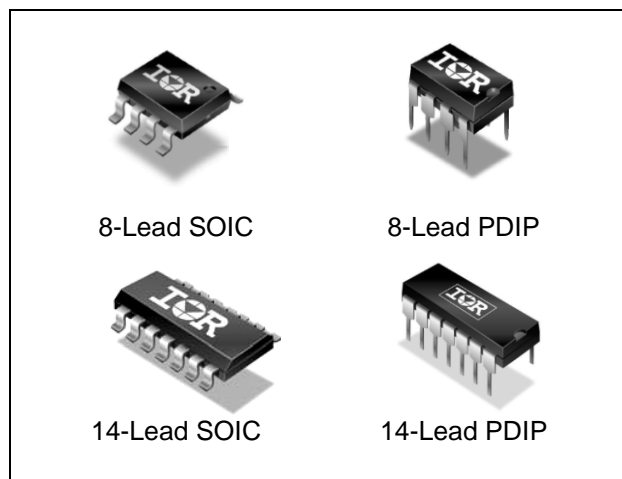

Ordering Information

Base Part Number	Package Type	Standard Pack		Orderable Part Number
		Form	Quantity	
IRS2186SPBF	SO8N	Tube	95	IRS2186SPBF
IRS2186SPBF	SO8N	Tape and Reel	2500	IRS2186STRPBF
IRS21864SPBF	SO14N	Tube	55	IRS21864SPBF
IRS21864SPBF	SO14N	Tape and Reel	2500	IRS21864STRPBF
IRS2186PBF	PDIP8	Tube	50	IRS2186PBF
IRS21864PBF	PDIP14	Tube	25	IRS21864PBF

Table of Contents	Page
Description	1
Ordering Information	1
Typical Connection Diagram	3
Absolute Maximum Ratings	4
Recommended Operating Conditions	4
Dynamic Electrical Characteristics	5
Static Electrical Characteristics	5
Functional Block Diagrams	6
Lead Definitions	7
Lead Assignments	7
Application Information and Additional Details	8
Package Details: PDIP8, SO8N	21
Package Details: PDIP14, SO14N	22
Tape and Reel Details: SO8N	23
Tape and Reel Details: SO14N	24
Part Marking Information	25
Qualification Information	27

Typical Connection Diagram

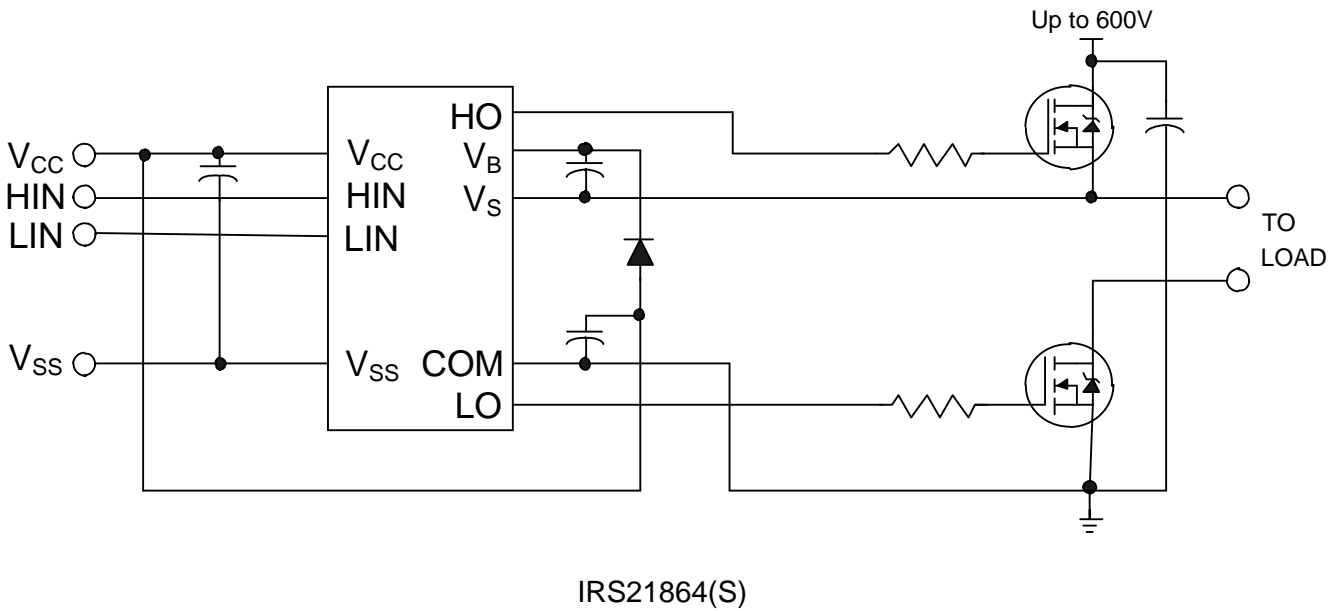
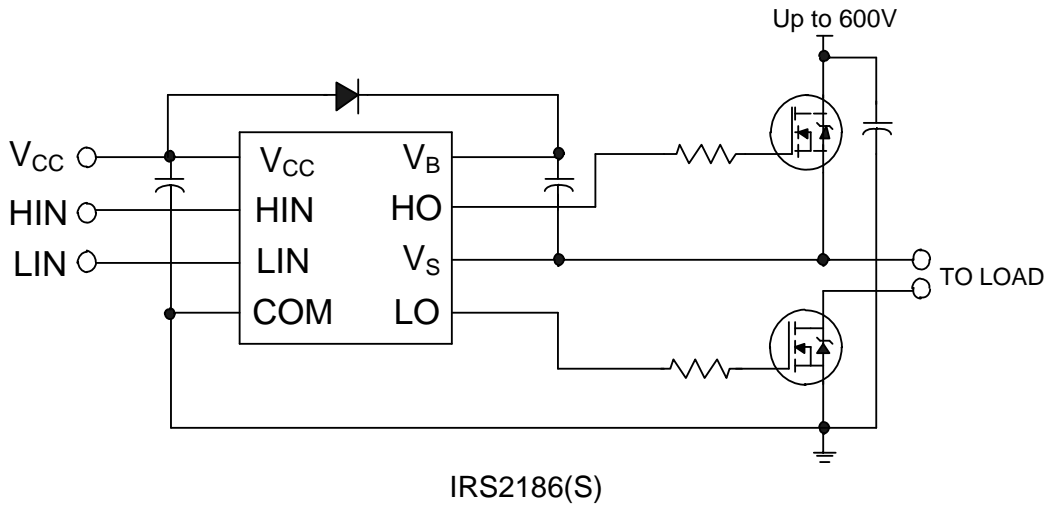

(Refer to Lead Assignments for correct pin configuration). These diagrams show electrical connections only. Please refer to our Application Notes and Design Tips for proper circuit board layout.

Absolute Maximum Ratings

Absolute maximum ratings indicate sustained limits beyond which damage to the device may occur. All voltage parameters are absolute voltages referenced to COM. The thermal resistance and power dissipation ratings are measured under board mounted and still air conditions.

Symbol	Definition	Min.	Max.	Units	
V_B	High side floating absolute voltage	-0.3	620 [†]	V	
V_S	High side floating supply offset voltage	$V_B - 20$	$V_B + 0.3$		
V_{HO}	High side floating output voltage	$V_S - 0.3$	$V_B + 0.3$		
V_{CC}	Low side and logic fixed supply voltage	-0.3	20 [†]		
V_{LO}	Low side output voltage	-0.3	$V_{CC} + 0.3$		
V_{IN}	Logic input voltage (HIN & LIN)	$V_{SS} - 0.3$	$V_{CC} + 0.3$		
V_{SS}	Logic ground (IRS21864)	$V_{CC} - 20$	$V_{CC} + 0.3$		
dV_S/dt	Allowable offset supply voltage transient	—	50		V/ns
P_D	Package power dissipation @ $T_A \leq +25^\circ\text{C}$	8 lead PDIP	—	1	W
		8 lead SOIC	—	0.625	
		14 lead PDIP	—	1.6	
		14 lead SOIC	—	1	
R_{thJA}	Thermal resistance, junction to ambient	8 lead PDIP	—	125	°C/W
		8 lead SOIC	—	200	
		14 lead PDIP	—	75	
		14 lead SOIC	—	120	
T_J	Junction temperature	—	150	°C	
T_S	Storage temperature	-50	150		
T_L	Lead temperature (soldering, 10 seconds)	—	300		

Recommended Operating Conditions

The input/output logic timing diagram is shown in figure 1. For proper operation the device should be used within the recommended conditions. The V_S and V_{SS} offset rating is tested with all supplies biased at 15 V differential.

Symbol	Definition	Min.	Max.	Units
V_B	High side floating absolute voltage	$V_S + 10$	$V_S + 20$	V
V_S	High side floating supply offset voltage	††	600	
V_{HO}	High side floating output voltage	V_S	V_B	
V_{CC}	Low side and logic fixed supply voltage	10	20	
V_{LO}	Low side output voltage	0	V_{CC}	
V_{IN}	Logic input voltage (HIN & LIN)	V_{SS}	V_{CC}	
V_{SS}	Logic ground (IRS21864)	-5	5	
T_A	Ambient temperature	-40	125	°C

† All supplies are fully tested at 25 V and an internal 20 V clamp exists for each supply

†† Logic operational for V_S of -5 V to 600 V. Logic state held for V_S of -5 V to $-V_{BS}$ (Please refer to the Design Tip DT97-3 for more details)

Dynamic Electrical Characteristics

V_{BIAS} (V_{CC} , V_{BS}) = 15 V, V_{SS} = COM, C_L = 1000 pF and T_A = 25 °C unless otherwise specified.

Symbol	Definition	Min.	Typ.	Max.	Units	Test Conditions
t_{on}	Turn-on propagation delay	—	170	250	ns	$V_S = 0$ V
t_{off}	Turn-off propagation delay	—	170	250		$V_S = 0$ V or 600 V
t_r	Turn-on rise time	—	22	38		$V_S = 0$ V
t_f	Turn-off fall time	—	18	30		
MT	Delay matching, HS & LS turn on/off	—	0	35		

Static Electrical Characteristics

V_{BIAS} (V_{CC} , V_{BS}) = 15 V, V_{SS} = COM, and T_A = 25 °C unless otherwise specified. The V_{IL} , V_{IH} , and I_{IN} parameters are referenced to V_{SS}/COM and are applicable to the respective input leads HIN and LIN. The V_O , I_O , and R_{ON} parameters are referenced to COM and are applicable to the respective output leads: HO and LO.

Symbol	Definition	Min.	Typ.	Max.	Units	Test Conditions
V_{IH}	Logic "1" input voltage	2.5	—	—	V	$V_{CC} = 10$ V to 20 V
V_{IL}	Logic "0" input voltage	—	—	0.8		
V_{OH}	High level output voltage, $V_{BIAS} - V_O$	—	—	1.4		
V_{OL}	Low level output voltage, V_O	—	—	0.15		
I_{LK}	Offset supply leakage current	—	—	50	μ A	$V_B = V_S = 600$ V
I_{QBS}	Quiescent V_{BS} supply current	20	60	150		$V_{IN} = 0$ V or 5 V
I_{QCC}	Quiescent V_{CC} supply current	50	120	240		
I_{IN+}	Logic "1" input bias current	—	25	60		
I_{IN-}	Logic "0" input bias current	—	—	5		$V_{IN} = 0$ V
V_{CCUV+} V_{BSUV+}	V_{CC} and V_{BS} supply undervoltage positive going threshold	8	8.9	9.8	V	
V_{CCUV-} V_{BSUV-}	V_{CC} and V_{BS} supply undervoltage negative going threshold	7.4	8.2	9		
V_{CCUVH} V_{BSUVH}	Hysteresis	0.3	0.7	—		
I_{O+}	Output high short circuit pulsed current	2	4	—	A	$V_O = 0$ V, $PW \leq 10$ μ s
I_{O-}	Output low short circuit pulsed current	2	4	—		$V_O = 15$ V, $PW \leq 10$ μ s

Functional Block Diagram

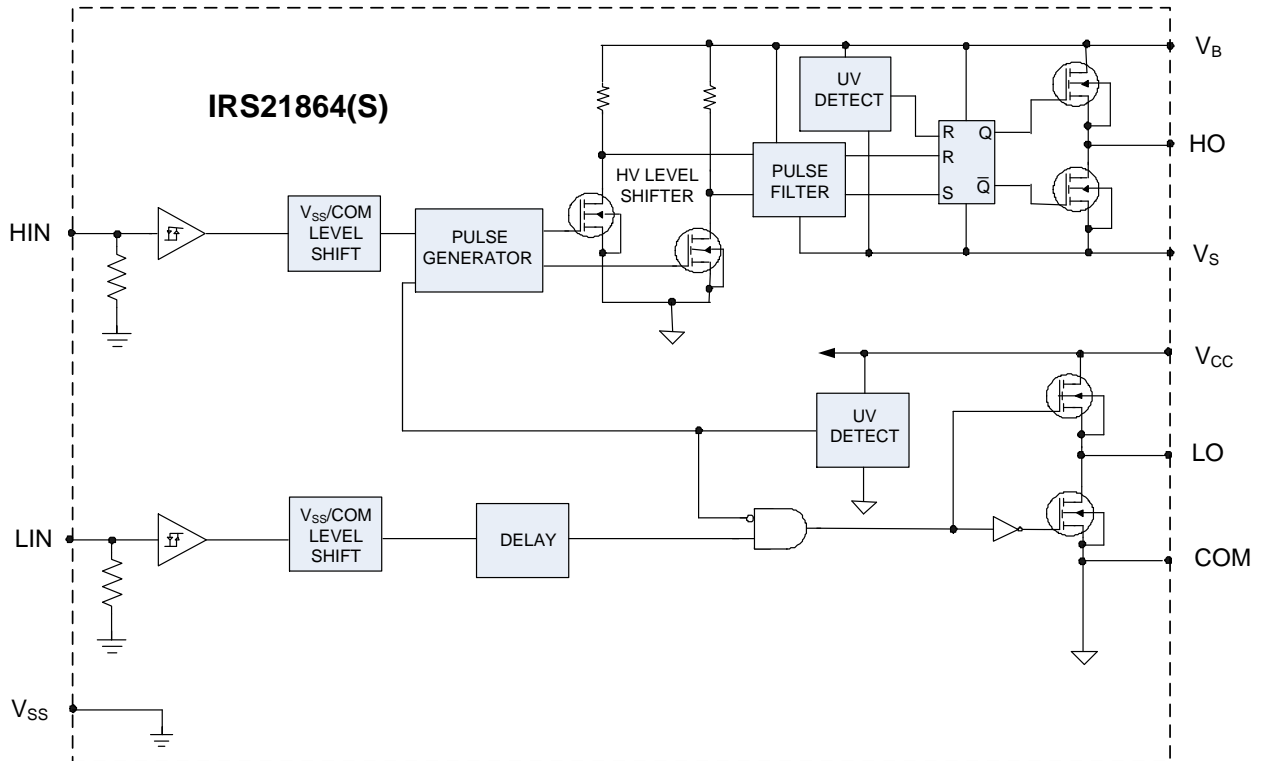
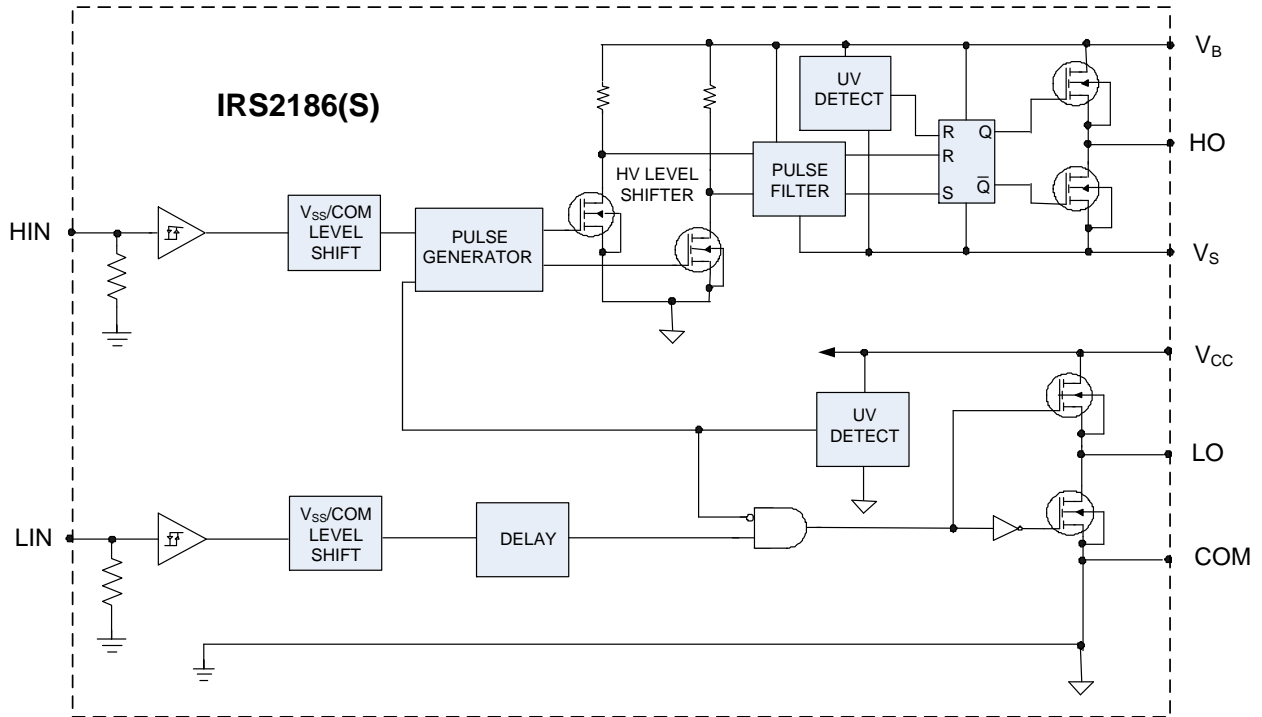

Lead Definitions

Symbol	Description
HIN	Logic input for high side gate driver output (HO), in phase
LIN	Logic input for low side gate driver output (LO), in phase
V _{SS}	Logic ground (IRS21864)
V _B	High side floating supply
HO	High side gate drive output
V _S	High side floating supply return
V _{CC}	Low side and logic fixed supply
LO	Low side gate drive output
COM	Low side return

Lead Assignments

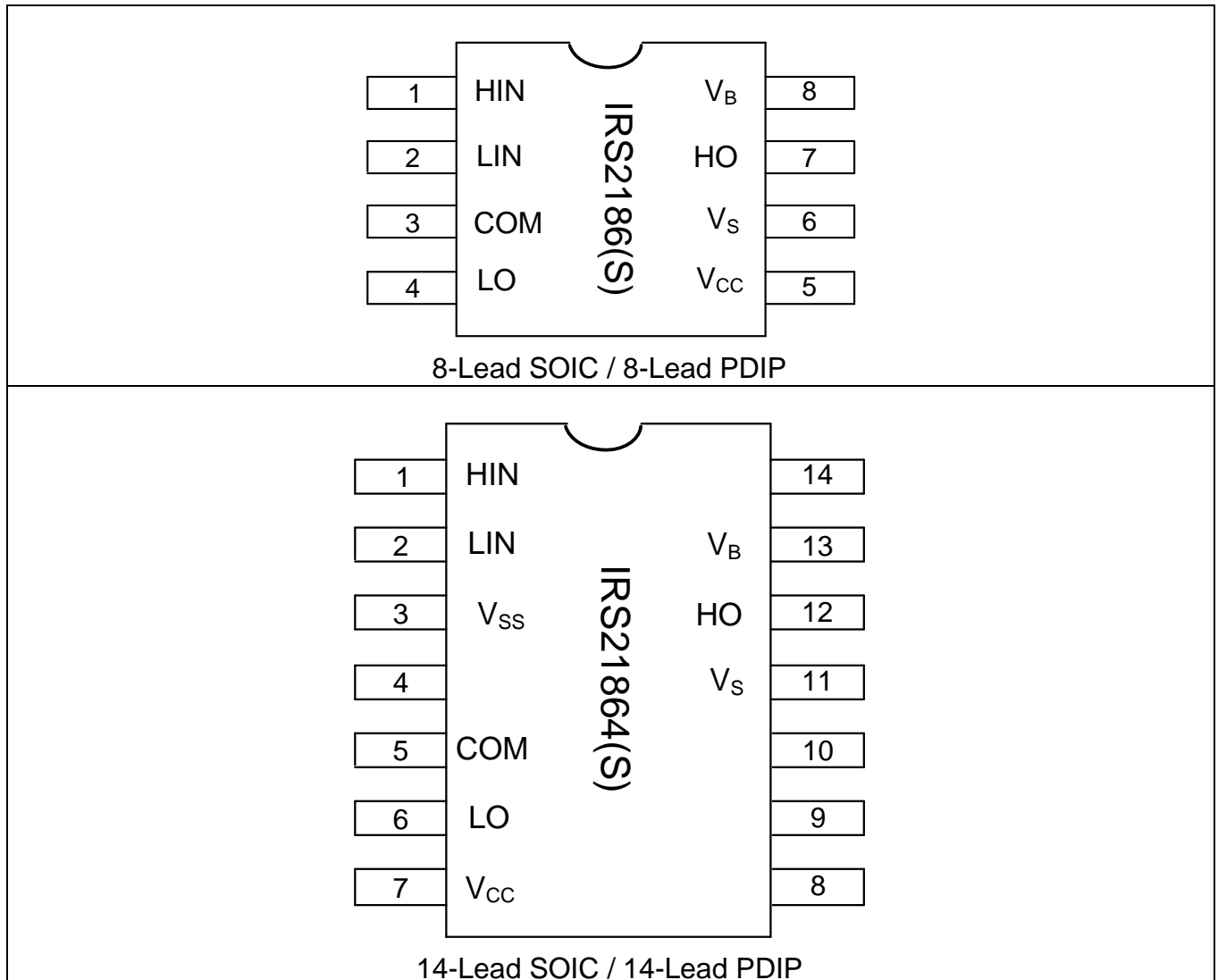

Application Information and Additional Details

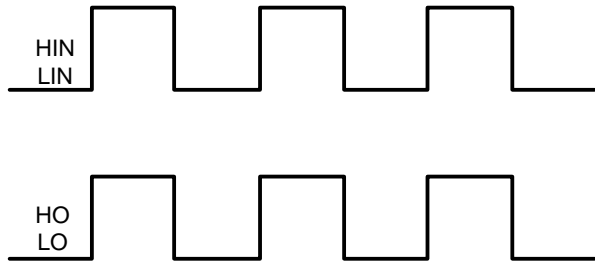

Figure 1. Input/Output Timing Diagram

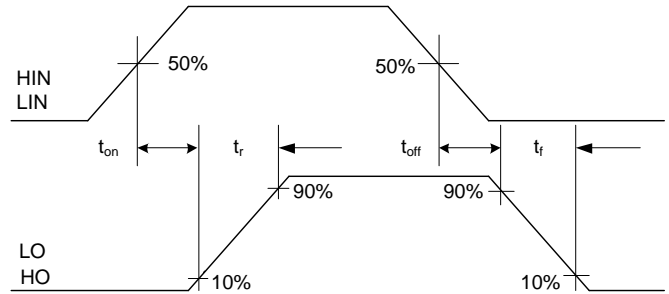

Figure 2. Switching Time Waveform Definitions

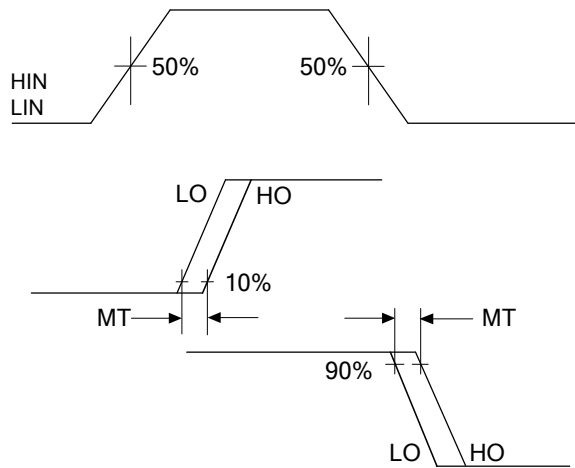

Figure 3. Delay Matching Waveform Definitions

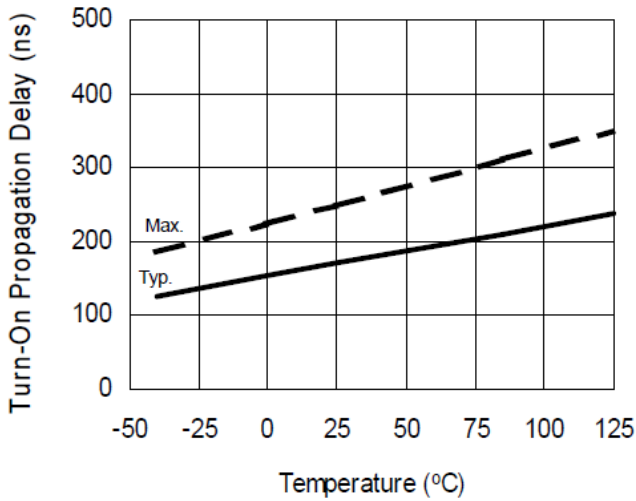

Figure 4A. Turn-On Propagation Delay vs. Temperature

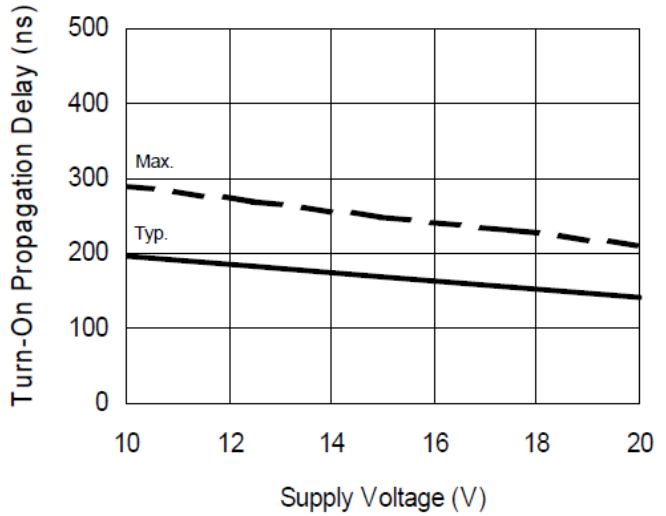

Figure 4B. Turn-on Propagation Delay vs. Supply Voltage

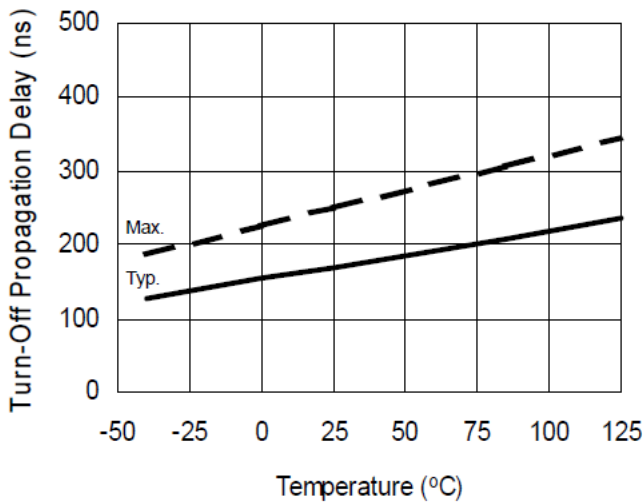

Figure 5A. Turn-Off Propagation Delay vs. Temperature

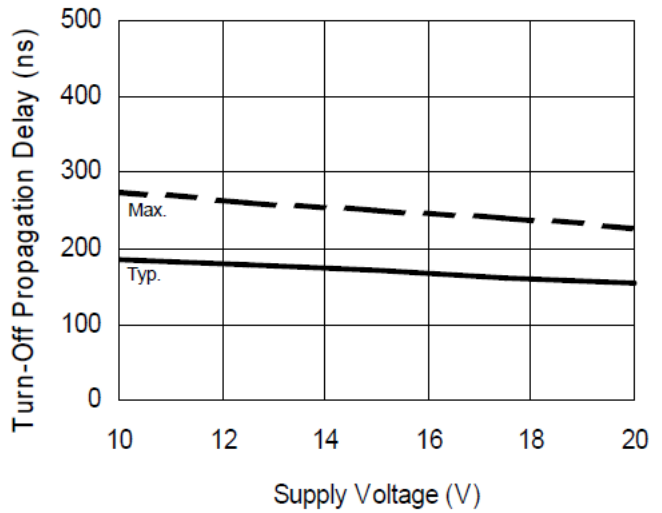
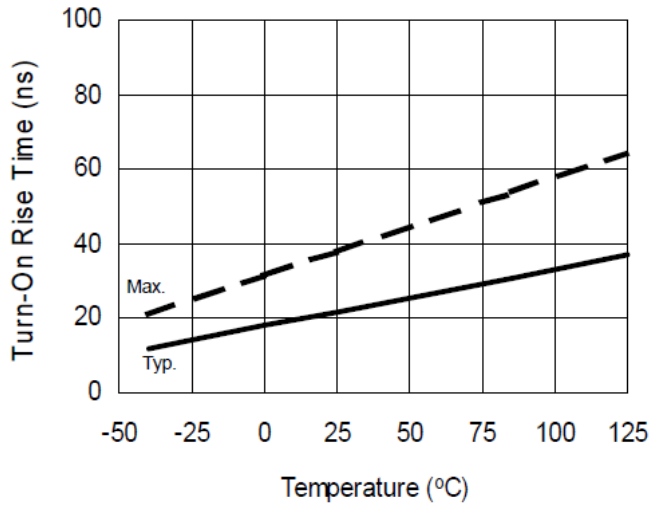

Figure 5B. Turn-Off Propagation Delay vs. Supply Voltage



6A. Turn-On Rise Time vs. Temperature

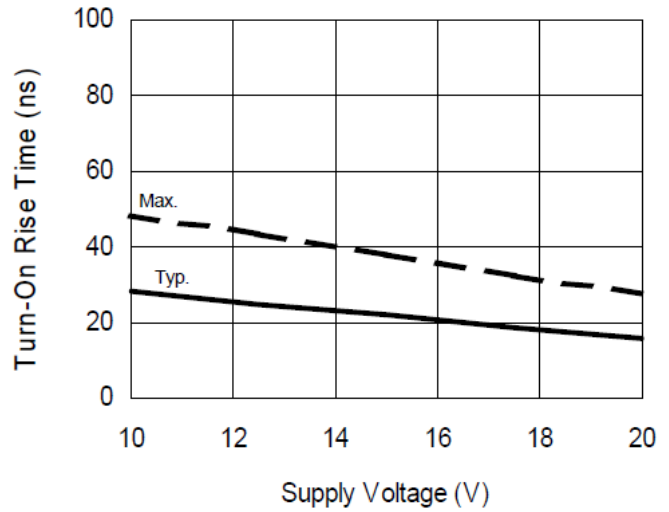

Figure 6B. Turn-On Rise Time vs. Supply Voltage

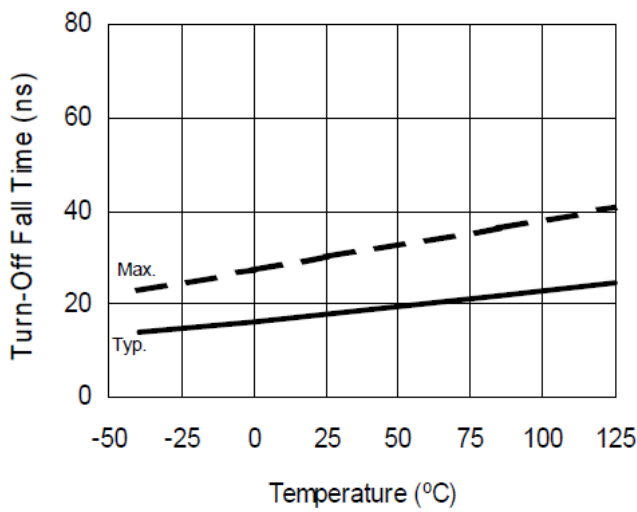

Figure 7A. Turn-Off Fall Time vs. Temperature

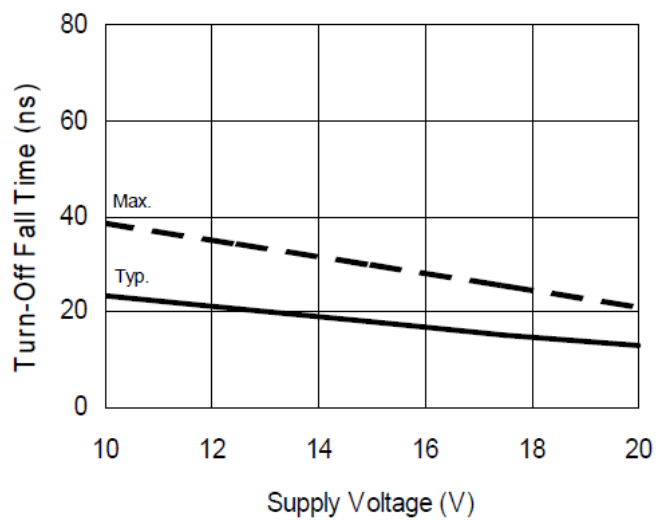

Figure 7B. Turn-Off Fall Time vs. Supply Voltage

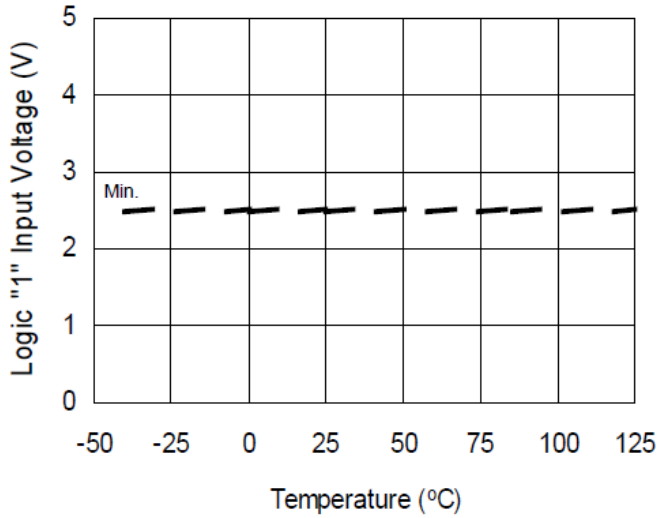

Figure 8A. Logic "1" Input Voltage vs. Temperature

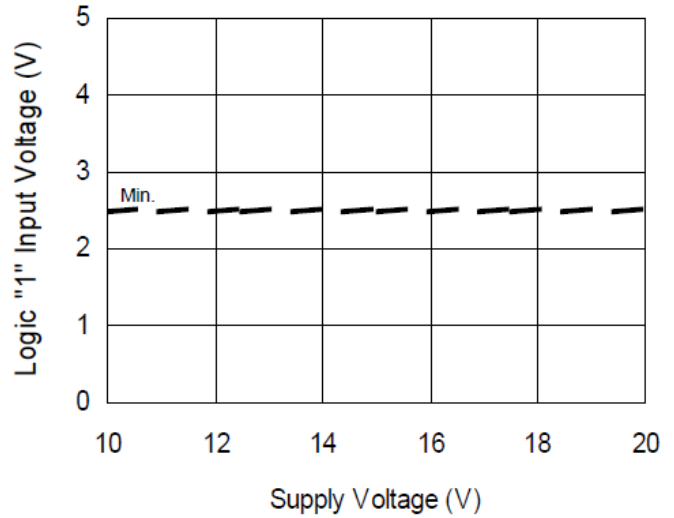

Figure 8B. Logic "1" Input Voltage vs. Supply Voltage

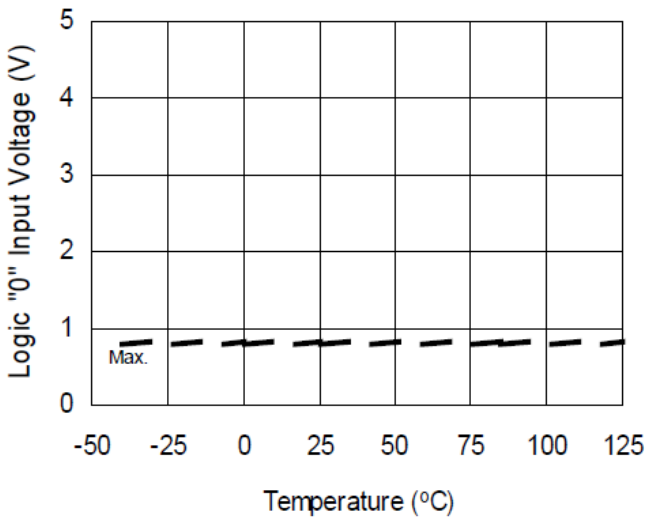

Figure 9A. Logic "0" Input Voltage vs. Temperature

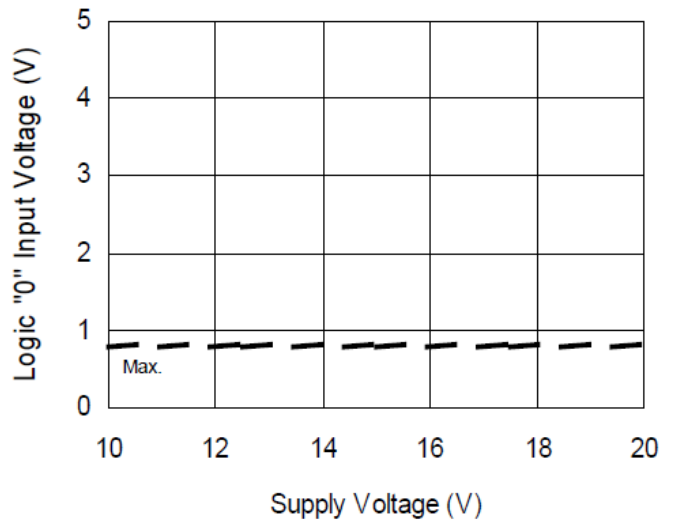

Figure 9B. Logic "0" Input Voltage vs. Supply Voltage

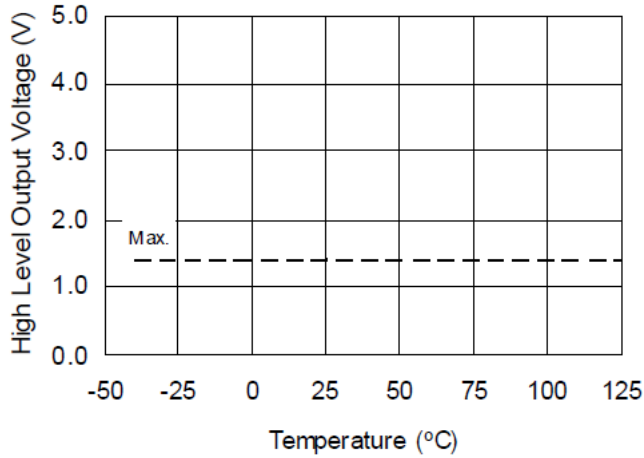

Figure 10A. High Level Output Voltage vs. Temperature (Io = 0mA)

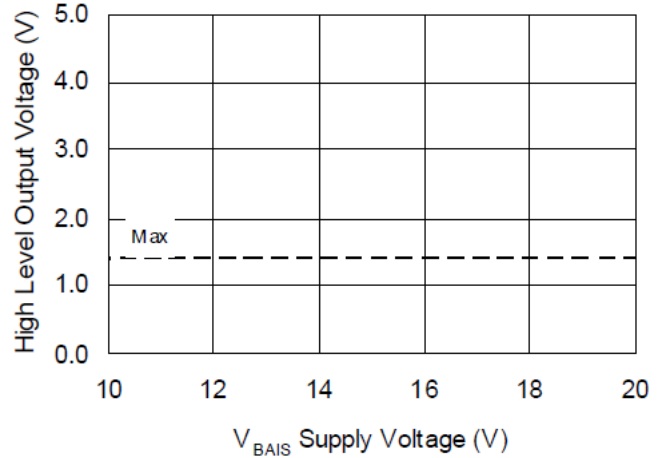

Figure 10B. High Level Output Voltage vs. Supply Voltage (Io = 0mA)

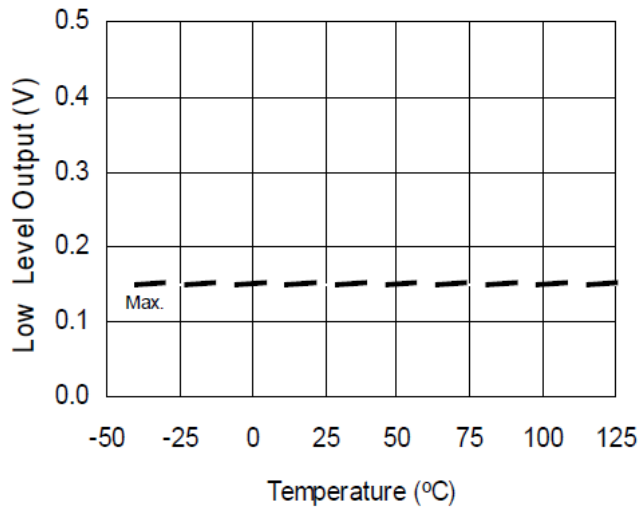

Figure 11A. Low Level Output vs. Temperature

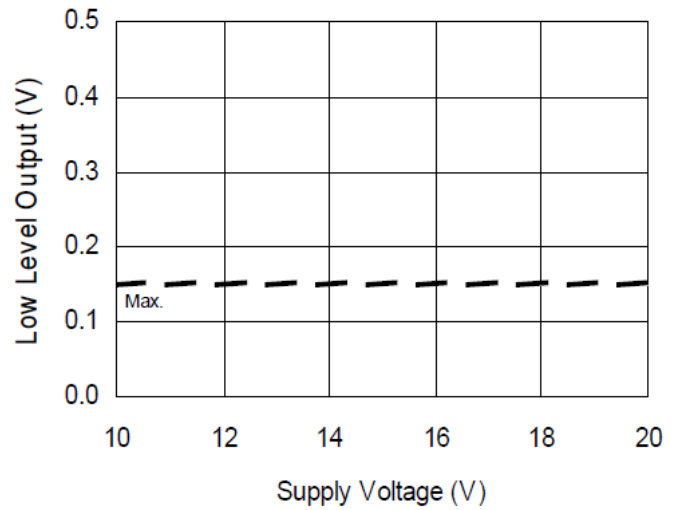

Figure 11B. Low Level Output vs. Supply Voltage

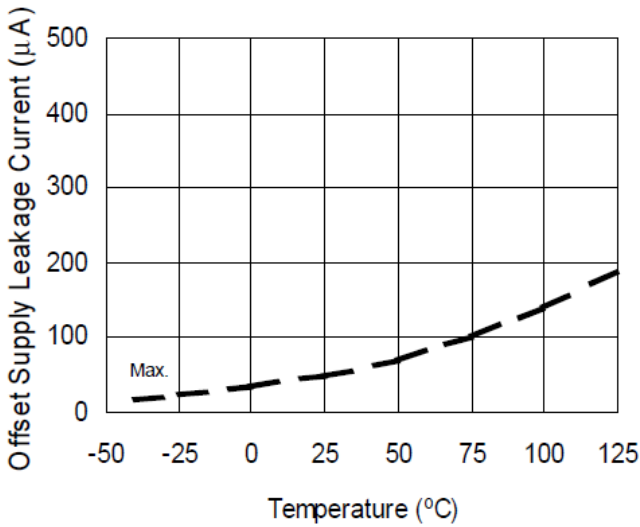

Figure 12A. Offset Supply Leakage Current

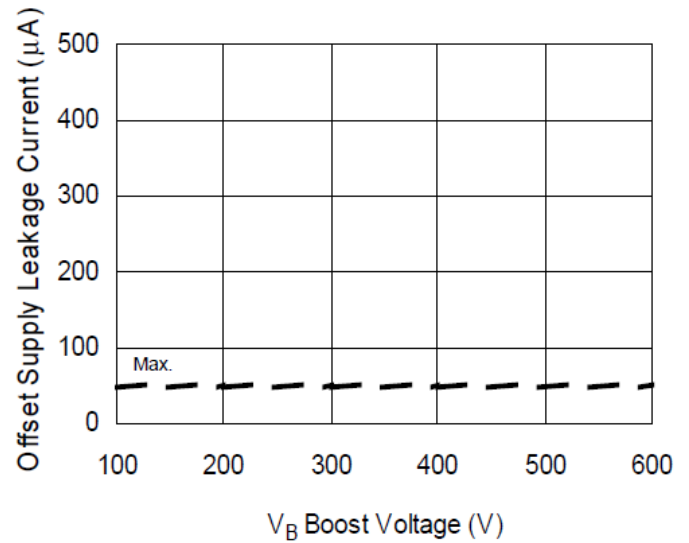

Figure 12B. Offset Supply Leakage Current vs. V_B Boost Voltage

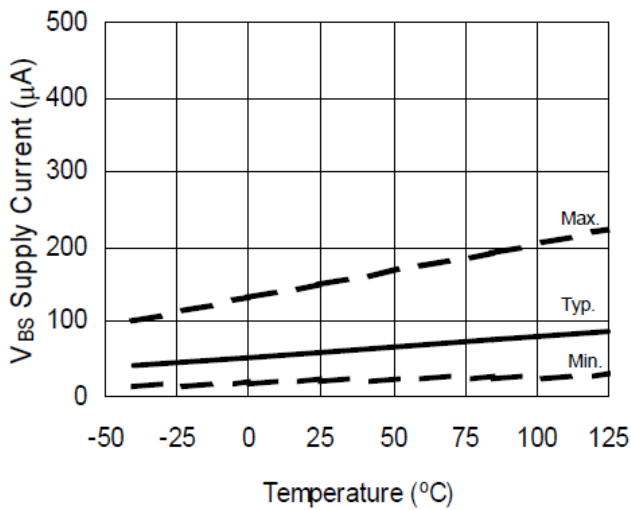

Figure 13A. V_{BS} Supply Current vs. Temperature

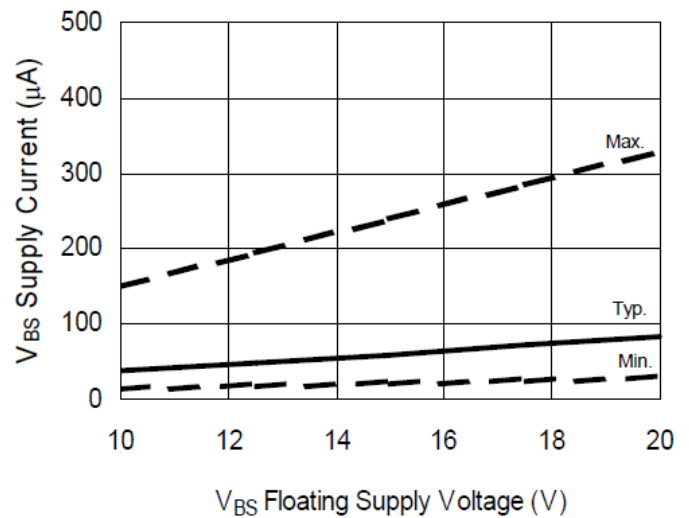

Figure 13B. V_{BS} Supply Current vs. V_{BS} Floating Supply Voltage

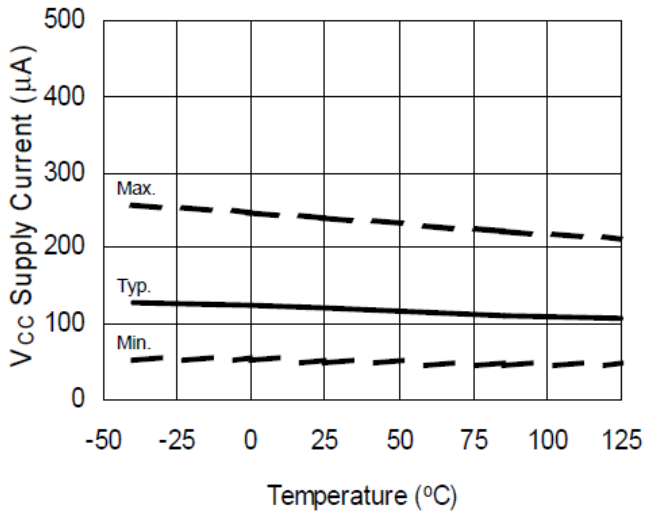

Figure 14A. V_{CC} Supply Current vs. Temperature

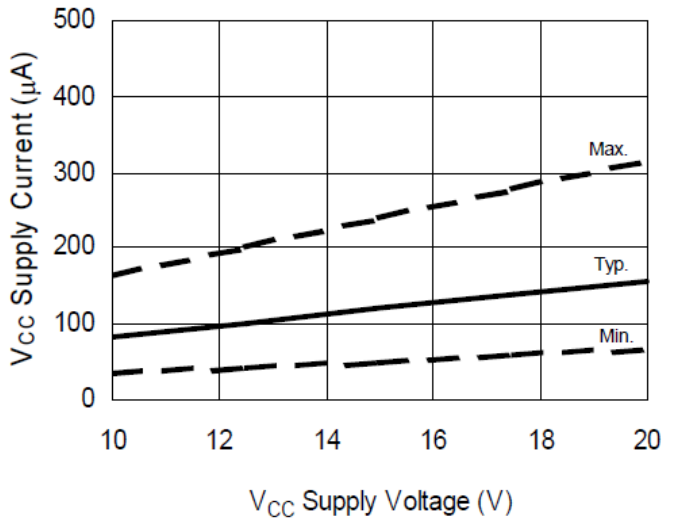

Figure 14B. V_{CC} Supply Current vs. Supply Voltage

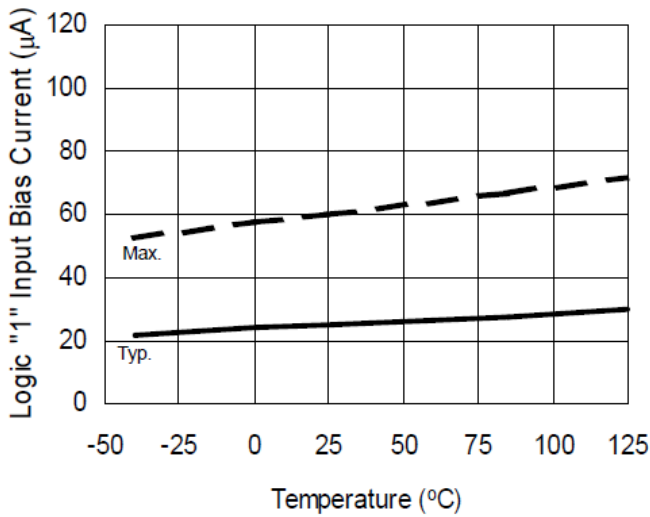

Figure 15A. Logic "1" Input Bias Current vs. Temperature

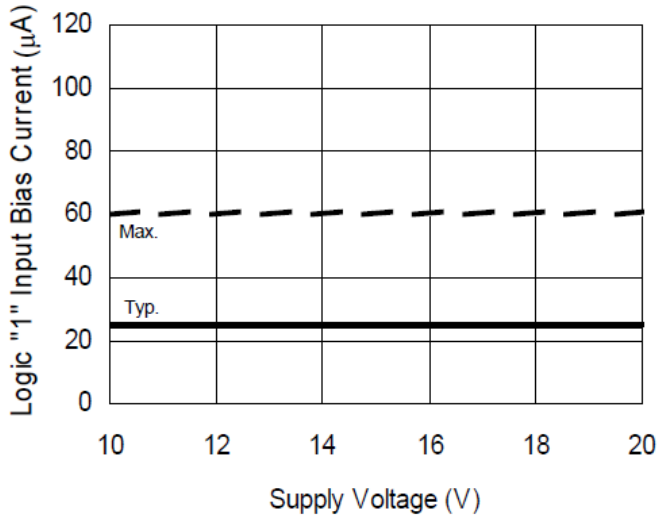

Figure 15B. Logic "1" Input Bias Current vs. Supply Voltage

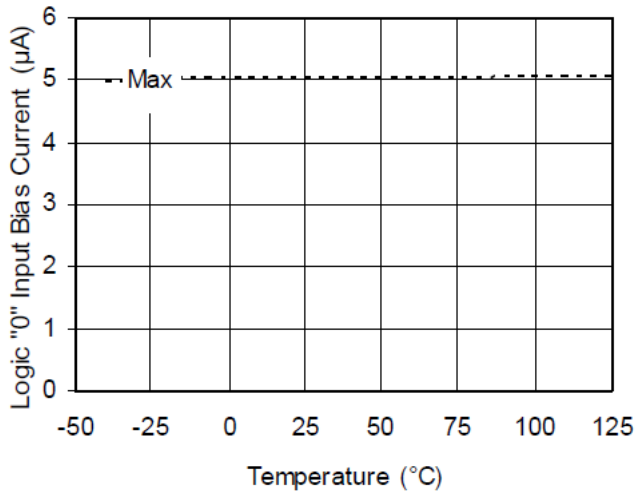

Figure 16A. Logic "0" Input Bias Current vs. Temperature

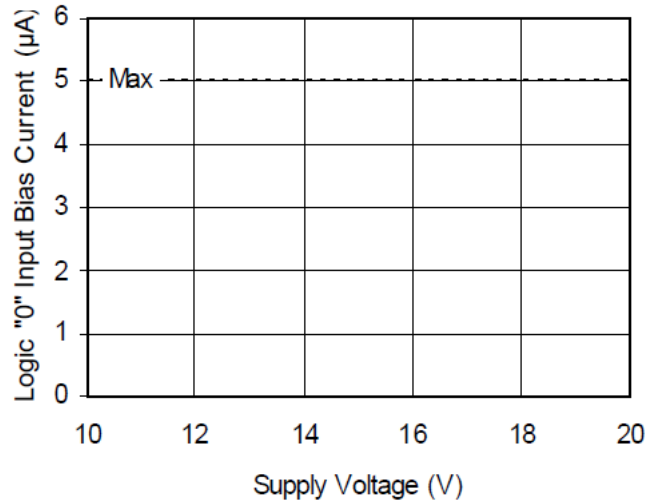

Figure 16B. Logic "0" Input Bias Current vs. Voltage

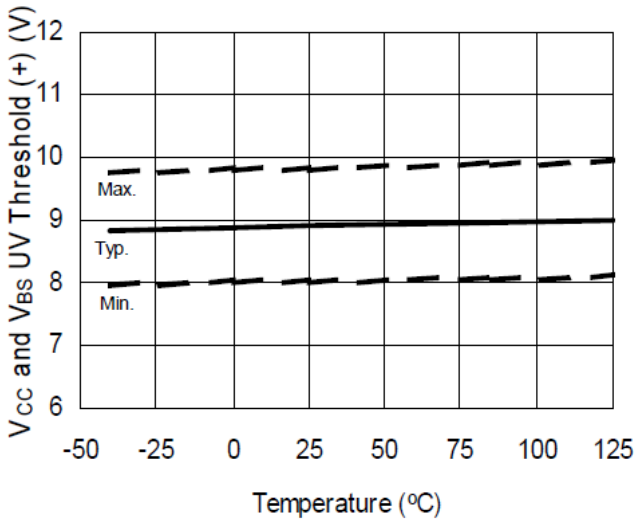

Figure 17. V_{CC} and V_{BS} Undervoltage Threshold (+) vs. Temperature

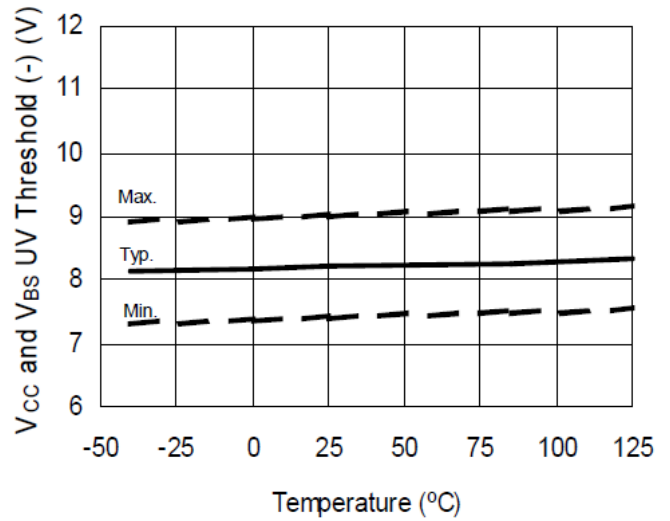

Figure 18. V_{CC} and V_{BS} Undervoltage Threshold (-) vs. Temperature

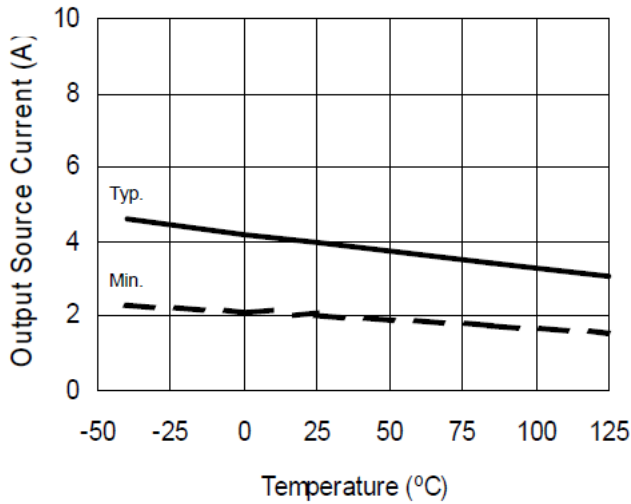

Figure 19A. Output Source Current vs. Temperature

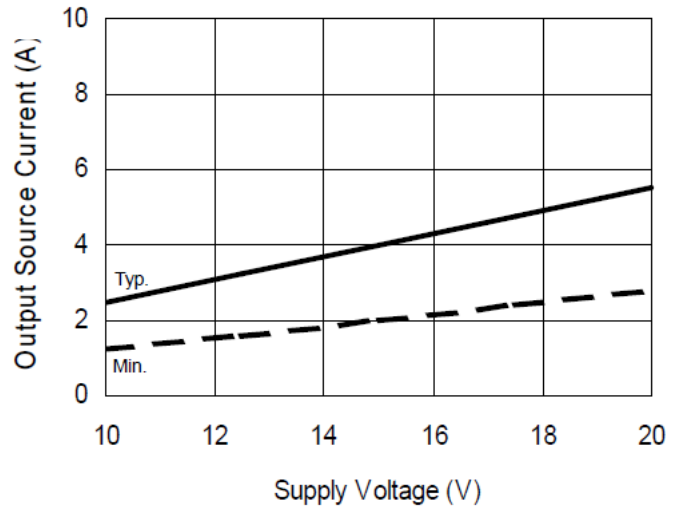

Figure 19B. Output Source Current vs. Supply Voltage

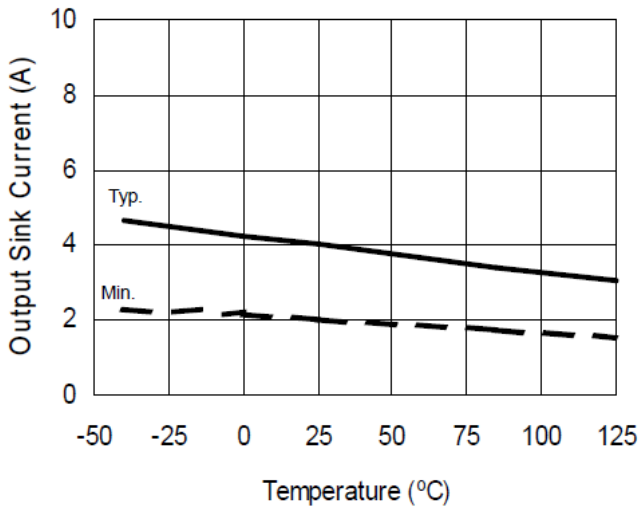

Figure 20A. Output Sink Current vs. Temperature

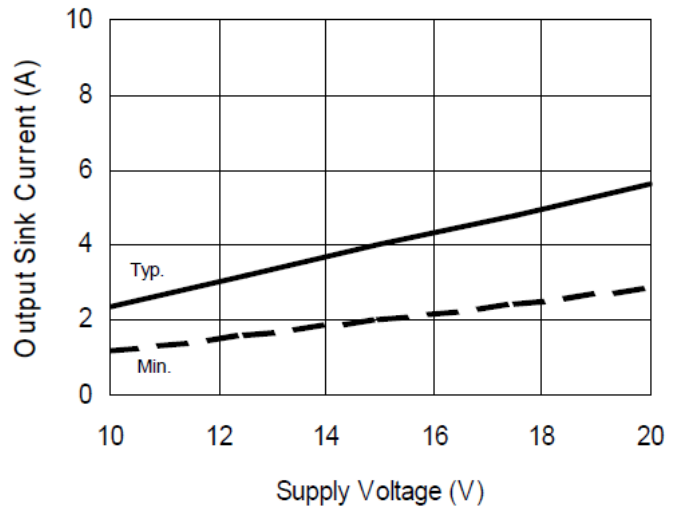

Figure 10B. Output Sink Current vs. Supply Voltage

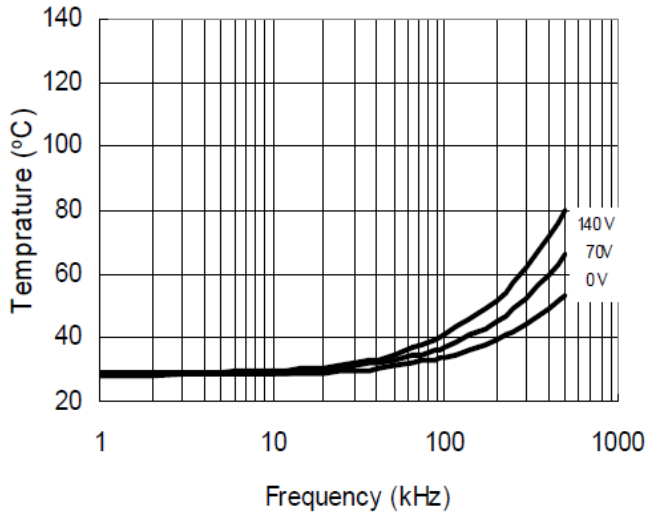

Figure 21. IRS2186 vs. Frequency (IRFBC20)
 $R_{gate} = 33\Omega, V_{CC} = 15V$

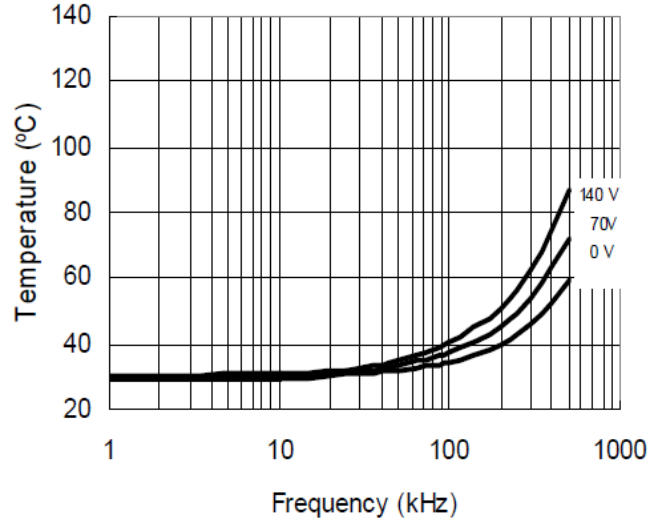

Figure 22. IRS2186 vs. Frequency (IRFBC30)
 $R_{gate} = 22\Omega, V_{CC} = 15V$

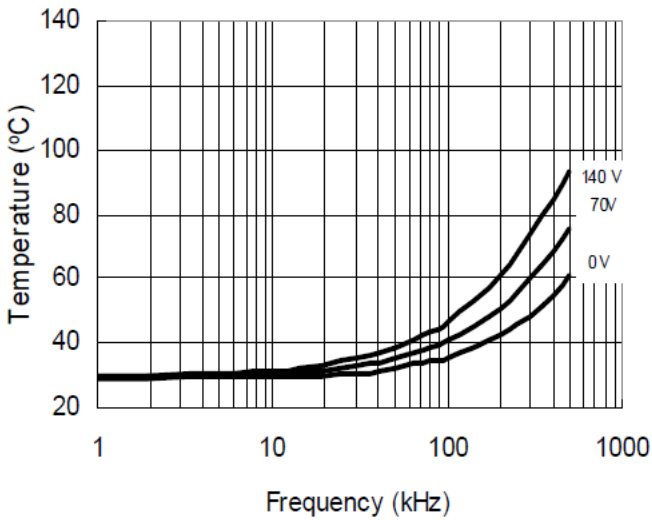

Figure 23. IRS2186 vs. Frequency (IRFBC40)
 $R_{gate} = 15\Omega, V_{CC} = 15V$

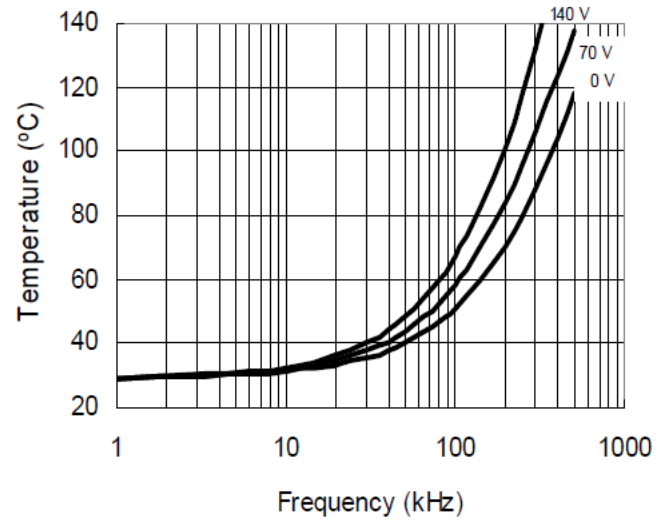

Figure 24. IRS2186 vs. Frequency (IRFPE50)
 $R_{gate} = 10\Omega, V_{CC} = 15V$

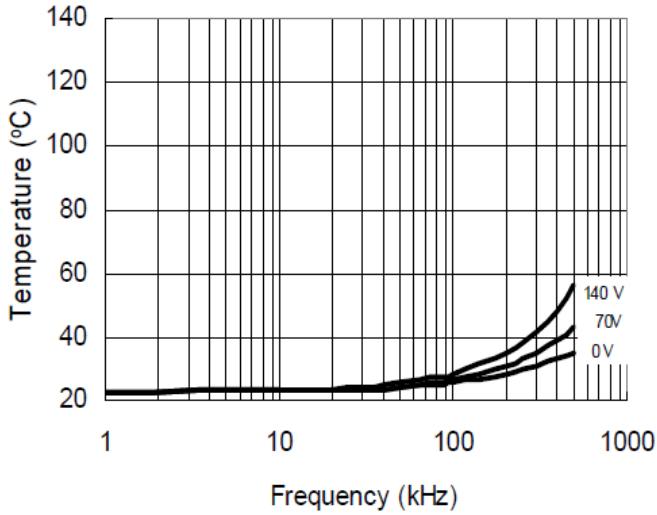

Figure 25. IRS21864 vs. Frequency (IRFBC20)
 $R_{gate} = 33\Omega, V_{CC} = 15V$

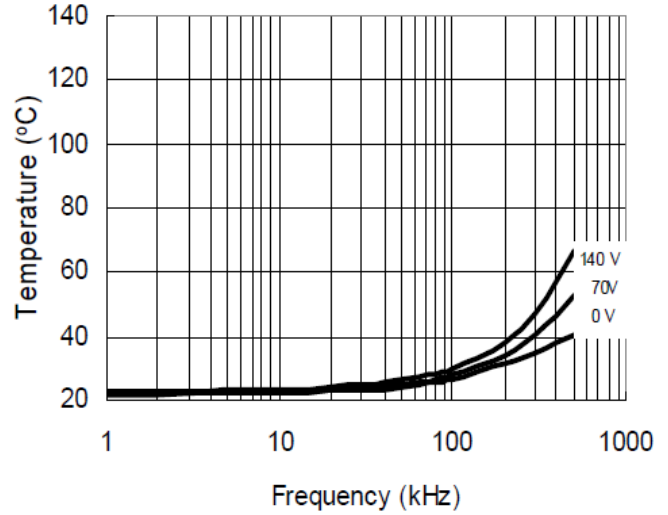

Figure 26. IRS21864 vs. Frequency (IRFBC30)
 $R_{gate} = 22\Omega, V_{CC} = 15V$

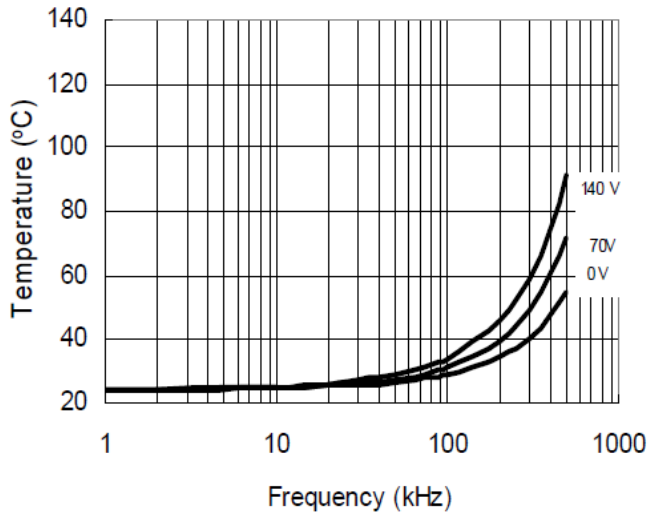

Figure 27. IRS21864 vs. Frequency (IRFBC40)
 $R_{gate} = 15\Omega, V_{CC} = 15V$

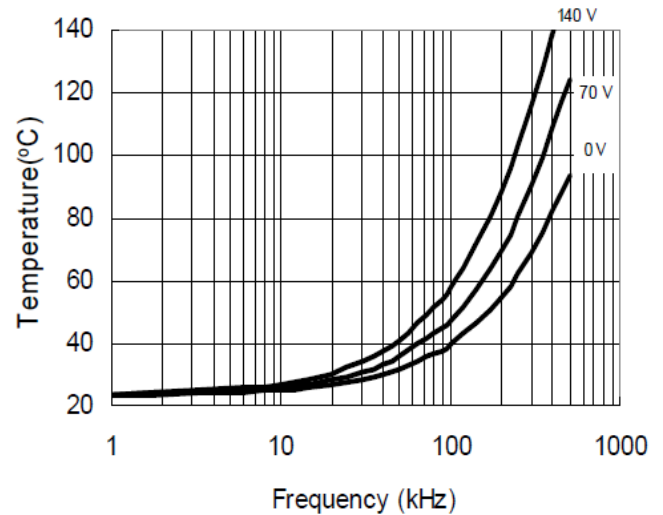

Figure 28. IRS21864 vs. Frequency (IRFPE50)
 $R_{gate} = 10\Omega, V_{CC} = 15V$

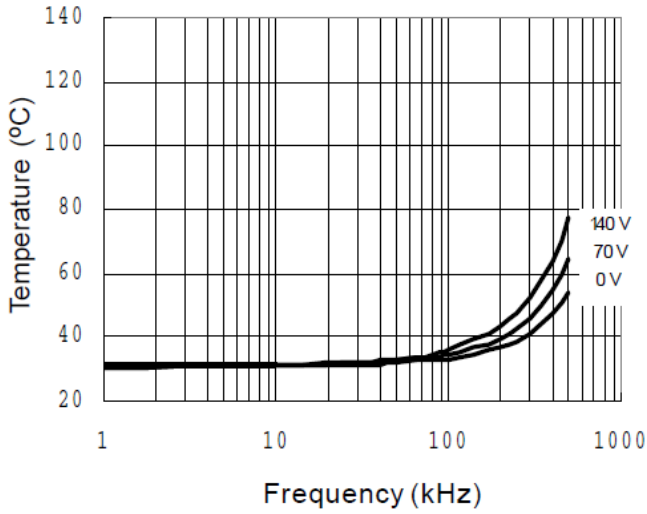

Figure 29. IRS2186S vs. Frequency (IRFBC20)
 $R_{gate} = 33\Omega, V_{CC} = 15V$

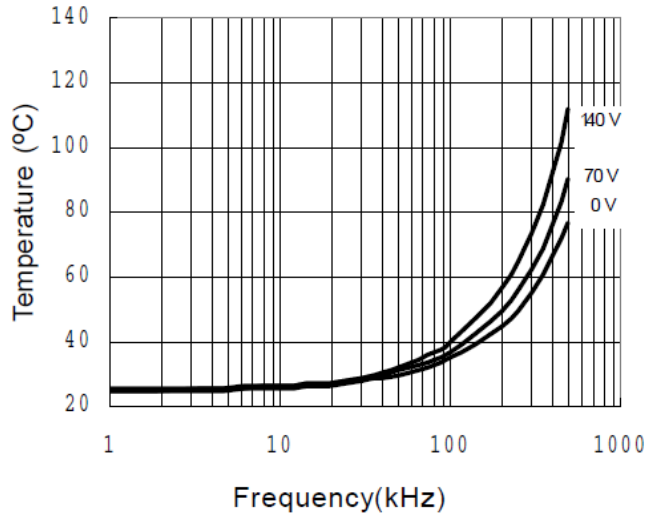

Figure 30. IRS2186S vs. Frequency (IRFBC30)
 $R_{gate} = 22\Omega, V_{CC} = 15V$

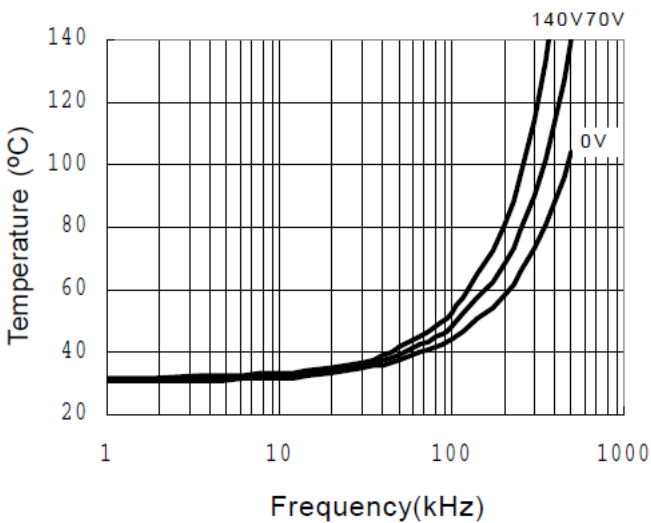

Figure 31. IRS2186S vs. Frequency (IRFBC40)
 $R_{gate} = 15\Omega, V_{CC} = 15V$

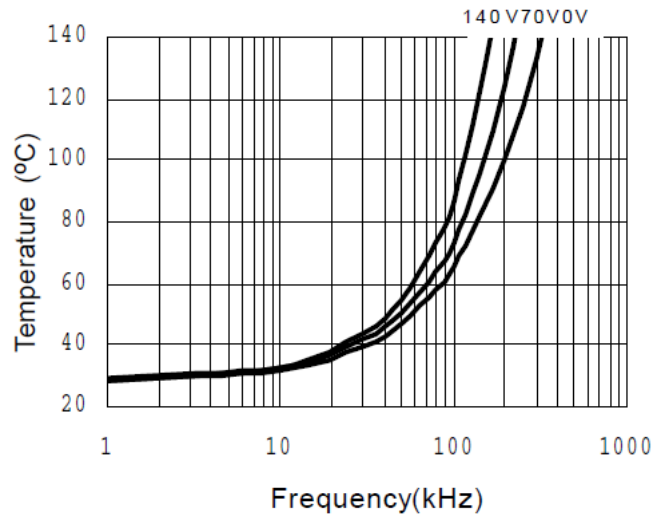

Figure 32. IRS2186S vs. Frequency (IRFPE50)
 $R_{gate} = 10\Omega, V_{CC} = 15V$

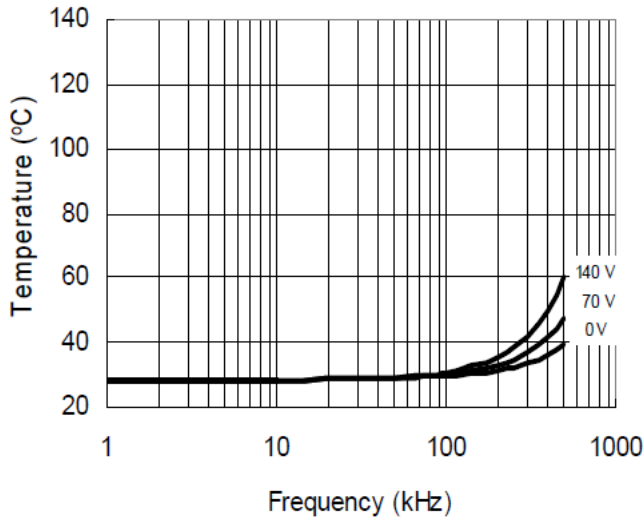

Figure 33. IRS21864S vs. Frequency (IRFBC20)
 $R_{gate} = 33\Omega, V_{CC} = 15V$

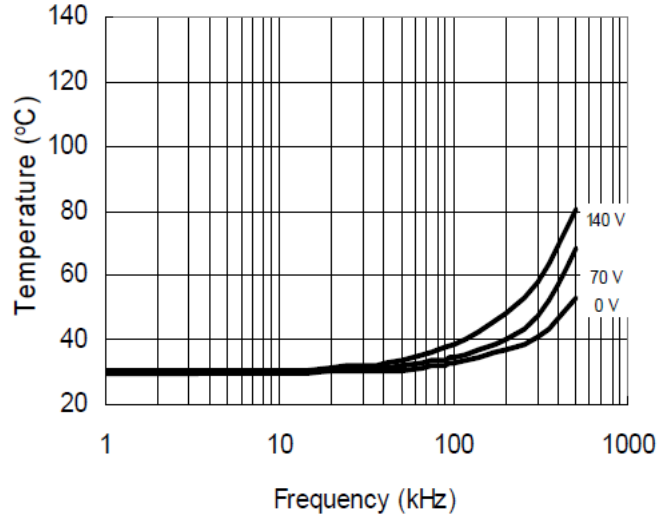

Figure 34. IRS21864S vs. Frequency (IRFBC30)
 $R_{gate} = 22\Omega, V_{CC} = 15V$

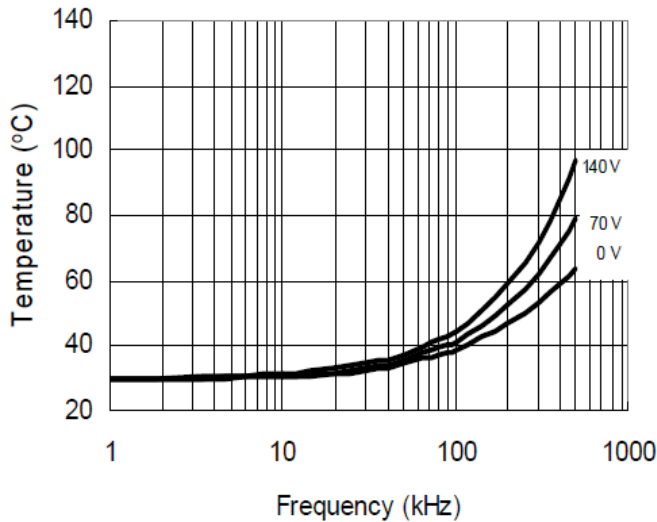

Figure 35. IRS21864S vs. Frequency (IRFBC40)
 $R_{gate} = 15\Omega, V_{CC} = 15V$

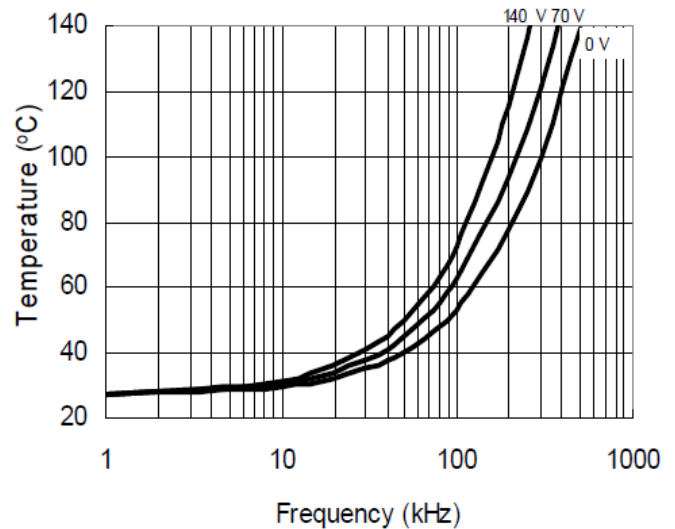
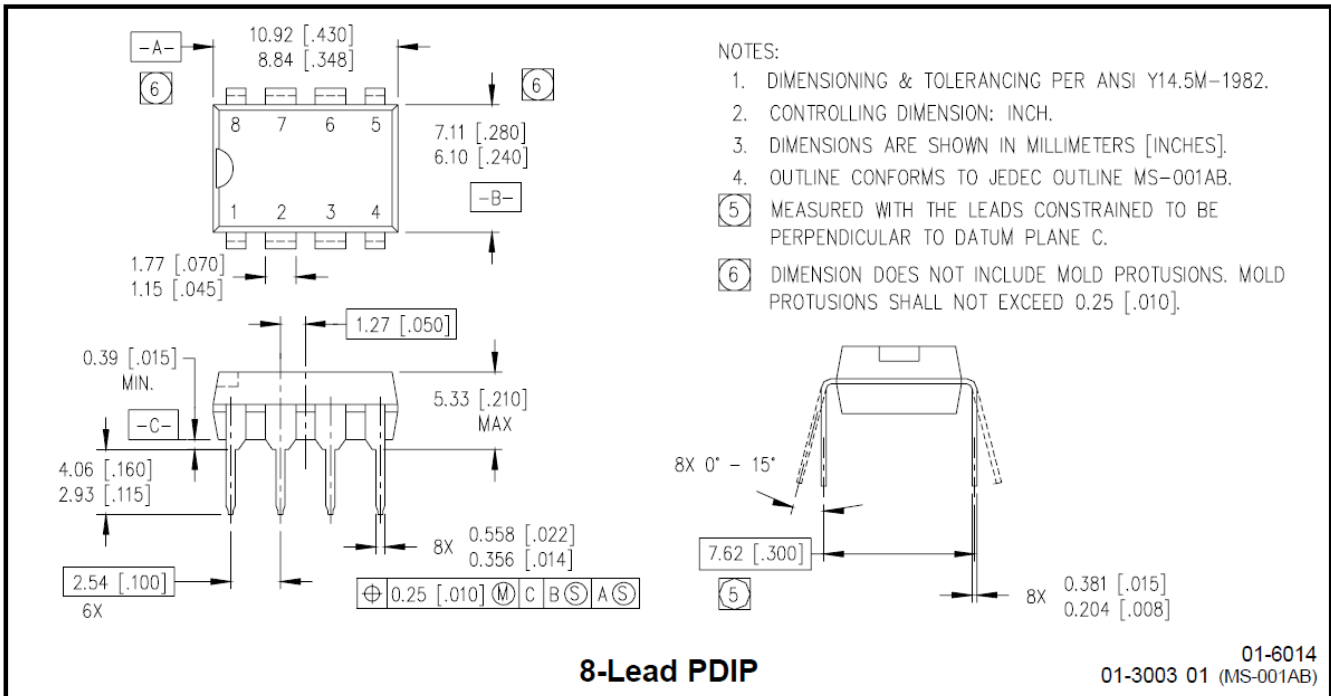
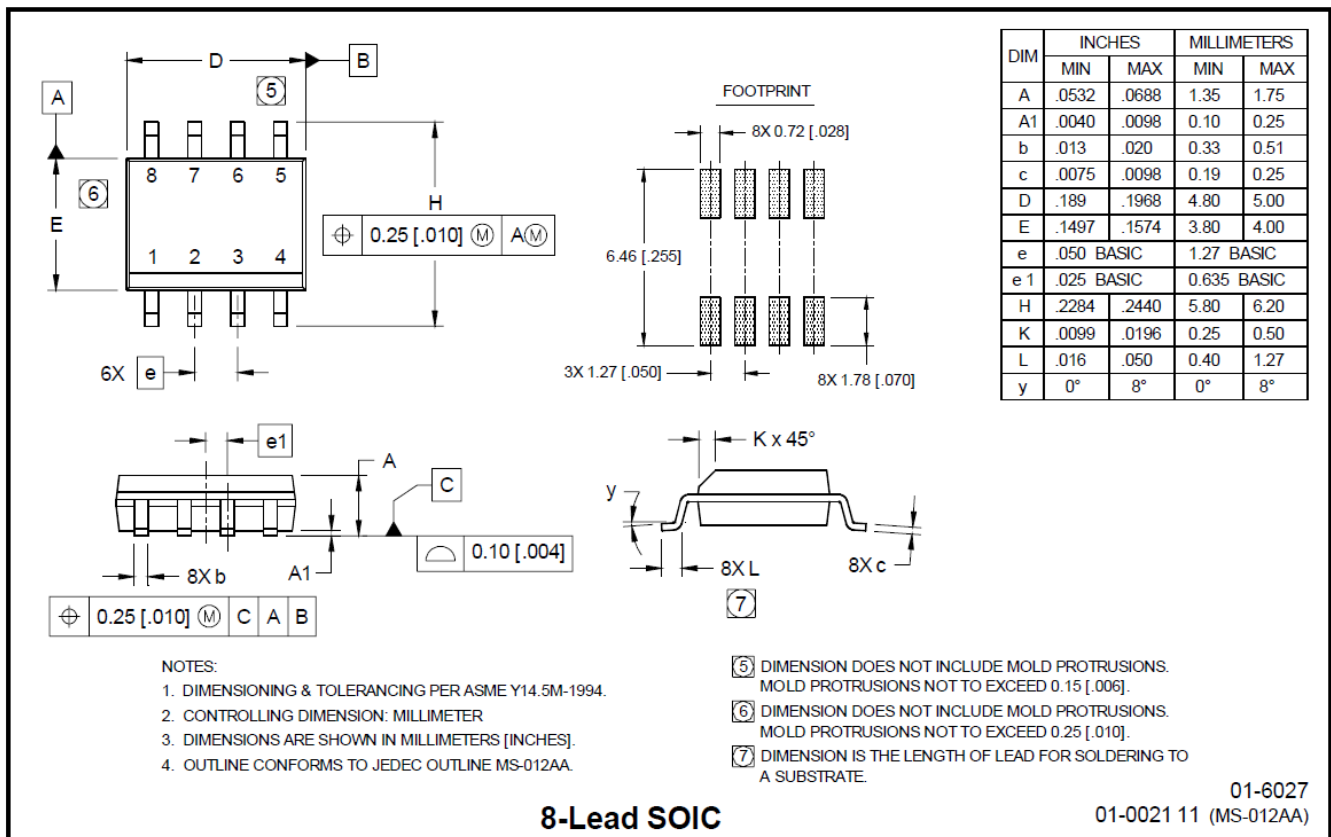
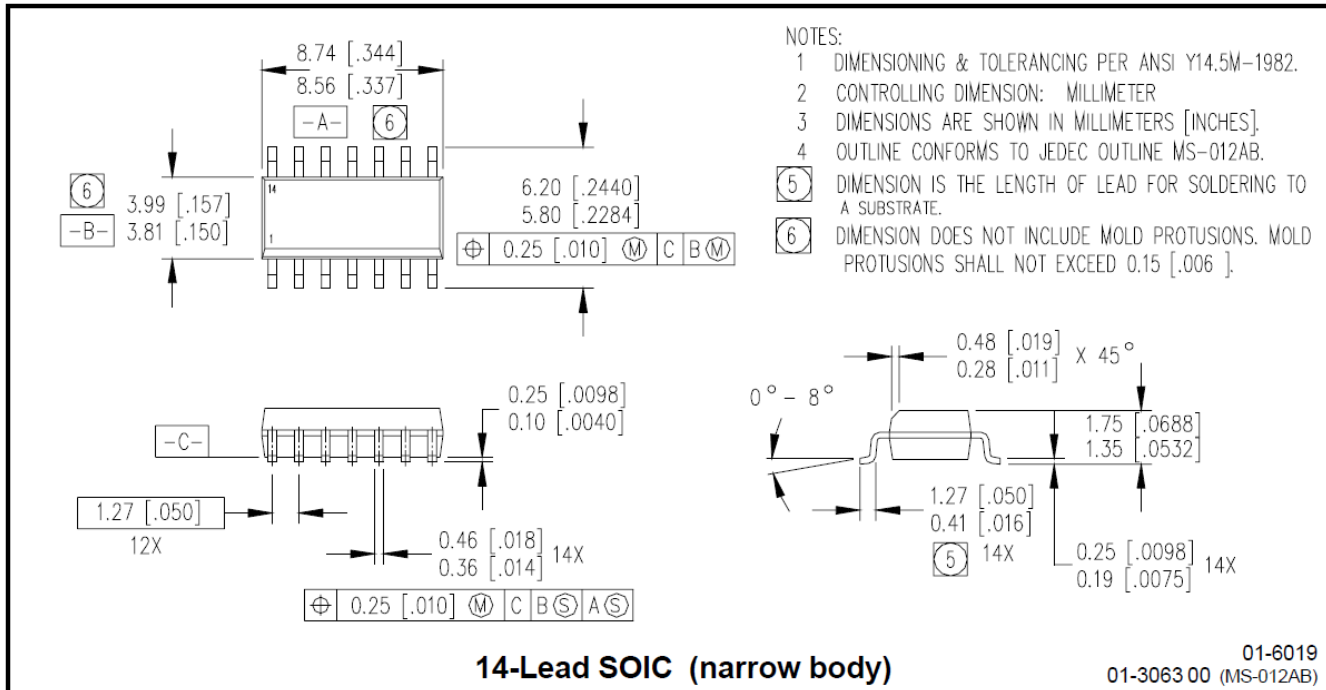
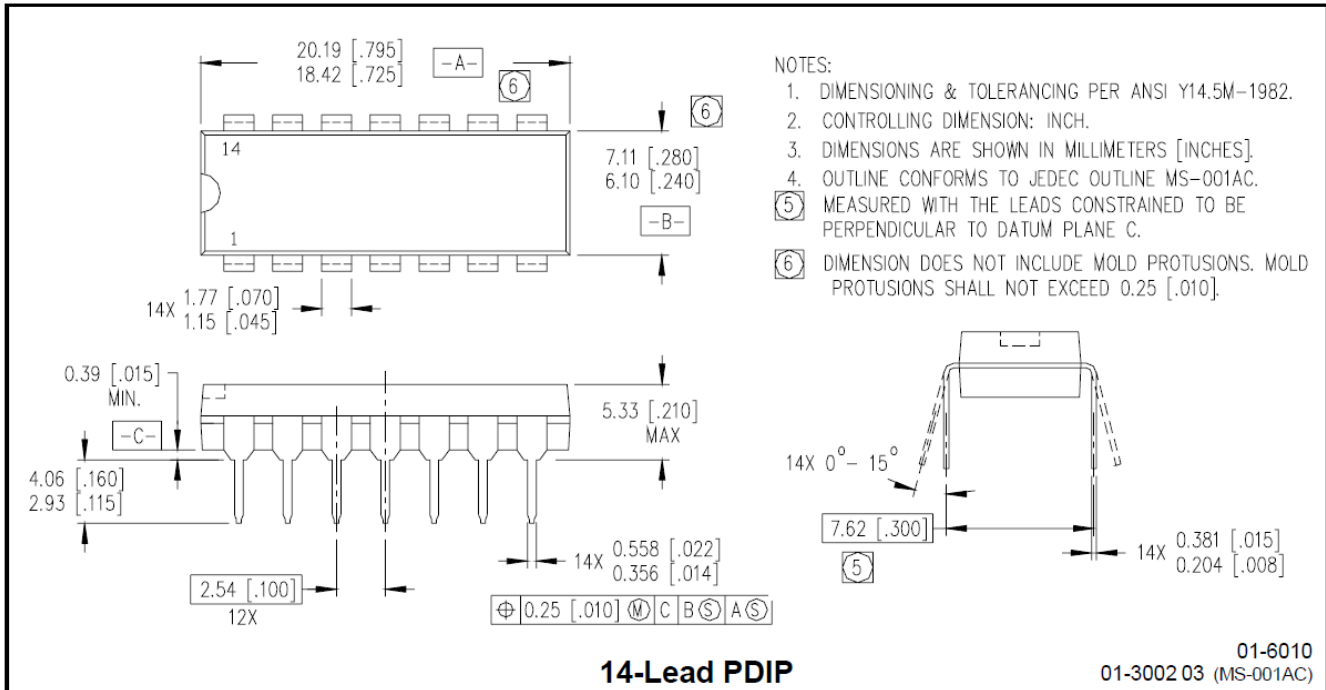
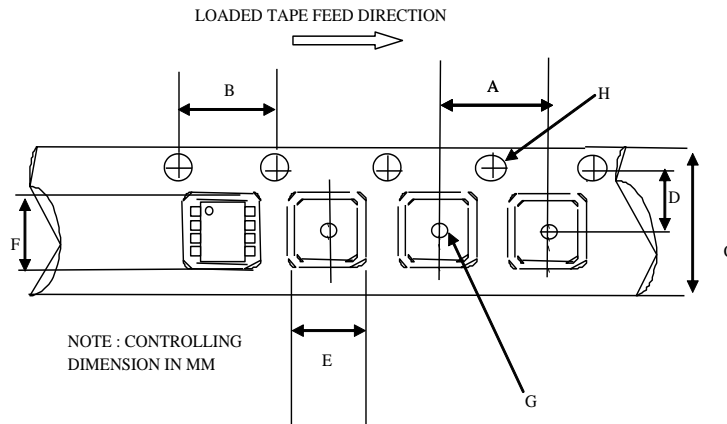

Figure 36. IRS21864S vs. Frequency (IRFPE50)
 $R_{gate} = 10\Omega, V_{CC} = 15V$

Package Details: PDIP8, SO8N

8-Lead PDIP

8-Lead SOIC

Package Details: PDIP14, SO14N

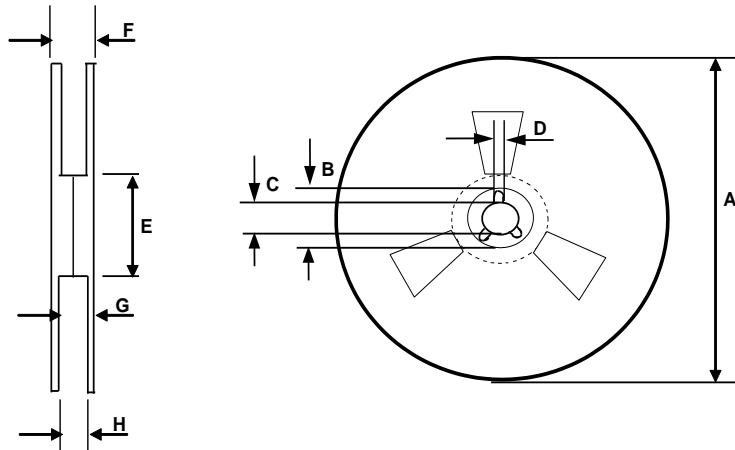
Tape and Reel Details: SO8N

CARRIER TAPE DIMENSION FOR 8SOICN

Code	Metric		Imperial	
	Min	Max	Min	Max
A	7.90	8.10	0.311	0.318
B	3.90	4.10	0.153	0.161
C	11.70	12.30	0.46	0.484
D	5.45	5.55	0.214	0.218
E	6.30	6.50	0.248	0.255
F	5.10	5.30	0.200	0.208
G	1.50	n/a	0.059	n/a
H	1.50	1.60	0.059	0.062

REEL DIMENSIONS FOR 8SOICN

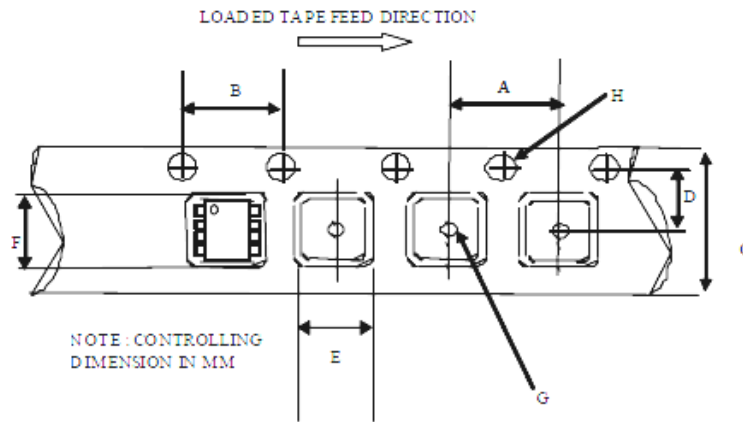
Code	Metric		Imperial	
	Min	Max	Min	Max
A	329.60	330.25	12.976	13.001
B	20.95	21.45	0.824	0.844
C	12.80	13.20	0.503	0.519
D	1.95	2.45	0.767	0.096
E	98.00	102.00	3.858	4.015
F	n/a	18.40	n/a	0.724
G	14.50	17.10	0.570	0.673
H	12.40	14.40	0.488	0.566

Tape and Reel Details: SO14N

CARRIER TAPE DIMENSION FOR 14SO1CN

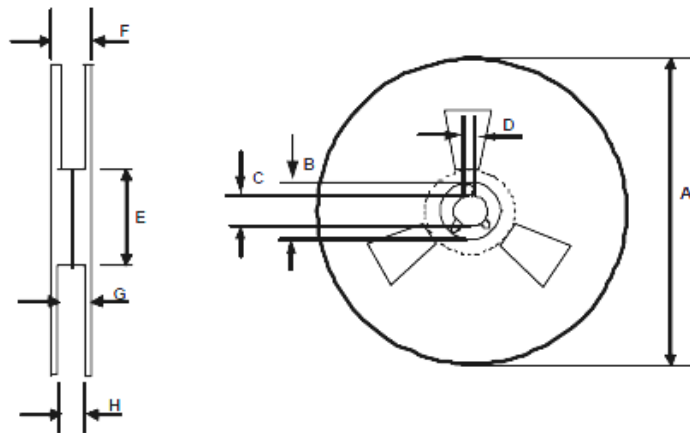
Code	Metric		Imperial	
	Min	Max	Min	Max
A	7.90	8.10	0.311	0.318
B 3	.90	4.10	0.153	0.161
C	15.70	16.30	0.618	0.641
D	7.40	7.60	0.291	0.299
E	6.40	6.60	0.252	0.260
F	9.40	9.60	0.370	0.378
G	1.50	n/a	0.059	n/a
H	1.50	1.60	0.059	0.062

REEL DIMENSIONS FOR 14SO1CN

Code	Metric		Imperial	
	Min	Max	Min	Max
A	329.60	330.25	12.976	13.001
B	20.95	21.45	0.824	0.844
C	12.80	13.20	0.503	0.519
D	1.95	2.45	0.767	0.096
E	98.00	102.00	3.858	4.015
F	n/a	22.40	n/a	0.881
G	18.50	21.10	0.728	0.830
H	16.40	18.40	0.645	0.724

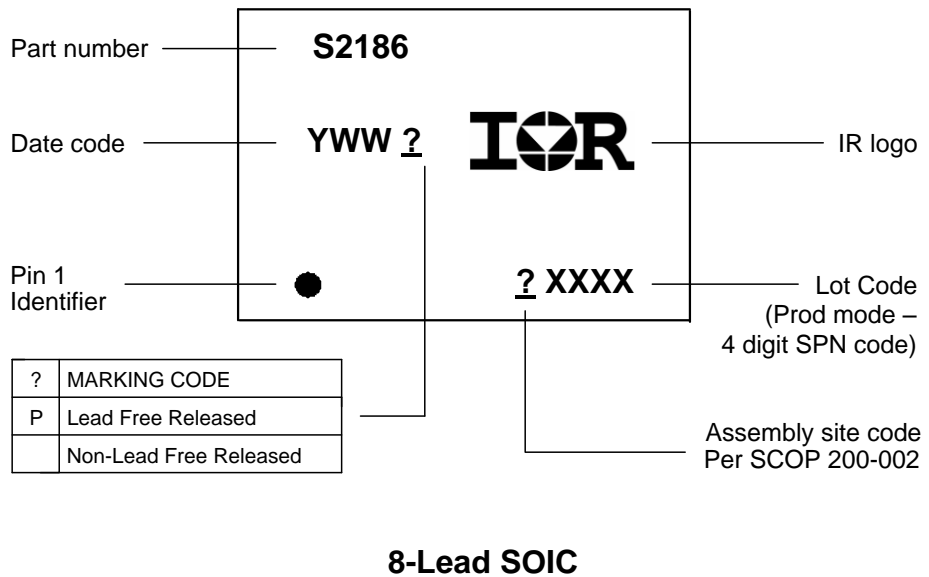
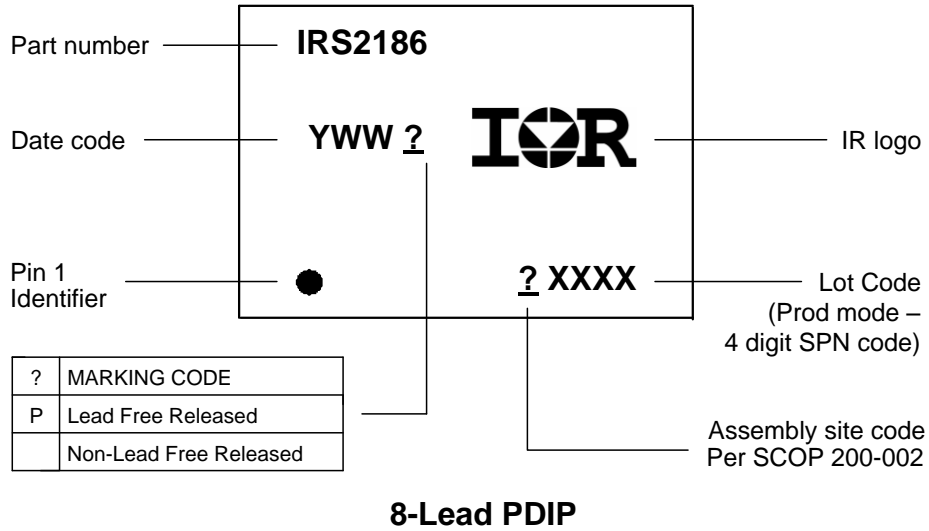
Part Marking Information



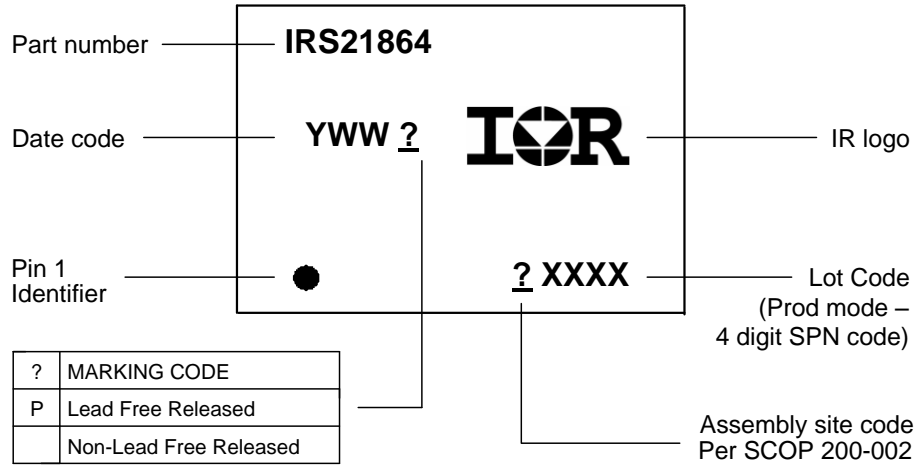

14-Lead PDIP

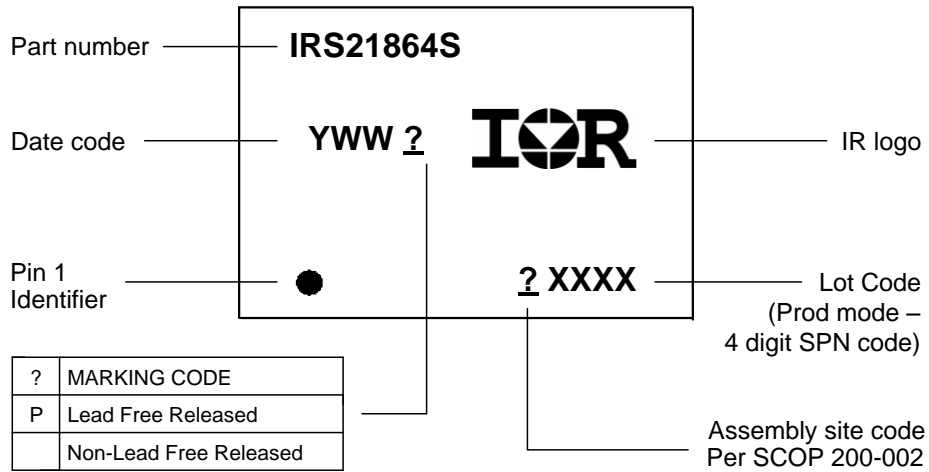

14-Lead SOIC

Qualification Information[†]

Qualification Level	Industrial ^{††} (per JEDEC JESD 47)	
	Comments: This family of ICs has passed JEDEC's Industrial qualification. IR's Consumer qualification level is granted by extension of the higher Industrial level.	
Moisture Sensitivity Level	SOIC8N	MSL2 ^{†††} (per IPC/JEDEC J-STD 020)
	PDIP8	Not applicable (non-surface mount package style)
	SOIC14N	MSL2 ^{†††} (per IPC/JEDEC J-STD 020)
	PDIP14	Not applicable (non-surface mount package style)
RoHS Compliant	Yes	

- † Qualification standards can be found at International Rectifier's web site <http://www.irf.com/>
- †† Higher qualification ratings may be available should the user have such requirements. Please contact your International Rectifier sales representative for further information.
- ††† Higher MSL ratings may be available for the specific package types listed here. Please contact your International Rectifier sales representative for further information.

The information provided in this document is believed to be accurate and reliable. However, International Rectifier assumes no responsibility for the consequences of the use of this information. International Rectifier assumes no responsibility for any infringement of patents or of other rights of third parties which may result from the use of this information. No license is granted by implication or otherwise under any patent or patent rights of International Rectifier. The specifications mentioned in this document are subject to change without notice. This document supersedes and replaces all information previously supplied.

For technical support, please contact IR's Technical Assistance Center
<http://www.irf.com/technical-info/>

WORLD HEADQUARTERS:
 233 Kansas St., El Segundo, California 90245
 Tel: (310) 252-7105

Компания «Life Electronics» занимается поставками электронных компонентов импортного и отечественного производства от производителей и со складов крупных дистрибьюторов Европы, Америки и Азии.

С конца 2013 года компания активно расширяет линейку поставок компонентов по направлению коаксиальный кабель, кварцевые генераторы и конденсаторы (керамические, пленочные, электролитические), за счёт заключения дистрибьюторских договоров

Мы предлагаем:

- Конкурентоспособные цены и скидки постоянным клиентам.
- Специальные условия для постоянных клиентов.
- Подбор аналогов.
- Поставку компонентов в любых объемах, удовлетворяющих вашим потребностям.
- Приемлемые сроки поставки, возможна ускоренная поставка.
- Доставку товара в любую точку России и стран СНГ.
- Комплексную поставку.
- Работу по проектам и поставку образцов.
- Формирование склада под заказчика.
- Сертификаты соответствия на поставляемую продукцию (по желанию клиента).
- Тестирование поставляемой продукции.
- Поставку компонентов, требующих военную и космическую приемку.
- Входной контроль качества.
- Наличие сертификата ISO.

В составе нашей компании организован Конструкторский отдел, призванный помогать разработчикам, и инженерам.

Конструкторский отдел помогает осуществить:

- Регистрацию проекта у производителя компонентов.
- Техническую поддержку проекта.
- Защиту от снятия компонента с производства.
- Оценку стоимости проекта по компонентам.
- Изготовление тестовой платы монтаж и пусконаладочные работы.



Тел: +7 (812) 336 43 04 (многоканальный)

Email: org@lifeelectronics.ru