

## Optocoupler, Phototriac Output, Zero Crossing, High dV/dt, Low Input Current



23042



### FEATURES

- High isolation distance on output
- High static dV/dt 1000 V/ $\mu$ s
- High input sensitivity  $I_{FT} = 5$  mA
- 100 mA on-state current
- Zero voltage crossing detector
- 800 V peak off-state blocking voltage
- Isolation rated voltage 5300 V<sub>RMS</sub>
- Material categorization: for definitions of compliance please see [www.vishay.com/doc?99912](http://www.vishay.com/doc?99912)



### APPLICATIONS

- Power TRIAC driver in solid-state relays
- 3-phase AC equipment
- Motor control
- Industrial control
- White goods / household equipment

### AGENCY APPROVALS

- [UL 1577](#)
- [cUL](#)
- [DIN EN 60747-5-5 \(VDE 0884-5\), available with option "V"](#)
- [CQC](#)

### DESIGN SUPPORT TOOLS

[click logo to get started](#)

### DESCRIPTION

The VOT8025A consists of a GaAs IRLED optically coupled to a photosensitive zero crossing TRIAC packaged in a DIP-6 package featuring a high isolation distance on output.

The VOT8025A isolates low-voltage logic from 120 V<sub>AC</sub>, 240 V<sub>AC</sub>, and 380 V<sub>AC</sub> lines to control resistive, inductive, or capacitive loads including motors, solenoids, high current thyristors or TRIAC and relays.

### ORDERING INFORMATION

|             |   |   |   |   |   |   |   |                |            |               |   |   |
|-------------|---|---|---|---|---|---|---|----------------|------------|---------------|---|---|
| V           | O | T | 8 | 0 | 2 | 5 | A | #              | -          | V             | T | # |
| PART NUMBER |   |   |   |   |   |   |   | PACKAGE OPTION | VDE OPTION | TAPE AND REEL |   |   |

| AGENCY CERTIFIED/PACKAGE | TRIGGER CURRENT, $I_{FT}$ (mA) |
|--------------------------|--------------------------------|
| <b>UL, cUL, CQC</b>      | <b>5</b>                       |
| DIP-6                    | VOT8025AD                      |
| DIP-6, 400 mil           | VOT8025AG                      |
| SMD-6                    | VOT8025AB-T <sup>(1)</sup>     |
| SMD-6, 90° orientation   | VOT8025AB-T1                   |
| SMD-6, 180° orientation  | VOT8025AB-T2                   |
| <b>VDE, UL, cUL, CQC</b> | <b>5</b>                       |
| DIP-6                    | VOT8025AD-V                    |
| DIP-6, 400 mil           | VOT8025AG-V                    |
| SMD-6                    | VOT8025AB-VT <sup>(1)</sup>    |
| SMD-6, 90° orientation   | VOT8025AB-VT1                  |
| SMD-6, 180° orientation  | VOT8025AB-VT2                  |

#### Note

(1) Also available in tubes; do not add T to end



| ABSOLUTE MAXIMUM RATINGS ( $T_{amb} = 25\text{ }^{\circ}\text{C}$ , unless otherwise specified) |                    |              |             |                    |
|---|--------------------|--------------|-------------|--------------------|
| PARAMETER   | TEST CONDITION     | SYMBOL       | VALUE       | UNIT               |
| <b>INPUT</b>  |                    |              |             |                    |
| Reverse voltage   |                    | $V_R$        | 6           | V                  |
| Forward current   |                    | $I_F$        | 50          | mA                 |
| Power dissipation   |                    | $P_{diss}$   | 120         | mW                 |
| <b>OUTPUT</b>   |                    |              |             |                    |
| Peak off-state voltage  |                    | $V_{DRM}$    | 800         | V                  |
| Peak repetitive surge current   | PW = 1 ms, 120 pps | $I_{TSM}$    | 1           | A                  |
| On-state current  |                    | $I_{T(RMS)}$ | 100         | mA                 |
| Power dissipation   |                    | $P_{diss}$   | 150         | mW                 |
| <b>COUPLER</b>  |                    |              |             |                    |
| Storage temperature range   |                    | $T_{stg}$    | -55 to +150 | $^{\circ}\text{C}$ |
| Ambient temperature range   |                    | $T_{amb}$    | -40 to +110 | $^{\circ}\text{C}$ |
| Total power dissipation   |                    | $P_{diss}$   | 250         | mW                 |
| Soldering temperature   | For 10 s           | $T_{sld}$    | 260         | $^{\circ}\text{C}$ |

**Note**

- Stresses in excess of the absolute maximum ratings can cause permanent damage to the device. Functional operation of the device is not implied at these or any other conditions in excess of those given in the operational sections of this document. Exposure to absolute maximum ratings for extended periods of the time can adversely affect reliability. This phototriac should not be used to drive a load directly. It is intended to be a trigger device only



Fig. 1 - Maximum Forward Current vs. Ambient Temperature



Fig. 2 - Maximum On-State Current vs. Ambient Temperature



| <b>ELECTRICAL CHARACTERISTICS</b> ( $T_{amb} = 25\text{ }^{\circ}\text{C}$ , unless otherwise specified) |   |               |      |      |      |                        |
|--|---|---------------|------|------|------|------------------------|
| PARAMETER  | TEST CONDITION  | SYMBOL        | MIN. | TYP. | MAX. | UNIT                   |
| <b>INPUT</b>   |   |               |      |      |      |                        |
| Forward voltage  | $I_F = 20\text{ mA}$  | $V_F$         | -    | 1.2  | 1.4  | V                      |
| Reverse current  | $V_R = 6\text{ V}$  | $I_R$         | -    | 0.05 | 10   | $\mu\text{A}$          |
| <b>OUTPUT</b>  |   |               |      |      |      |                        |
| Off-state current  | $V_{DRM} = 800\text{ V}$  | $I_{DRM}$     | -    | -    | 0.5  | $\mu\text{A}$          |
| On-state voltage   | $I_T = 100\text{ mA peak}$  | $V_{TM}$      | -    | -    | 3    | V                      |
| Holding current  |   | $I_H$         | -    | 400  | -    | $\mu\text{A}$          |
| Zero cross inhibit voltage   | $I_F = \text{rated } I_{FT}$  | $V_{INH}$     | -    | 5    | 20   | V                      |
| Critical rate of rise of off-state voltage   |   | $dV/dt^{(1)}$ | 1000 | -    | -    | $\text{V}/\mu\text{s}$ |
| Leakage in inhibit state   | $I_F = \text{rated } I_{FT}, \text{ rated } V_{DRM}, \text{ off-state}$ | $I_{DRM2}$    | -    | -    | 500  | $\mu\text{A}$          |
| <b>COUPLER</b>   |   |               |      |      |      |                        |
| Trigger current  | $V_{TM} = 3\text{ V}$   | $I_{FT}$      | -    | -    | 5    | mA                     |

**Notes**

- Minimum and maximum values were tested requirements. Typical values are characteristics of the device and are the result of engineering evaluations. Typical values are for information only and are not part of the testing requirements
- <sup>(1)</sup> Static  $dV/dt$

| <b>SAFETY AND INSULATION RATINGS</b> ( $T_{amb} = 25\text{ }^{\circ}\text{C}$ , unless otherwise specified) |  |            |                |                    |
|---|--|------------|----------------|--------------------|
| PARAMETER   | TEST CONDITION   | SYMBOL     | VALUE          | UNIT               |
| Climatic classification   | According to IEC 68 part 1                                     |            | 55 / 115 / 21  |                    |
| Comparative tracking index  | Insulation group IIIa  | CTI        | 175            |                    |
| Maximum rated withstanding isolation voltage  | According to UL1577, $t = 1\text{ min}$                        | $V_{ISO}$  | 5300           | $V_{RMS}$          |
| Maximum transient isolation voltage   | According to DIN EN 60747-5-5                                  | $V_{IOTM}$ | 8000           | $V_{peak}$         |
| Maximum repetitive peak isolation voltage   | According to DIN EN 60747-5-5, DIP-4, SMD-4                    | $V_{IORM}$ | 890            | $V_{peak}$         |
|   | According to DIN EN 60747-5-5, DIP-4, 400 mil                  | $V_{IORM}$ | 1140           | $V_{peak}$         |
| Isolation resistance  | $V_{IO} = 500\text{ V}, T_{amb} = 25\text{ }^{\circ}\text{C}$  | $R_{IO}$   | $\geq 10^{12}$ | $\Omega$           |
|   | $V_{IO} = 500\text{ V}, T_{amb} = 100\text{ }^{\circ}\text{C}$ | $R_{IO}$   | $\geq 10^{11}$ | $\Omega$           |
| Output safety power   |  | $P_{SO}$   | 700            | mW                 |
| Input safety current  |  | $I_{SI}$   | 400            | mA                 |
| Input safety temperature  |  | $T_S$      | 175            | $^{\circ}\text{C}$ |
| Creepage distance   | DIP-6, SMD-6   |            | $\geq 7$       | mm                 |
| Clearance distance  |  |            | $\geq 7$       | mm                 |
| Creepage distance   | DIP-6, 400 mil   |            | $\geq 8$       | mm                 |
| Clearance distance  |  |            | $\geq 8$       | mm                 |
| Insulation thickness  |  | DTI        | $\geq 0.4$     | mm                 |

**Note**

- As per IEC 60747-5-5, § 7.4.3.8.2, this optocoupler is suitable for “safe electrical insulation” only within the safety ratings. Compliance with the safety ratings shall be ensured by means of protective circuits



## TYPICAL CHARACTERISTICS ( $T_{amb} = 25\text{ }^{\circ}\text{C}$ , unless otherwise specified)



Fig. 3 - Forward Current vs. Forward Voltage



Fig. 6 - On State Current vs. On State Voltage



Fig. 4 - Normalized Trigger Current vs. Ambient Temperature



Fig. 7 - Normalized Holding Current vs. Ambient Temperature



Fig. 5 - Trigger Current vs. Pulse Width



Fig. 8 - Off-State Leakage Current vs. Ambient Temperature

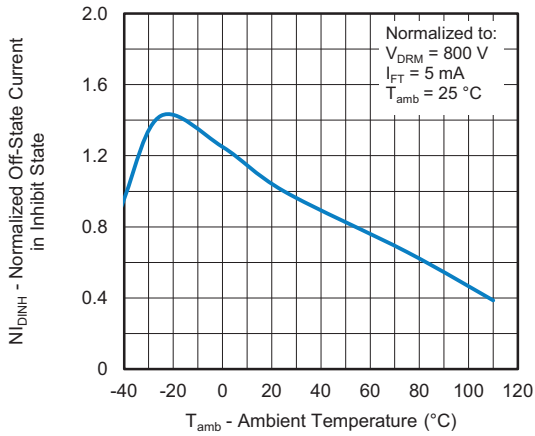

Fig. 9 - Normalized Off-State Current in Inhibit State vs. Ambient Temperature

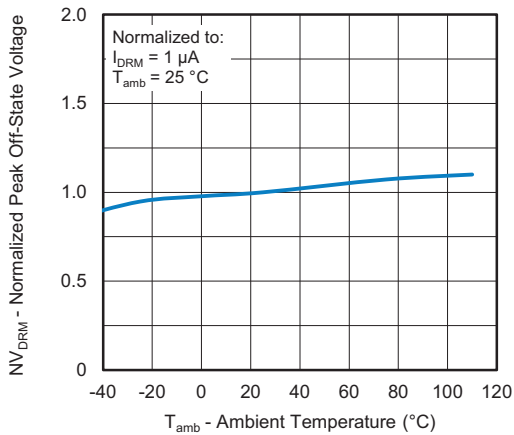

Fig. 10 - Normalized Peak Off-State Voltage vs. Ambient Temperature

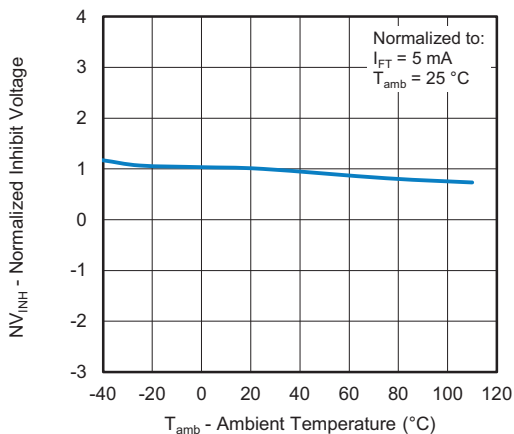

Fig. 11 - Normalized Inhibit Voltage vs. Ambient Temperature



## PACKAGE DIMENSIONS (in millimeters)

### DIP-6

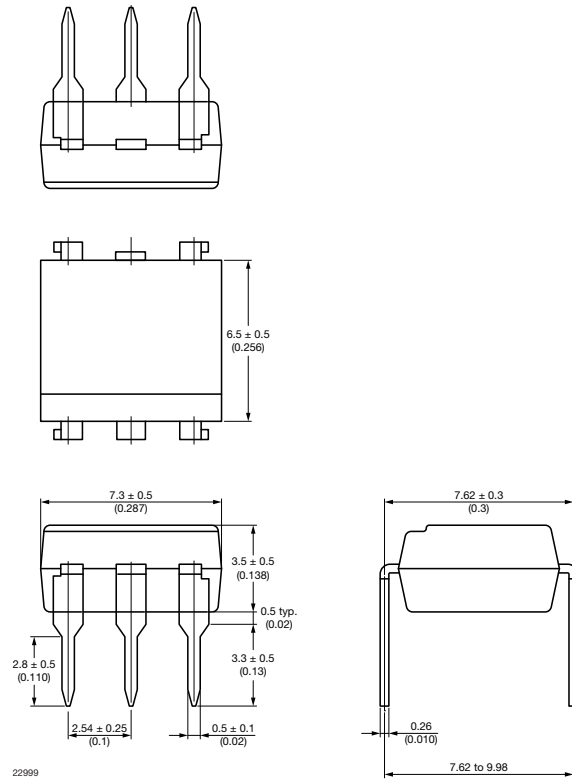

Fig. 12

### DIP-6, 400 mil



Fig. 13

**SMD-6**



Fig. 14

**PACKAGE MARKING**



Fig. 15 - Example of VOT8025AD-VT

**Notes**

- "YWW" is the date code marking (Y = year code, WW = week code)
- VDE logo is only marked on VDE option parts
- Tape and reel suffix (T) is not part of the package marking



## PACKAGING INFORMATION (in millimeters)

| DEVICES PER TUBE |            |           |           |
|------------------|------------|-----------|-----------|
| TYPE             | UNITS/TUBE | TUBES/BOX | UNITS/BOX |
| DIP-6            | 50         | 40        | 2000      |
| DIP-6, 400 mil   | 50         | 40        | 2000      |

### SMD-6 Tape

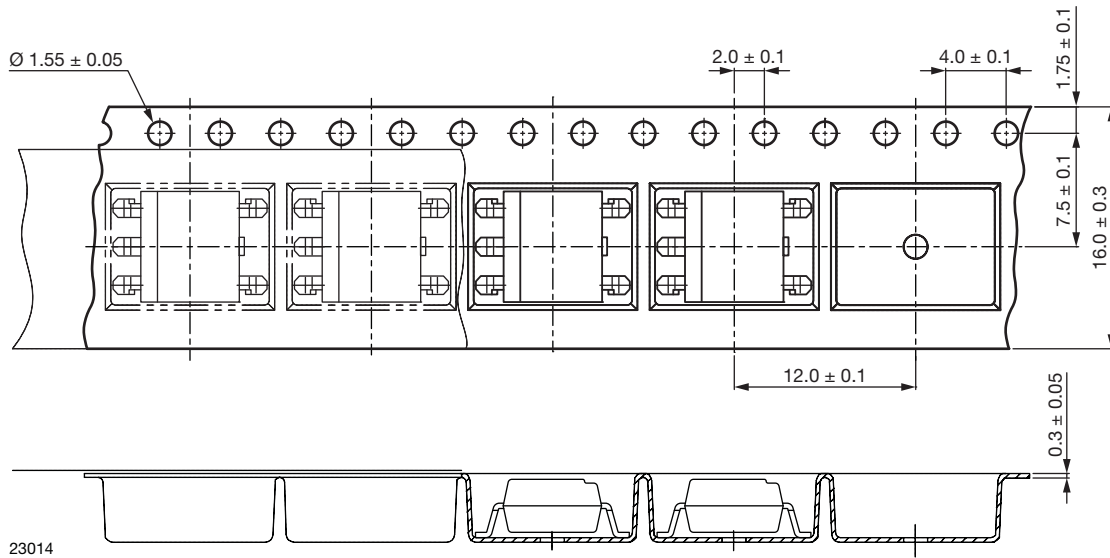

Fig. 16 - Tape and Reel Packaging (1000 pieces on reel)

### SMD-6 Tape, 180° Orientation

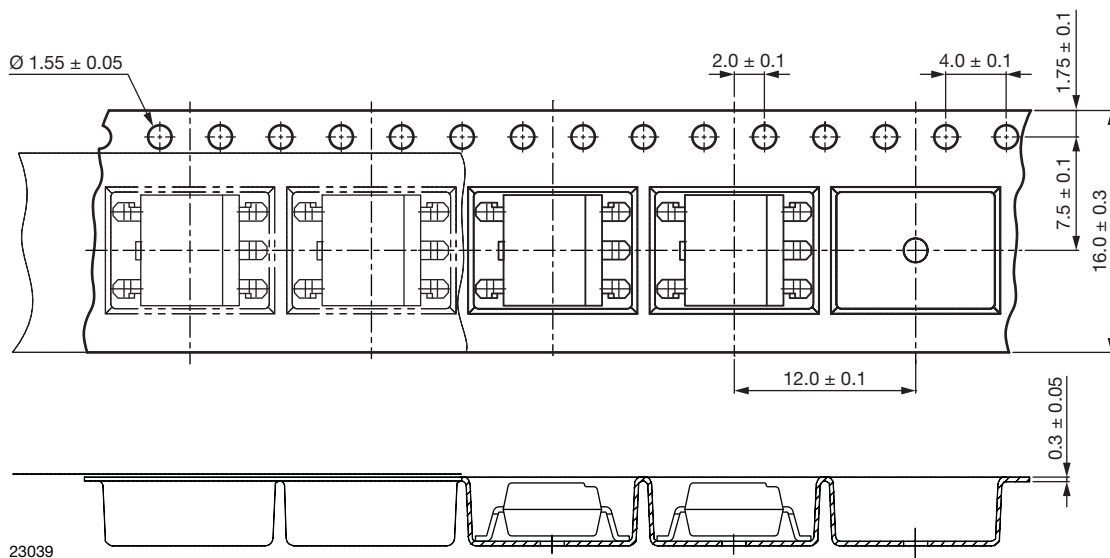

Fig. 17 - Tape and Reel Packaging (1000 pieces on reel)





Reel



Fig. 18 - Tape and Reel Shipping Medium

**SOLDER PROFILES**
**IR Reflow Soldering (JEDEC® J-STD-020C compliant)**

One time soldering reflow is recommended within the condition of temperature and time profile shown below. Do not solder more than three times.

| PROFILE ITEM                                   | CONDITIONS       |
|--|------------------|
| Preheat  |                  |
| - Temperature minimum ( $T_{S \text{ min.}}$ ) | 150 °C           |
| - Temperature maximum ( $T_{S \text{ max.}}$ ) | 200 °C           |
| - Time (min. to max.) ( $t_s$ )                | 90 s $\pm$ 30 s  |
| Soldering zone                                 |                  |
| - Temperature ( $T_L$ )                        | 217 °C           |
| - Time ( $t_L$ )                               | 60 s             |
| Peak temperature ( $T_p$ )                     | 260 °C           |
| Ramp-up rate                                   | 3 °C/s max.      |
| Ramp-down rate                                 | 3 °C/s to 6 °C/s |



23017

Fig. 20

**Hand Soldering by Soldering Iron**

Allow single lead soldering in every single process. One time soldering is recommended.

Temperature: 380 °C + 0 °C / - 5 °C

Time: 3 s max.

**HANDLING AND STORAGE CONDITIONS**

ESD level: HBM class 2

Floor life: unlimited

Conditions:  $T_{\text{amb}} < 30 \text{ °C}$ , RH < 85 %

Moisture sensitivity level 1, according to J-STD-020

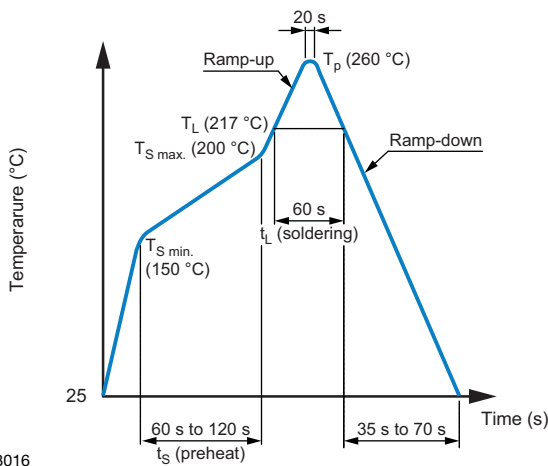

23016

Fig. 19

**Wave Soldering (JEDEC JESD22-A111 compliant)**

One time soldering is recommended within the condition of temperature.

Temperature: 260 °C + 0 °C / - 5 °C

Time: 10 s

Preheat temperature: 25 °C to 140 °C

Preheat time: 30 s to 80 s



## **Disclaimer**

ALL PRODUCT, PRODUCT SPECIFICATIONS AND DATA ARE SUBJECT TO CHANGE WITHOUT NOTICE TO IMPROVE RELIABILITY, FUNCTION OR DESIGN OR OTHERWISE.

Vishay Intertechnology, Inc., its affiliates, agents, and employees, and all persons acting on its or their behalf (collectively, "Vishay"), disclaim any and all liability for any errors, inaccuracies or incompleteness contained in any datasheet or in any other disclosure relating to any product.

Vishay makes no warranty, representation or guarantee regarding the suitability of the products for any particular purpose or the continuing production of any product. To the maximum extent permitted by applicable law, Vishay disclaims (i) any and all liability arising out of the application or use of any product, (ii) any and all liability, including without limitation special, consequential or incidental damages, and (iii) any and all implied warranties, including warranties of fitness for particular purpose, non-infringement and merchantability.

Statements regarding the suitability of products for certain types of applications are based on Vishay's knowledge of typical requirements that are often placed on Vishay products in generic applications. Such statements are not binding statements about the suitability of products for a particular application. It is the customer's responsibility to validate that a particular product with the properties described in the product specification is suitable for use in a particular application. Parameters provided in datasheets and / or specifications may vary in different applications and performance may vary over time. All operating parameters, including typical parameters, must be validated for each customer application by the customer's technical experts. Product specifications do not expand or otherwise modify Vishay's terms and conditions of purchase, including but not limited to the warranty expressed therein.

Except as expressly indicated in writing, Vishay products are not designed for use in medical, life-saving, or life-sustaining applications or for any other application in which the failure of the Vishay product could result in personal injury or death. Customers using or selling Vishay products not expressly indicated for use in such applications do so at their own risk. Please contact authorized Vishay personnel to obtain written terms and conditions regarding products designed for such applications.

No license, express or implied, by estoppel or otherwise, to any intellectual property rights is granted by this document or by any conduct of Vishay. Product names and markings noted herein may be trademarks of their respective owners.

Компания «Life Electronics» занимается поставками электронных компонентов импортного и отечественного производства от производителей и со складов крупных дистрибьюторов Европы, Америки и Азии.

С конца 2013 года компания активно расширяет линейку поставок компонентов по направлению коаксиальный кабель, кварцевые генераторы и конденсаторы (керамические, пленочные, электролитические), за счёт заключения дистрибьюторских договоров

Мы предлагаем:

- Конкуренеспособные цены и скидки постоянным клиентам.
- Специальные условия для постоянных клиентов.
- Подбор аналогов.
- Поставку компонентов в любых объемах, удовлетворяющих вашим потребностям.
- Приемлемые сроки поставки, возможна ускоренная поставка.
- Доставку товара в любую точку России и стран СНГ.
- Комплексную поставку.
- Работу по проектам и поставку образцов.
- Формирование склада под заказчика.
- Сертификаты соответствия на поставляемую продукцию (по желанию клиента).
- Тестирование поставляемой продукции.
- Поставку компонентов, требующих военную и космическую приемку.
- Входной контроль качества.
- Наличие сертификата ISO.

В составе нашей компании организован Конструкторский отдел, призванный помогать разработчикам, и инженерам.

Конструкторский отдел помогает осуществить:

- Регистрацию проекта у производителя компонентов.
- Техническую поддержку проекта.
- Защиту от снятия компонента с производства.
- Оценку стоимости проекта по компонентам.
- Изготовление тестовой платы монтаж и пусконаладочные работы.



Тел: +7 (812) 336 43 04 (многоканальный)

Email: [org@lifeelectronics.ru](mailto:org@lifeelectronics.ru)