

Features

- RoHS compliant*
- Low power loss and high efficiency
- High current capability
- Low profile package

Applications

- AC operated products
- Computer monitors
- Set-top boxes
- Cable modems

CD-MBL1xxS Surface Mount Bridge Rectifier Diode

General Information

The markets of portable communications, computing and video equipment are challenging the semiconductor industry to develop increasingly smaller electronic components.

Bourns offers Bridge Rectifier Diodes for rectification applications in compact chip package 0.23" x 0.20" size format, which offers PCB real estate savings and are considerably smaller than standard parts. The Bridge Rectifier Diodes offer a forward current of 1 A with a choice of repetitive peak reverse voltages between 200 V and 1000 V.

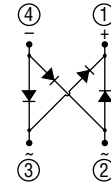

Absolute Maximum Ratings (@ T_A = 25 °C Unless Otherwise Noted)

Parameter	Symbol	CD-					Unit
		MBL102S	MBL104S	MBL106S	MBL108S	MBL110S	
Maximum Repetitive Peak Reverse Voltage	V _{RRM}	200	400	600	800	1000	V
Maximum RMS Voltage	V _{RMS}	140	280	420	560	700	V
Maximum Average Forward Rectified Current (T _A = 55 °C)	I _{F(AV)}	1					A
Peak Forward Surge Current 8.3 ms Single Half Sine-Wave Superimposed on Rated Load (JEDEC Method)	I _{FSM}	30					A
Operating Temperature Range	T _J	-55 to +175					°C
Storage Temperature Range	T _{STG}	-55 to +175					°C

Electrical Characteristics (@ T_A = 25 °C Unless Otherwise Noted)

Parameter	Symbol	CD-MBL1xxS			Unit	
		Test Conditions	Min.	Typ.		Max.
Instantaneous Forward Voltage	V _F	I _F = 1 A		0.95	1.0	V
Repetitive Peak Reverse Current	I _{RRM}	V _R = V _{RRM}	T _A = +25 °C		5.0	μA
			T _A = +150 °C			200
Junction Capacitance	C _J	V _R = 4 V, f = 1.0 MHz		25		pF
Thermal Resistance, Junction to Air ⁽¹⁾	R _{θJA}			95		°C / W
Thermal Resistance, Junction to Lead ⁽¹⁾	R _{θJL}			20		°C / W

NOTE 1: Measured when mounted on PCB with 5.0 mm x 5.0 mm (0.2" x 0.2") copper pad areas.

*RoHS Directive 2002/95/EC Jan. 27, 2003 including annex and RoHS Recast 2011/65/EU June 8, 2011.

Specifications are subject to change without notice.

The device characteristics and parameters in this data sheet can and do vary in different applications and actual device performance may vary over time. Users should verify actual device performance in their specific applications.

CD-MBL1xxS Surface Mount Bridge Rectifier Diode



Rating and Characteristic Curves

Forward Current Derating Curve

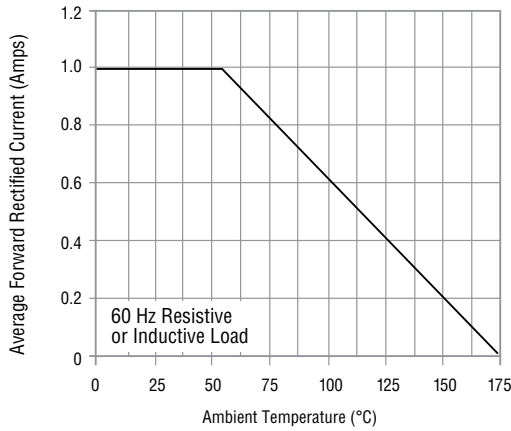

Maximum Non-Repetitive Peak Forward Surge Current

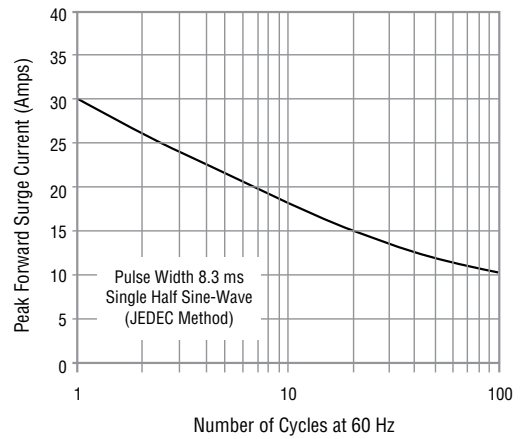

Forward Characteristics

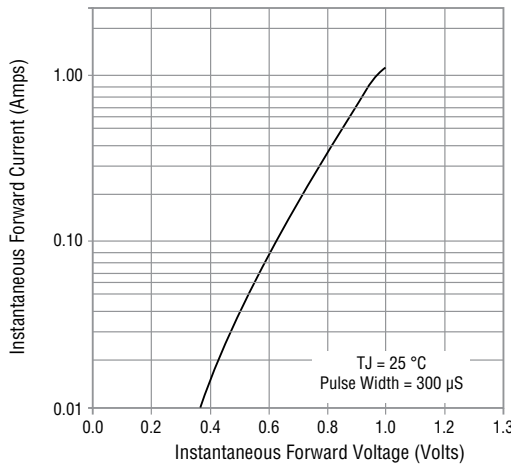

Reverse Characteristics

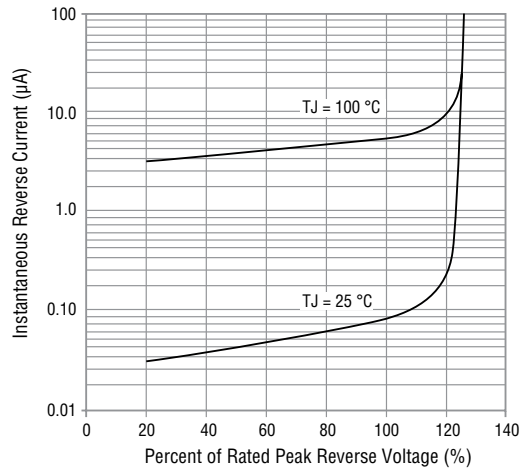

Typical Junction Capacitance

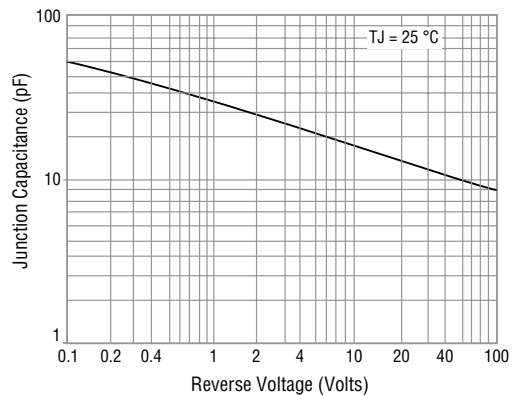

Specifications are subject to change without notice. The device characteristics and parameters in this data sheet can and do vary in different applications and actual device performance may vary over time. Users should verify actual device performance in their specific applications.

CD-MBL1xxS Surface Mount Bridge Rectifier Diode



Product Dimensions

This is an RoHS2 compliant product, packaged with FRP substrate and is epoxy underfilled. The terminals are pure tin plated (lead free) and are solderable per MIL-STD-750, Method 2026. The package and dimensions are shown below.

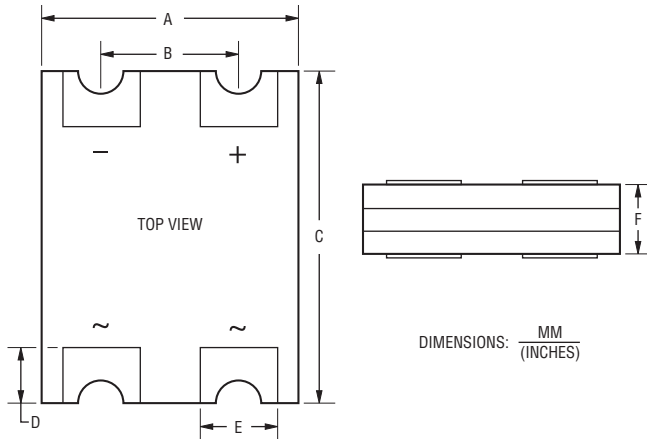

Dimensions	
A	$\frac{5.20 - 5.40}{(0.205 - 0.213)}$
B	$\frac{4.10 - 4.30}{(0.161 - 0.169)}$
C	$\frac{5.70 - 5.90}{(0.224 - 0.232)}$
D	$\frac{1.00 - 1.20}{(0.039 - 0.047)}$
E	$\frac{0.85 - 0.95}{(0.033 - 0.037)}$
F	$\frac{0.86 - 1.16}{(0.0338 - 0.0457)}$

Recommended Footprint

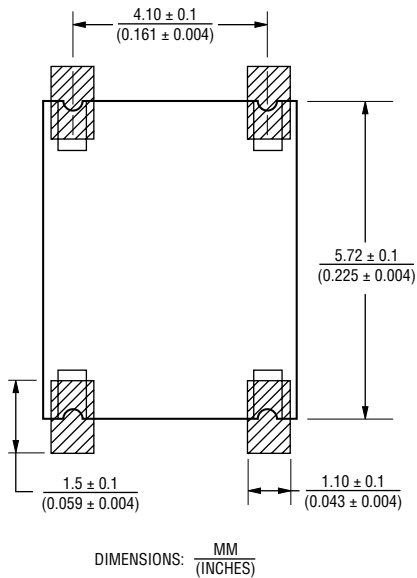

How to Order

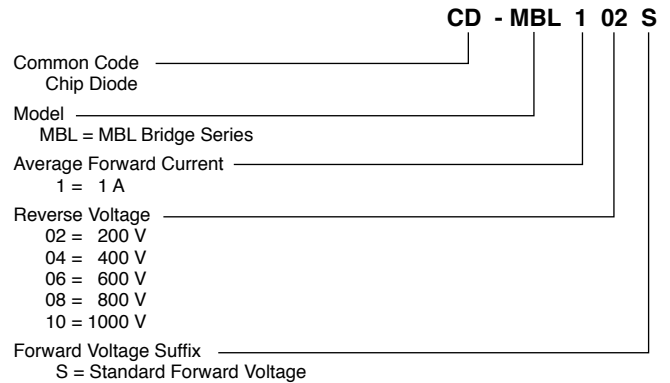

Typical Part Marking

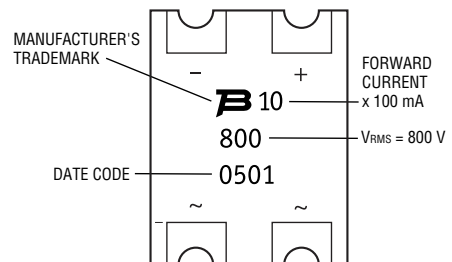

Specifications are subject to change without notice.
 The device characteristics and parameters in this data sheet can and do vary in different applications and actual device performance may vary over time.
 Users should verify actual device performance in their specific applications.

CD-MBL1xxS Surface Mount Bridge Rectifier Diode

BOURNS®

Packaging Information

The surface mount product is packaged in a 12 mm x 8 mm tape and reel format per EIA-481 standard.

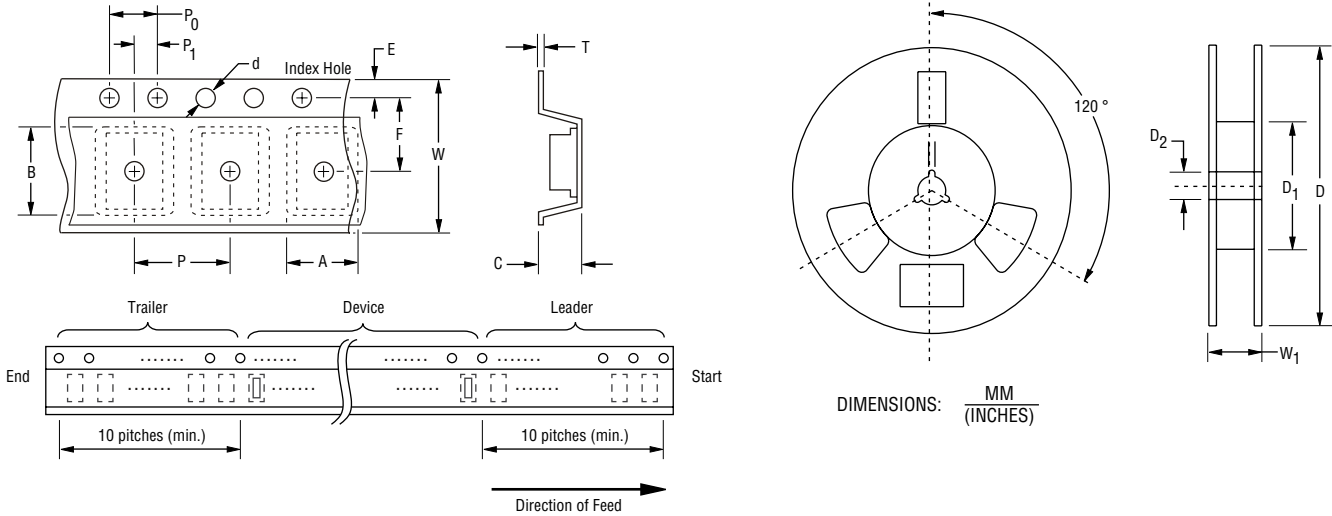

Item	Symbol	CD-MBL1xxS
Carrier Width	A	$\frac{5.90 \pm 0.10}{(0.232 \pm 0.004)}$
Carrier Length	B	$\frac{6.50 \pm 0.10}{(0.256 \pm 0.004)}$
Carrier Depth	C	$\frac{1.50 \pm 0.10}{(0.059 \pm 0.004)}$
Sprocket Hole	d	$\frac{1.55 \pm 0.05}{(0.061 \pm 0.002)}$
Reel Outside Diameter	D	$\frac{330}{(12.992)}$
Reel Inner Diameter	D ₁	$\frac{50.0}{(1.969)}$ MIN.
Feed Hole Diameter	D ₂	$\frac{13.0 \pm 0.20}{(0.512 \pm 0.008)}$
Sprocket Hole Position	E	$\frac{1.75 \pm 0.10}{(0.069 \pm 0.004)}$
Punch Hole Position	F	$\frac{5.50 \pm 0.05}{(0.217 \pm 0.002)}$
Punch Hole Pitch	P	$\frac{8.00 \pm 0.10}{(0.315 \pm 0.004)}$
Sprocket Hole Pitch	P ₀	$\frac{4.00 \pm 0.10}{(0.157 \pm 0.004)}$
Embossment Center	P ₁	$\frac{2.00 \pm 0.05}{(0.079 \pm 0.002)}$
Overall Tape Thickness	T	$\frac{0.20 \pm 0.10}{(0.008 \pm 0.004)}$
Tape Width	W	$\frac{12.00 \pm 0.20}{(0.472 \pm 0.008)}$
Reel Width	W ₁	$\frac{18.7}{(0.736)}$ MAX.
Quantity per Reel	--	5,000

BOURNS®

Asia-Pacific:

Tel: +886-2 2562-4117

Email: asiacus@bourns.com

Europe:

Tel: +36 88 520 390

Email: eurocus@bourns.com

The Americas:

Tel: +1-951 781-5500

Email: americus@bourns.com

www.bourns.com

REV. 02/17

Specifications are subject to change without notice. The device characteristics and parameters in this data sheet can and do vary in different applications and actual device performance may vary over time. Users should verify actual device performance in their specific applications.

Компания «Life Electronics» занимается поставками электронных компонентов импортного и отечественного производства от производителей и со складов крупных дистрибьюторов Европы, Америки и Азии.

С конца 2013 года компания активно расширяет линейку поставок компонентов по направлению коаксиальный кабель, кварцевые генераторы и конденсаторы (керамические, пленочные, электролитические), за счёт заключения дистрибьюторских договоров

Мы предлагаем:

- Конкуренспособные цены и скидки постоянным клиентам.
- Специальные условия для постоянных клиентов.
- Подбор аналогов.
- Поставку компонентов в любых объемах, удовлетворяющих вашим потребностям.
- Приемлемые сроки поставки, возможна ускоренная поставка.
- Доставку товара в любую точку России и стран СНГ.
- Комплексную поставку.
- Работу по проектам и поставку образцов.
- Формирование склада под заказчика.
- Сертификаты соответствия на поставляемую продукцию (по желанию клиента).
- Тестирование поставляемой продукции.
- Поставку компонентов, требующих военную и космическую приемку.
- Входной контроль качества.
- Наличие сертификата ISO.

В составе нашей компании организован Конструкторский отдел, призванный помогать разработчикам, и инженерам.

Конструкторский отдел помогает осуществить:

- Регистрацию проекта у производителя компонентов.
- Техническую поддержку проекта.
- Защиту от снятия компонента с производства.
- Оценку стоимости проекта по компонентам.
- Изготовление тестовой платы монтаж и пусконаладочные работы.



Тел: +7 (812) 336 43 04 (многоканальный)
Email: org@lifeelectronics.ru