

Flat Cable Connectors XG4

Industry Standard Circuit Board Connectors Conform to MIL Standards

- XG4M-U: Unique locking system, with lock levers on strain relief / socket instead of on plug, saves 24% of space
- Space-saving Box-type Plugs (XG4C) available.
- Can be used with XG5 IDC Connectors for discrete wires, XG8 Original PCB Plugs, and the XG2 IDC Bus Connectors for PCBs.
- The Original Plugs (XG8) and the Box-type Plugs (XG4C) can be locked using External XG5Z and XG4Z Lock Levers.
- Conforms to MIL standards (MIL-C-83503).
- UL recognition (file No. E103202)

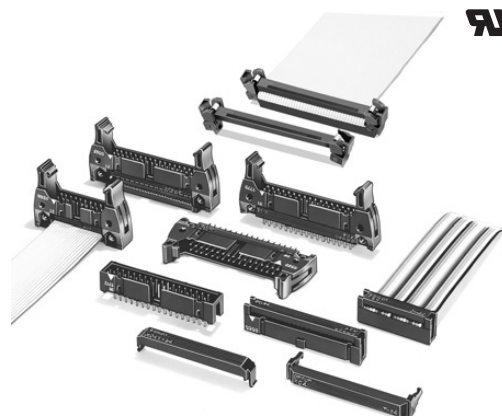

Ordering Information

Connector	Cable			PCB			
	Socket XG4M		Plug XG4E	XG4A	Plug XG4A	XG4C	Socket XG4H
Strain relief	XG4U	XG4T	XG4S	---	---	---	---
Feature	Strain relief with lock levers	Strain relief without lock levers	Lock levers on connector	Integral lock levers	2-tier with lock levers	Box type plug	Board to Board Socket
Appearance							

- Note: 1.** XG4M can be provided with or without the strain reliefs;
 ⇒ XG4M-U consists of XG4M-□□3□ socket + XG4U-□□04 strain relief
 ⇒ XG4M-T consists of XG4M-□□3□ socket + XG4T-□□04 strain relief
- 2.** XG4H PCB mount socket mates with XG4C and XG8W (see XG8 Datasheet) for board to board connectivity without cables.
- 3.** XG5 connectors (see XG5 Datasheet) use discrete wire instead of flat ribbon cable.
- 4.** XG4A PCB mount sockets are available with Long, Short or no Lock Levers.
- 5.** Optional XG4Z-001□ side-lock levers, purchased separately, are available for use with right-angle XG4A versions that don't include them.
- 6.** Optional XG4Z-0002 and XG5Z-0002 top-lock levers are available for mating XG4M(-T) sockets to XG4C and XG8 plugs.

■ Ratings and Characteristics

Item	MIL Sockets: XG4M Cable Plug: XG4E	MIL Plugs: XG4A Box-type PCB Plugs: XG4C Board to Board Sockets: XG4H
Rated current	1 A	3 A (See note 1.)
Rated voltage	250 VAC	300 VAC
Contact resistance	20 mΩ max. (at 20 mV, 100 mA max.)	
Insulation resistance	1,000 MΩ min. (at 500 VDC)	
Dielectric strength	500 VAC for 1 min (leakage current: 1 mA max.)	
Connector insertion	1.96 N max. per contact	
Contact removal	0.39 N min. (with test gauge, t= 0.64 mm)	
Insertion durability	50 times (See note 2.)	
Ambient temperature	Operating: -55 to 105°C (with no icing)	

- Note: 1.** The rated current will depend on the Socket you are using. It is 1 A using the XG4M for example.
- 2.** For standard 0.15-μm gold plating.

Materials and Finish

Item		MIL Plugs: XG4A Box-type Plugs: XG4C	Cable Plugs: XG4E (Strain Relief: XG4S)	MIL Sockets: XG4M (Strain Relief: XG4T)	Board-to-board Connector: XG4H
Housings		Fiber-glass reinforced PBT resin (UL94V-0)/black			
Covers		—	Polyamide resin (UL94V-0)/ black	Fiber-glass reinforced PBT resin (UL94V-0)/black	—
Contacts	Mating end	Brass/nickel base, 0.15- μ m gold plating (See note.)	Phosphor bronze/nickel base, 0.15- μ m gold plating (See note.)		
	Terminal Press fit	Brass/nickel base, tin plating	Phosphor bronze/nickel base, tin plating		
Strain Reliefs		—	Polyamide resin (UL94V-0)/ black	Fiber-glass reinforced PBT resin (UL94V-0)/black	—

Note: For non-standard plating, contact your OMRON representative.

Applicable Wires

1.27-mm pitch, 7-strand flat cable

• UL2651 (standard cable)

• UL20012 (folding cable)

• UL20028 (color-coded cable)

Mating Combinations for XG4, XG5 and XG8

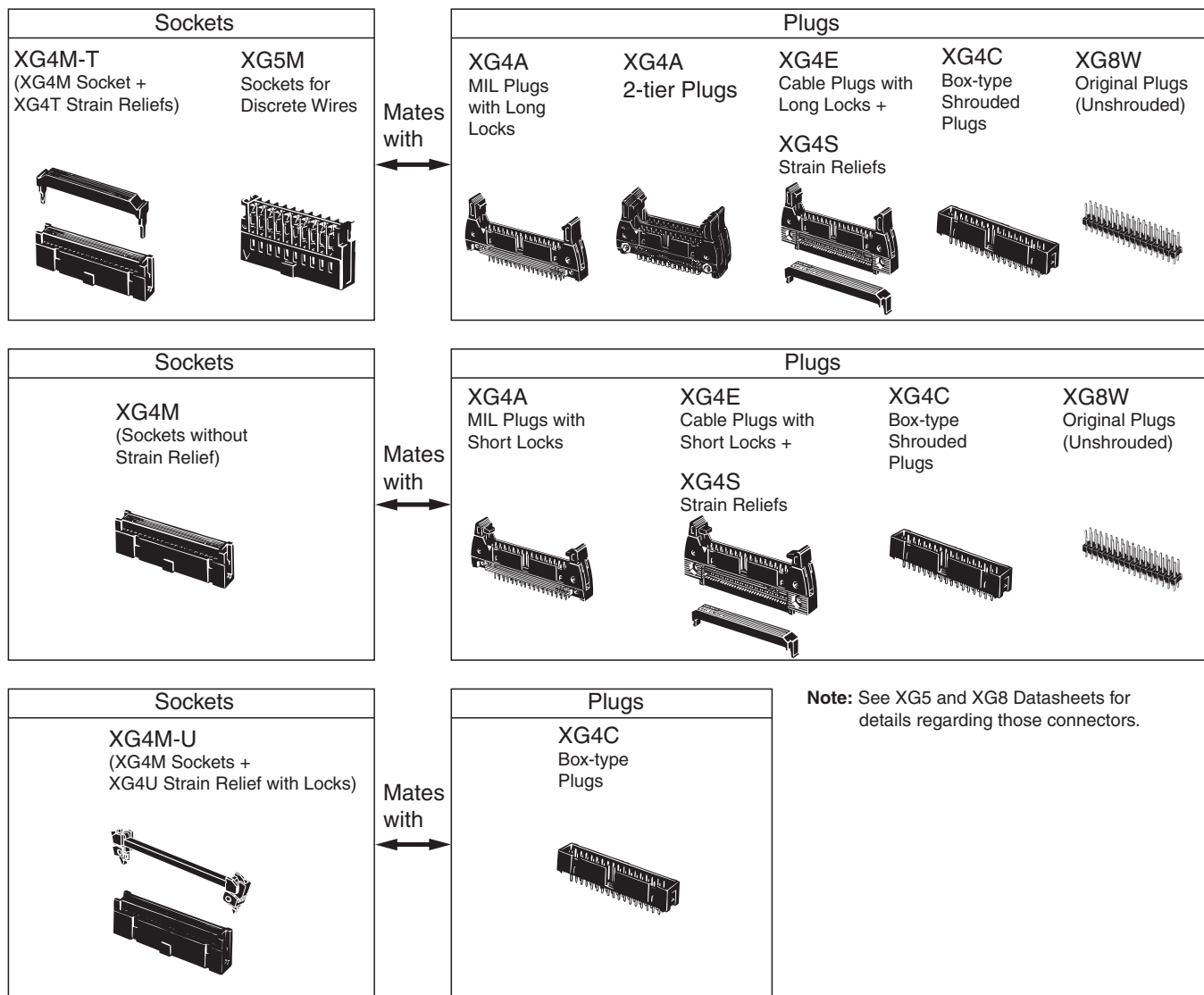

Mating Diagrams for XG4M

XG4U + XG4M + XG4C
(With straight terminals)

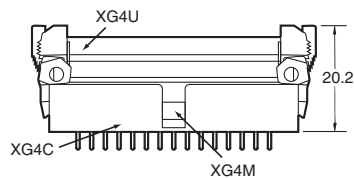

XG4T + XG4M + XG4A

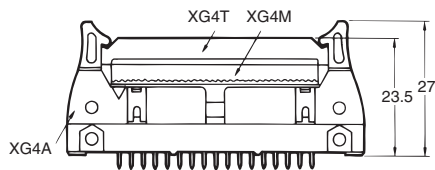

XG4T + XG4M, + XG4C + XG4Z Lock Lever

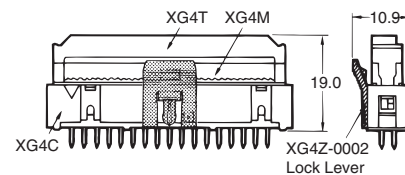

XG4U + XG4M + XG4C
(With right-angle terminals)

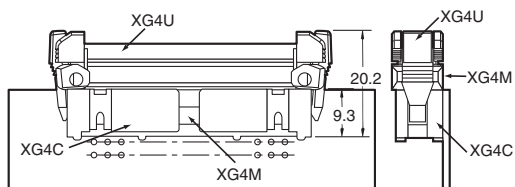

XG4T + XG4M + XG8 (Unshrouded Plug) + XG5Z Lock Lever

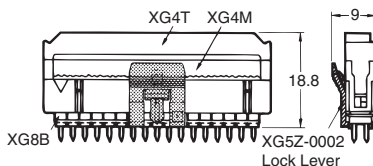

XG4T + XG4M + XG4E

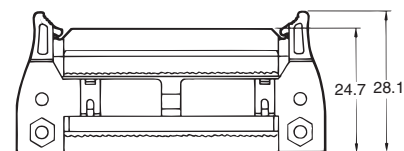

Cable Mount Connectors

■ XG4M-U Sockets (Uses XG4U Strain Relief with Lock Levers)

Dimensions

XG4U-□□04

Strain Reliefs with Locks

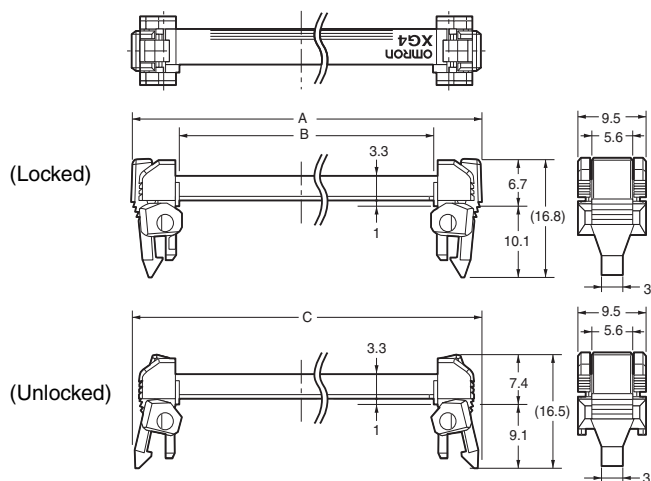

XG4M-□□30 (one polarity guide)

XG4M-□□31 (all others)

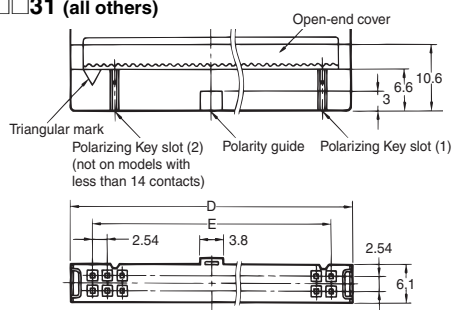

Mating Diagrams for XG4M-U

XG4U + XG4M + XG4C (with straight terminals)

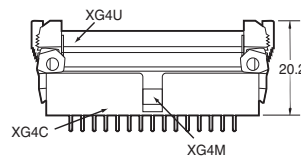

XG4U + XG4M + XG4C (with right-angle terminals)

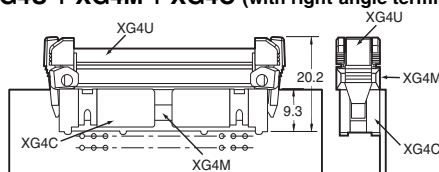

No. of contacts	Dimensions (mm)				
	A	B	C	D	E
10	26.8	13.2	26.2	17.3	10.16
14	31.8	18.2	31.2	22.3	15.24
16	34.4	20.8	33.8	24.9	17.78
20	39.5	25.9	38.9	30.0	22.86
26	47.1	33.5	46.5	37.6	30.48
30	52.2	38.6	51.6	42.7	35.56
34	57.2	43.6	56.6	47.7	40.64
40	64.9	51.3	64.3	55.4	48.26
50	77.6	64.0	77.0	68.1	60.96
60	90.3	76.7	89.7	80.8	73.66
64	95.3	81.7	94.7	85.8	78.74

Ordering Information

No. of contacts	No. of polarity guides	Socket+Strain Relief Sets (See notes 1 and 2.)	Socket with Open-end Cover (See note 3.)	Strain Relief with Locks
10	0	XG4M-1031-U	XG4M-1031	XG4U-1004
	1	XG4M-1030-U		
14	1	XG4M-1430-U	XG4M-1430	XG4U-1404
16	1	XG4M-1630-U	XG4M-1630	XG4U-1604
20	1	XG4M-2030-U	XG4M-2030	XG4U-2004
26	1	XG4M-2630-U	XG4M-2630	XG4U-2604
30	1	XG4M-3030-U	XG4M-3030	XG4U-3004
34	1	XG4M-3430-U	XG4M-3430	XG4U-3404
40	1	XG4M-4030-U	XG4M-4030	XG4U-4004
50	1	XG4M-5030-U	XG4M-5030	XG4U-5004
	2 (See note 4.)	XG4M-5031-U		
60	1	XG4M-6030-U	XG4M-6030	XG4U-6004
	2 (See note 4.)	XG4M-6031-U		
64	1	XG4M-6430-U	XG4M-6430	XG4U-6404
	2 (See note 4.)	XG4M-6431-U		

Note: 1. Sets include the connector and strain relief.
2. With open-end cover.

3. Strain Relief sold separately.
4. Polarity guide pitch is 22.86 mm.

■ XG4M-T Sockets (Uses XG4T Strain Relief without Lock Levers)

Dimensions

XG4M-□□30 (one polarizing guide)

XG4M-□□31 (all others)

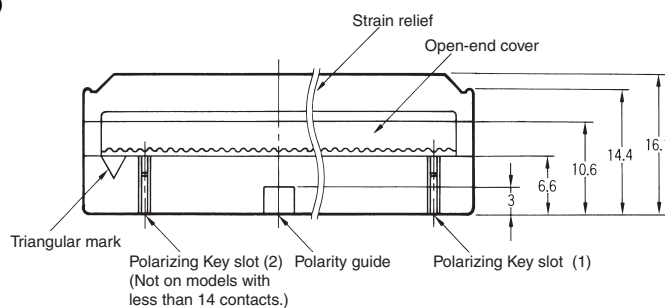
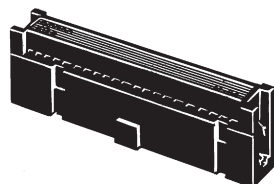

XG4T-□□04

Strain Relief

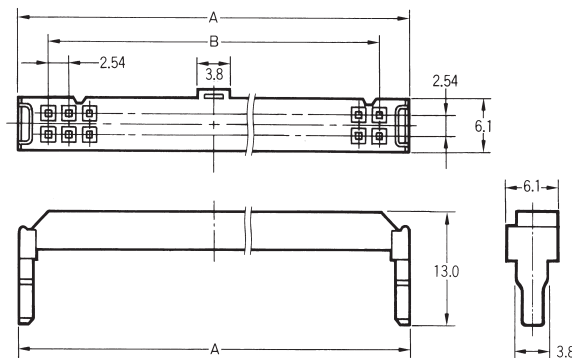
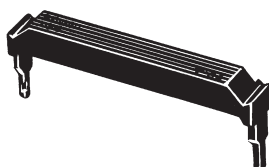

No of contacts	Dimensions (mm)	
	A	B
10	17.3	10.16
14	22.3	15.24
16	24.9	17.78
20	30.0	22.86
26	37.6	30.48
30	42.7	35.56
34	47.7	40.64
40	55.4	48.26
50	68.1	60.96
60	80.8	73.66
64	85.8	78.74

Ordering Information

No. of contacts	No. of polarity guides	Socket+Strain Relief Set (See notes 1 and 2.)	Socket with Open-end Cover (See note 3.)	Strain Relief for the XG4M
10	0			XG4T-1004
	1	XG4M-1031-T	XG4M-1031	
14	1	XG4M-1430-T	XG4M-1430	XG4T-1404
16	1	XG4M-1630-T	XG4M-1630	XG4T-1604
20	1	XG4M-2030-T	XG4M-2030	XG4T-2004
26	1	XG4M-2630-T	XG4M-2630	XG4T-2604
30	1	XG4M-3030-T	XG4M-3030	XG4T-3004
34	1	XG4M-3430-T	XG4M-3430	XG4T-3404
40	1	XG4M-4030-T	XG4M-4030	XG4T-4004
50	1	XG4M-5030-T	XG4M-5030	XG4T-5004
	2 (See note 4.)	XG4M-5031-T	XG4M-5031	
60	1	XG4M-6030-T	XG4M-6030	XG4T-6004
	2 (See note 4.)	XG4M-6031-T	XG4M-6031	
64	1	XG4M-6430-T	XG4M-6430	XG4T-6404
	2 (See note 4.)	XG4M-6431-T	XG4M-6431	

- Note:**
- Sets include the connector and strain relief.
 - With open-end cover.
 - Strain Relief sold separately.
 - Polarity guide pitch is 22.86 mm

■ XG4E Plugs and XG4S Strain Relief (Locking Levers on Connector)

Dimensions

XG4E-□□31/□□71

(With long locks)

XG4E-□□32/□□72

(With short locks)

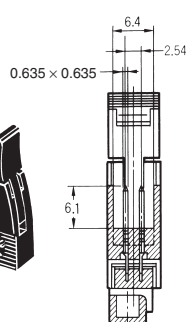
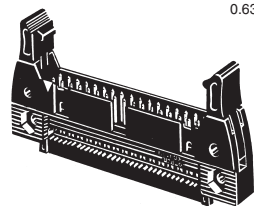

(Long locks)

(Short locks)

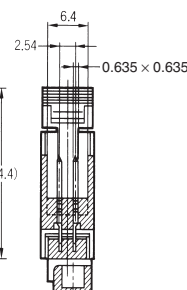
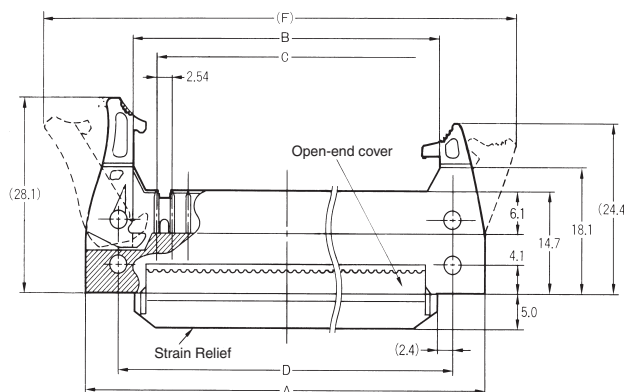

Two, 2.6 dia.
(M3 tapping screw hole)

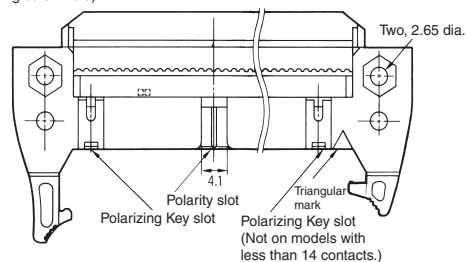

XG4S-□□04

Strain Relief

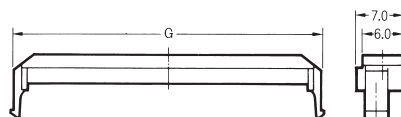

Dimensions

No. of contacts	Dimensions (mm)							
	A	B	C	D	E	F		G
						Long Lock	Short Lock	
10	32.0	17.5	10.16	21.8	27.9	46.4	40.4	16.9
14	37.1	22.6	15.24	26.9	33.0	51.5	45.5	22.0
16	39.6	25.2	17.78	29.5	35.6	54.1	46.0	24.6
20	44.7	30.2	22.86	34.5	40.6	59.1	53.1	29.6
26	52.3	37.9	30.48	42.2	48.3	66.8	60.7	38.0
30	57.4	42.9	35.56	47.2	53.3	71.8	65.8	42.3
34	62.5	48.0	40.64	52.3	58.4	76.9	70.9	47.4
40	70.1	55.6	48.26	59.9	66.0	84.5	78.5	55.0
50	82.8	68.3	60.96	72.6	78.7	97.2	91.2	67.7
60	95.5	81.0	73.66	85.3	91.4	109.9	103.9	80.4
64	100.6	86.1	78.74	90.4	96.5	115.0	109.0	85.5

Note: See the "Polarity Slot and Polarizing Key Slot Number and Position" section for details on the availability (10-contact Connectors) and pitch (with 50, 60, or 64-contact Connectors) of polarity slots.

Ordering Information

Use Long-lock Plugs to mate with XG4M-T Strain-relief Sockets, and use Short-lock Plugs to mate with XG4M that does not have a strain relief installed.

No. of contacts	No. of polarizing slots	Long-lock Plugs with Open-end Covers (See note 1.)	Short-lock Plugs with Open-end Covers (See note 1.)	Strain Reliefs for XG4E
10	0	XG4E-1071	XG4E-1072	XG4S-1004
	1	XG4E-1031	XG4E-1032	
14	1	XG4E-1431	XG4E-1432	XG4S-1404
16	1	XG4E-1631	XG4E-1632	XG4S-1604
20	1	XG4E-2031	XG4E-2032	XG4S-2004
26	1	XG4E-2631	XG4E-2632	XG4S-2604
30	1	XG4E-3031	XG4E-3032	XG4S-3004
34	1	XG4E-3431	XG4E-3432	XG4S-3404
40	1	XG4E-4031	XG4E-4032	XG4S-4004
50	1	XG4E-5031	XG4E-5032	XG4S-5004
	2 (See note 2.)	XG4E-5071	XG4E-5072	
60	1	XG4E-6031	XG4E-6032	XG4S-6004
	2 (See note 2.)	XG4E-6071	XG4E-6072	
64	1	XG4E-6431	XG4E-6432	XG4S-6404
	2 (See note 2.)	XG4E-6471	XG4E-6472	

- Note:** 1. Strain Relief sold separately.
 2. Polarity slot pitch is 22.86 mm.

Cable Numbers and Contact Position

Cable and Corresponding Contact Number

The contact numbers are not marked on the Connector. Use the triangular mark as a guide when wiring and designing circuit boards.

For the cable number, count starting from the cable mark side as shown on the right.

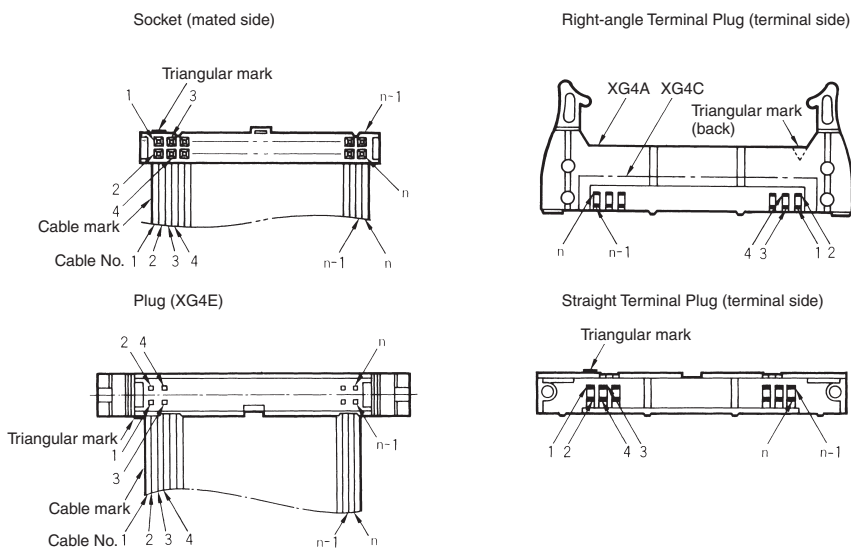

PCB Mount Connectors

■ XG4A Plugs with Long Lock levers

Dimensions

XG4A-□□31/-□□71 (With straight DIP terminals)

XG4A-□□34/-□□74 (With right-angle DIP terminals)

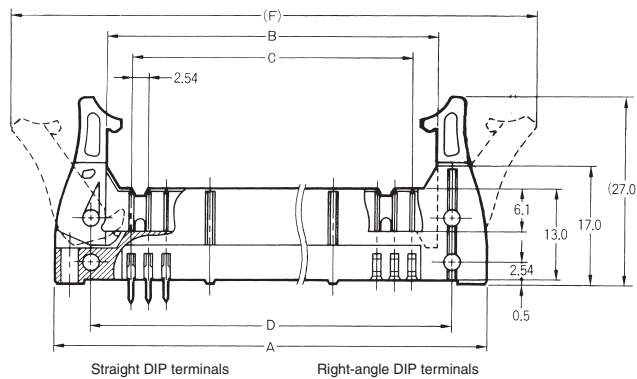
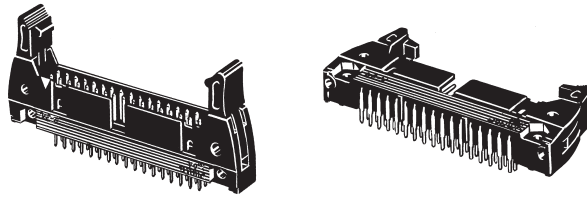

Straight DIP terminals

Right-angle DIP terminals

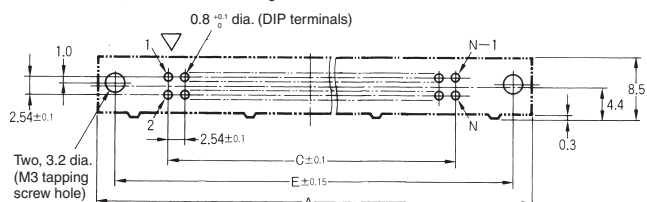
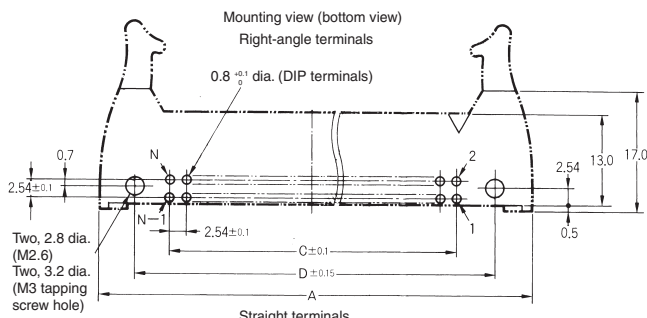
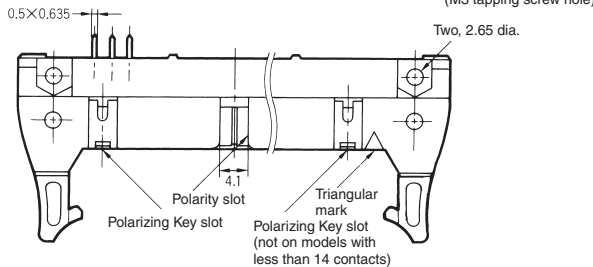
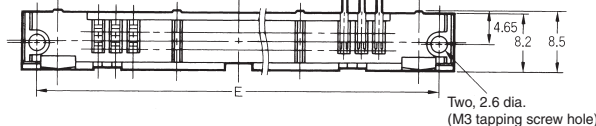
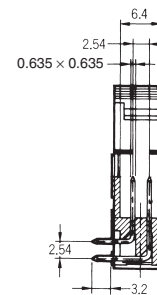
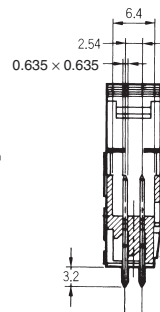

No. of contacts	Dimensions (mm)					
	A	B	C	D	E	F
10	32.0	17.5	10.16	21.8	27.9	46.4
14	37.1	22.6	15.24	26.9	33.0	51.5
16	39.6	25.2	17.78	29.5	35.6	54.1
20	44.7	30.2	22.86	34.5	40.6	59.1
26	52.3	37.9	30.48	42.2	48.3	66.8
30	57.4	42.9	35.56	47.2	53.3	71.8
34	62.5	48.0	40.64	52.3	58.4	76.9
40	70.1	55.6	48.26	59.9	66.0	84.5
50	82.8	68.3	60.96	72.6	78.7	97.2
60	95.5	81.0	73.66	85.3	91.4	109.9
64	100.6	86.1	78.74	90.4	96.5	115.0

Note: See the "Polarity Slot and Polarizing Key Slot Number and Position" section for details on the availability (10-contact Connectors) and pitch (with 50, 60, or 64-contact Connectors) of polarity slots.

Ordering Information

Use in Combination with XG4M-T cable mount Sockets with strain relief or XG5M Sockets for discrete wire.

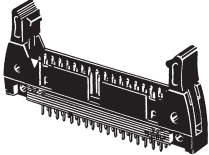
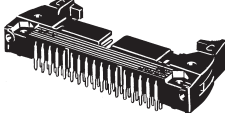
No. of contacts	No. of polarizing slots	Plugs with straight DIP terminals	Plugs with right-angle DIP terminals
			
10	0	XG4A-1071	XG4A-1074
	1	XG4A-1031	XG4A-1034
14	1	XG4A-1431	XG4A-1434
16	1	XG4A-1631	XG4A-1634
20	1	XG4A-2031	XG4A-2034
26	1	XG4A-2631	XG4A-2634
30	1	XG4A-3031	XG4A-3034
34	1	XG4A-3431	XG4A-3434
40	1	XG4A-4031	XG4A-4034
50	1	XG4A-5031	XG4A-5034
	2 (See note.)	XG4A-5071	XG4A-5074
60	1	XG4A-6031	XG4A-6034
	2 (See note.)	XG4A-6071	XG4A-6074
64	1	XG4A-6431	XG4A-6434
	2 (See note.)	XG4A-6471	XG4A-6474

Note: Polarizing slot pitch is 22.86 mm.

■ XG4A Plugs with Short Locks

Dimensions

XG4A-□□32/-□□72 (With straight DIP terminals)

XG4A-□□35/-□□75 (With right-angle DIP terminals)

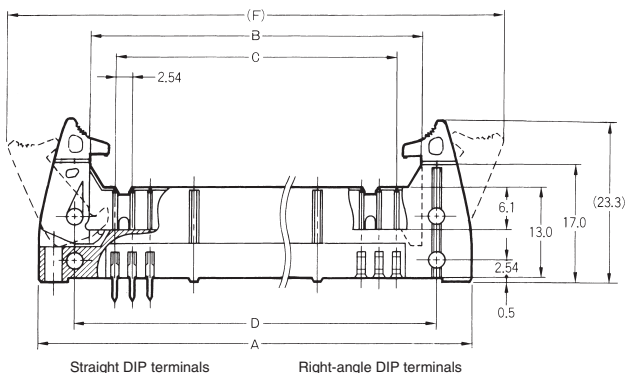
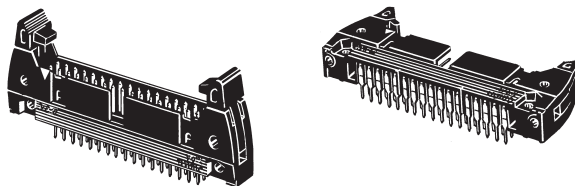

Straight DIP terminals

Right-angle DIP terminals

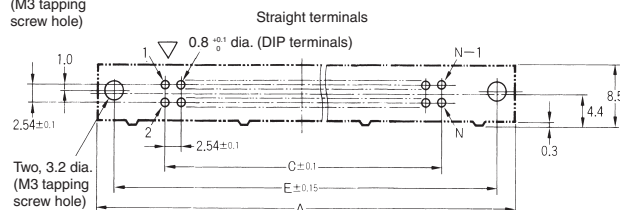
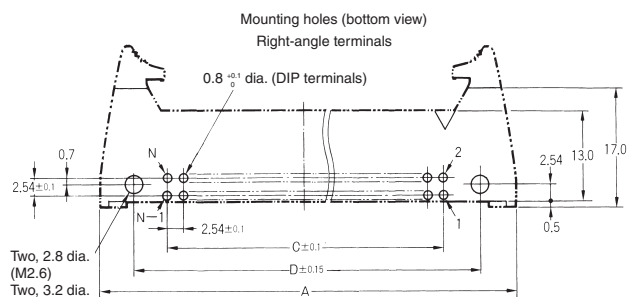
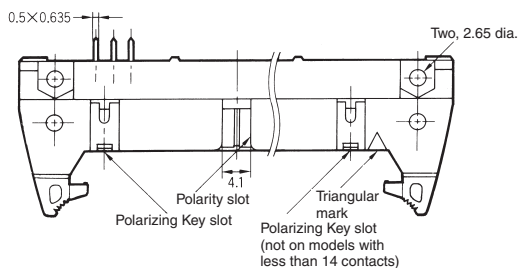
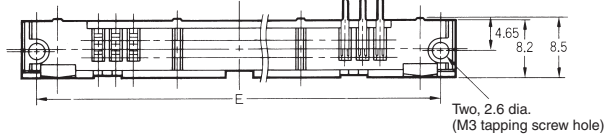
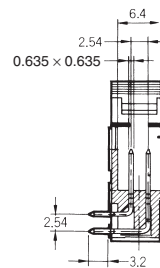
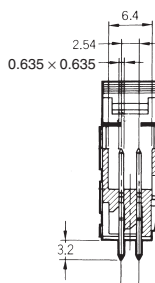

No. of contacts	Dimensions (mm)					
	A	B	C	D	E	F
10	32.0	17.5	10.16	21.8	27.9	40.4
14	37.1	22.6	15.24	26.9	33.0	45.5
16	39.6	25.2	17.78	29.5	35.6	48.0
20	44.7	30.2	22.86	34.5	40.6	53.1
26	52.3	37.9	30.48	42.2	48.3	60.7
30	57.4	42.9	35.56	47.2	53.3	65.8
34	62.5	48.0	40.64	52.3	58.4	70.9
40	70.1	55.6	48.26	59.9	66.0	78.5
50	82.8	68.3	60.96	72.6	78.7	91.2
60	95.5	81.0	73.66	85.3	91.4	103.9
64	100.6	86.1	78.74	90.4	96.5	109.0

Note: See the "Polarity Slot and Polarizing Key Slot Number and Position" section for details on the availability (10-contact Connectors) and pitch (with 50, 60, or 64-contact Connectors) of polarity slots.

Ordering Information

Use in Combination with XG4M cable mount Sockets without strain relief.

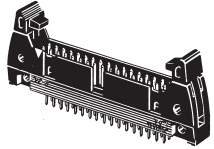
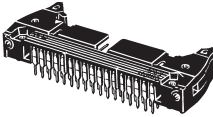
No. of contacts	No. of polarizing slots	Plugs with straight DIP terminals 	Plugs with right-angle DIP terminals 
10	0	XG4A-1072	XG4A-1075
	1	XG4A-1032	XG4A-1035
14	1	XG4A-1432	XG4A-1435
16	1	XG4A-1632	XG4A-1635
20	1	XG4A-2032	XG4A-2035
26	1	XG4A-2632	XG4A-2635
30	1	XG4A-3032	XG4A-3035
34	1	XG4A-3432	XG4A-3435
40	1	XG4A-4032	XG4A-4035
50	1	XG4A-5032	XG4A-5035
	2 (See note.)	XG4A-5072	XG4A-5075
60	1	XG4A-6032	XG4A-6035
	2 (See note.)	XG4A-6072	XG4A-6075
64	1	XG4A-6432	XG4A-6435
	2 (See note.)	XG4A-6472	XG4A-6475

Note: Polarizing slot pitch is 22.86 mm.

■ XG4A Plugs without Lock Levers

Note: XG4Z-001□ Lock Levers that can be installed after PCB assembly may be purchased separately. (See the following page.)

Dimensions

XG4A-□□33/-□□73 (With straight DIP terminals)

XG4A-□□36/-□□76 (With right-angle DIP terminals)

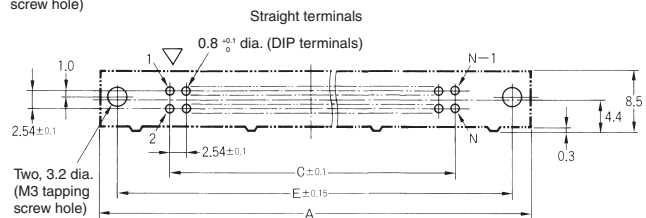
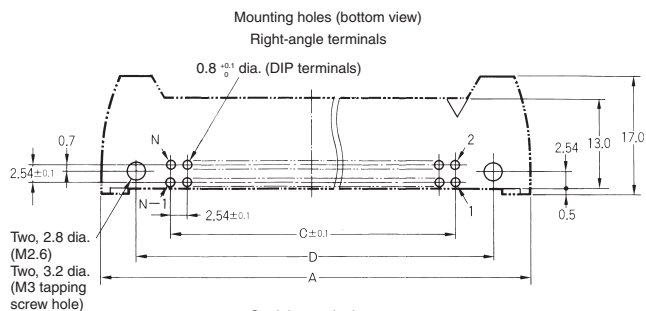
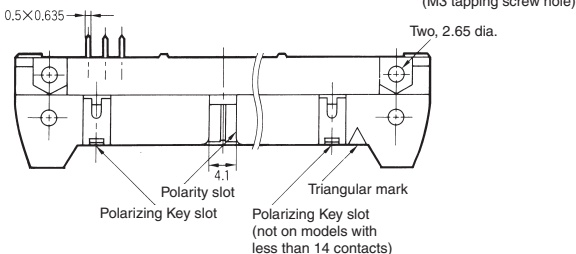
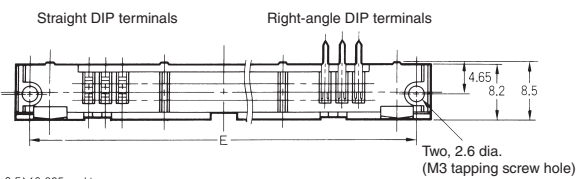
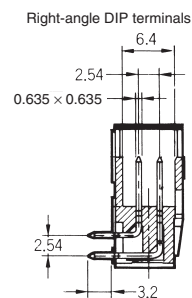
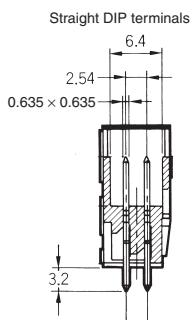
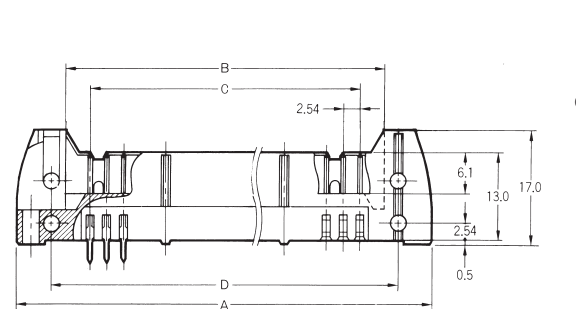
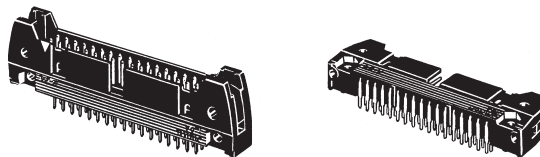

No. of contacts	Dimensions (mm)				
	A	B	C	D	E
10	32.0	17.5	10.16	21.8	27.9
14	37.1	22.6	15.24	26.9	33.0
16	39.6	25.2	17.78	29.5	35.6
20	44.7	30.2	22.86	34.5	40.6
26	52.3	37.9	30.48	42.2	48.3
30	57.4	42.9	35.56	47.2	53.3
34	62.5	48.0	40.64	52.3	58.4
40	70.1	55.6	48.26	59.9	66.0
50	82.8	68.3	60.96	72.6	78.7
60	95.5	81.0	73.66	85.3	91.4
64	100.6	86.1	78.74	90.4	96.5

Note: See the "Polarity Slot and Polarizing Key Slot Number and Position" section for details on the availability (10-contact Connectors) and pitch (with 50, 60, or 64-contact Connectors) of polarity slots.

Ordering Information

No. of contacts	No. of polarizing slots	Plugs with straight DIP terminals	Plugs right-angle DIP terminals
10	0	XG4A-1073	XG4A-1076
	1	XG4A-1033	XG4A-1036
14	1	XG4A-1433	XG4A-1436
16	1	XG4A-1633	XG4A-1636
20	1	XG4A-2033	XG4A-2036
26	1	XG4A-2633	XG4A-2636
30	1	XG4A-3033	XG4A-3036
34	1	XG4A-3433	XG4A-3436
40	1	XG4A-4033	XG4A-4036
50	1	XG4A-5033	XG4A-5036
	2 (See note.)	XG4A-5073	XG4A-5076
60	1	XG4A-6033	XG4A-6036
	2 (See note.)	XG4A-6073	XG4A-6076
64	1	XG4A-6433	XG4A-6436
	2 (See note.)	XG4A-6473	XG4A-6476

Note: Polarity slot pitch is 22.86 mm.

Lock Levers for XG4A-□□3□/7□

Attachment after Soldering

- Long Levers interfere with automated mounting.
 - Long Levers are in the way when boards are packed.
- ↓
- These problems are resolved using Connectors with Long Levers that can be attached after soldering is completed.

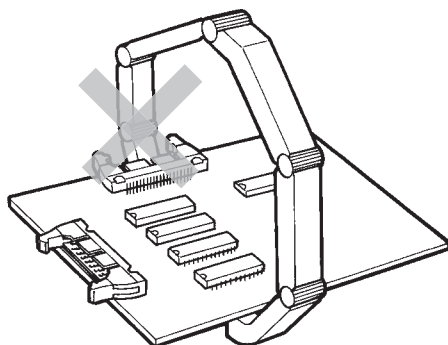

- These versions of the XG4A connector allows you to attach Lock Levers on Right-angle Terminal Plugs after automated soldering is completed.
- Lock Levers can be easily mounted simply by manually pushing them in.
- Lock Levers can be used with either Straight or Right Angle versions of the XG4A.

Ordering Information



Type	Model	Min. order
Long Lock Levers	XG4Z-0010	20
Short Lock Levers	XG4Z-0011	
Slim Long Lock Levers	XG4Z-0012	
Slim Short Lock Levers	XG4Z-0013	

- Note: 1. The left and right Lock Levers are identical. One pair is needed for each Plug.
2. Use Long Lock Levers when mating XG4A plug to XG4M-T cable mount socket with strain relief or XG5M sockets for discrete wires.
 3. Use Short Lock Levers when mating XG4A plug to XG4M without strain relief attached.

■ XG4A 2-tier Plugs with Long Lock Lever

Dimensions

XG4A-□□39-A/-□□79-A

(With long locks and right-angle DIP terminals)

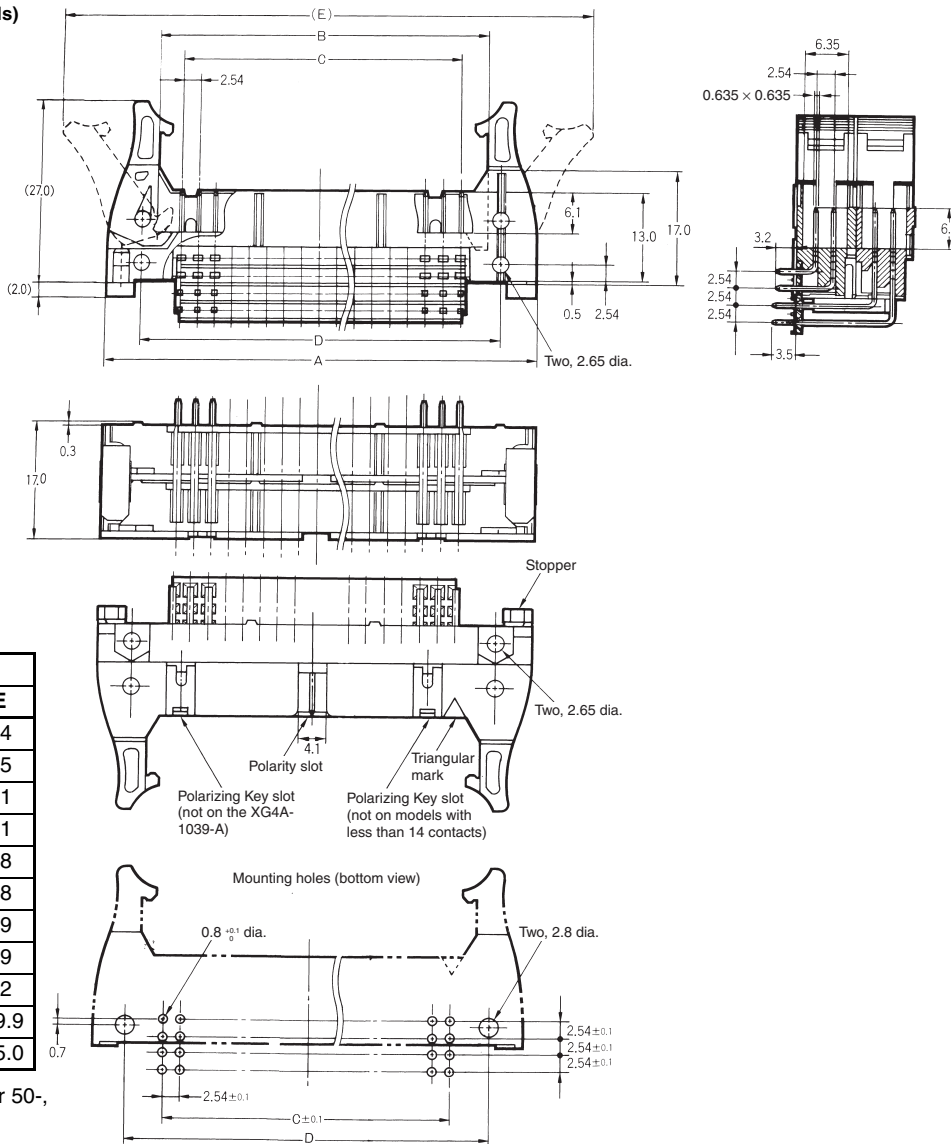
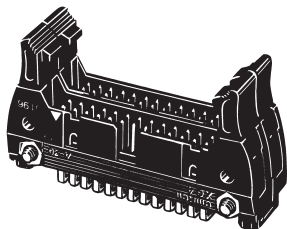

No. of contacts	Dimensions (mm)				
	A	B	C	D	E
10 × 2	32.0	17.5	10.16	21.8	46.4
14 × 2	37.1	22.6	15.24	26.9	51.5
16 × 2	39.6	25.2	17.78	29.5	54.1
20 × 2	44.7	30.2	22.86	34.5	59.1
26 × 2	52.3	37.9	30.48	42.2	66.8
30 × 2	57.4	42.9	35.56	47.2	71.8
34 × 2	62.5	48.0	40.64	52.3	76.9
40 × 2	70.1	55.6	48.26	59.9	84.9
50 × 2	82.8	68.3	60.96	72.6	97.2
60 × 2	95.5	81.0	73.66	85.3	109.9
64 × 2	100.6	86.1	78.74	90.4	115.0

Note: Polarizing slot pitch is 22.86 mm for 50-, 60-, and 64-contact Connectors.

Ordering Information

No. of contacts	No. of polarizing slots	Model	No. of contacts	No. of polarity slots	Model
10 × 2	0	XG4A-1079-A	40 × 2	1	XG4A-4039-A
	1	XG4A-1039-A			
14 × 2	1	XG4A-1439-A	50 × 2	1	XG4A-5039-A
16 × 2	1	XG4A-1639-A			
20 × 2	1	XG4A-2039-A	60 × 2	1	XG4A-6039-A
26 × 2	1	XG4A-2639-A			
30 × 2	1	XG4A-3039-A	64 × 2	1	XG4A-6439-A
34 × 2	1	XG4A-3439-A			
				2 (See note 2.)	XG4A-6479-A

Note: 1. Comes in a set with stopper and screws included.

2. Polarizing slot pitch is 22.86 mm.

Mounting Example

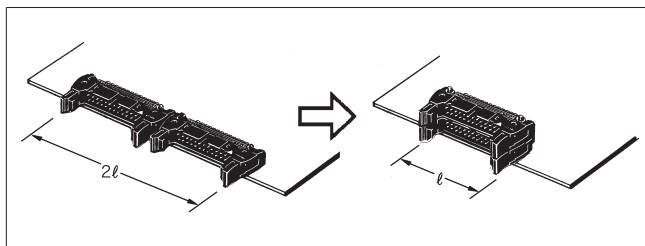

2-tier Plug Features

- Recommended for high-density mounting.
- MIL-compliant cable ensures faster delivery times and lower cost than half-pitch board cable. The 2.54-mm pitch simplifies patterning.

Applicable Mating Sockets

No. of contacts	No. of polarity slots	2-tier Plug Model No.	Mating Socket	
			XG4M for flat cable (See note 1.)	XG5M-N for discrete wire (See note 2.)
10 × 2	0	XG4A-1079-A	XG4M-1031	XG5M-103□-N
	1	XG4A-1039-A	XG4M-1030	XG5M-103□-N
14 × 2	1	XG4A-1439-A	XG4M-1430	XG5M-143□-N
16 × 2	1	XG4A-1639-A	XG4M-1630	XG5M-163□-N
20 × 2	1	XG4A-2039-A	XG4M-2030	XG5M-203□-N
26 × 2	1	XG4A-2639-A	XG4M-2630	XG5M-263□-N
30 × 2	1	XG4A-3039-A	XG4M-3030	XG5M-303□-N
34 × 2	1	XG4A-3439-A	XG4M-3430	XG5M-343□-N
40 × 2	1	XG4A-4039-A	XG4M-4030	XG5M-403□-N
50 × 2	1	XG4A-5039-A	XG4M-5030	XG5M-503□-N
	2 (See note 3.)	XG4A-5079-A	XG4M-5031	
60 × 2	1	XG4A-6039-A	XG4M-6030	XG5M-603□-N
	2 (See note 3.)	XG4A-6079-A	XG4M-6031	
64 × 2	1	XG4A-6439-A	XG4M-6430	XG5M-643□-N
	2 (See note 3.)	XG4A-6479-A	XG4M-6431	

- Note:**
1. Use with the XG4T strain relief. (XG4M-T includes the connector and strain relief as a set.)
 2. Use with the XG5S Semi-cover. XG5S Hood Cover cannot be used. (See XG5 Datasheet).
 3. Polarity slot pitch is 22.86 mm.

Cable Number and Contact Position

• Cable and Corresponding Contact Number

The contact numbers are not marked on the Connector. Use the triangular mark as a guide when wiring and designing circuit boards.

For the cable number, count starting from the cable mark side as shown below.

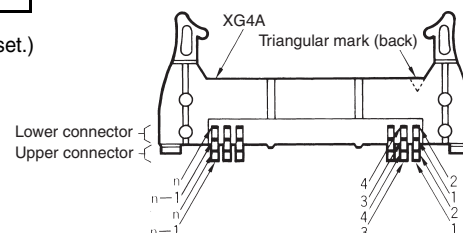
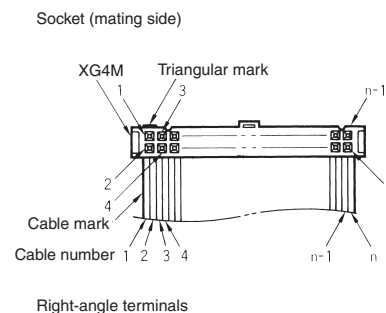

Correct Use of XG4A 2-tier Plug

Mounting

- Be sure to anchor the board with screws before mounting.
- Note that a Polarizing Key cannot be mounted on the lower Plug.

Connecting the Socket

- Before connecting the XG4M with Strain Relief, remove as much slack from the cable as possible. Insert as shown below.
- Attach an XG5S Semi-cover before connecting the XG5M-N. It is not possible to use an XG5S Hood Cover. (See XG5 Datasheet)

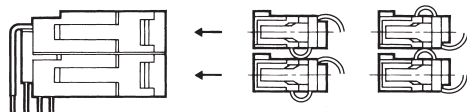

Soldering

- Automated Soldering Conditions (Jet Flow)

 1. Soldering temperature: 250 ±5°C
 2. Continuous soldering time: Within 5 s

■ XG4C Box-type (Shrouded) Plugs

Note: See XG8 Datasheet for unshrouded PCB plugs / headers that mate with the XG4M-T cable mount sockets.

Dimensions

XG4C-□□31/-□□71
(With straight DIP terminals)

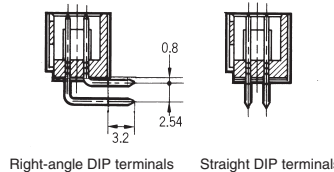
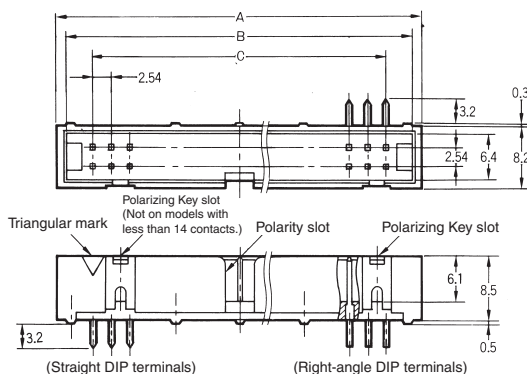
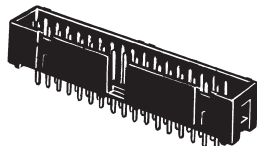

Right-angle DIP terminals Straight DIP terminals

No. of contacts	Dimensions (mm)		
	A	B	C
10	20.0	17.5	10.16
14	25.1	22.6	15.24
16	27.6	25.2	17.78
20	32.7	30.2	22.86
26	40.3	37.9	30.48
30	45.4	42.9	35.56
34	50.5	48.0	40.64
40	58.1	55.6	48.26
50	70.8	68.3	60.96
60	83.5	81.0	73.66
64	88.6	86.1	78.74

Note: See the "Polarity Slot and Polarizing Key Slot Number and Position" section for details on the availability (10-contact Connectors) and pitch (with 50, 60, or 64-contact Connectors) of polarity slots.

XG4C-□□34/-□□74
(With right-angle DIP terminals)

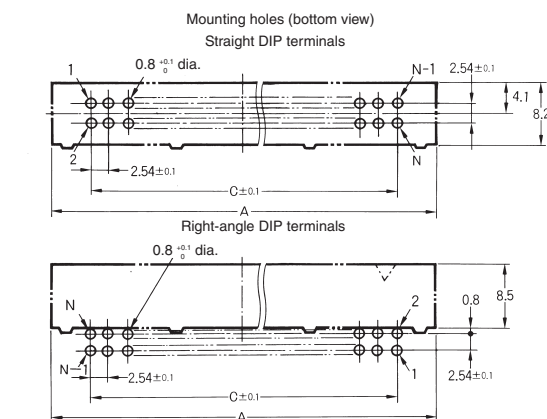
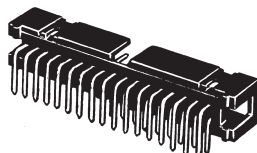

Ordering Information

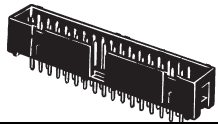
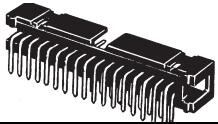
No. of contacts	No. of polarizing slots	Plugs with straight DIP terminals	Plugs with right-angle DIP terminals
			
10	0	XG4C-1071	XG4C-1074
	1	XG4C-1031	XG4C-1034
14	1	XG4C-1431	XG4C-1434
16	1	XG4C-1631	XG4C-1634
20	1	XG4C-2031	XG4C-2034
26	1	XG4C-2631	XG4C-2634
30	1	XG4C-3031	XG4C-3034
34	1	XG4C-3431	XG4C-3434
40	1	XG4C-4031	XG4C-4034
50	1	XG4C-5031	XG4C-5034
	2 (See note 1.)	XG4C-5071	XG4C-5074
60	1	XG4C-6031	XG4C-6034
	2 (See note 1.)	XG4C-6071	XG4C-6074
64	1	XG4C-6431	XG4C-6434
	2 (See note 1.)	XG4C-6471	XG4C-6474

Note: 1. Polarizing slot pitch is 22.86 mm.

2. The Box-type Plug can be locked to XG4M and XG5 using the "XG4Z-0002" Lock Lever II (sold separately).

■ XG4H Board-to-Board Sockets

Dimensions

XG4H-□□31/-□□71
(With straight DIP terminals)

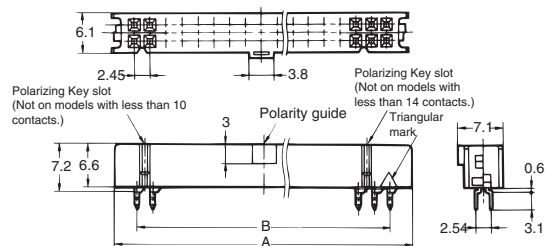

XG4H-3431-1
XG4H-4031-1
(With straight DIP terminals)

*Sockets with model numbers ending in -1 are available only with 34 or 40 contacts (provide kinked terminals and standoff to prevent the Sockets from falling over).

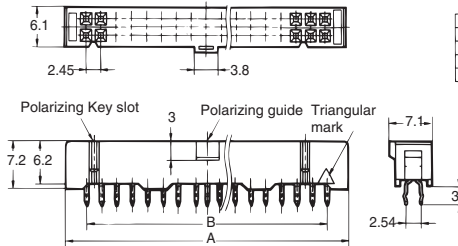

Mounting holes (bottom view)

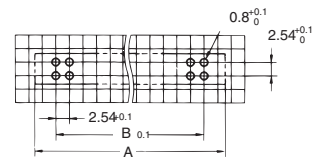

XG4H-4034
(With right-angle DIP terminals)

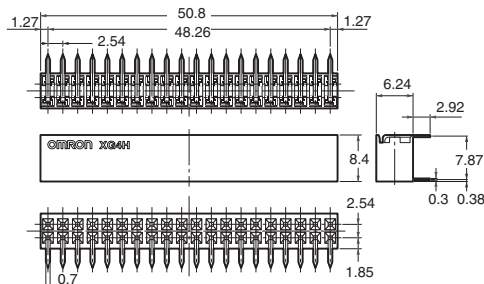

Mounting holes (bottom view)

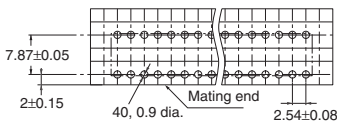

Dimensions

No. of contacts	A	B
10	17.3	10.16
14	22.3	15.24
16	24.9	17.78
20	30.0	22.86
26	37.6	30.48
30	42.7	35.56
34	47.7	40.64
40	55.4	48.26
50	68.1	60.96
60	80.8	73.66
64	85.8	78.74

Ordering Information

No. of contacts	No. of polarizing slots	Sockets with straight DIP terminals
10	1	XG4H-1031
14	1	XG4H-1431
16	1	XG4H-1631
20	1	XG4H-2031
26	1	XG4H-2631
30	1	XG4H-3031
34	1	XG4H-3431-1
40	1	XG4H-4031-1
50	1	XG4H-5031
	2 (See note.)	XG4H-5071
60	1	XG4H-6031
	2 (See note.)	XG4H-6071
64	1	XG4H-6431
	2 (See note.)	XG4H-6471











No. of contacts	Sockets with right-angle DIP terminals
40	XG4H-4034

Note: Polarizing guide pitch is 22.86 mm.

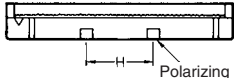
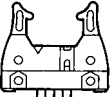
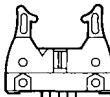
■ Mating Diagrams for XG4H

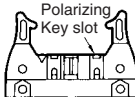
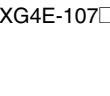
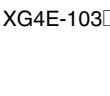
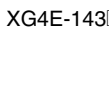
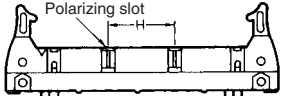
Plug	XG8W Original Plugs (See XG8 Datasheet)	XG4C Box-type Plugs
Socket XG4H-□□31/-□□71 (With straight DIP terminals)		
XG4H-4034 (With right-angle DIP terminals)		<p style="text-align: center;">—</p>

Polarity Slot and Polarizing Key Slot Number and Position

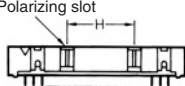
Classification	No. of contacts				
	10 contacts		14 contacts	16 to 40 contacts	50 to 64 contacts
XG4M Cable Socket	XG4M-1031 	XG4M-1030 	XG4M-1430 	—	XG4M-1630 to XG4M-6430  Polarizing Key slot
					XG4M-5031, XG4M-6031, XG4M-6431  Polarizing guide
XG4A PCB Plug XG4E Cable Plug	XG4A-107□ 	XG4A-103□ 	XG4A-143□ 	—	XG4A-163□ to XG4A-643□  Polarizing Key slot
	XG4E-107□ 	XG4E-103□ 	XG4E-143□ 		XG4E-163□ to XG4E-643□  Polarizing slot
XG4C Box-type PCB Plug	XG4C-107□ 	XG4C-103□ 	XG4C-143□ 	—	XG4C-163□ to XG4C-643□  Polarizing slot
					XG4C-507□, XG4C-607□, XG4C-647□  Polarizing slot
No. of polarizing guides (Polarizing Slots)	0	1	1	1	1
No. of Polarizing Key slot (Polarizing Key Slots)	1	0	1	2	2

Tools and Accessories (Sold Separately)

See "XG□ - Assembly Tooling and Accessories" datasheet from additional information about cable termination tooling.

External Polarization Options

The following optional accessories can be used to provide polarization to sockets and plugs that do not have molded polarizing guides and slots built into their housings and shrouds.

Solutions for Shrouded Connectors

XG4Z-0004 Polarizing Key

Typically, 10 contact versions of the XG4A, XG4E and XG4C are available with or without polarizing guides.

Install the XG4Z-0004 polarizing key on XG4A, XG4E and XG4C plugs that do not have a polarizing slot, to prevent reverse connection with XG4M cable sockets that do not have a polarizing guide.

For all other versions, the molded polarity guides and slots can be used by themselves to help prevent reverse insertion. However, use the polarizing key with these versions as well for best results.

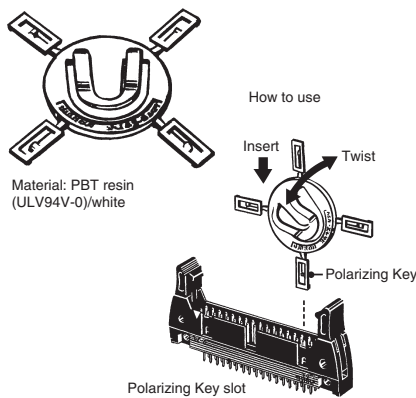

Note: Each XG4Z-0004 has 4 Polarizing Keys.

Solutions for Unshrouded Connectors

Use the XG4Z-0005 coding pin to fill a specific hole in one of the XG4 or XG5 sockets. Then, use the XY2E-0002 cutting pin to remove the corresponding terminal from an XG8 unshrouded plug. (See XG5 and XG8 datasheets for details about those connectors.)

XG4Z-0005 Coding Pin

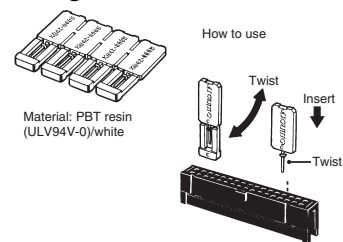

Note: 1. A contact with a Coding Pin inserted cannot be used.
2. Each XG4Z-0005 has 4 Polarizing Keys.

XY2E-0002 Contact Cutting Driver

The Contact Cutting Driver is used to cut (twist off) a contact on the mating Plug when using an XG4Z-0005 Coding Pin.

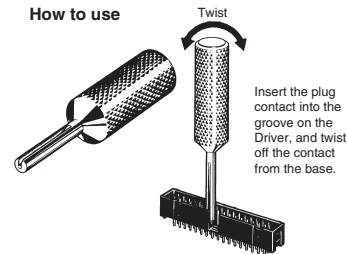

Top Lock Levers

XG5Z-0002 - "Lock Lever"

Use to lock right angle XG8B and XG8W Plugs to mating sockets

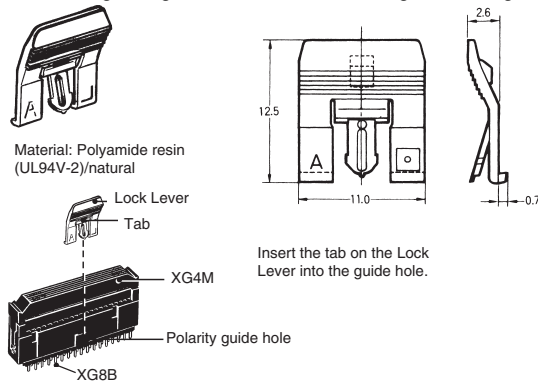

XG4Z-0002 - "Lock Lever II"

Use to lock XG4C Box-type Plugs to mating sockets.

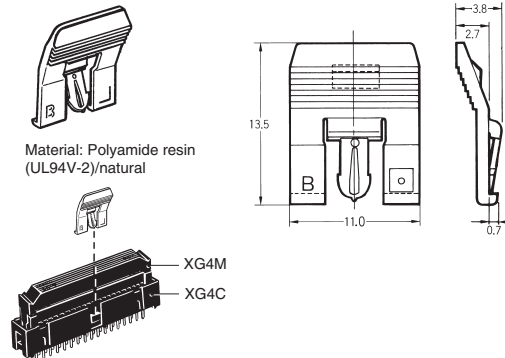

Precautions - PCB Mount Sockets and Plugs

Correct Use

Automated Soldering Conditions (Jet Flow)

1. Soldering temperature: 250 ±5°C
2. Continuous soldering time: Within 5 s

Note: The coding pin and cutting tools can also be used to prevent incorrect wiring by removing different terminals from side-by-side connectors. For example, for connector set 1, remove terminal 1 and fill socket hole 1. Then, for connector set 2, remove terminal 2 and fill socket hole 2. This prevents socket 1 from mating with plug 2, ensuring correct wiring.



All sales are subject to Omron Electronic Components LLC standard terms and conditions of sale, which can be found at http://www.components.omron.com/components/web/webfiles.nsf/sales_terms.html

ALL DIMENSIONS SHOWN ARE IN MILLIMETERS.

To convert millimeters into inches, multiply by 0.03937. To convert grams into ounces, multiply by 0.03527.

OMRON[®]

**OMRON ELECTRONIC
COMPONENTS LLC**

55 E. Commerce Drive, Suite B
Schaumburg, IL 60173

847-882-2288

OMRON ON-LINE

Global - <http://www.omron.com>

USA - <http://www.components.omron.com>

Компания «Life Electronics» занимается поставками электронных компонентов импортного и отечественного производства от производителей и со складов крупных дистрибьюторов Европы, Америки и Азии.

С конца 2013 года компания активно расширяет линейку поставок компонентов по направлению коаксиальный кабель, кварцевые генераторы и конденсаторы (керамические, пленочные, электролитические), за счёт заключения дистрибьюторских договоров

Мы предлагаем:

- Конкурентоспособные цены и скидки постоянным клиентам.
- Специальные условия для постоянных клиентов.
- Подбор аналогов.
- Поставку компонентов в любых объемах, удовлетворяющих вашим потребностям.
- Приемлемые сроки поставки, возможна ускоренная поставка.
- Доставку товара в любую точку России и стран СНГ.
- Комплексную поставку.
- Работу по проектам и поставку образцов.
- Формирование склада под заказчика.
- Сертификаты соответствия на поставляемую продукцию (по желанию клиента).
- Тестирование поставляемой продукции.
- Поставку компонентов, требующих военную и космическую приемку.
- Входной контроль качества.
- Наличие сертификата ISO.

В составе нашей компании организован Конструкторский отдел, призванный помогать разработчикам, и инженерам.

Конструкторский отдел помогает осуществить:

- Регистрацию проекта у производителя компонентов.
- Техническую поддержку проекта.
- Защиту от снятия компонента с производства.
- Оценку стоимости проекта по компонентам.
- Изготовление тестовой платы монтаж и пусконаладочные работы.



Тел: +7 (812) 336 43 04 (многоканальный)

Email: org@lifeelectronics.ru