

BGS12S3N6

Wideband RF SPDT Switch in ultra small package with 0.64mm² footprint

Data Sheet

Revision 1.4, 2016-06-06

Edition June 6, 2016

**Published by
Infineon Technologies AG
81726 Munich, Germany**

**©2011 Infineon Technologies AG
All Rights Reserved.**

Legal Disclaimer

The information given in this document shall in no event be regarded as a guarantee of conditions or characteristics. With respect to any examples or hints given herein, any typical values stated herein and/or any information regarding the application of the device, Infineon Technologies hereby disclaims any and all warranties and liabilities of any kind, including without limitation, warranties of non-infringement of intellectual property rights of any third party.

Information

For further information on technology, delivery terms and conditions and prices, please contact the nearest Infineon Technologies Office (www.infineon.com).

Warnings

Due to technical requirements, components may contain dangerous substances. For information on the types in question, please contact the nearest Infineon Technologies Office.

Infineon Technologies components may be used in life-support devices or systems only with the express written approval of Infineon Technologies, if a failure of such components can reasonably be expected to cause the failure of that life-support device or system or to affect the safety or effectiveness of that device or system. Life support devices or systems are intended to be implanted in the human body or to support and/or maintain and sustain and/or protect human life. If they fail, it is reasonable to assume that the health of the user or other persons may be endangered.

Revision History

Document No.: BGS12S3N6.pdf	
Previous Version: Preliminary, Revision v1.3 - 2015-11-11	
Page	Subjects (major changes since last revision)
10-11	Update RF Characteristics
13-14	Update and include Package Information

Trademarks of Infineon Technologies AG

AURIX™, C166™, CanPAK™, CIPOS™, CIPURSE™, CoolGaN™, CoolMOS™, CoolSET™, CoolSiC™, CORECONTROL™, DAVE™, DI-POL™, EasyPIM™, EconoBRIDGE™, EconoDUAL™, EconoPACK™, EconoPIM™, EiceDRIVER™, eupec™, FCOS™, HITFET™, HybridPACK™, ISOFACE™, I²RF™, IsoPACK™, MIPAQ™, ModSTACK™, my-d™, NovalithIC™, OmniTune™, OptiMOS™, ORIGA™, OPTIGA™, PROFET™, PRO-SIL™, PRIMARION™, PrimePACK™, RASIC™, ReverSave™, SatRIC™, SIEGET™, SIPMOS™, SOLID FLASH™, SmartLEWIS™, TEMPFET™, thinQ!™, TriCore™, TRENCHSTOP™.

Other Trademarks

Advance Design System™ (ADS) of Agilent Technologies, AMBA™, ARM™, MULTI-ICE™, PRIMECELL™, REALVIEW™, THUMB™ of ARM Limited, UK. AUTOSAR™ is licensed by AUTOSAR development partnership. Bluetooth™ of Bluetooth SIG Inc. CAT-iq™ of DECT Forum. COLOSSUS™, FirstGPS™ of Trimble Navigation Ltd. EMV™ of EMVCo, LLC (Visa Holdings Inc.). EPCOS™ of Epcos AG. FLEXGO™ of Microsoft Corporation. FlexRay™ is licensed by FlexRay Consortium. HYPERTERMINAL™ of Hilgraeve Incorporated. IEC™ of Commission Electrotechnique Internationale. IrDA™ of Infrared Data Association Corporation. ISO™ of INTERNATIONAL ORGANIZATION FOR STANDARDIZATION. MATLAB™ of MathWorks, Inc. MAXIM™ of Maxim Integrated Products, Inc. MICROTEC™, NUCLEUS™ of Mentor Graphics Corporation. Mifare™ of NXP. MIPI™ of MIPI Alliance, Inc. MIPS™ of MIPS Technologies, Inc., USA. muRata™ of MURATA MANUFACTURING CO., MICROWAVE OFFICE™ (MWO) of Applied Wave Research Inc., OmniVision™ of OmniVision Technologies, Inc. Openwave™ Openwave Systems Inc. RED HAT™ Red Hat, Inc. RFMD™ RF Micro Devices, Inc. SIRIUS™ of Sirius Sattelite Radio Inc. SOLARIS™ of Sun Microsystems, Inc. SPANSION™ of Spansion LLC Ltd. Symbian™ of Symbian Software Limited. TAIYO YUDEN™ of Taiyo Yuden Co. TEAKLITE™ of CEVA, Inc. TEKTRONIX™ of Tektronix Inc. TOKO™ of TOKO KABUSHIKI KAISHA TA. UNIX™ of X/Open Company Limited. VERILOG™, PALLADIUM™ of Cadence Design Systems, Inc. VLYNQ™ of Texas Instruments Incorporated. VXWORKS™, WIND RIVER™ of WIND RIVER SYSTEMS, INC. ZETEX™ of Diodes Zetex Limited.

Last Trademarks Update 2012-12-13

Contents

1 Features	7
2 Product Description	7
3 Maximum Ratings	9
4 Operation Ranges	9
5 RF Characteristics	10
6 Pin Description	12
7 Package Information	12

List of Figures

1	BGS12S3N6 Block Diagram	8
2	Pin Configuration	12
3	Package Outline	13
4	Footprint	13
5	Pin 1 Marking (top view)	14
6	Tape Drawing for TSNP6-6	14

List of Tables

1	Ordering Information	7
2	Truth Table	8
3	Maximum Ratings	9
4	Operation Ranges	9
5	RF Input Power	9
6	RF Characteristics	10
7	Pin Description	12
8	Mechanical Data	12

BGS12S3N6 Wideband RF SPDT Switch in ultra small package with 0.64mm² footprint

1 Features

- 2 high-linearity TRx paths with power handling capability of up to 30 dBm
- High switching speed, ideal for WLAN and Bluetooth applications
- All ports fully bi-directional
- Low insertion loss
- Low harmonic generation
- High port-to-port-isolation
- 0.05 to 6 GHz coverage
- High ESD robustness
- On-chip control logic
- Very small leadless and halogen free package TSNP-6-6 (0.65x0.98 mm²) with super low height of 0.375 mm
- No decoupling capacitors required if no DC applied on RF lines
- RoHS compliant package

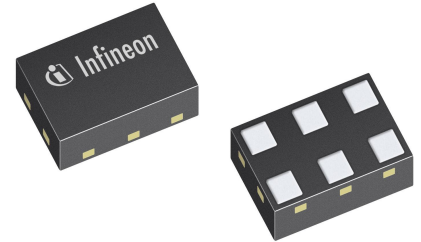

2 Product Description

The BGS12S3N6 RF MOS switch is specifically designed for WLAN and Bluetooth applications. Any of the 2 ports can be used as termination of the diversity antenna handling up to 30 dBm.

This single supply chip integrates on-chip CMOS logic driven by a simple, single-pin CMOS or TTL compatible control input signal. The 0.1 dB compression point exceeds the switch's maximum input power level, resulting in linear performance at all signal levels. The RF switch has a very low insertion loss of 0.25 dB in the 1 GHz and 0.29 dB in the 2.5 GHz range.

Unlike GaAs technology, external DC blocking capacitors at the RF ports are only required if DC voltage is applied externally.

The BGS12S3N6 RF switch is manufactured in Infineon's patented MOS technology, offering the performance of GaAs with the economy and integration of conventional CMOS including the inherent higher ESD robustness.

The device has a very small size of only 0.65x0.98mm² and a maximum height of 0.375 mm.

Table 1: Ordering Information

Type	Package	Marking
BGS12S3N6	TSNP-6-6	R

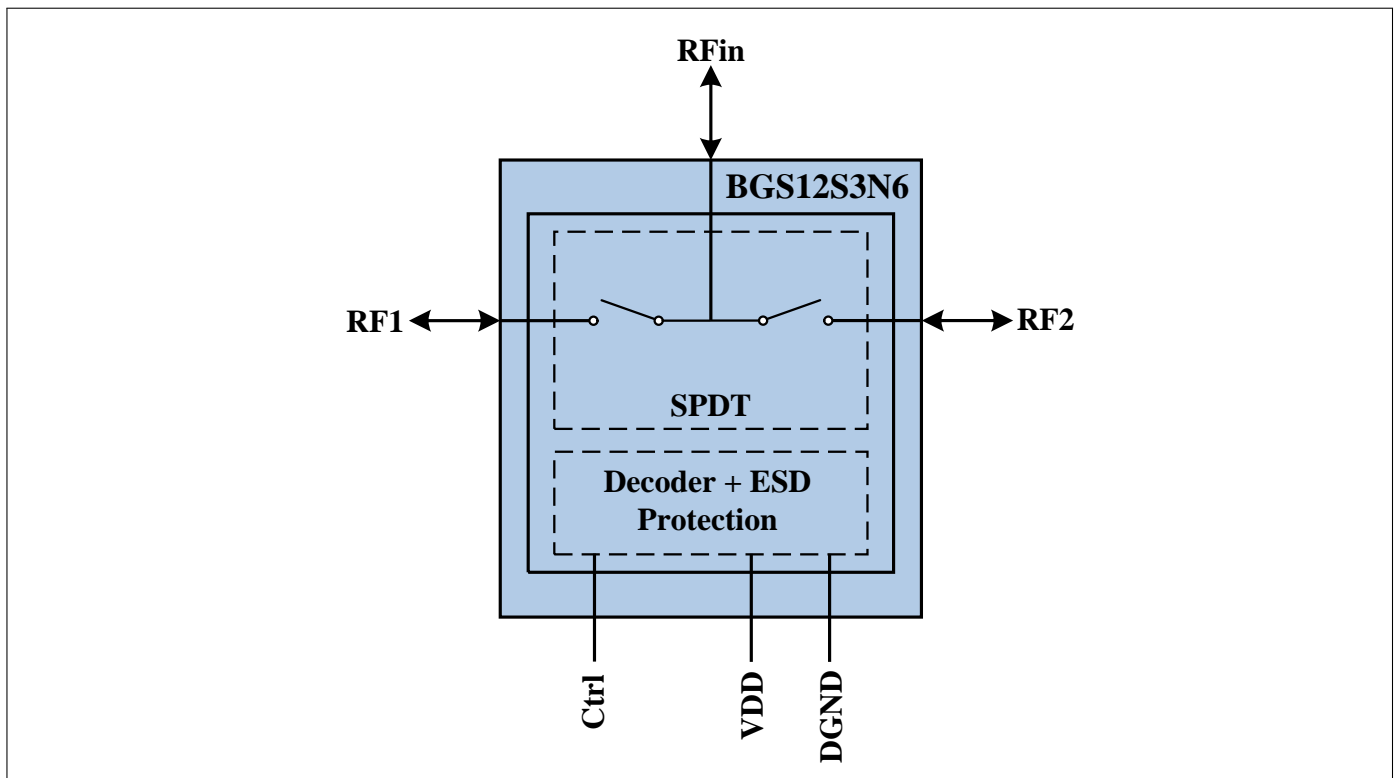

Figure 1: BGS12S3N6 Block Diagram

Table 2: Truth Table

Switched Paths	Ctrl
RFin - RF1	0
RFin - RF2	1

3 Maximum Ratings

Table 3: Maximum Ratings at $T_A = 25\text{ }^\circ\text{C}$, unless otherwise specified

Parameter	Symbol	Values			Unit	Note / Test Condition
		Min.	Typ.	Max.		
Supply Voltage	V_{dd}	-0.5	–	3.6	V	–
Maximum DC-Voltage on Other Pins	V_{DC}	0	–	0	V	No external DC voltage allowed
Storage Temperature Range	T_{STG}	-65	–	150	$^\circ\text{C}$	–
RF Input Power	P_{RF}	–	–	32	dBm	–
Junction Temperature	T_j	–	–	125	$^\circ\text{C}$	–
ESD Capability						
Human Body Model ¹⁾	V_{ESD_HBM}	–1000	–	+1000	V	–
ESD Capability RFin Port ²⁾	V_{ESD_RFin}	–8	–	+8	kV	RFin versus GND, with 27 nH shunt inductor

¹⁾ Human Body Model ANSI/ESDA/JEDEC JS-001-2012 ($R = 1.5\text{ k}\Omega$, $C = 100\text{ pF}$).

²⁾ IEC 61000-4-2 ($R = 330\text{ }\Omega$, $C = 150\text{ pF}$), contact discharge.

Attention:

Stresses above the max. values listed here may cause permanent damage to the device. Exposure to absolute maximum rating conditions for extended periods may affect device reliability. Maximum ratings are absolute ratings; exceeding only one of these values may cause irreversible damage to the integrated circuit.

4 Operation Ranges

Table 4: Operation Ranges

Parameter	Symbol	Values			Unit	Note / Test Condition
		Min.	Typ.	Max.		
Ambient Temperature	T_A	-40	25	85	$^\circ\text{C}$	–
RF Frequency	f	0.05	–	6	GHz	–
Supply Voltage	V_{dd}	1.8	–	3.5	V	–
Control Voltage Low	V_{Ctrl_L}	-0.3	–	0.43	V	–
Control Voltage High	V_{Ctrl_H}	1.35	–	V_{DD}	V	–

Table 5: RF Input Power

Parameter	Symbol	Values			Unit	Note / Test Condition
		Min.	Typ.	Max.		
RF Input Power (50 Ω)	P_{In}	–	–	30	dBm	–

5 RF Characteristics

Table 6: RF Characteristics

Test Conditions (unless otherwise specified):

- Terminating port impedance: $Z_0 = 50 \Omega$
- Temperature range: $T_A = -40 \dots +85 \text{ }^\circ\text{C}$
- Supply voltage: $V_{DD} = 1.8 \dots 3.4 \text{ V}$
- Input power: $P_{IN} = 0 \text{ dBm}$

Parameter	Symbol	Values			Unit	Note / Test Condition
		Min.	Typ.	Max.		
Insertion Loss						
All RF Ports	IL	–	0.25	0.43	dB	824-915 MHz
		–	0.33	0.45	dB	1710-1910 MHz
		–	0.35	0.50	dB	2170-2690 MHz
		–	0.53	0.78	dB	5000 MHz
		–	0.70	0.90	dB	6000 MHz
Insertion Loss¹						
All RF Ports	IL	–	0.25	0.35	dB	824-915 MHz
		–	0.33	0.40	dB	1710-1910 MHz
		–	0.35	0.45	dB	2170-2690 MHz
		–	0.53	0.70	dB	5000 MHz
		–	0.70	0.85	dB	6000 MHz
Return Loss						
All RF Ports	RL	22	30	–	dB	824-915 MHz
		20	25	–	dB	1710-1910 MHz
		17	20	–	dB	2170-2690 MHz
		12	18	–	dB	5000 MHz
		12	16	–	dB	6000 MHz
Isolation						
RF _{in} to RF1/RF2 Port	$ISO_{RF_{in}-RFx}$	35	40	–	dB	824-915 MHz
		28	32	–	dB	1710-1910 MHz
		26	28	–	dB	2170-2690 MHz
		15	19	–	dB	5000 MHz
		15	18	–	dB	6000 MHz
RF1 to RF2 Port / RF2 to RF1 Port	$ISO_{Port-Port}$	42	45	–	dB	824-915 MHz
		34	38	–	dB	1710-1910 MHz
		30	33	–	dB	2170-2690 MHz
		18	21	–	dB	5000 MHz
		18	21	–	dB	6000 MHz

¹ $T_A = +25 \text{ }^\circ\text{C}$, $V_{DD} = 2.6 \text{ V}$

Parameter	Symbol	Values			Unit	Note / Test Condition
		Min.	Typ.	Max.		
Harmonic Generation up to 12.75 GHz						
All RF Ports, 2 nd Harmonic	P_{Harm}	–	-80	-75	dBc	$V_{DD} = 2.85V, T_A = 25\text{ }^\circ\text{C},$ $f = 824\text{ MHz}, P_{in} = 27.5\text{ dBm},$ 50% duty cycle, 50 Ω
All RF Ports, 3 rd Harmonic		–	-95	-85	dBc	
Compression Point 0.1dB						
P0.1dB	$P_{0.1dB}$	–	–	-34	dBm	
Intermodulation Distortion in Rx Band						
IMD2	$IMD2$	–	-110	-100	dBm	Tx = 10 dBm, Interferer = -15 dBm, 50 Ω
IMD3	$IMD3$	–	-130	-120	dBm	
Switching Time and Current Consumption						
RF Rise Time	$t_{10\%-90\%}$	–	60	100	ns	10% - 90% of RF Signal
Ctrl to RF Time	$t_{Ctrl-RF}$	–	400	500	ns	50% of Ctrl Signal to 90% of RF Signal
Power Up Settling Time	t_{PUP}	–	5	15	μs	After power down
Supply Current	I_{dd}	–	100	180	μA	–
Control Current	I_{Ctrl}	–	1	10	μA	–

Note: All electrical characteristics are measured with all RF ports terminated by 50 Ω loads.

6 Pin Description

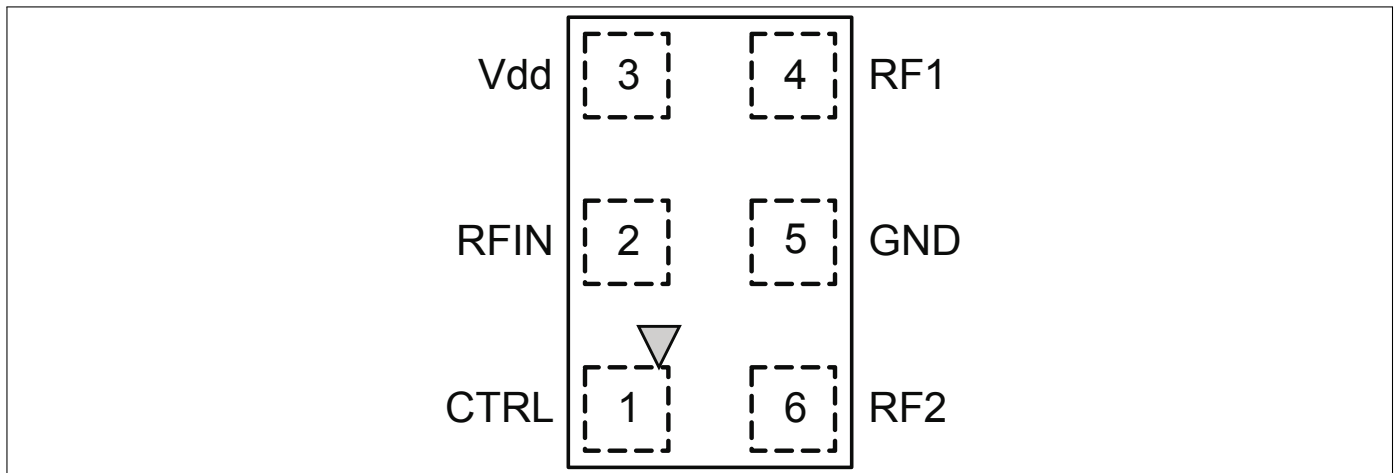

Figure 2: Pin Configuration

Table 7: Pin Description

Pin No.	Name	Pin Type	Buffer Type	Function
1	CTRL	I		Control Pin
2	RFIN	I/O		RF Port In
3	Vdd	PWR		Supply Voltage
4	RF1	I/O		RF Port 1
5	GND	GND		Ground
6	RF2	I/O		RF Port 2

7 Package Information

Table 8: Mechanical Data

Parameter	Symbol	Value	Unit
X-Dimension	<i>X</i>	0.65 ± 0.05	mm
Y-Dimension	<i>Y</i>	0.98 ± 0.05	mm
Size	<i>Size</i>	0.64	mm ²
Height	<i>H</i>	0.375 ± 0.025	mm

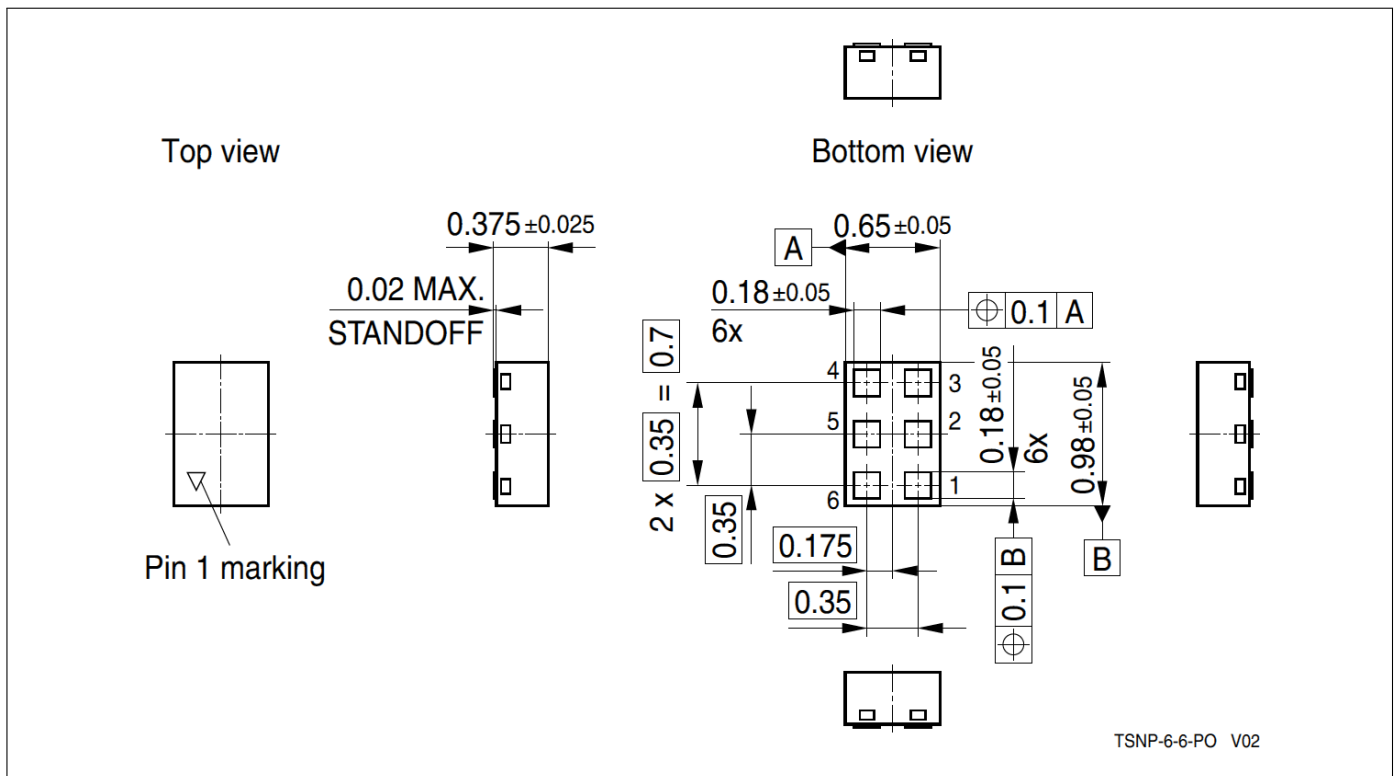

Figure 3: Package Outline

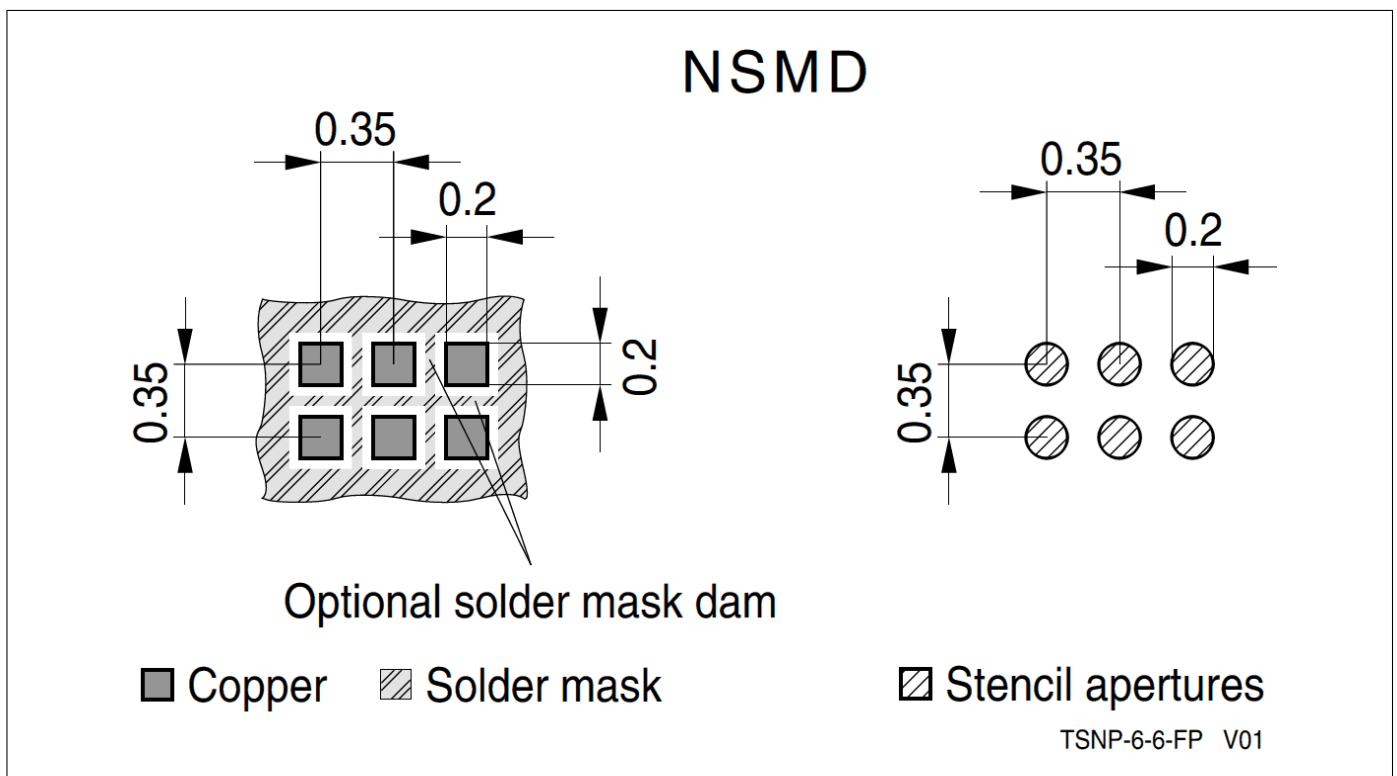

Figure 4: Footprint

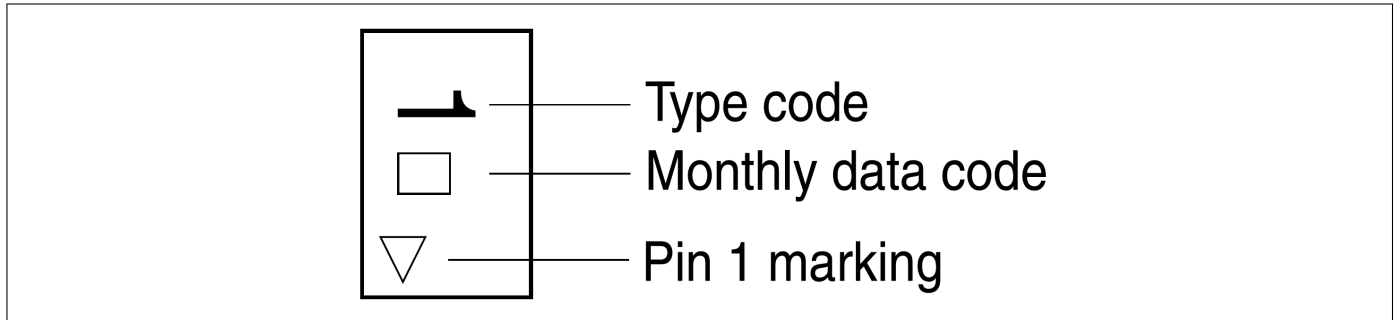

Figure 5: Pin 1 Marking (top view)

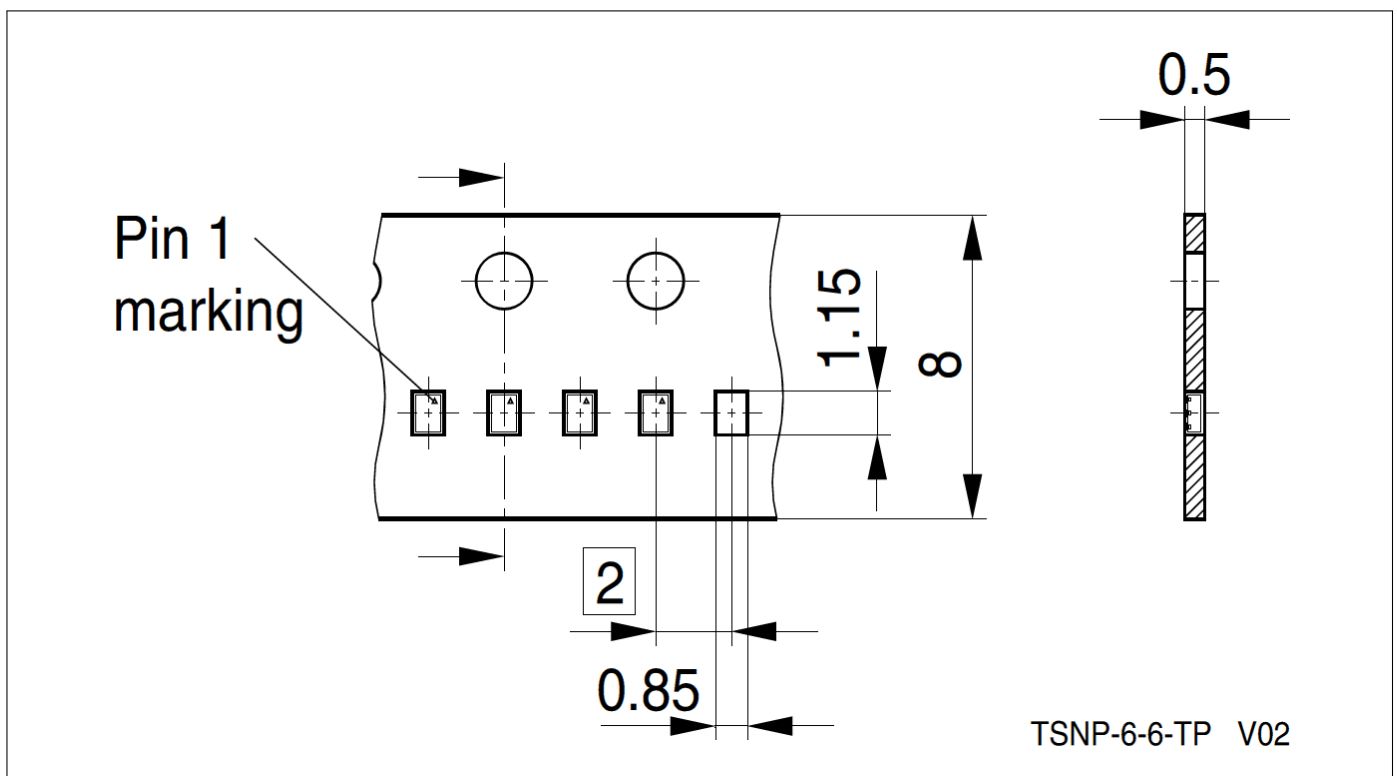

Figure 6: Tape Drawing for TSNP6-6

www.infineon.com

Published by Infineon Technologies AG

Компания «Life Electronics» занимается поставками электронных компонентов импортного и отечественного производства от производителей и со складов крупных дистрибьюторов Европы, Америки и Азии.

С конца 2013 года компания активно расширяет линейку поставок компонентов по направлению коаксиальный кабель, кварцевые генераторы и конденсаторы (керамические, пленочные, электролитические), за счёт заключения дистрибьюторских договоров

Мы предлагаем:

- Конкурентоспособные цены и скидки постоянным клиентам.
- Специальные условия для постоянных клиентов.
- Подбор аналогов.
- Поставку компонентов в любых объемах, удовлетворяющих вашим потребностям.
- Приемлемые сроки поставки, возможна ускоренная поставка.
- Доставку товара в любую точку России и стран СНГ.
- Комплексную поставку.
- Работу по проектам и поставку образцов.
- Формирование склада под заказчика.
- Сертификаты соответствия на поставляемую продукцию (по желанию клиента).
- Тестирование поставляемой продукции.
- Поставку компонентов, требующих военную и космическую приемку.
- Входной контроль качества.
- Наличие сертификата ISO.

В составе нашей компании организован Конструкторский отдел, призванный помогать разработчикам, и инженерам.

Конструкторский отдел помогает осуществить:

- Регистрацию проекта у производителя компонентов.
- Техническую поддержку проекта.
- Защиту от снятия компонента с производства.
- Оценку стоимости проекта по компонентам.
- Изготовление тестовой платы монтаж и пусконаладочные работы.



Тел: +7 (812) 336 43 04 (многоканальный)
Email: org@lifeelectronics.ru