

74HC4538

Dual retriggerable precision monostable multivibrator

Rev. 5 — 17 March 2017

Product data sheet

1 General description

The 74HC4538 is a dual retriggerable-resettable monostable multivibrator. Each multivibrator has two trigger/retrigger inputs ($n\bar{A}$ and nB), a direct reset input ($n\bar{CD}$), two complementary outputs (nQ and $n\bar{Q}$), and two pins ($nREXT/CEXT$ and $nCEXT$) for connecting the external timing components C_{EXT} and R_{EXT} . Typical pulse width variation over temperature range is $\pm 0.2\%$. The device may be triggered by either the positive or the negative edges of the input pulse. The duration and accuracy of the output pulse are determined by the external timing components C_{EXT} and R_{EXT} . The output pulse width (T_W) is equal to $0.7 \times R_{EXT} \times C_{EXT}$. The linear design techniques guarantee precise control of the output pulse width. A LOW level at $n\bar{CD}$ terminates the output pulse immediately. Schmitt-trigger action in the trigger inputs makes the circuit highly tolerant to slower rise and fall times. Inputs include clamp diodes. This enables the use of current limiting resistors to interface inputs to voltages in excess of V_{CC} .

2 Features and benefits

- Tolerant of slow trigger rise and fall times
- Separate reset inputs
- Triggering from falling or rising edge
- Complies with JEDEC standard no. 7A
- CMOS input levels:
- ESD protection:
 - HBM JESD22-A114F exceeds 2000 V
 - MM JESD22-A115-A exceeds 200 V
- Multiple package options
- Specified from $-40\text{ }^\circ\text{C}$ to $+85\text{ }^\circ\text{C}$ and from $-40\text{ }^\circ\text{C}$ to $+125\text{ }^\circ\text{C}$

3 Ordering information

Table 1. Ordering information

Type number	Package			Version
	Temperature range	Name	Description	
74HC4538D	-40 °C to +125 °C	SO16	plastic small outline package; 16 leads; body width 3.9 mm	SOT109-1
74HC4538DB	-40 °C to +125 °C	SSOP16	plastic shrink small outline package; 16 leads; body width 5.3 mm	SOT338-1
74HC4538PW	-40 °C to +125 °C	TSSOP16	plastic thin shrink small outline package; 16 leads; body width 4.4 mm	SOT403-1

4 Functional diagram

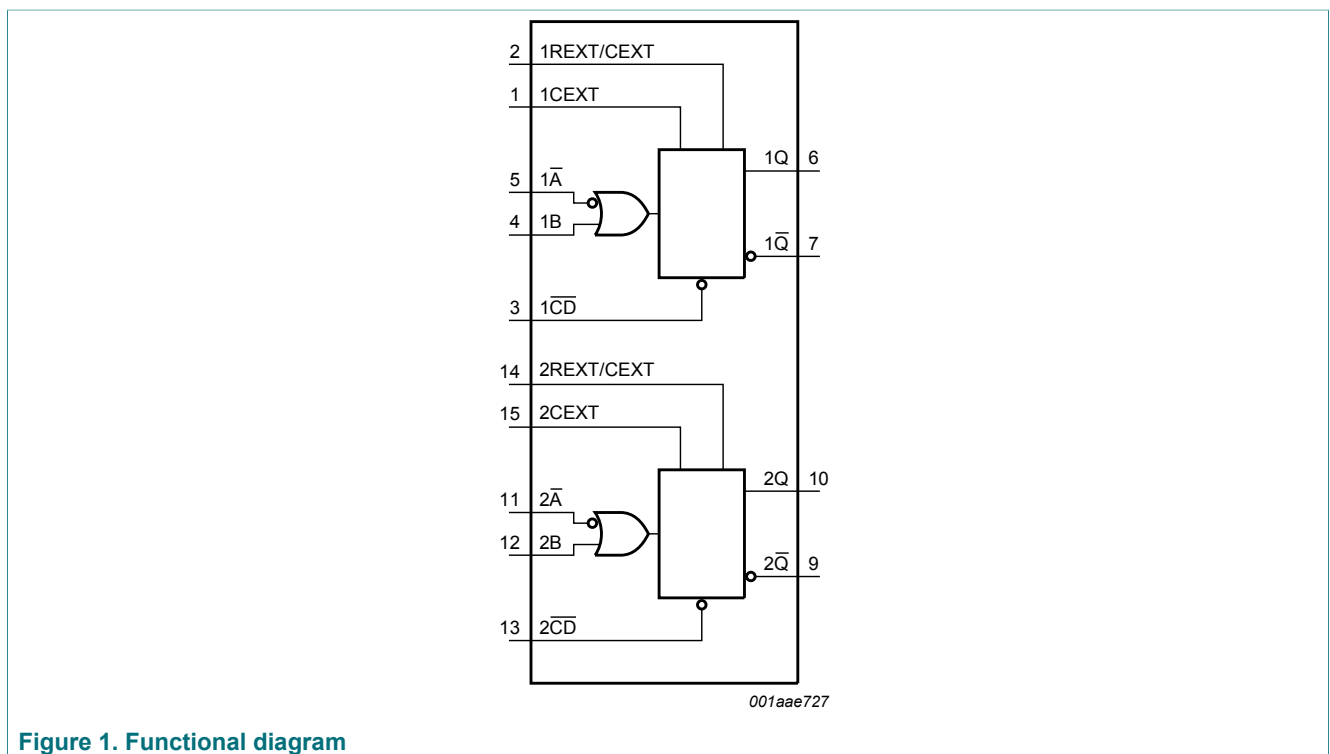



Figure 2. Logic diagram (one multivibrator)

5 Pinning information

5.1 Pinning



Figure 3. Pin configuration for SO16

Figure 4. Pin configuration for SSOP16 and TSSOP16

5.2 Pin description

Table 2. Pin description

Symbol	Pin	Description
1CEXT, 2CEXT	1, 15	external capacitor connection (always connected to ground)
1REXT/CEXT, 2REXT/CEXT	2, 14	external capacitor/resistor connection
1 \overline{CD} , 2 \overline{CD}	3, 13	direct reset input (active LOW)
1B, 2B	4, 12	input (LOW to HIGH triggered)
1 \overline{A} , 2 \overline{A}	5, 11	input (HIGH to LOW triggered)
1Q, 2Q	6, 10	output
1 \overline{Q} , 2 \overline{Q}	7, 9	complementary output (active LOW)
GND	8	ground (0 V)
V _{CC}	16	supply voltage

6 Functional description

Table 3. Function table ^[1]

Inputs			Outputs	
n \bar{A}	nB	n \bar{CD}	nQ	n \bar{Q}
↓	L	H		
H	↑	H		
X	X	L	L	H

- [1] H = HIGH voltage level; L = LOW voltage level; X = don't care;
 ↑ = positive-going transition; ↓ = negative-going transition;
 = one HIGH level output pulse, with the pulse width determined by C_{EXT} and R_{EXT};
 = one LOW level output pulse, with the pulse width determined by C_{EXT} and R_{EXT}.



- (1) Positive edge triggering.
 (2) Positive edge re-triggering (pulse lengthening).
 (3) Negative edge triggering.
 (4) Reset (pulse shortening).
 (5) $T_W = 0.7 \times R_{EXT} \times C_{EXT}$ (see also [Figure 6](#)).

Figure 5. Timing diagram

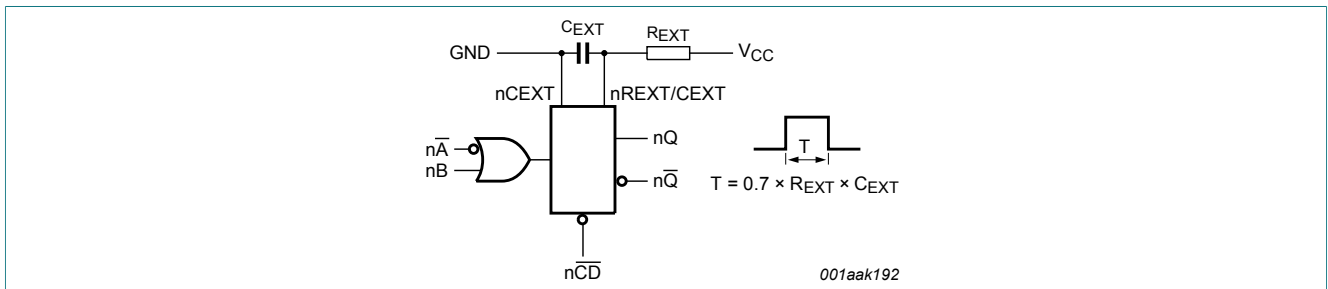

Figure 6. Connection of the external timing components R_{EXT} and C_{EXT}

7 Limiting values

Table 4. Limiting values

In accordance with the Absolute Maximum Rating System (IEC 60134). Voltages are referenced to GND (ground = 0 V).

Symbol	Parameter	Conditions	Min	Max	Unit
V_{CC}	supply voltage		-0.5	+7.0	V
I_{IK}	input clamping current	$V_I < -0.5\text{ V}$ or $V_I > V_{CC} + 0.5\text{ V}$ [1]	-	± 20	mA
I_{OK}	output clamping current	$V_O < -0.5\text{ V}$ or $V_O > V_{CC} + 0.5\text{ V}$ [1]	-	± 20	mA
I_O	output current	$V_O = -0.5\text{ V}$ to $V_{CC} + 0.5\text{ V}$	-	± 25	mA
I_{CC}	supply current		-	+50	mA
I_{GND}	ground current		-50	-	mA
T_{stg}	storage temperature		-65	+150	°C
P_{tot}	total power dissipation	$T_{amb} = -40\text{ °C}$ to $+125\text{ °C}$			
		SO16 package [2]	-	500	mW
		(T)SSOP16 package [3]	-	500	mW

[1] The input and output voltage ratings may be exceeded if the input and output current ratings are observed.

[2] P_{tot} derates linearly with 8 mW/K above 70 °C.

[3] P_{tot} derates linearly with 5.5 mW/K above 60 °C.

8 Recommended operating conditions

Table 5. Recommended operating conditions

Voltages are referenced to GND (ground = 0 V)

Symbol	Parameter	Conditions	Min	Typ	Max	Unit
V_{CC}	supply voltage		2.0	5.0	6.0	V
V_I	input voltage		0	-	V_{CC}	V
V_O	output voltage		0	-	V_{CC}	V
T_{amb}	ambient temperature		-40	-	+125	°C
$\Delta t/\Delta V$	input transition rise and fall rate	$V_{CC} = 2.0\text{ V}$	-	-	625	ns/V
		$V_{CC} = 4.5\text{ V}$	-	1.67	139	ns/V
		$V_{CC} = 6.0\text{ V}$	-	-	83	ns/V

9 Static characteristics

Table 6. Static characteristics

At recommended operating conditions; voltages are referenced to GND (ground = 0 V).

Symbol	Parameter	Conditions	25 °C			-40 °C to +85 °C		-40 °C to +125 °C		Unit
			Min	Typ	Max	Min	Max	Min	Max	
V _{IH}	HIGH-level input voltage	V _{CC} = 2.0 V	1.5	1.2	-	1.5	-	1.5	-	V
		V _{CC} = 4.5 V	3.15	2.4	-	3.15	-	3.15	-	V
		V _{CC} = 6.0 V	4.2	3.2	-	4.2	-	4.2	-	V
V _{IL}	LOW-level input voltage	V _{CC} = 2.0 V	-	0.8	0.5	-	0.5	-	0.5	V
		V _{CC} = 4.5 V	-	2.1	1.35	-	1.35	-	1.35	V
		V _{CC} = 6.0 V	-	2.8	1.8	-	1.8	-	1.8	V
V _{OH}	HIGH-level output voltage	V _I = V _{IH} or V _{IL}								
		I _O = -20 μA; V _{CC} = 2.0 V	1.9	2.0	-	1.9	-	1.9	-	V
		I _O = -20 μA; V _{CC} = 4.5 V	4.4	4.5	-	4.4	-	4.4	-	V
		I _O = -20 μA; V _{CC} = 6.0 V	5.9	6.0	-	5.9	-	5.9	-	V
		I _O = -4.0 mA; V _{CC} = 4.5 V	3.98	4.32	-	3.84	-	3.7	-	V
	I _O = -5.2 mA; V _{CC} = 6.0 V	5.48	5.81	-	5.34	-	5.2	-	V	
V _{OL}	LOW-level output voltage	V _I = V _{IH} or V _{IL}								
		I _O = 20 μA; V _{CC} = 2.0 V	-	0	0.1	-	0.1	-	0.1	V
		I _O = 20 μA; V _{CC} = 4.5 V	-	0	0.1	-	0.1	-	0.1	V
		I _O = 20 μA; V _{CC} = 6.0 V	-	0	0.1	-	0.1	-	0.1	V
		I _O = 4.0 mA; V _{CC} = 4.5 V	-	0.15	0.26	-	0.33	-	0.4	V
	I _O = 5.2 mA; V _{CC} = 6.0 V	-	0.16	0.26	-	0.33	-	0.4	V	
I _I	input leakage current	V _I = V _{CC} or GND; V _{CC} = 6.0 V	-	-	±0.1	-	±1	-	±1	μA
		pin nREXT/CEXT; V _I = 2.0 V or GND; other inputs at V _{CC} or GND; V _{CC} = 6.0 V ^[1]	-	-	±50	-	±500	-	±500	nA
I _{CC}	supply current	V _I = V _{CC} or GND; I _O = 0 A; V _{CC} = 6.0 V	-	-	8.0	-	80	-	160	μA
C _I	input capacitance		-	3.5	-	-	-	-	-	pF

[1] This measurement can only be carried out after a trigger pulse is applied.

10 Dynamic characteristics

Table 7. Dynamic characteristics

Voltages are referenced to GND (ground = 0 V); for test circuit see Figure 9.

Symbol	Parameter	Conditions	25 °C			-40 °C to +85 °C		-40 °C to +125 °C		Unit
			Min	Typ ^[1]	Max	Min	Max	Min	Max	
t _{PLH}	LOW to HIGH propagation delay	n \bar{A} , nB to nQ; see Figure 7								
		V _{CC} = 2.0 V	-	85	265	-	330	-	400	ns
		V _{CC} = 4.5 V	-	31	53	-	66	-	80	ns
		V _{CC} = 5.0 V; C _L = 15 pF	-	27	-	-	-	-	-	ns
		V _{CC} = 6.0 V	-	25	45	-	56	-	68	ns
		n $\bar{C}\bar{D}$ to n \bar{Q} ; see Figure 7								
		V _{CC} = 2.0 V	-	83	265	-	340	-	400	ns
		V _{CC} = 4.5 V	-	30	53	-	68	-	80	ns
t _{PHL}	HIGH to LOW propagation delay	n \bar{A} , nB to n \bar{Q} ; see Figure 7								
		V _{CC} = 2.0 V	-	83	265	-	330	-	400	ns
		V _{CC} = 4.5 V	-	30	53	-	66	-	80	ns
		V _{CC} = 5.0 V; C _L = 15 pF	-	27	-	-	-	-	-	ns
		V _{CC} = 6.0 V	-	24	45	-	56	-	68	ns
		n $\bar{C}\bar{D}$ to nQ; see Figure 7								
		V _{CC} = 2.0 V	-	80	265	-	330	-	400	ns
		V _{CC} = 4.5 V	-	29	53	-	66	-	80	ns
t _t	transition time	nQ and n \bar{Q} ; see Figure 7 ^[2]								
		V _{CC} = 2.0 V	-	19	75	-	95	-	119	ns
		V _{CC} = 4.5 V	-	7	15	-	19	-	22	ns
		V _{CC} = 6.0 V	-	6	13	-	16	-	19	ns
t _w	pulse width	n \bar{A} LOW; see Figure 8								
		V _{CC} = 2.0 V	80	17	-	100	-	120	-	ns
		V _{CC} = 4.5 V	16	6	-	20	-	24	-	ns
		V _{CC} = 6.0 V	14	5	-	17	-	20	-	ns
		nB HIGH; see Figure 8								
		V _{CC} = 2.0 V	80	17	-	100	-	120	-	ns
		V _{CC} = 4.5 V	16	6	-	20	-	24	-	ns
		V _{CC} = 6.0 V	14	5	-	17	-	20	-	ns
		n $\bar{C}\bar{D}$ LOW; see Figure 8								
		V _{CC} = 2.0 V	80	19	-	100	-	120	-	ns

Symbol	Parameter	Conditions	25 °C			-40 °C to +85 °C		-40 °C to +125 °C		Unit
			Min	Typ ^[1]	Max	Min	Max	Min	Max	
		V _{CC} = 4.5 V	16	7	-	20	-	24	-	ns
		V _{CC} = 6.0 V	14	6	-	17	-	20	-	ns
		nQ and nQ̄ HIGH or LOW; see Figure 8								
		V _{CC} = 5.0 V; C _{EXT} = 0.1 μF; R _{EXT} = 10 kΩ	630	700	770	602	798	595	805	μs
t _{rec}	recovery time	nCD to nA, nB; see Figure 8								
		V _{CC} = 2.0 V	35	6	-	45	-	55	-	ns
		V _{CC} = 4.5 V	7	2	-	9	-	11	-	ns
		V _{CC} = 6.0 V	6	2	-	8	-	9	-	ns
t _{trig}	retrigger time	nA, nB; see Figure 8 ; X = C _{EXT} / (4.5 × V _{CC})								
		V _{CC} = 2.0 V	-	455+X	-	-	-	-	-	ns
		V _{CC} = 4.5 V	-	80+X	-	-	-	-	-	ns
		V _{CC} = 6.0 V	-	55+X	-	-	-	-	-	ns
R _{EXT}	external timing resistor	V _{CC} = 2.0 V	10	-	1000	-	-	-	-	kΩ
		V _{CC} = 5.0 V	2	-	1000	-	-	-	-	kΩ
C _{EXT}	external timing capacitor		no limits							
C _{PD}	power dissipation capacitance	per multivibrator; V _I = GND to V _{CC}	^[3]	136	-	-	-	-	-	pF

[1] Typical values are measured at nominal supply voltage (V_{CC} = 3.3 V and V_{CC} = 5.0 V).

[2] t_r is the same as t_{THL} and t_{TLH}.

[3] C_{PD} is used to determine the dynamic power dissipation (P_D in μW).

$P_D = C_{PD} \times V_{CC}^2 \times f_i + \Sigma(C_L \times V_{CC}^2 \times f_o) + 0.48 \times C_{EXT} \times V_{CC}^2 \times f_o + D \times 0.8 \times V_{CC}$ where:

f_i = input frequency in MHz;

f_o = output frequency in MHz;

Σ(C_L × V_{CC}² × f_o) = sum of the outputs;

C_L = output load capacitance in pF;

V_{CC} = supply voltage in V;

D = duty cycle factor in %;

C_{EXT} = external timing capacitance in pF.

10.1 Waveforms and test circuit



001aak194

Measurement points are given in [Table 8](#).

Logic levels: V_{OL} and V_{OH} are typical output levels that occur with the output load.

Figure 7. Waveforms showing propagation delays and transition times

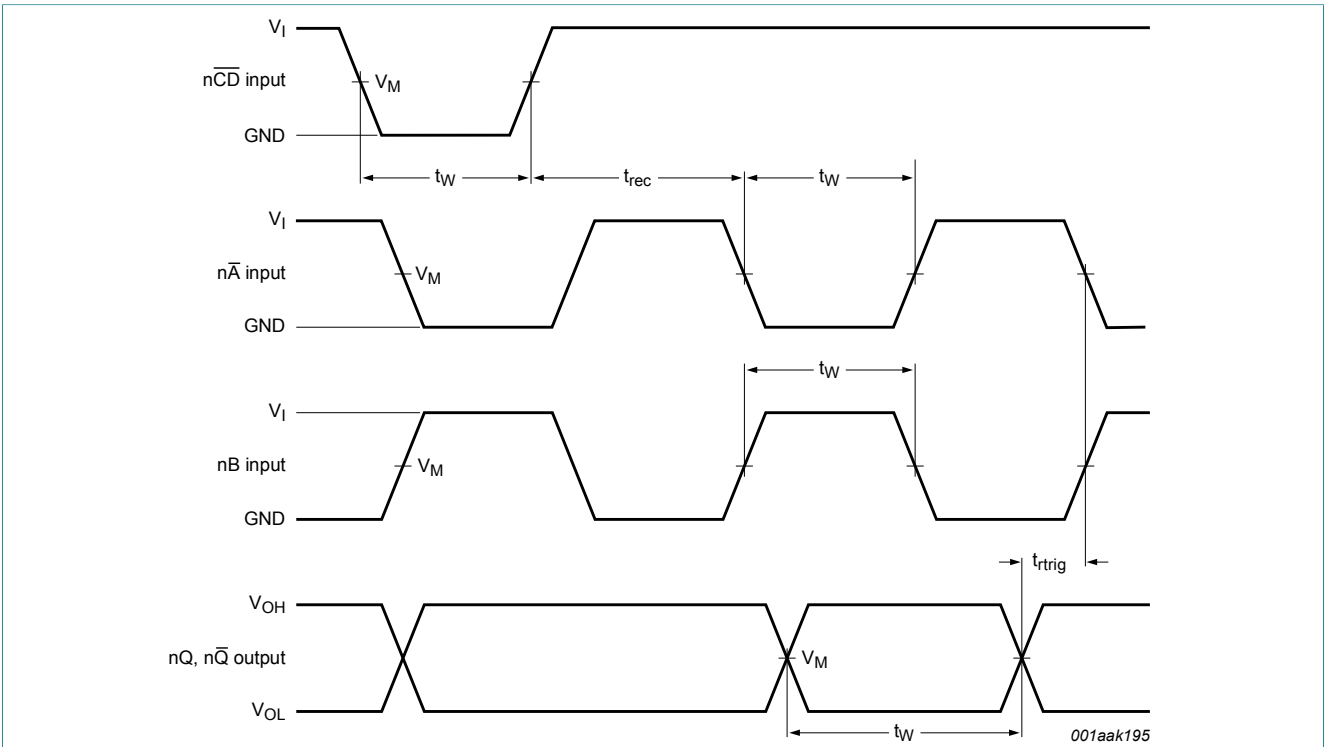

001aak195

Measurement points are given in [Table 8](#).

Logic levels: V_{OL} and V_{OH} are typical output levels that occur with the output load.

Figure 8. Waveforms showing nA, nB, nQ, nQ-bar pulse widths, recovery and retrigger times

Table 8. Measurement points

Input	Output		
V_M	V_M	V_X	V_Y
$0.5V_{CC}$	$0.5V_{CC}$	$0.1V_{CC}$	$0.9V_{CC}$



Test data is given in [Table 9](#).

Definitions test circuit:

R_T = Termination resistance should be equal to output impedance Z_o of the pulse generator.

C_L = Load capacitance including jig and probe capacitance.

R_L = Load resistance.

S1 = Test selection switch

Figure 9. Test circuit for measuring switching times

Table 9. Test data

Input		Load		S1 position
V_I	t_r, t_f	C_L	R_L	t_{PHL}, t_{PLH}
V_{CC}	6 ns	15 pF, 50 pF	1 kΩ	open

11 Application information

11.1 Power-down considerations

A large capacitor (C_{EXT}) may cause problems when powering-down the monostable due to energy stored in this capacitor. When a system containing this device is powered-down or rapid decrease of V_{CC} to zero occurs, the monostable may sustain damage, due to the capacitor discharging through the input protection diodes. To avoid this possibility, use a damping diode (D_{EXT}) preferably a germanium or Schottky type diode able to withstand large current surges and connect as shown in [Figure 10](#)

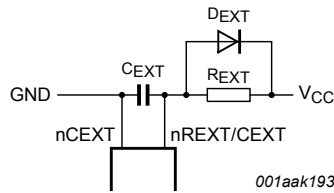
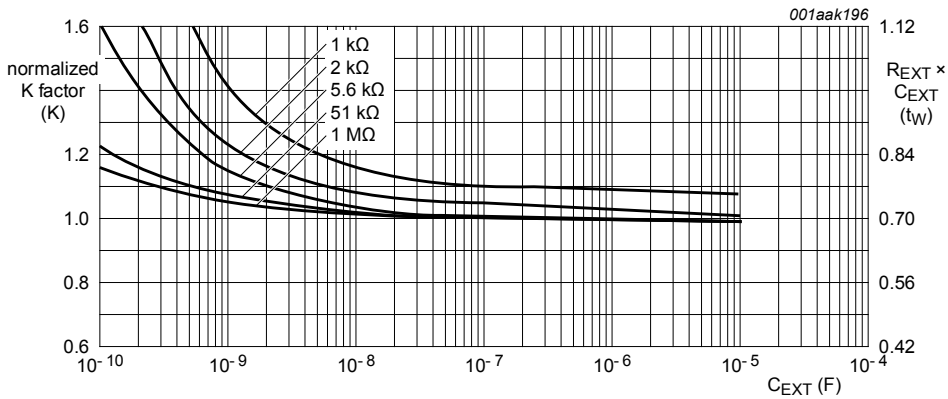

Figure 10. Power-down protection circuit

11.2 Graphs



$V_{CC} = 4.5 \text{ V}; T_{amb} = 25 \text{ }^\circ\text{C}.$

Figure 11. Typical pulse width accuracy versus external capacitance

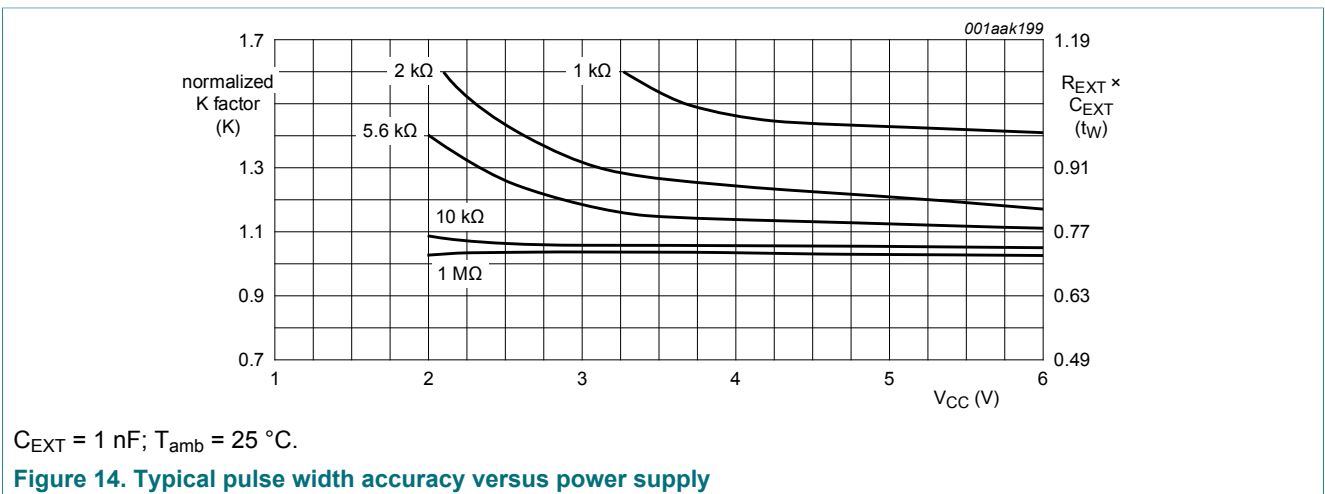
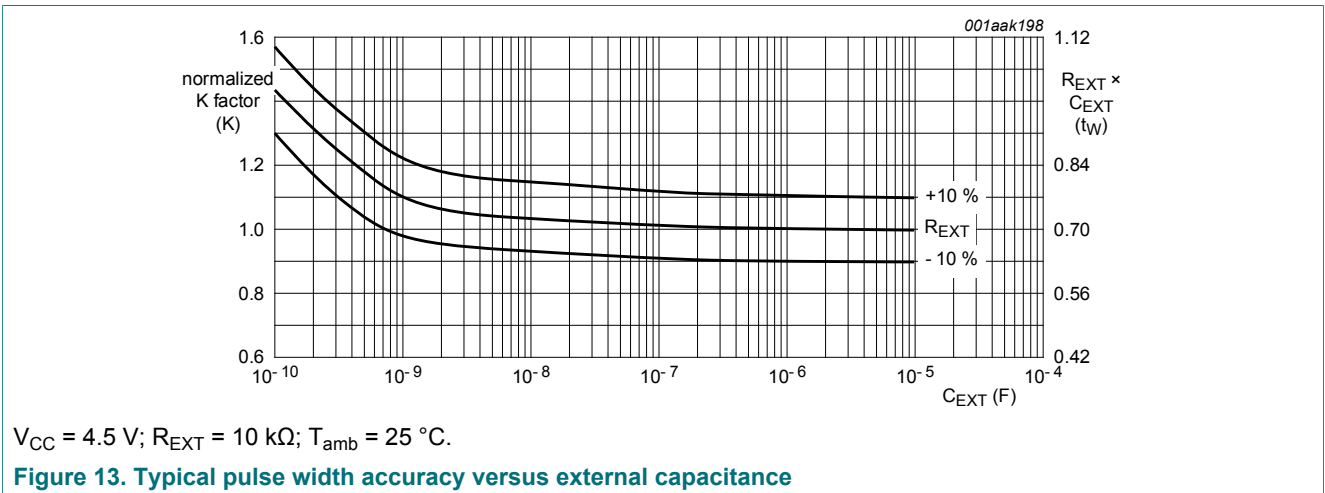
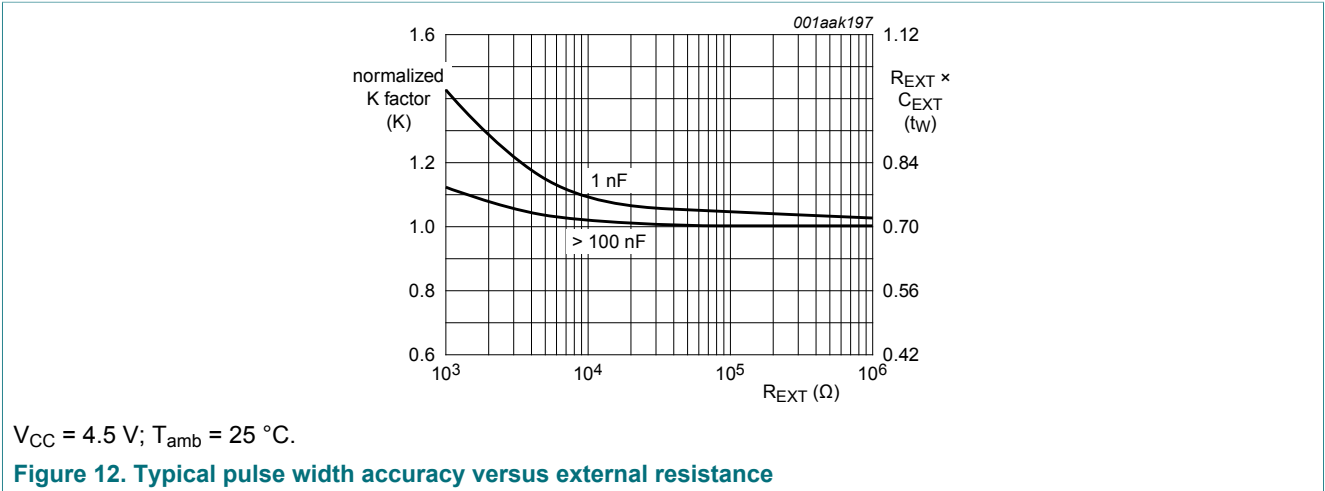



12 Package outline

SO16: plastic small outline package; 16 leads; body width 3.9 mm

SOT109-1



DIMENSIONS (inch dimensions are derived from the original mm dimensions)

UNIT	A max.	A ₁	A ₂	A ₃	b _p	c	D ⁽¹⁾	E ⁽¹⁾	e	H _E	L	L _p	Q	v	w	y	Z ⁽¹⁾	θ
mm	1.75	0.25 0.10	1.45 1.25	0.25	0.49 0.36	0.25 0.19	10.0 9.8	4.0 3.8	1.27	6.2 5.8	1.05	1.0 0.4	0.7 0.6	0.25	0.25	0.1	0.7 0.3	8° 0°
inches	0.069	0.010 0.004	0.057 0.049	0.01	0.019 0.014	0.0100 0.0075	0.39 0.38	0.16 0.15	0.05	0.244 0.228	0.041	0.039 0.016	0.028 0.020	0.01	0.01	0.004	0.028 0.012	

Note

1. Plastic or metal protrusions of 0.15 mm (0.006 inch) maximum per side are not included.

OUTLINE VERSION	REFERENCES			EUROPEAN PROJECTION	ISSUE DATE
	IEC	JEDEC	JEITA		
SOT109-1	076E07	MS-012			99-12-27 03-02-19

Figure 18. Package outline SOT109-1 (SO16)

SSOP16: plastic shrink small outline package; 16 leads; body width 5.3 mm

SOT338-1



DIMENSIONS (mm are the original dimensions)

UNIT	A _{max.}	A ₁	A ₂	A ₃	b _p	c	D ⁽¹⁾	E ⁽¹⁾	e	H _E	L	L _p	Q	v	w	y	Z ⁽¹⁾	θ
mm	2	0.21 0.05	1.80 1.65	0.25	0.38 0.25	0.20 0.09	6.4 6.0	5.4 5.2	0.65	7.9 7.6	1.25	1.03 0.63	0.9 0.7	0.2	0.13	0.1	1.00 0.55	8° 0°

Note

1. Plastic or metal protrusions of 0.25 mm maximum per side are not included.

OUTLINE VERSION	REFERENCES				EUROPEAN PROJECTION	ISSUE DATE
	IEC	JEDEC	JEITA			
SOT338-1		MO-150				99-12-27 03-02-19

Figure 19. Package outline SOT338-1 (SSOP16)

TSSOP16: plastic thin shrink small outline package; 16 leads; body width 4.4 mm

SOT403-1

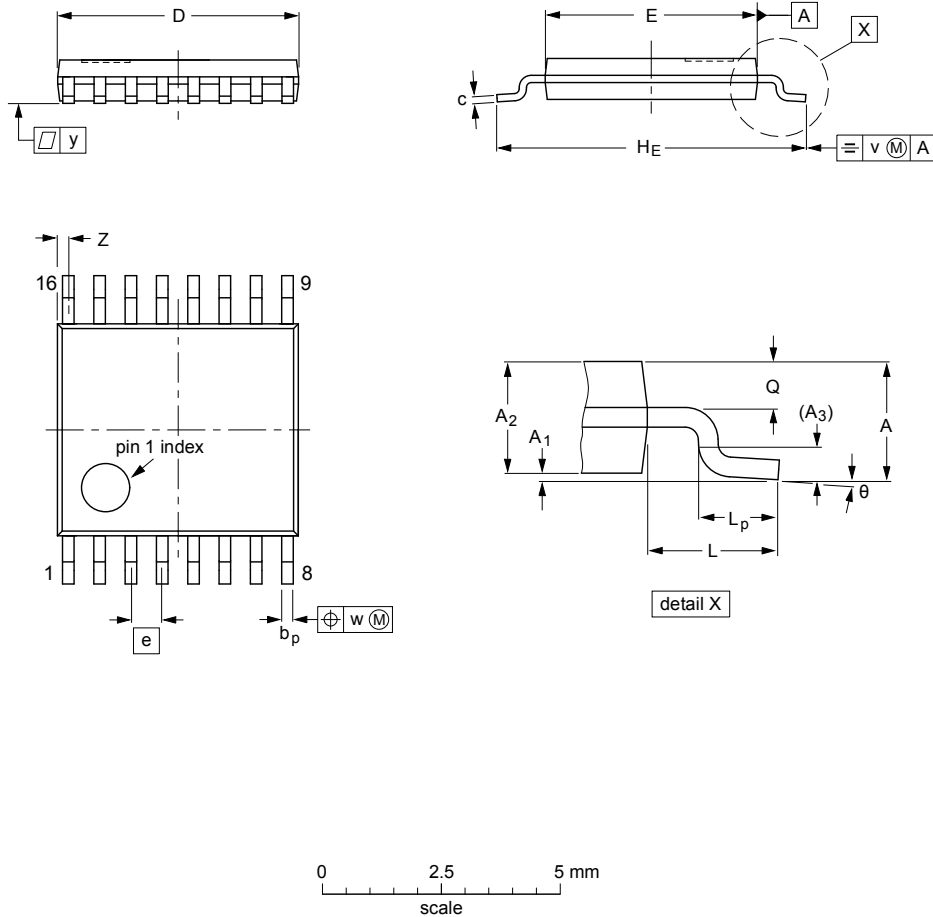

DIMENSIONS (mm are the original dimensions)

UNIT	A max.	A ₁	A ₂	A ₃	b _p	c	D ⁽¹⁾	E ⁽²⁾	e	H _E	L	L _p	Q	v	w	y	Z ⁽¹⁾	θ
mm	1.1	0.15 0.05	0.95 0.80	0.25	0.30 0.19	0.2 0.1	5.1 4.9	4.5 4.3	0.65	6.6 6.2	1	0.75 0.50	0.4 0.3	0.2	0.13	0.1	0.40 0.06	8° 0°

Notes

1. Plastic or metal protrusions of 0.15 mm maximum per side are not included.
2. Plastic interlead protrusions of 0.25 mm maximum per side are not included.

OUTLINE VERSION	REFERENCES				EUROPEAN PROJECTION	ISSUE DATE
	IEC	JEDEC	JEITA			
SOT403-1		MO-153				99-12-27 03-02-18

Figure 20. Package outline SOT403-1 (TSSOP16)

13 Abbreviations

Table 10. Abbreviations

Acronym	Description
CMOS	Complementary Metal-Oxide Semiconductor
DUT	Device Under Test
ESD	ElectroStatic Discharge
HBM	Human Body Model
MM	Machine Model

14 Revision history

Table 11. Revision history

Document ID	Release date	Data sheet status	Change notice	Supersedes
74HC4538 v.5	20170317	Product data sheet	-	74HC_HCT4538 v.4
Modifications:	<ul style="list-style-type: none"> Type numbers 74HCT4538D, 74HCT4538DB, 74HCT4538PW removed. Table 6: Maximum input leakage current for pins 1REXT/CEXT and 2REXT/CEXT changed. 			
74HC_HCT4538 v.4	20160224	Product data sheet	-	74HC_HCT4538 v.3
Modifications:	<ul style="list-style-type: none"> Type numbers 74HC4538N and 74HCT4538N (SOT38-4) removed. 			
74HC_HCT4538 v.3	20090608	Product data sheet	-	74HC_HCT4538_CNV v.2
Modifications:	<ul style="list-style-type: none"> The format of this data sheet has been redesigned to comply with the new identity guidelines of NXP Semiconductors. Legal texts have been adapted to the new company name where appropriate. Pin names changed throughout. Section Section 7, Section 8 and Section 9 added, taken from the 74HC/T HCMOS Family characteristics/specification (March 1988). Test circuit added: Figure 9. Quick reference data incorporated in to Section 9 and Section 10. Package information added for DIP16, SO16, SSOP16 and TSSOP16 packages. 			
74HC_HCT4538_CNV v.2	19970902	Product specification	-	-

15 Legal information

15.1 Data sheet status

Document status ^{[1][2]}	Product status ^[3]	Definition
Objective [short] data sheet	Development	This document contains data from the objective specification for product development.
Preliminary [short] data sheet	Qualification	This document contains data from the preliminary specification.
Product [short] data sheet	Production	This document contains the product specification.

[1] Please consult the most recently issued document before initiating or completing a design.

[2] The term 'short data sheet' is explained in section "Definitions".

[3] The product status of device(s) described in this document may have changed since this document was published and may differ in case of multiple devices. The latest product status information is available on the Internet at URL <http://www.nexperia.com>.

15.2 Definitions

Draft — The document is a draft version only. The content is still under internal review and subject to formal approval, which may result in modifications or additions. Nexperia does not give any representations or warranties as to the accuracy or completeness of information included herein and shall have no liability for the consequences of use of such information.

Short data sheet — A short data sheet is an extract from a full data sheet with the same product type number(s) and title. A short data sheet is intended for quick reference only and should not be relied upon to contain detailed and full information. For detailed and full information see the relevant full data sheet, which is available on request via the local Nexperia sales office. In case of any inconsistency or conflict with the short data sheet, the full data sheet shall prevail.

Product specification — The information and data provided in a Product data sheet shall define the specification of the product as agreed between Nexperia and its customer, unless Nexperia and customer have explicitly agreed otherwise in writing. In no event however, shall an agreement be valid in which the Nexperia product is deemed to offer functions and qualities beyond those described in the Product data sheet.

15.3 Disclaimers

Limited warranty and liability — Information in this document is believed to be accurate and reliable. However, Nexperia does not give any representations or warranties, expressed or implied, as to the accuracy or completeness of such information and shall have no liability for the consequences of use of such information. Nexperia takes no responsibility for the content in this document if provided by an information source outside of Nexperia. In no event shall Nexperia be liable for any indirect, incidental, punitive, special or consequential damages (including - without limitation - lost profits, lost savings, business interruption, costs related to the removal or replacement of any products or rework charges) whether or not such damages are based on tort (including negligence), warranty, breach of contract or any other legal theory. Notwithstanding any damages that customer might incur for any reason whatsoever, Nexperia's aggregate and cumulative liability towards customer for the products described herein shall be limited in accordance with the Terms and conditions of commercial sale of Nexperia.

Right to make changes — Nexperia reserves the right to make changes to information published in this document, including without limitation specifications and product descriptions, at any time and without notice. This document supersedes and replaces all information supplied prior to the publication hereof.

Suitability for use — Nexperia products are not designed, authorized or warranted to be suitable for use in life support, life-critical or safety-critical

systems or equipment, nor in applications where failure or malfunction of an Nexperia product can reasonably be expected to result in personal injury, death or severe property or environmental damage. Nexperia and its suppliers accept no liability for inclusion and/or use of Nexperia products in such equipment or applications and therefore such inclusion and/or use is at the customer's own risk.

Applications — Applications that are described herein for any of these products are for illustrative purposes only. Nexperia makes no representation or warranty that such applications will be suitable for the specified use without further testing or modification. Customers are responsible for the design and operation of their applications and products using Nexperia products, and Nexperia accepts no liability for any assistance with applications or customer product design. It is customer's sole responsibility to determine whether the Nexperia product is suitable and fit for the customer's applications and products planned, as well as for the planned application and use of customer's third party customer(s). Customers should provide appropriate design and operating safeguards to minimize the risks associated with their applications and products. Nexperia does not accept any liability related to any default, damage, costs or problem which is based on any weakness or default in the customer's applications or products, or the application or use by customer's third party customer(s). Customer is responsible for doing all necessary testing for the customer's applications and products using Nexperia products in order to avoid a default of the applications and the products or of the application or use by customer's third party customer(s). Nexperia does not accept any liability in this respect.

Limiting values — Stress above one or more limiting values (as defined in the Absolute Maximum Ratings System of IEC 60134) will cause permanent damage to the device. Limiting values are stress ratings only and (proper) operation of the device at these or any other conditions above those given in the Recommended operating conditions section (if present) or the Characteristics sections of this document is not warranted. Constant or repeated exposure to limiting values will permanently and irreversibly affect the quality and reliability of the device.

Terms and conditions of commercial sale — Nexperia products are sold subject to the general terms and conditions of commercial sale, as published at <http://www.nexperia.com/profile/terms>, unless otherwise agreed in a valid written individual agreement. In case an individual agreement is concluded only the terms and conditions of the respective agreement shall apply. Nexperia hereby expressly objects to applying the customer's general terms and conditions with regard to the purchase of Nexperia products by customer.

No offer to sell or license — Nothing in this document may be interpreted or construed as an offer to sell products that is open for acceptance or the grant, conveyance or implication of any license under any copyrights, patents or other industrial or intellectual property rights.

Export control — This document as well as the item(s) described herein may be subject to export control regulations. Export might require a prior authorization from competent authorities.

Non-automotive qualified products — Unless this data sheet expressly states that this specific Nexperia product is automotive qualified, the product is not suitable for automotive use. It is neither qualified nor tested in accordance with automotive testing or application requirements. Nexperia accepts no liability for inclusion and/or use of non-automotive qualified products in automotive equipment or applications. In the event that customer uses the product for design-in and use in automotive applications to automotive specifications and standards, customer (a) shall use the product without Nexperia's warranty of the product for such automotive applications, use and specifications, and (b) whenever customer uses the product for automotive applications beyond Nexperia's specifications such use shall be solely at customer's own risk, and (c) customer fully indemnifies Nexperia for any liability, damages or failed product claims resulting from customer

design and use of the product for automotive applications beyond Nexperia's standard warranty and Nexperia's product specifications.

Translations — A non-English (translated) version of a document is for reference only. The English version shall prevail in case of any discrepancy between the translated and English versions.

15.4 Trademarks

Notice: All referenced brands, product names, service names and trademarks are the property of their respective owners.

Contents

1	General description	1
2	Features and benefits	1
3	Ordering information	2
4	Functional diagram	2
5	Pinning information	4
5.1	Pinning	4
5.2	Pin description	4
6	Functional description	5
7	Limiting values	6
8	Recommended operating conditions	6
9	Static characteristics	7
10	Dynamic characteristics	8
10.1	Waveforms and test circuit	10
11	Application information	12
11.1	Power-down considerations	12
11.2	Graphs	12
12	Package outline	15
13	Abbreviations	18
14	Revision history	18
15	Legal information	19

Please be aware that important notices concerning this document and the product(s) described herein, have been included in section 'Legal information'.

© Nexperia B.V. 2017.

All rights reserved.

For more information, please visit: <http://www.nexperia.com>

For sales office addresses, please send an email to: salesaddresses@nexperia.com

Date of release: 17 March 2017
Document identifier: 74HC4538

Компания «Life Electronics» занимается поставками электронных компонентов импортного и отечественного производства от производителей и со складов крупных дистрибьюторов Европы, Америки и Азии.

С конца 2013 года компания активно расширяет линейку поставок компонентов по направлению коаксиальный кабель, кварцевые генераторы и конденсаторы (керамические, пленочные, электролитические), за счёт заключения дистрибьюторских договоров

Мы предлагаем:

- Конкурентоспособные цены и скидки постоянным клиентам.
- Специальные условия для постоянных клиентов.
- Подбор аналогов.
- Поставку компонентов в любых объемах, удовлетворяющих вашим потребностям.
- Приемлемые сроки поставки, возможна ускоренная поставка.
- Доставку товара в любую точку России и стран СНГ.
- Комплексную поставку.
- Работу по проектам и поставку образцов.
- Формирование склада под заказчика.
- Сертификаты соответствия на поставляемую продукцию (по желанию клиента).
- Тестирование поставляемой продукции.
- Поставку компонентов, требующих военную и космическую приемку.
- Входной контроль качества.
- Наличие сертификата ISO.

В составе нашей компании организован Конструкторский отдел, призванный помогать разработчикам, и инженерам.

Конструкторский отдел помогает осуществить:

- Регистрацию проекта у производителя компонентов.
- Техническую поддержку проекта.
- Защиту от снятия компонента с производства.
- Оценку стоимости проекта по компонентам.
- Изготовление тестовой платы монтаж и пусконаладочные работы.



Тел: +7 (812) 336 43 04 (многоканальный)
Email: org@lifeelectronics.ru