

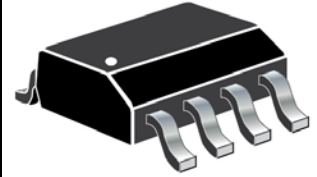

Unidirectional Low Capacitance TVSarray

DESCRIPTION

This USB50803 – USB50824 family of Transient Voltage Suppressor (TVS) arrays is packaged in an SO-8 configuration giving protection to 2 unidirectional data or interface lines. It is designed for use in applications where very low capacitance protection is required at the board level from voltage transients caused by electrostatic discharge (ESD) as defined in IEC 61000-4-2, electrical fast transients (EFT) per IEC 61000-4-4 and secondary effects of lightning. Using the [schematic](#) on the last page, pins 7 & 8 are tied together for the first protected positive line, and pins 1 & 2 are tied together to the ground. The same would then occur where pins 5 & 6 are tied together for a second protected positive line and pins 2 & 3 are tied together to the ground. If protecting a negative line with respect to ground, these may be switched in polarity connections where the pins are tied together in this manner for unidirectional protection. These TVS arrays have a peak power rating of 500 watts for an 8/20 μ sec pulse. This array is suitable for protection of sensitive circuitry such as TTL, CMOS DRAM's, SRAM's, HCMOS, HSIC microprocessors, Universal Serial Bus (USB) and I/O transceivers.



SO-8 Package

Also available:

Bidirectional version
(with opposite polarity in each leg)

 [USB50803C\(-A\) – USB50824C\(-A\)](#)

Important: For the latest information, visit our website <http://www.microsemi.com>.

FEATURES

- Provides electrically isolated protection for up to 2 unidirectional lines.
- Surge protection per IEC 61000-4-2 and IEC 61000-4-4.
- UL 94V-0 flammability classification.
- Ultra low capacitance; 3 pF per line pair.
- Ultra low leakage current.
- RoHS compliant versions available.

APPLICATIONS / BENEFITS

- EIA-RS485 data rates: 5 Mbs
- 10 Base T Ethernet.
- USB data rate: 900 Mbs

MAXIMUM RATINGS

Parameters/Test Conditions	Symbol	Value	Unit
Junction and Storage Temperature	T_J and T_{STG}	-55 to +150	$^{\circ}C$
Peak Pulse Power @ 8/20 μ s (see figure 1)	P_{PP}	500	W
Impulse Repetition Rate	df	< .01	%
Capacitance (f = 1 MHz) @ 0 V	C	3	pF
Solder Temperature @ 10 s	T_{SP}	260	$^{\circ}C$

MSC – Lawrence

6 Lake Street,
Lawrence, MA 01841
Tel: 1-800-446-1158 or
(978) 620-2600
Fax: (978) 689-0803

MSC – Ireland

Gort Road Business Park,
Ennis, Co. Clare, Ireland
Tel: +353 (0) 65 6840044
Fax: +353 (0) 65 6822298

Website:

www.microsemi.com

MECHANICAL and PACKAGING

- CASE: Molded SO-8 surface mount.
- TERMINALS: Tin-lead or RoHS compliant annealed matte-tin plating.
- MARKING: Logo, device marking code (see electrical characteristics table), date code.
- POLARITY: Pin #1 marked by dot on top of package.
- TAPE & REEL option: Per EIA standard 481. Consult factory for quantities. Carrier tubes with a quantity of 95 pieces are standard.
- WEIGHT: 0.066 grams (approximate).
- See [Package Dimensions](#) on last page.

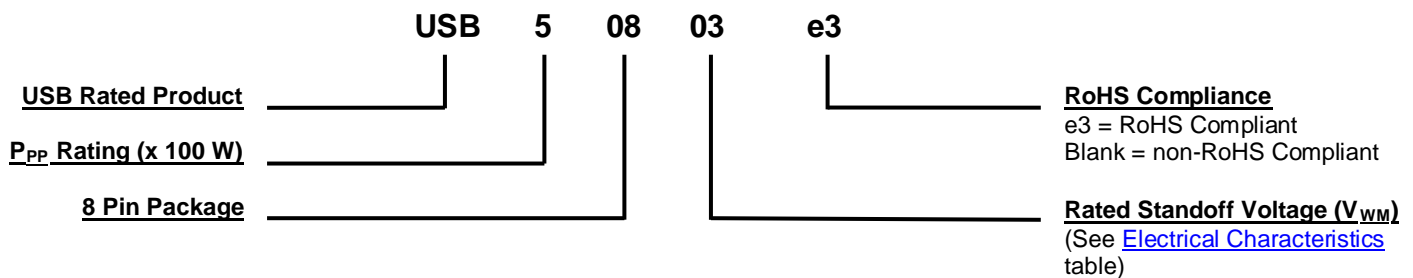
PART NOMENCLATURE

SYMBOLS & DEFINITIONS

Symbol	Definition
V _{WM}	Stand Off Voltage: Maximum dc voltage that can be applied over the operating temperature range. V _{WM} must be selected to be equal or be greater than the operating voltage of the line to be protected.
V _(BR)	Minimum Breakdown Voltage: The minimum voltage the device will exhibit at a specified current.
V _C	Clamping Voltage: Maximum clamping voltage across the TVS device when subjected to a given current at a pulse time of 20 μs.
I _D	Standby Current: Leakage current at V _{WM} .
C	Capacitance: Capacitance of the TVS as defined @ 0 volts at a frequency of 1 MHz and stated in picofarads.

ELECTRICAL CHARACTERISTICS

PART NUMBER	DEVICE MARKING*	STAND-OFF VOLTAGE V _{WM}	BREAKDOWN VOLTAGE V _(BR) @1 mA	CLAMPING VOLTAGE V _C @ 1 Amp (Figure 2)	CLAMPING VOLTAGE V _C @ 5 Amp (Figure 2)	STANDBY CURRENT I _D @ V _{WM}	CAPACITANCE (f = 1 MHz) C @ 0 V	TEMPERATURE COEFFICIENT OF V _(BR) α _{VBR}
		Volts	Volts	Volts	Volts	μA	pF	mV/°C
		MAX	MIN	MAX	MAX	MAX	MAX	MAX
USB50803	AF	3.3	4	8	11	200	3	-5
USB50805	AG	5.0	6.0	10.8	13	20	3	1
USB50812	AH	12.0	13.3	19	26	1	3	8
USB50815	AJ	15.0	16.7	24	32	1	3	11
USB50824	AK	24.0	26.7	43	57	1	3	28

* Device marking has an e3 suffix added for the RoHS compliant option, e.g. AF_{e3}, AG_{e3}, AH_{e3}, AJ_{e3}, and AK_{e3}.

NOTE: Transient Voltage Suppressor (TVS) products are normally selected based on their standoff voltage V_{WM}. The selected voltage should be equal to or greater than the peak operating voltage of the circuit to be protected.

GRAPHS

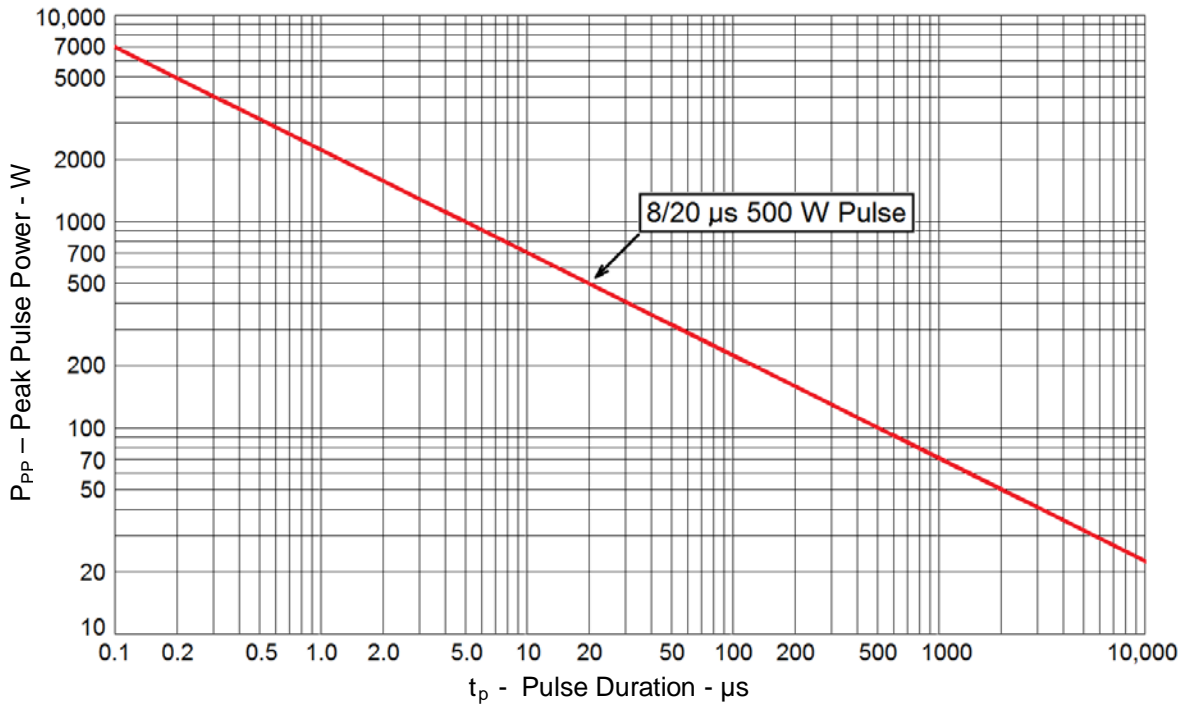

FIGURE 1
Peak Pulse Power vs Pulse Time

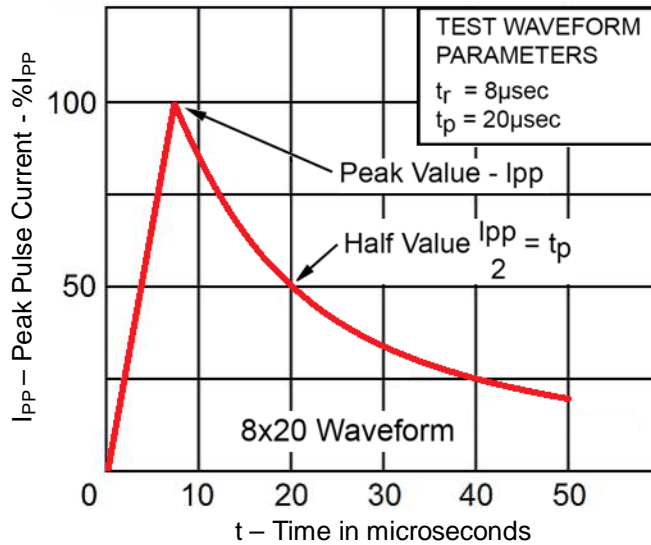
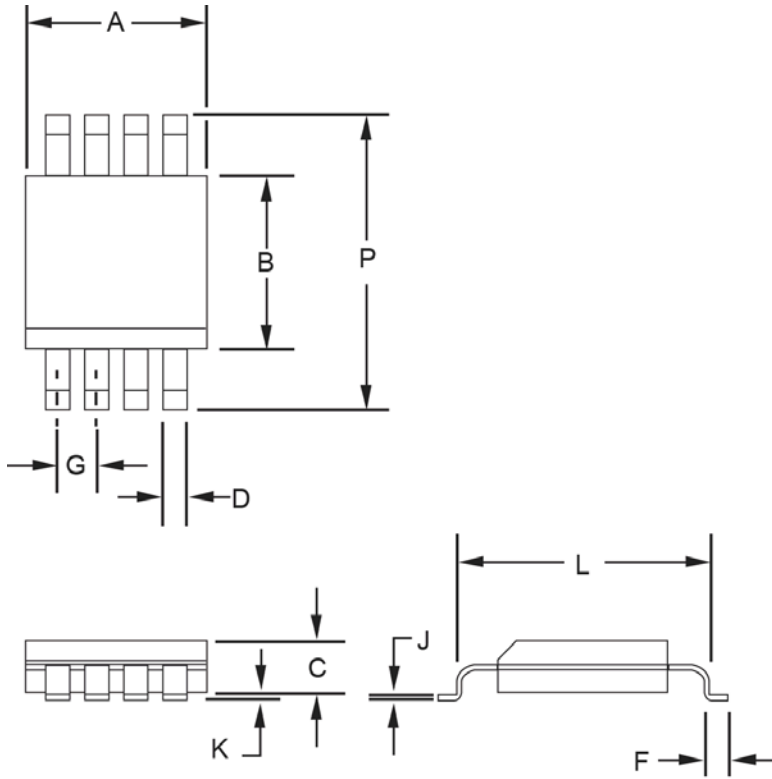

FIGURE 2
Pulse Waveform

PACKAGE DIMENSIONS



Ltr	Dimensions			
	Inch		Millimeters	
	Min	Max	Min	Max
A	0.188	0.197	4.77	5.00
B	0.150	0.158	3.81	4.01
C	0.053	0.069	1.35	1.75
D	0.011	0.021	0.28	0.53
F	0.0160	0.050	0.041	1.27
G	0.050 BSC		1.27 BSC	
J	0.006	0.010	0.15	0.25
K	0.004	0.008	0.10	0.20
L	0.189	0.206	4.80	5.23
P	0.228	0.244	5.79	6.19

PAD LAYOUT / SCHEMATIC

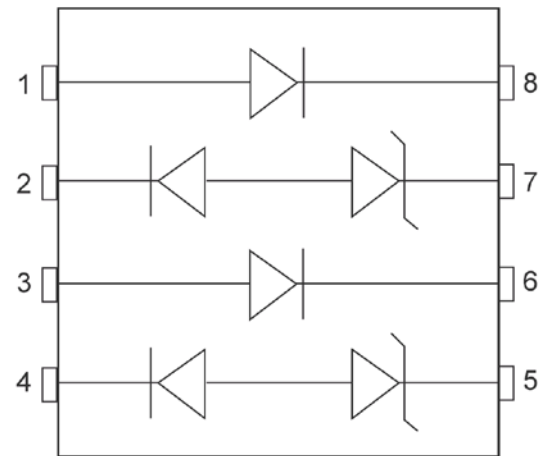
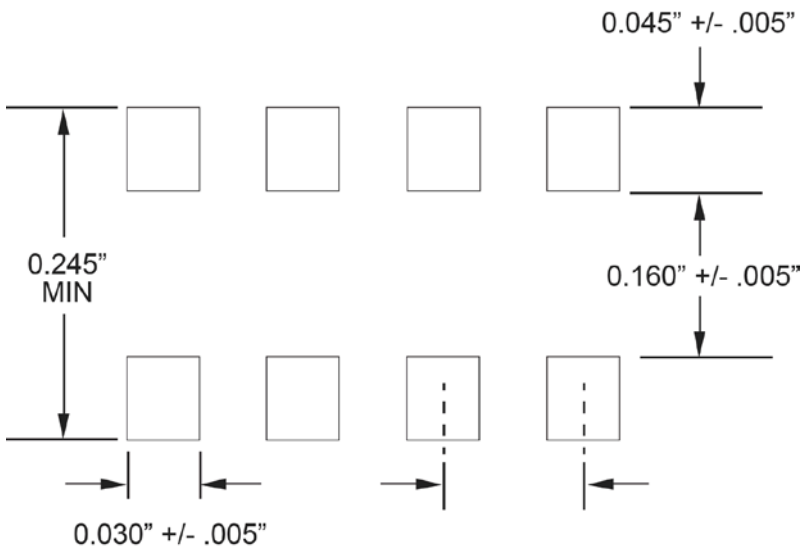

Mouser Electronics

Authorized Distributor

Click to View Pricing, Inventory, Delivery & Lifecycle Information:

Microchip:

[USB50815/TR13](#) [USB50805e3/TR7](#) [USB50815/TR7](#) [USB50803e3/TR7](#) [USB50803e3/TR13](#) [USB50803/TR7](#)
[USB50805e3/TR13](#) [USB50803/TR13](#) [USB50805/TR7](#) [USB50815e3/TR7](#) [USB50824e3/TR13](#) [USB50812/TR7](#)
[USB50812e3/TR7](#) [USB50815e3/TR13](#) [USB50824/TR7](#) [USB50824e3/TR7](#) [USB50805/TR13](#) [USB50812e3/TR13](#)

Компания «Life Electronics» занимается поставками электронных компонентов импортного и отечественного производства от производителей и со складов крупных дистрибьюторов Европы, Америки и Азии.

С конца 2013 года компания активно расширяет линейку поставок компонентов по направлению коаксиальный кабель, кварцевые генераторы и конденсаторы (керамические, пленочные, электролитические), за счёт заключения дистрибьюторских договоров

Мы предлагаем:

- Конкуренеспособные цены и скидки постоянным клиентам.
- Специальные условия для постоянных клиентов.
- Подбор аналогов.
- Поставку компонентов в любых объемах, удовлетворяющих вашим потребностям.
- Приемлемые сроки поставки, возможна ускоренная поставка.
- Доставку товара в любую точку России и стран СНГ.
- Комплексную поставку.
- Работу по проектам и поставку образцов.
- Формирование склада под заказчика.
- Сертификаты соответствия на поставляемую продукцию (по желанию клиента).
- Тестирование поставляемой продукции.
- Поставку компонентов, требующих военную и космическую приемку.
- Входной контроль качества.
- Наличие сертификата ISO.

В составе нашей компании организован Конструкторский отдел, призванный помогать разработчикам, и инженерам.

Конструкторский отдел помогает осуществить:

- Регистрацию проекта у производителя компонентов.
- Техническую поддержку проекта.
- Защиту от снятия компонента с производства.
- Оценку стоимости проекта по компонентам.
- Изготовление тестовой платы монтаж и пусконаладочные работы.



Тел: +7 (812) 336 43 04 (многоканальный)
Email: org@lifeelectronics.ru