

The products listed in this catalog are only a few of the thousands of variations that TUSONIX produces. For custom component design, please contact the factory direct.

Catalog 4000R7
Part 2
Revised 4/10/07

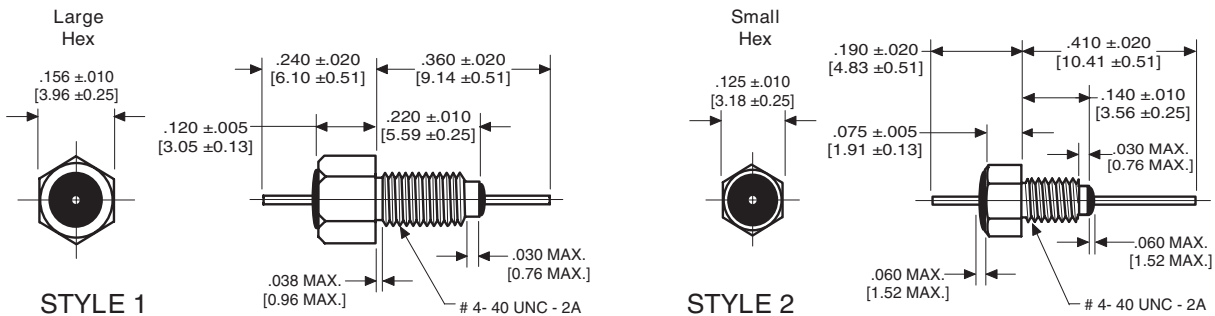

#4-40 UNC-2A Pi & C Filters



inches
[mm]

| TUSONIX Part Number | Style | Lead Dia. | Circuit | Working Voltage (dc) | | Capacitance (pF) | Capacitance Tolerance | Current (A) | Minimum No-Load Insertion Loss (dB) at 25°C per MIL-Std-220 | | | | |
|-------------------------|-------|------------|---------|----------------------|-------|------------------|-----------------------|-------------|---|-------|--------|------|-------|
| | | | | 85°C | 125°C | | | | 1MHz | 10MHz | 100MHz | 1GHz | 10GHz |
| Pi Configuration | | | | | | | | | | | | | |
| 4261-001 | 1 | .018 [.46] | Pi | -- | 50 | 5500 | GMV | 3 | -- | 14 | 55 | 70 | -- |
| 4200-012 | 1 | .018 [.46] | Pi | -- | 200 | 1500 | -0,+100% | 3 | -- | 5 | 42 | 70 | -- |
| C Configuration | | | | | | | | | | | | | |
| 4403-035 | 2 | .030 [.76] | C | 70 | 50 | 10,000 | GMV | 10 | 4 | 21 | 35 | 50 | 60 |
| 4400-005 | 1 | .020 [.51] | C | 70 | 50 | 10,000 | GMV | 10 | 4 | 21 | 35 | 50 | 60 |
| 4400-035 | 1 | .030 [.76] | C | 70 | 50 | 10,000 | GMV | 10 | 4 | 21 | 35 | 50 | 60 |
| 4403-005 | 2 | .020 [.51] | C | 70 | 50 | 10,000 | GMV | 10 | 4 | 21 | 35 | 50 | 60 |
| 4400-006 | 1 | .020 [.51] | C | 70 | 50 | 15,000 | GMV | 10 | 7 | 20 | 35 | 55 | 60 |
| 4400-036 | 1 | .030 [.76] | C | 70 | 50 | 15,000 | GMV | 10 | 7 | 20 | 35 | 55 | 60 |
| 4403-006 | 2 | .020 [.51] | C | 70 | 50 | 15,000 | GMV | 10 | 7 | 20 | 35 | 55 | 60 |
| 4403-036 | 2 | .030 [.76] | C | 70 | 50 | 15,000 | GMV | 10 | 7 | 20 | 35 | 55 | 60 |
| 4400-010 | 1 | .020 [.51] | C | 70 | 50 | 27,000 | GMV | 10 | 10 | 28 | 42 | 65 | 65 |
| 4400-040 | 1 | .030 [.76] | C | 70 | 50 | 27,000 | GMV | 10 | 10 | 28 | 42 | 65 | 65 |
| 4403-010 | 2 | .020 [.51] | C | 70 | 50 | 27,000 | GMV | 10 | 10 | 28 | 42 | 65 | 65 |
| 4403-040 | 2 | .030 [.76] | C | 70 | 50 | 27,000 | GMV | 10 | 10 | 28 | 42 | 65 | 65 |
| 4400-016 | 1 | .020 [.51] | C | 50 | 50 | 50,000 | GMV | 10 | 15 | 35 | 45 | 70 | -- |
| 4400-041 | 1 | .030 [.76] | C | 50 | 50 | 50,000 | GMV | 10 | 15 | 35 | 45 | 70 | -- |
| 4400-003 | 1 | .020 [.51] | C | 150 | 100 | 2700 | GMV | 10 | -- | 10 | 25 | 40 | 50 |
| 4400-033 | 1 | .030 [.76] | C | 150 | 100 | 2700 | GMV | 10 | -- | 10 | 25 | 40 | 50 |
| 4403-003 | 2 | .020 [.51] | C | 150 | 100 | 2700 | GMV | 10 | -- | 10 | 25 | 40 | 50 |
| 4403-033 | 2 | .030 [.76] | C | 150 | 100 | 2700 | GMV | 10 | -- | 10 | 25 | 40 | 50 |
| 4400-004 | 1 | .020 [.51] | C | 150 | 100 | 5000 | GMV | 10 | -- | 15 | 30 | 45 | 55 |
| 4400-034 | 1 | .030 [.76] | C | 150 | 100 | 5000 | GMV | 10 | -- | 15 | 30 | 45 | 55 |
| 4403-004 | 2 | .020 [.51] | C | 150 | 100 | 5000 | GMV | 10 | -- | 15 | 30 | 45 | 55 |
| 4403-034 | 2 | .030 [.76] | C | 150 | 100 | 5000 | GMV | 10 | -- | 15 | 30 | 45 | 55 |
| 4400-680 | 1 | .030 [.76] | C | 300 | 200 | 5 | MAX | 10 | -- | -- | -- | -- | -- |
| 4403-680 | 2 | .030 [.76] | C | 300 | 200 | 5 | MAX | 10 | -- | -- | -- | -- | -- |
| 4400-008 | 1 | .020 [.51] | C | 300 | 200 | 10 | GMV | 10 | -- | -- | -- | 5 | 20 |
| 4400-038 | 1 | .030 [.76] | C | 300 | 200 | 10 | GMV | 10 | -- | -- | -- | 5 | 20 |
| 4403-008 | 2 | .020 [.51] | C | 300 | 200 | 10 | GMV | 10 | -- | -- | -- | 5 | 20 |
| 4403-038 | 2 | .030 [.76] | C | 300 | 200 | 10 | GMV | 10 | -- | -- | -- | 5 | 20 |

Drawings not to scale.

All bushing style filters include hex nut and lock washer unless otherwise noted.

#4-40 UNC-2A C & L Filters

TUSONIX 4400 Series Miniature EMI Filters

These filters are ideal for applications where small size and high performance are critical and a threaded mounting technique is desired.

These C and L configured filters are available in two physical configurations and can be supplied with either unified or metric thread (see page 18 for metric). The small package and large range of electrical characteristics of the 4400 Series make it an effective solution for a variety of micro-wave applications.



| TUSONIX Part Number | Style | Lead Dia. | Circuit | Working Voltage (dc) | | Capacitance (pF) | Capacitance Tolerance | Current (A) | Minimum No-Load Insertion Loss (dB) at 25°C per MIL-Std-220 | | | | |
|---|-------|------------|---------|----------------------|-------|------------------|-----------------------|-------------|---|-------|--------|------|-------|
| | | | | 85°C | 125°C | | | | 1MHz | 10MHz | 100MHz | 1GHz | 10GHz |
| C Configuration (Continued from page 13) | | | | | | | | | | | | | |
| 4400-009 | 1 | .020 [.51] | C | 300 | 200 | 25 | GMV | 10 | -- | -- | -- | 10 | 25 |
| 4400-039 | 1 | .030 [.76] | C | 300 | 200 | 25 | GMV | 10 | -- | -- | -- | 10 | 25 |
| 4403-009 | 2 | .020 [.51] | C | 300 | 200 | 25 | GMV | 10 | -- | -- | -- | 10 | 25 |
| 4403-039 | 2 | .030 [.76] | C | 300 | 200 | 25 | GMV | 10 | -- | -- | -- | 10 | 25 |
| 4400-000 | 1 | .020 [.51] | C | 300 | 200 | 100 | GMV | 10 | -- | -- | 3 | 20 | 28 |
| 4400-030 | 1 | .030 [.76] | C | 300 | 200 | 100 | GMV | 10 | -- | -- | 3 | 20 | 28 |
| 4403-000 | 2 | .020 [.51] | C | 300 | 200 | 100 | GMV | 10 | -- | -- | 3 | 20 | 28 |
| 4403-030 | 2 | .030 [.76] | C | 300 | 200 | 100 | GMV | 10 | -- | -- | 3 | 20 | 28 |
| 4400-001 | 1 | .020 [.51] | C | 300 | 200 | 500 | GMV | 10 | -- | -- | 15 | 35 | 40 |
| 4400-031 | 1 | .030 [.76] | C | 300 | 200 | 500 | GMV | 10 | -- | -- | 15 | 35 | 40 |
| 4403-001 | 2 | .020 [.51] | C | 300 | 200 | 500 | GMV | 10 | -- | -- | 15 | 35 | 40 |
| 4403-031 | 2 | .030 [.76] | C | 300 | 200 | 500 | GMV | 10 | -- | -- | 15 | 35 | 40 |
| 4400-007 | 1 | .020 [.51] | C | 300 | 200 | 1000 | GMV | 10 | -- | 5 | 20 | 35 | 45 |
| 4400-037 | 1 | .030 [.76] | C | 300 | 200 | 1000 | GMV | 10 | -- | 5 | 20 | 35 | 45 |
| 4403-007 | 2 | .020 [.51] | C | 300 | 200 | 1000 | GMV | 10 | -- | 5 | 20 | 35 | 45 |
| 4403-037 | 2 | .030 [.76] | C | 300 | 200 | 1000 | GMV | 10 | -- | 5 | 20 | 35 | 45 |
| 4400-002 | 1 | .020 [.51] | C | 300 | 200 | 1200 | GMV | 10 | -- | 5 | 20 | 35 | 45 |
| 4400-032 | 1 | .030 [.76] | C | 300 | 200 | 1200 | GMV | 10 | -- | 5 | 20 | 35 | 45 |
| 4403-002 | 2 | .020 [.51] | C | 300 | 200 | 1200 | GMV | 10 | -- | 5 | 20 | 35 | 45 |
| 4403-032 | 2 | .030 [.76] | C | 300 | 200 | 1200 | GMV | 10 | -- | 5 | 20 | 35 | 45 |
| L Configuration | | | | | | | | | | | | | |
| 4400-055 | 1 | .020 [.51] | L | 70 | 50 | 10,000 | GMV | 10 | 4 | 21 | 35 | 55 | 70 |
| 4400-056 | 1 | .020 [.51] | L | 70 | 50 | 15,000 | GMV | 10 | 7 | 25 | 40 | 60 | 60 |
| 4400-060 | 1 | .020 [.51] | L | 70 | 50 | 27,000 | GMV | 10 | 10 | 28 | 45 | 65 | 70 |
| 4400-057 | 1 | .020 [.51] | L | 50 | 50 | 50,000 | GMV | 10 | 15 | 35 | 52 | 70 | -- |
| 4400-053 | 1 | .020 [.51] | L | 150 | 100 | 2700 | GMV | 10 | -- | 10 | 25 | 40 | 55 |
| 4400-054 | 1 | .020 [.51] | L | 150 | 100 | 5000 | GMV | 10 | -- | 15 | 30 | 45 | 60 |
| 4400-050 | 1 | .020 [.51] | L | 300 | 200 | 100 | GMV | 10 | -- | -- | 3 | 20 | 33 |
| 4400-051 | 1 | .020 [.51] | L | 300 | 200 | 500 | GMV | 10 | -- | -- | 15 | 35 | 45 |
| 4400-052 | 1 | .020 [.51] | L | 300 | 200 | 1200 | GMV | 10 | -- | 5 | 20 | 35 | 50 |

Drawings not to scale.

Please Note: All bushing style filters include hex nut and lock washer unless otherwise noted.

The products listed in this catalog are only a few of the thousands of variations that TUSONIX produces. For custom component design, please contact the factory direct.



#6-40 UNF-2A EMI Pi Filters

inches
[mm]

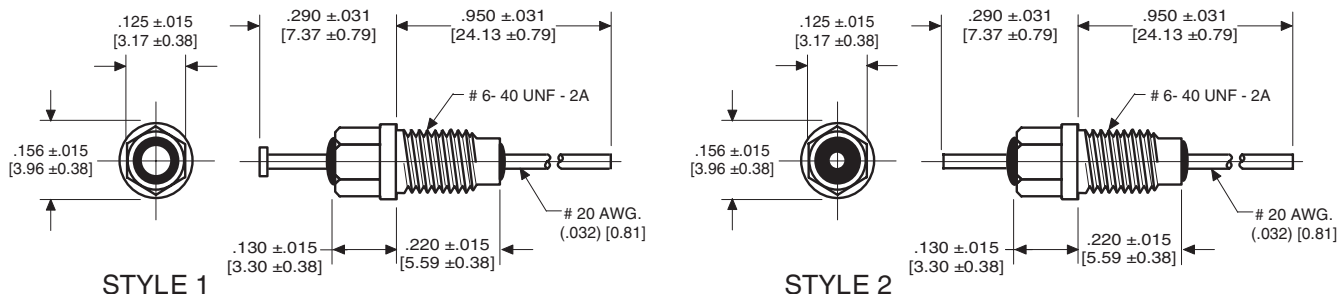

| TUSONIX Part Number | Style | Circuit | Working Voltage (dc) | | Capacitance (pF) | Capacitance Tolerance | Current (A) | Minimum No-Load Insertion Loss (dB) at 25°C per MIL-Std-220 | | | |
|-------------------------|-------|---------|----------------------|-------|------------------|-----------------------|-------------|---|--------|------|-------|
| | | | 85°C | 125°C | | | | 10MHz | 100MHz | 1GHz | 10GHz |
| Pi Configuration | | | | | | | | | | | |
| 4200-000 | 1 | Pi | 300 | 200 | 1500 | GMV | 10 | 5 | 40 | 60 | 60 |
| 4200-002 | 2 | Pi | 300 | 200 | 1500 | GMV | 10 | 5 | 40 | 60 | 60 |
| 4200-005 | 1 | Pi | 300 | 200 | 3000 | GMV | 10 | 8 | 50 | 70 | 70 |

Drawings not to scale.

Please Note: All bushing style filters include hex nut and lock washer unless otherwise noted.

MIL PARTS CROSS REFERENCE

| MIL-PRF-15733 | TUSONIX No. | Page No. ❖ | MIL-PRF-15733 | TUSONIX No. | Page No. ❖ |
|---------------|-------------|------------|---------------|-------------|------------|
| /28-0001 | 4201-501 | 18 | /61-0001 | 4204-500 | 19 |
| /28-0002 | 4201-503 | 18 | /61-0002 | 4202-501 | 20 |
| /28-0003 | 4251-503 | NS | /61-0003 | 4206-502 | 21 |
| /33-0001 | 4101-502 | 12 | /61-0004 | 4206-501 | 21 |
| /33-0002 | 4101-503 | 12 | /61-0005 | 4203-502 | NS |
| /38-0004 | 4601-503 | NS | /61-0006 | 4203-501 | 20 |
| /38-0005 | 4601-504 | NS | /61-0007 | 4203-552 | 20 |
| /43-0001 | 4204-501 | 19 | /61-0008 | 4201-502 | 18 |
| /43-0002 | 4201-506 | NS | /61-0009 | 4253-500 | NS |
| /44-0001 | 4251-500 | NS | /61-0010 | 4203-553 | 20 |
| /44-0002 | 4205-500 | NS | /61-0011 | 4203-551 | 20 |
| /44-0003 | 4205-501 | NS | /61-0012 | 4253-501 | NS |
| /46-0001 | 4207-500 | NS | /61-0013 | 4251-502 | NS |
| /49-0001 | 4601-502 | NS | /61-0014 | 4251-501 | NS |
| /49-0006 | 4601-501 | NS | /62-0001 | 4101-501 | 12 |
| /49-0007 | 4601-500 | NS | /62-0002 | 4100-500 | 12 |
| /51-0001 | 4101-504 | 12 | /62-0003 | 4101-505 | 12 |
| /51-0002 | 4151-501 | 12 | /62-0004 | 4151-500 | 12 |
| | | | /66-0001 | 4101-500 | 12 |

❖ NS indicates a part that is not shown in this catalog.

#6-32 UNC-2A Pi, C & L Filters and Feed-thru Capacitors

inches
[mm]

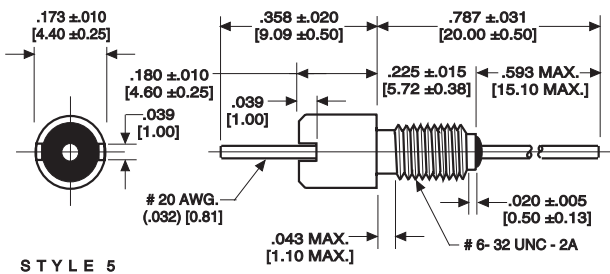
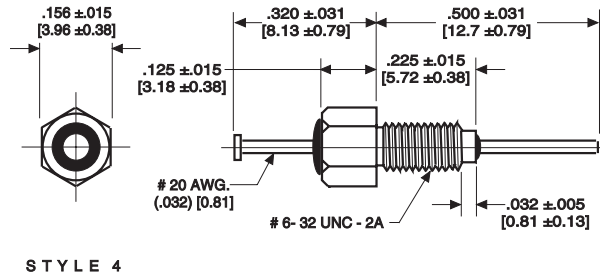
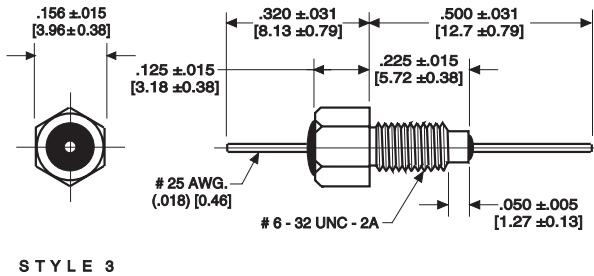
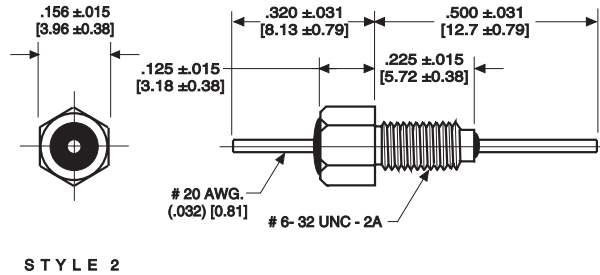
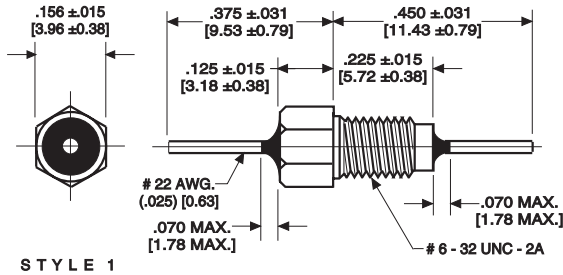

| TUSONIX Part Number | Temperature Range | WVDC | MAX. CAP. (Nominal) (pF) |
|---------------------|-------------------|------|--------------------------|
| 2430 | Z5, Y5, X5 | 200 | 1500 |
| | X7 | 100 | 1500 |

| Notes: |
|-----------------------------|
| •• Typical Insertion Loss |
| ∇ No Hex Nut or Lock Washer |

Please see Temperature Characteristics and EIA Codes on page 25.

| TUSONIX Part Number | Style | Notes | Circuit | Working Voltage (dc) | | Capacitance (pF) | Capacitance Tolerance | Current (A) | Minimum No-Load Insertion Loss (dB) at 25°C per MIL-Std-220 | | | | |
|-------------------------|-------|-------|---------|----------------------|-------|------------------|-----------------------|-------------|---|-------|--------|------|-------|
| | | | | 85°C | 125°C | | | | 1MHz | 10MHz | 100MHz | 1GHz | 10GHz |
| Pi Configuration | | | | | | | | | | | | | |
| 4260-001 | 3 | -- | Pi | -- | 50 | 5500 | GMV | 3 | -- | 14 | 55 | 70 | -- |
| 4260-002 | 3 | -- | Pi | -- | 50 | 7500 | GMV | 3 | -- | 18 | 65 | 70 | -- |
| 4260-000 | 3 | -- | Pi | 400 | 200 | 2000 | GMV | 3 | -- | 5 | 42 | 70 | -- |
| C Configuration | | | | | | | | | | | | | |
| 4402-016 | 2 | -- | C | 50 | 50 | 50,000 | GMV | 10 | 15 | 35 | 45 | 70 | -- |
| 4402-005 | 2 | -- | C | 100 | 100 | 10,000 | GMV | 10 | 4 | 21 | 35 | 50 | -- |
| 4402-018 | 2 | -- | C | 50 | 50 | 100,000 | GMV | 10 | 22 | 40 | 47 | 65 | 65 |
| 4402-680 | 5 | ∇ | C | 300 | 200 | 5 | MAX | 10 | -- | -- | -- | -- | -- |
| 2430-003-X5F0-101M | 1 | •• | C | 200 | 100 | 100 | ±20% | 5 | -- | -- | 3 | 20 | 28 |
| 2430-003-X5F0-102Z | 1 | •• | C | 200 | 100 | 1000 | +80-20% | 5 | -- | 3 | 20 | 35 | 40 |
| L Configuration | | | | | | | | | | | | | |
| 4402-063 | 5 | ∇ | L | 200 | 100 | 4700 | +80-20 | 10 | -- | 15 | 30 | 45 | 55 |
| 4402-060 | 4 | -- | L | 100 | 100 | 27,000 | GMV | 10 | 10 | 28 | 45 | 65 | -- |

Drawings not to scale.

Please Note: All bushing style filters include hex nut and lock washer unless otherwise noted.

The products listed in this catalog are only a few of the thousands of variations that TUSONIX produces. For custom component design, please contact the factory direct.



#8-32 UNC-2A Pi, C & L Filters and Feed-Thru Capacitors

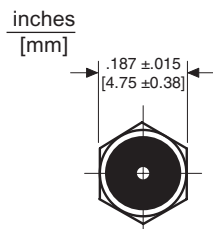

STYLE 1

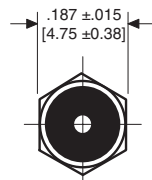
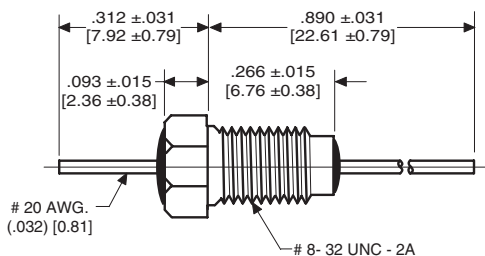

STYLE 2

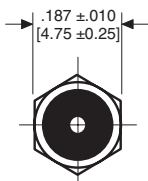
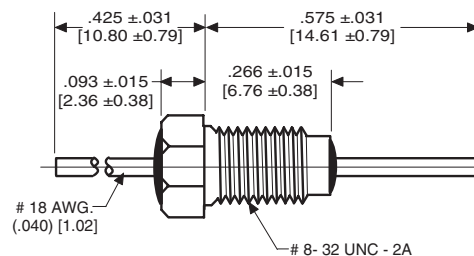

STYLE 3

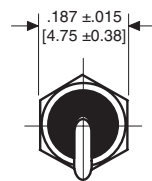
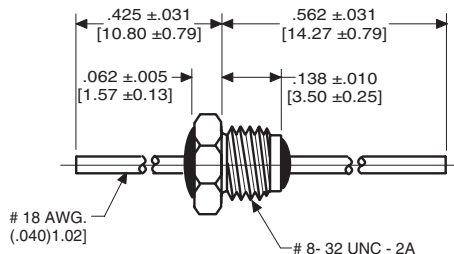

STYLE 4

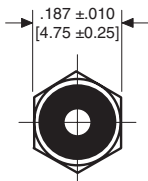
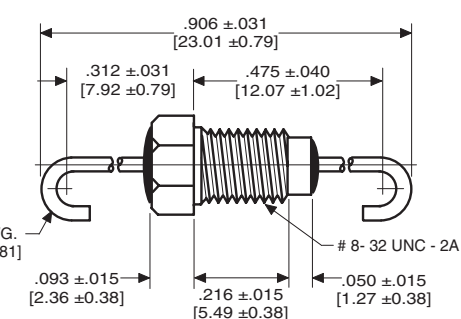

STYLE 5

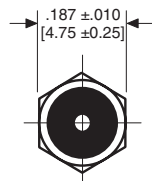
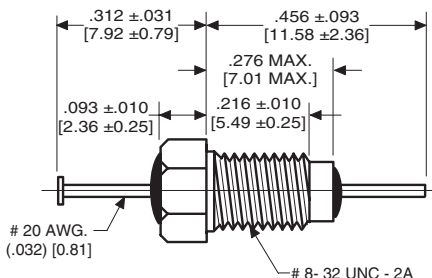

STYLE 6

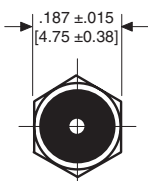
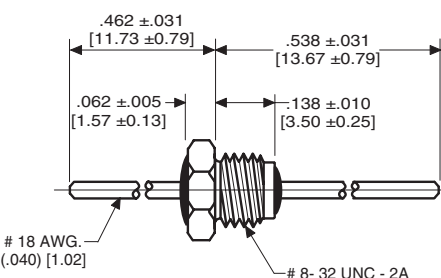

STYLE 7

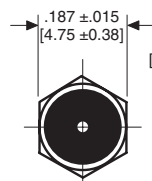
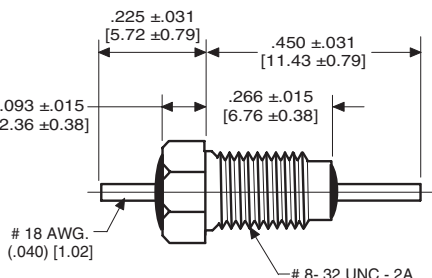

STYLE 8

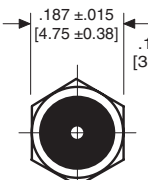
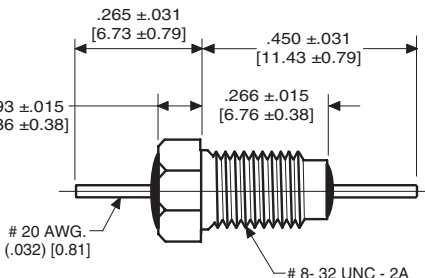

STYLE 9

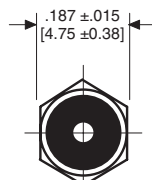
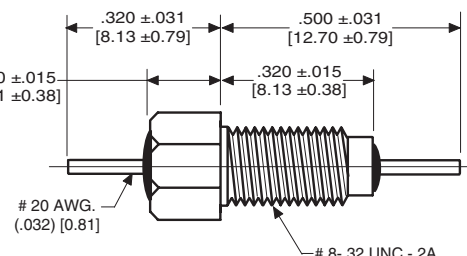

STYLE 10

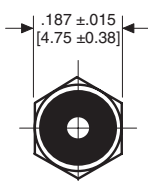
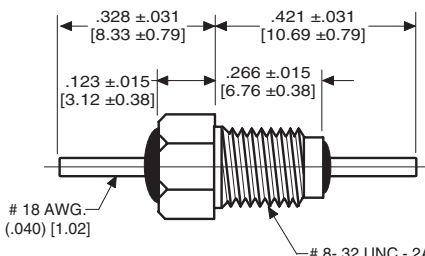

STYLE 11

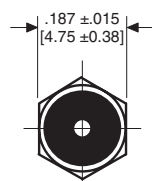
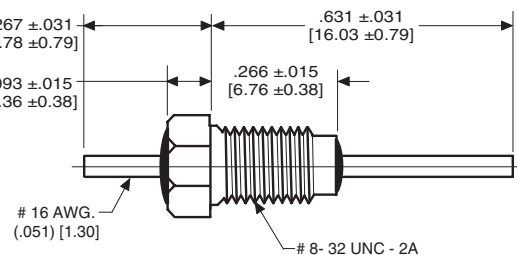

STYLE 12

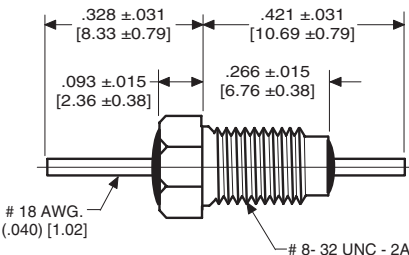

#8-32 UNC-2A Pi, C & L Filters and Feed-Thru Capacitors

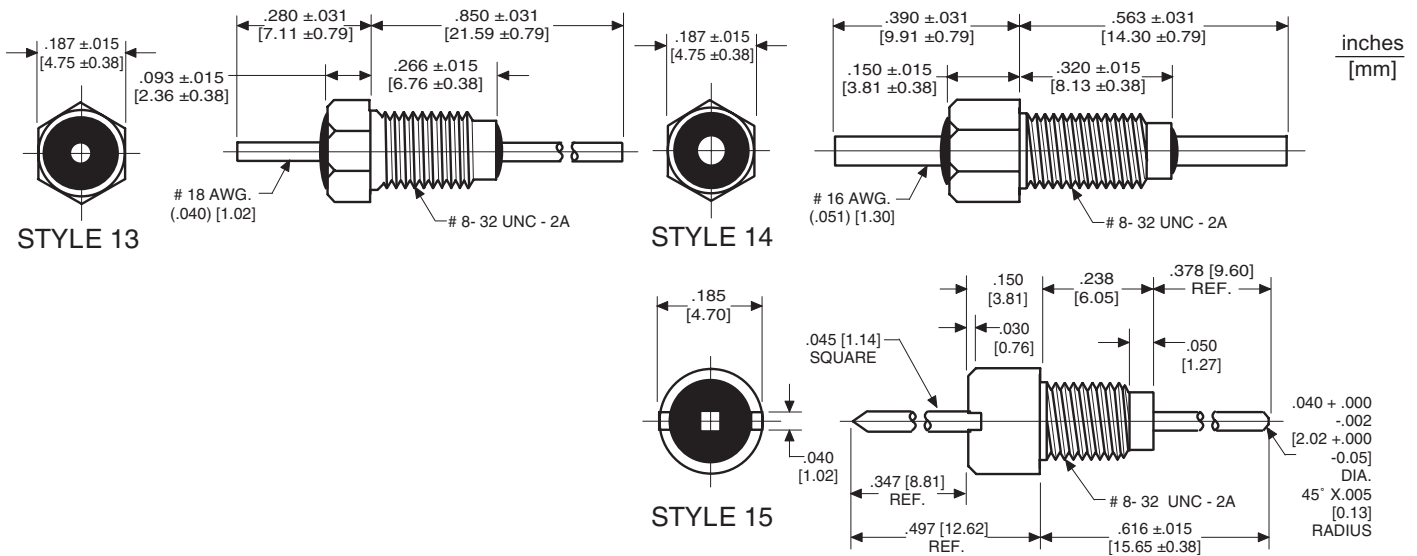

| Series Number | Temperature Range | WVdc | MAX. Cap. (Nominal) (pF) |
|---------------|-------------------|------|--------------------------|
| 2425 | Z5, Y5, X5 | 200 | 10,000 |
| | X7 | 100 | 10,000 |

Notes:

- ◆ Turret Lead
- ▽ #18 AWG Lead 0.040 Dia.
- Typical Insertion Loss
- No hex nut or Lockwasher

Please see Temperature Characteristics and EIA Codes on page 25.

| TUSONIX Part Number | MIL-PRF-15733 Number | Style | Notes | Circuit | Working Voltage (dc) | | Capacitance (pF) | Capacitance Tolerance | Current (A) | Minimum No-Load Insertion Loss (dB) at 25°C per MIL-Std-220 | | | | |
|-------------------------|----------------------|-------|-------|---------|----------------------|-------|------------------|-----------------------|-------------|---|-------|--------|------|-------|
| | | | | | 85°C | 125°C | | | | 1MHz | 10MHz | 100MHz | 1GHz | 10GHz |
| Pi Configuration | | | | | | | | | | | | | | |
| 4251-001 | -- | 8 | -- | Pi | -- | 50 | 15,000 | GMV | 10 | 5 | 18 | 65 | 70 | -- |
| 4201-048 | -- | 15 | □ | Pi | 200 | 100 | 100 | GMV | 15 | -- | -- | 5 | 32 | -- |
| 4201-047 | -- | 15 | □ | Pi | 200 | 100 | 1000 | GMV | 15 | -- | 4 | 37 | 60 | -- |
| 4201-502 | /61-0008 | 5 | -- | Pi | -- | 100 | 1000 | GMV | 10 | -- | -- | 65 | 70 | 70 |
| 4201-000 | -- | 1 | -- | Pi | 200 | 100 | 1500 | GMV | 10 | -- | 5 | 45 | 65 | 70 |
| 4201-001 | -- | 1 | ◆ | Pi | 200 | 100 | 1500 | GMV | 10 | -- | 5 | 45 | 65 | 70 |
| 4201-004 | -- | 1 | ▽ | Pi | 200 | 100 | 1500 | GMV | 15 | -- | 5 | 38 | 63 | 70 |
| 4201-006 | -- | 1 | ◆▽ | Pi | 200 | 100 | 1500 | GMV | 15 | -- | 5 | 38 | 63 | 70 |
| 4201-501 | /28-0001 | 1 | ◆ | Pi | -- | 100 | 1500 | GMV | 10 | -- | -- | 45 | 60 | 60 |
| 4201-503 | /28-0002 | 4 | -- | Pi | -- | 100 | 1500 | GMV | 10 | -- | -- | 45 | 60 | 60 |
| 4201-003 | -- | 2 | -- | Pi | 200 | 100 | 2000 | GMV | 15 | -- | 5 | 38 | 63 | 70 |
| 4201-050 | -- | 1 | -- | Pi | 200 | 100 | 5500 | GMV | 10 | -- | 14 | 55 | 70 | 70 |
| 4201-051 | -- | 1 | ◆ | Pi | 200 | 100 | 5500 | GMV | 10 | -- | 14 | 55 | 70 | 70 |
| 4201-053 | -- | 1 | ◆▽ | Pi | 200 | 100 | 5500 | GMV | 15 | -- | 14 | 55 | 65 | 65 |
| 4201-083 | -- | 9 | -- | Pi | 200 | 100 | 10,000 | +80-20% | 10 | -- | 18 | 65 | 70 | 70 |
| 4251-004 | -- | 9 | -- | Pi | 100 | 100 | 28,000 | GMV | 10 | 10 | 38 | 75 | 75 | 75 |
| 4205-002 | -- | 3 | -- | Pi | 250 | 125 | 65 | +100-0% | 15 | -- | -- | 3 | 16 | 45 |
| 4205-018 | -- | 6 | -- | Pi | 250 | 125 | 65 | +100-0% | 15 | -- | -- | 3 | 16 | 45 |
| 4205-017 | -- | 6 | -- | Pi | 250 | 125 | 1500 | GMV | 15 | -- | 5 | 35 | 60 | 60 |
| 4205-001 | -- | 3 | -- | Pi | 250 | 125 | 1500 | GMV | 15 | -- | 5 | 35 | 60 | 60 |
| 4251-000 | -- | 7 | -- | Pi | 185 | 125 | 3000 | +100-0% | 15 | -- | 10 | 30 | 65 | 65 |
| 4251-002 | -- | 9 | -- | Pi | 200 | 125 | 12,000 | GMV | 10 | 5 | 28 | 65 | 70 | 70 |
| C Configuration | | | | | | | | | | | | | | |
| 2425-018-X5U0-101M | -- | 11 | ◆◆ | C | 200 | 100 | 100 | ±20% | 20 | -- | -- | 3 | 20 | 28 |
| 2425-544-X7R0-101M | -- | 11 | ◆◆ | C | 200 | 100 | 100 | ±20% | 20 | -- | -- | 3 | 20 | 28 |
| 2425-018-X5U0-102M | -- | 11 | ◆◆ | C | 200 | 100 | 1000 | ±20% | 20 | -- | 3 | 20 | 35 | 40 |
| 2425-544-X7R0-102P | -- | 11 | ◆◆ | C | 200 | 100 | 1000 | +100-0% | 20 | -- | 3 | 20 | 35 | 40 |
| 2425-018-X5W0-502M | -- | 11 | ◆◆ | C | 200 | 100 | 5000 | ±20% | 20 | -- | 15 | 30 | 45 | 50 |
| 2425-601-X5W0-103Z | -- | 14 | ◆◆ | C | 200 | 100 | 10,000 | +80-20% | 20 | -- | 20 | 35 | 50 | 55 |
| 4404-001 | -- | 1 | ◆ | C | 100 | 100 | 27,000 | GMV | 10 | 10 | 30 | 45 | 55 | -- |
| 4404-002 | -- | 12 | -- | C | 140 | 100 | 50,000 | GMV | 10 | 15 | 34 | 45 | 60 | -- |
| 4404-003 | -- | 10 | -- | C | -- | 100 | 100,000 | GMV | 10 | 20 | 38 | 47 | 65 | -- |
| L Configuration | | | | | | | | | | | | | | |
| 4404-050 | -- | 13 | -- | L | -- | 100 | 22,000 | GMV | 10 | 7 | 27 | 43 | 60 | -- |

Drawings not to scale.

Please Note: All bushing style filters include hex nut and lock washer unless otherwise noted.

The products listed in this catalog are only a few of the thousands of variations that TUSONIX produces. For custom component design, please contact the factory direct.



#8-36 UNF-2A and #12-28 UNF-2A Pi & C Filters and Feed-Thru Capacitors

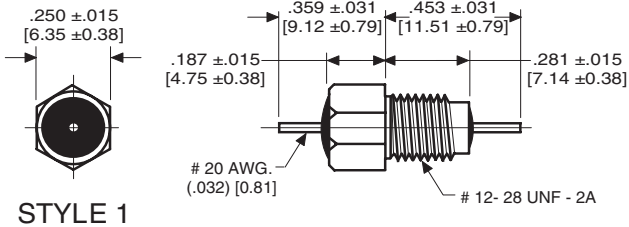

STYLE 1

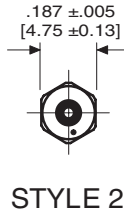

STYLE 2

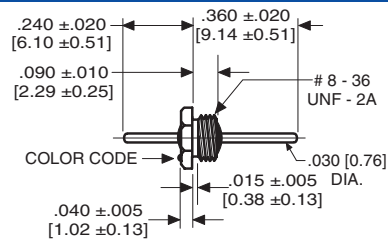

inches
[mm]

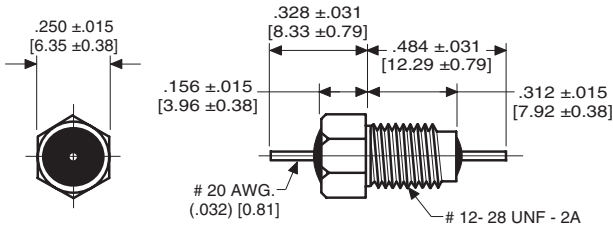

STYLE 3

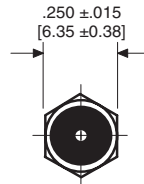

STYLE 4

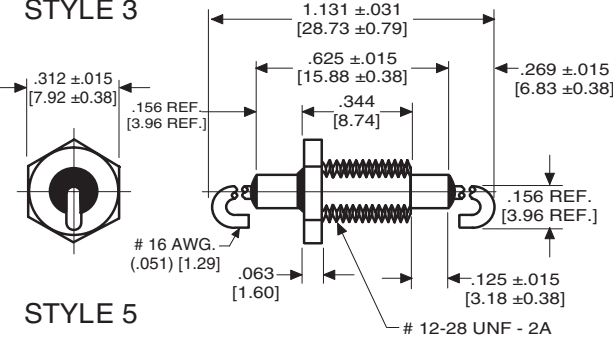
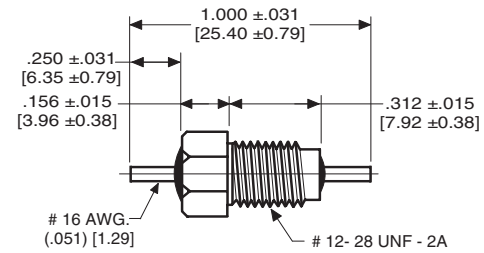

STYLE 5

| Series Number | Temperature Range | WVDC | MAX. CAP. Nominal (pF) |
|---------------|-------------------|------|------------------------|
| 2499 | Z5, Y5, X5 | 500 | 10,000 |
| | X7 | 250 | 10,000 |
| 357 | Z5, Y5, X5 | 500 | 10,000 |
| | X7 | 250 | 10,000 |

| Notes: | |
|--------|------------------------|
| ◆ | Turret Lead |
| ● | Typical Insertion Loss |
| ▽ | No Hex Nut Included |

Please see Temperature Characteristics and EIA Codes on Page 25.

| TUSONIX Part Number | MIL-PRF-15733 Number | Style | Notes | Circuit | Working Voltage (dc) | | Capacitance (pF) | Capacitance Tolerance | Current (A) | Minimum No-Load Insertion Loss (dB) at 25°C per MIL-Std-220 | | | | |
|-------------------------|----------------------|-------|-------|---------|----------------------|----------------|------------------|-----------------------|-------------|---|-------|--------|------|-------|
| | | | | | 85°C | 125°C | | | | 1MHz | 10MHz | 100MHz | 1GHz | 10GHz |
| C Configuration | | | | | | | | | | | | | | |
| 4401-005 | -- | 2 | ▽ | C | 70 | 50 | 10,000 | GMV | 10 | 4 | 21 | 35 | 50 | 60 |
| 4401-006 | -- | 2 | ▽ | C | 70 | 50 | 15,000 | GMV | 10 | 7 | 20 | 35 | 55 | 60 |
| 4401-010 | -- | 2 | ▽ | C | 70 | 50 | 27,000 | GMV | 10 | 10 | 28 | 42 | 65 | 65 |
| 4401-011 | -- | 2 | ▽ | C | 50 | 50 | 50,000 | GMV | 10 | 15 | 35 | 45 | 70 | -- |
| 4401-003 | -- | 2 | ▽ | C | 150 | 100 | 2700 | GMV | 10 | -- | 10 | 25 | 40 | 50 |
| 4401-004 | -- | 2 | ▽ | C | 150 | 100 | 5000 | GMV | 10 | -- | 15 | 30 | 45 | 55 |
| 4401-680 | -- | 2 | ▽ | C | 300 | 200 | 5 | MAX | 10 | -- | -- | -- | -- | -- |
| 4401-008 | -- | 2 | ▽ | C | 300 | 200 | 10 | GMV | 10 | -- | -- | -- | 5 | 20 |
| 4401-009 | -- | 2 | ▽ | C | 300 | 200 | 25 | GMV | 10 | -- | -- | -- | 10 | 25 |
| 4401-000 | -- | 2 | ▽ | C | 300 | 200 | 100 | GMV | 10 | -- | -- | 3 | 20 | 28 |
| 4401-001 | -- | 2 | ▽ | C | 300 | 200 | 500 | GMV | 10 | -- | -- | 15 | 35 | 40 |
| 4401-007 | -- | 2 | ▽ | C | 300 | 200 | 1000 | GMV | 10 | -- | 5 | 20 | 35 | 45 |
| 4401-002 | -- | 2 | ▽ | C | 300 | 200 | 1200 | GMV | 10 | -- | 5 | 20 | 35 | 45 |
| Pi Configuration | | | | | | | | | | | | | | |
| 4202-053 | -- | 3 | -- | Pi | 200 | 100 | 5000 | GMV | 10 | -- | 20 | 65 | 70 | 70 |
| 4202-054 | -- | 3 | ◆ | Pi | 200 | 100 | 5000 | GMV | 10 | -- | 20 | 65 | 70 | 70 |
| 4204-050 | -- | 1 | -- | Pi | 200 | 100 | 5000 | GMV | 10 | -- | 20 | 65 | 70 | 70 |
| 4204-051 | -- | 1 | ◆ | Pi | 200 | 100 | 5000 | GMV | 10 | -- | 20 | 65 | 70 | 70 |
| 4202-020 | -- | 3 | -- | Pi | 350 | 200 | 1500 | GMV | 10 | -- | 5 | 45 | 70 | 70 |
| 4202-021 | -- | 3 | ◆ | Pi | 350 | 200 | 1500 | GMV | 10 | -- | 5 | 45 | 70 | 70 |
| 4204-000 | -- | 1 | -- | Pi | 350 | 200 | 1500 | GMV | 10 | -- | 5 | 45 | 70 | 70 |
| 4204-001 | -- | 1 | ◆ | Pi | 350 | 200 | 1500 | GMV | 10 | -- | 5 | 45 | 70 | 70 |
| 4204-500 | /61-0001 | 1 | -- | Pi | -- | 200dc 140ac | 1500 | GMV | 10ac | -- | -- | 45 | 70 | 70 |
| 4204-501 | /43-0001 | 1 | ◆ | Pi | -- | 200dc 140ac | 1500 | GMV | 10ac | -- | -- | -- | 45 | 45 |
| C Configuration | | | | | | | | | | | | | | |
| 2499-003-X5U0-102P | -- | 4 | ● | C | 500 | 250 | 1000 | +100-0% | 20 | -- | 3 | 20 | 35 | 40 |
| 2499-003-X5W0-502P | -- | 4 | ● | C | 500 | 250 | 5000 | +100-0% | 20 | -- | 15 | 30 | 45 | 50 |
| 2499-003-X5W0-103Z | -- | 4 | ● | C | 500 | 250 | 10,000 | +80-20% | 20 | -- | 20 | 35 | 50 | 55 |
| 357-001-X5W0-103Z | -- | 5 | ● | C | 500 | 250 | 10,000 | +80-20% | 20 | -- | 20 | 35 | 50 | 55 |

#12-32 UNEF-2A Pi, & C Filters

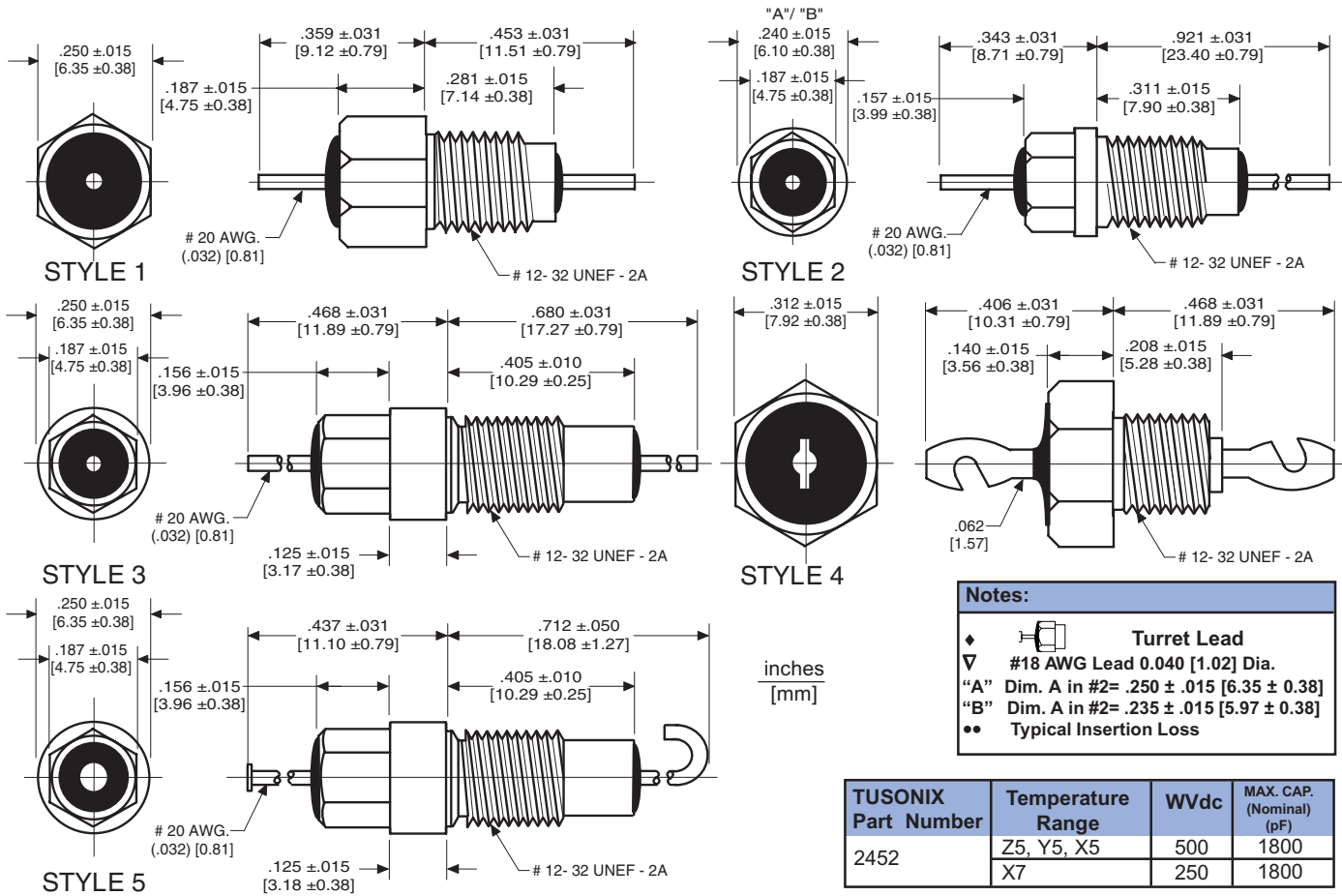

| TUSONIX Part Number | Temperature Range | WVdc | MAX. CAP. (Nominal) (pF) |
|---------------------|-------------------|------|--------------------------|
| 2452 | Z5, Y5, X5 | 500 | 1800 |
| | X7 | 250 | 1800 |

Please see Temperature Characteristics and EIA Codes on page 25.

| TUSONIX Part Number | MIL-PRF-15733 Number | Style | Notes | Circuit | Working Voltage (dc) | | Capacitance (pF) | Capacitance Tolerance | Current (A) | Minimum No-Load Insertion Loss (dB) at 25°C per MIL-Std-220 | | | |
|-------------------------|----------------------|-------|-------|---------|----------------------|-------|------------------|-----------------------|-------------|---|--------|------|-------|
| | | | | | 85°C | 125°C | | | | 10MHz | 100MHz | 1GHz | 10GHz |
| Pi Configuration | | | | | | | | | | | | | |
| 4207-003 | -- | 3 | -- | Pi | 100 | 70 | 12,000 | GMV | 10 | 45 | 70 | 70 | 70 |
| 4253-002 | -- | 3 | -- | Pi | 100 | 70 | 50,000 | GMV | 10 | 60 | 75 | 75 | 75 |
| 4202-050 | -- | 1 | -- | Pi | 200 | 100 | 5,000 | GMV | 10 | 20 | 65 | 70 | 70 |
| 4202-051 | -- | 1 | ◆ | Pi | 200 | 100 | 5,000 | GMV | 10 | 20 | 65 | 70 | 70 |
| 4203-050 | -- | 2 | -- | Pi | 200 | 100 | 5,000 | GMV | 10 | 20 | 65 | 70 | 70 |
| 4203-051 | -- | 2 | ◆ | Pi | 200 | 100 | 5,000 | GMV | 10 | 20 | 65 | 70 | 70 |
| 4203-053 | -- | 2 | ◆A | Pi | 200 | 100 | 5,000 | GMV | 10 | 20 | 65 | 70 | 70 |
| 4203-551 | /61-0011 | 2 | ◆B | Pi | -- | 100dc | 5,000 | GMV | 10ac | -- | 65 | 70 | 70 |
| 4203-553 | /61-0010 | 2 | ◆A | Pi | -- | 70dc | 5,000 | GMV | 10ac | -- | 65 | 70 | 70 |
| 4253-001 | -- | 2 | ◆ | Pi | -- | 100 | 25,000 | GMV | 10 | 30 | 65 | 70 | 70 |
| 4253-000 | -- | 3 | -- | Pi | -- | 140 | 22,000 | GMV | 10 | 45 | 75 | 75 | 75 |
| 4202-000 | -- | 1 | -- | Pi | 350 | 200 | 1,500 | GMV | 10 | 5 | 45 | 70 | 70 |
| 4203-000 | -- | 2 | -- | Pi | 350 | 200 | 1,500 | GMV | 10 | 5 | 45 | 70 | 70 |
| 4202-001 | -- | 1 | ◆ | Pi | 350 | 200 | 1,500 | GMV | 10 | 5 | 45 | 70 | 70 |
| 4202-501 | /61-0002 | 1 | ◆ | Pi | -- | 200dc | 1,500 | GMV | 10ac | -- | 45 | 70 | 70 |
| 4203-003 | -- | 2 | ◆A | Pi | 350 | 200 | 1,500 | GMV | 10 | 5 | 45 | 70 | 70 |
| 4203-501 | /61-0006 | 2 | ◆B | Pi | -- | 140dc | 1,500 | GMV | 10ac | -- | 45 | 70 | 70 |
| 4203-552 | /61-0007 | 2 | ◆A | Pi | -- | 100dc | 5,000 | GMV | 10ac | -- | 65 | 70 | 70 |
| 4207-000 | -- | 5 | -- | Pi | 500 | 300 | 1,200 | GMV | 10 | 5 | 43 | 55 | 55 |
| 4207-001 | -- | 5 | -- | Pi | 500 | 300 | 4,000 | GMV | 10 | 15 | 55 | 60 | 60 |
| 4202-004 | -- | 1 | ▽ | Pi | 500 | 350 | 2,500 | GMV | 15 | 5 | 50 | 70 | 70 |
| C Configuration | | | | | | | | | | | | | |
| 2452-000-X7R0-101M | -- | 4 | ●● | C | 500 | 250 | 100 | ±20% | 20 | -- | 3 | 28 | 28 |
| 2452-000-X7R0-471M | -- | 4 | ●● | C | 500 | 250 | 470 | ±20% | 20 | -- | 12 | 27 | 27 |
| 2452-000-X5U0-102P | -- | 4 | ●● | C | 500 | 250 | 1,000 | +100-0% | 20 | 3 | 20 | 35 | 40 |

The products listed in this catalog are only a few of the thousands of variations that TUSONIX produces. For custom component design, please contact the factory direct.



1/4-28 and 5/16-24 UNF-2A and 5/16-32 UNEF-2A Pi Filters and Feed-Thru Capacitors

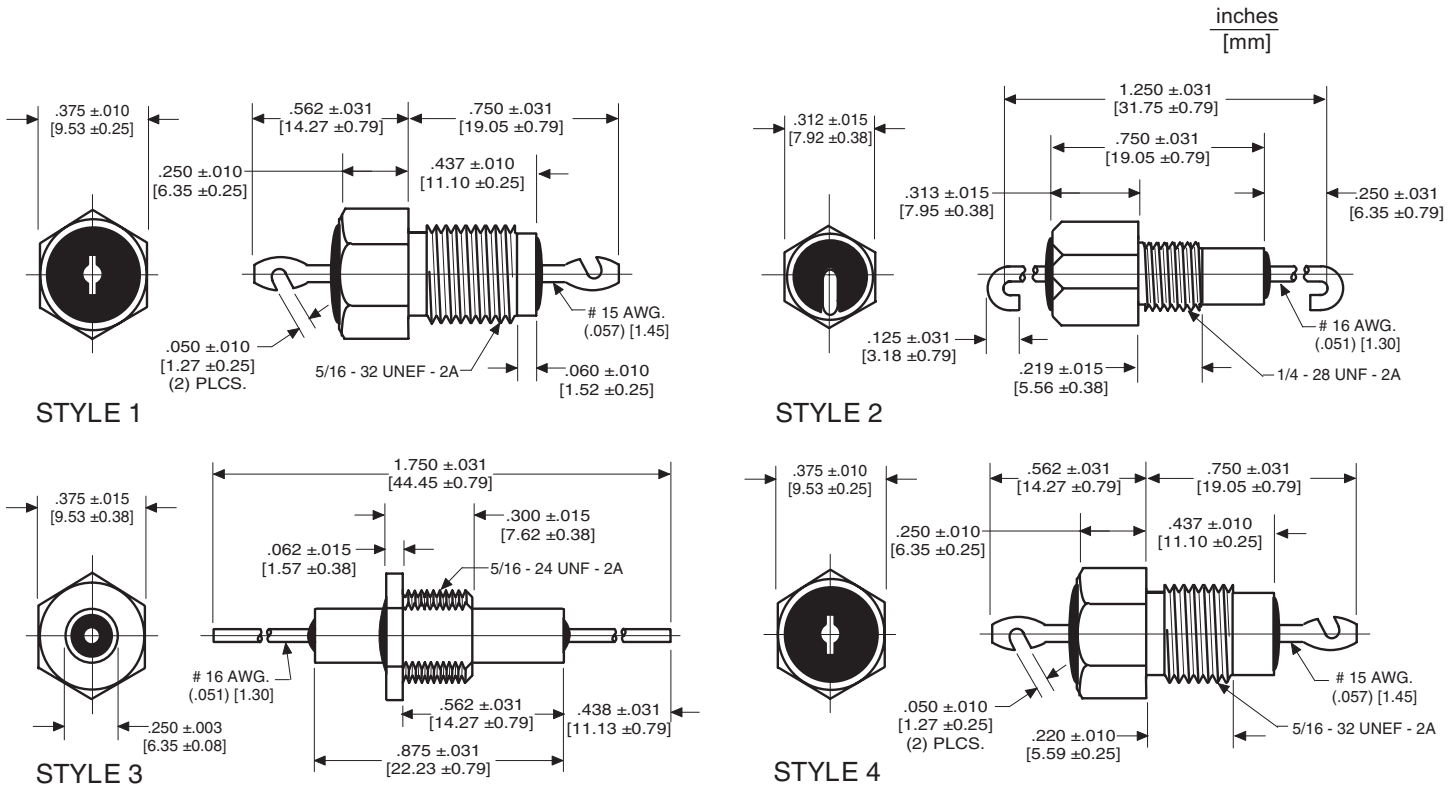

| TUSONIX Part Number | Temperature Range | WVDC | MAX. CAP. (Nominal) (pF) |
|---------------------|-------------------|------|--------------------------|
| 327 | Z5, Y5, X5 | 500 | 10,000 |
| | X7 | 250 | 10,000 |
| 2432 | Z5, Y5, X5 | 2000 | 7,000 |
| | X7 | 1000 | 7,000 |

| Notes: |
|---------------------------|
| ▽ 5/16-24 UNF-2A Thread |
| •• Typical Insertion Loss |

Please see Temperature Characteristics and EIA Codes on page 25.

| TUSONIX Part Number | MIL-PRF-15733 Number | Style | Notes | Circuit | Working Voltage (dc) | | Capacitance (pF) | Capacitance Tolerance | Current (A) | Minimum No-Load Insertion Loss (dB) at 25°C per MIL-Std-220 | | | |
|-------------------------|----------------------|-------|-------|---------|----------------------|----------------|------------------|-----------------------|-------------|---|--------|------|-------|
| | | | | | 85°C | 125°C | | | | 10MHz | 100MHz | 1GHz | 10GHz |
| C Configuration | | | | | | | | | | | | | |
| 327-010-X5U0-102M | -- | 2 | •• | C | 500 | 250 | 1000 | ±20% | 20 | 3 | 20 | 35 | 40 |
| 327-010-X5U0-152M | -- | 2 | •• | C | 500 | 250 | 1500 | ±20% | 20 | 5 | 22 | 35 | 40 |
| 327-010-X5U0-502P | -- | 2 | •• | C | 500 | 250 | 5000 | +100-0% | 20 | 15 | 30 | 45 | 50 |
| 327-010-X7W0-103Z | -- | 2 | •• | C | 500 | 250 | 10,000 | +80-20% | 20 | 20 | 35 | 50 | 55 |
| C Configuration | | | | | | | | | | | | | |
| 2432-002-X5R0-101M | -- | 3 | •• | C | 2000 | 1000 | 100 | ±20% | 20 | -- | 3 | 20 | 27 |
| 2432-002-X5S0-471M | -- | 3 | •• | C | 2000 | 1000 | 470 | ±20% | 20 | -- | 12 | 27 | 27 |
| 2432-002-X5U0-502M | -- | 3 | •• | C | 2000 | 1000 | 5000 | ±20% | 20 | 15 | 30 | 45 | 50 |
| 2432-002-X5W0-752Z | -- | 3 | •• | C | 2000 | 1000 | 7500 | +80-20% | 20 | 15 | 30 | 45 | 50 |
| 2432-002-X7R0-102M | -- | 3 | •• | C | 2000 | 1000 | 1000 | ±20% | 20 | 3 | 20 | 35 | 40 |
| Pi Configuration | | | | | | | | | | | | | |
| 4206-016 | -- | 1 | -- | Pi | 1000 | -- | 1000 | GMV | 25 | 3 | 35 | 65 | 65 |
| 4206-501 | /61-0004 | 4 | -- | Pi | -- | 500dc 350ac | 2000 | GMV | 25ac | -- | 55 | 70 | 70 |
| 4206-502 | /61-0003 | 4 | ▽ | Pi | -- | 500dc 350ac | 2000 | GMV | 25ac | -- | 55 | 70 | 70 |
| 4206-006 | -- | 1 | -- | Pi | 1000 | 500 | 3000 | GMV | 25 | 10 | 55 | 70 | 70 |

Drawings not to scale.

Please note: All bushing style filters include hex nut and lock washer unless otherwise specified.

Metric Bushing Filters

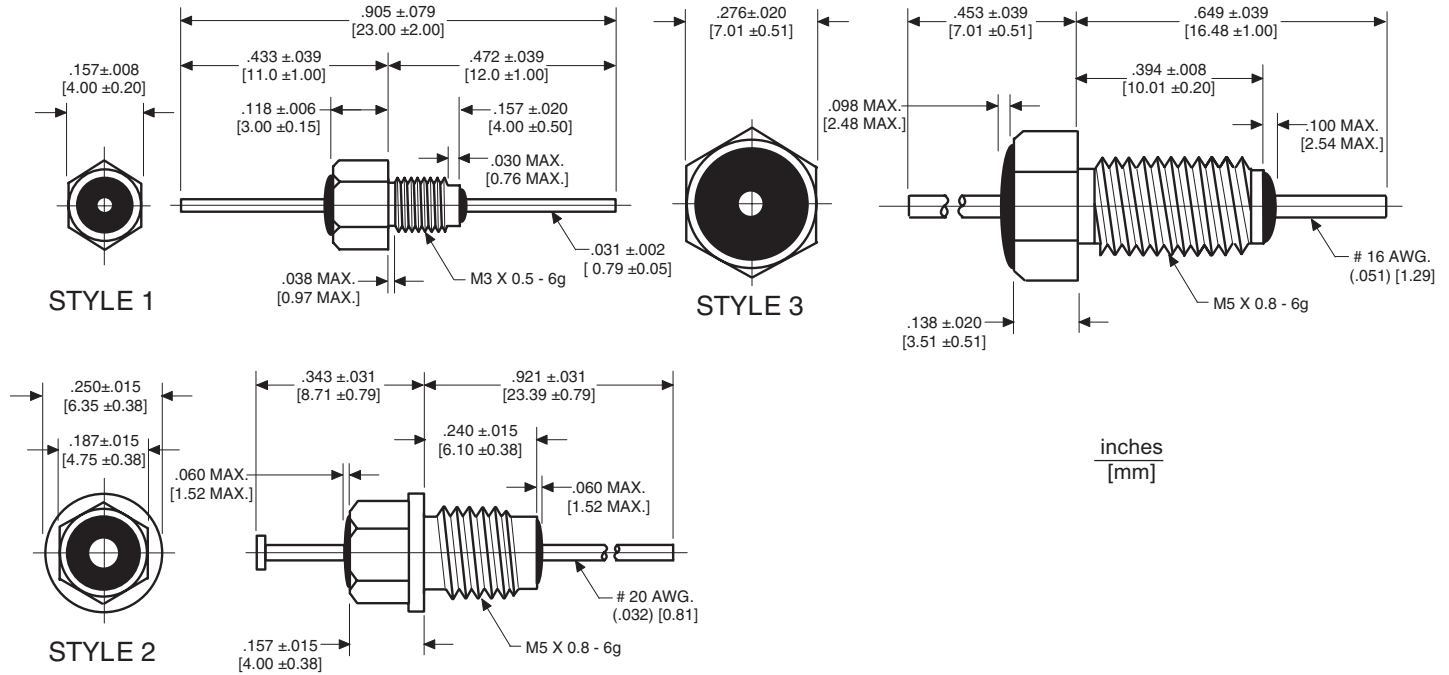

| Series Number | Temperature Range | WVdc | MAX. CAP. Nominal (pF) |
|---------------|-------------------|------|------------------------|
| 2499 | Z5, Y5, X5 | 500 | 5000 |
| | X7 | 250 | 5000 |

| Notes: |
|---------------------------|
| •• Typical Insertion Loss |

Please see Temperature Characteristics and EIA Codes on page 25.

| TUSONIX Part Number | Style | Notes | Circuit | Working Voltage (dc) | | Capacitance (pF) | Capacitance Tolerance | Current (A) | Minimum No-Load Insertion Loss (dB) at 25°C per MIL-Std-220 | | | | |
|---------------------|-------|-------|---------|----------------------|-------|------------------|-----------------------|-------------|---|-------|--------|------|-------|
| | | | | 85°C | 125°C | | | | 1MHz | 10MHz | 100MHz | 1GHz | 10GHz |
| M3 Thread | | | | | | | | | | | | | |
| 4400-093 | 1 | -- | C | 70 | 50 | 10,000 | +80-20% | 10 | 4 | 20 | 35 | 50 | 50 |
| 4400-098 | 1 | -- | C | 70 | 50 | 27,000 | GMV | 10 | 10 | 28 | 42 | 55 | 60 |
| 4400-099 | 1 | -- | C | 50 | 50 | 50,000 | GMV | 10 | 15 | 35 | 45 | 70 | -- |
| 4400-094 | 1 | -- | C | 150 | 100 | 4700 | GMV | 10 | -- | 15 | 30 | 45 | 55 |
| 4400-095 | 1 | -- | C | 300 | 200 | 1000 | GMV | 10 | -- | 5 | 20 | 35 | 45 |
| 4400-683 | 1 | -- | C | 300 | 200 | 5 | MAX | 10 | -- | -- | -- | -- | -- |
| 4400-076 | 1 | -- | C | 300 | 200 | 100 | GMV | 10 | -- | -- | 3 | 20 | 28 |
| 4400-096 | 1 | -- | C | 300 | 200 | 470 | GMV | 10 | -- | -- | 15 | 35 | 40 |
| 4400-097 | 1 | -- | C | 150 | 100 | 2700 | GMV | 10 | -- | 10 | 25 | 40 | 50 |
| M5 Thread | | | | | | | | | | | | | |
| 4209-053 | 2 | -- | Pi | 350 | 100 | 5500 | GMV | 10 | -- | 20 | 65 | 70 | 70 |
| 4209-003 | 2 | -- | Pi | 350 | 200 | 1500 | GMV | 10 | -- | 5 | 45 | 70 | 70 |
| 2499-523-Y5R0-102P | 3 | •• | C | 500 | 250 | 1000 | +100-0% | 20 | -- | 3 | 20 | 35 | 40 |

Drawings not to scale.

Please note: All bushing style filters include hex nut and lock washer unless otherwise specified.

The products listed in this catalog are only a few of the thousands of variations that TUSONIX produces. For custom component design, please contact the factory direct.



Coaxial Broadband Filter 1/4-28 UNF-2A

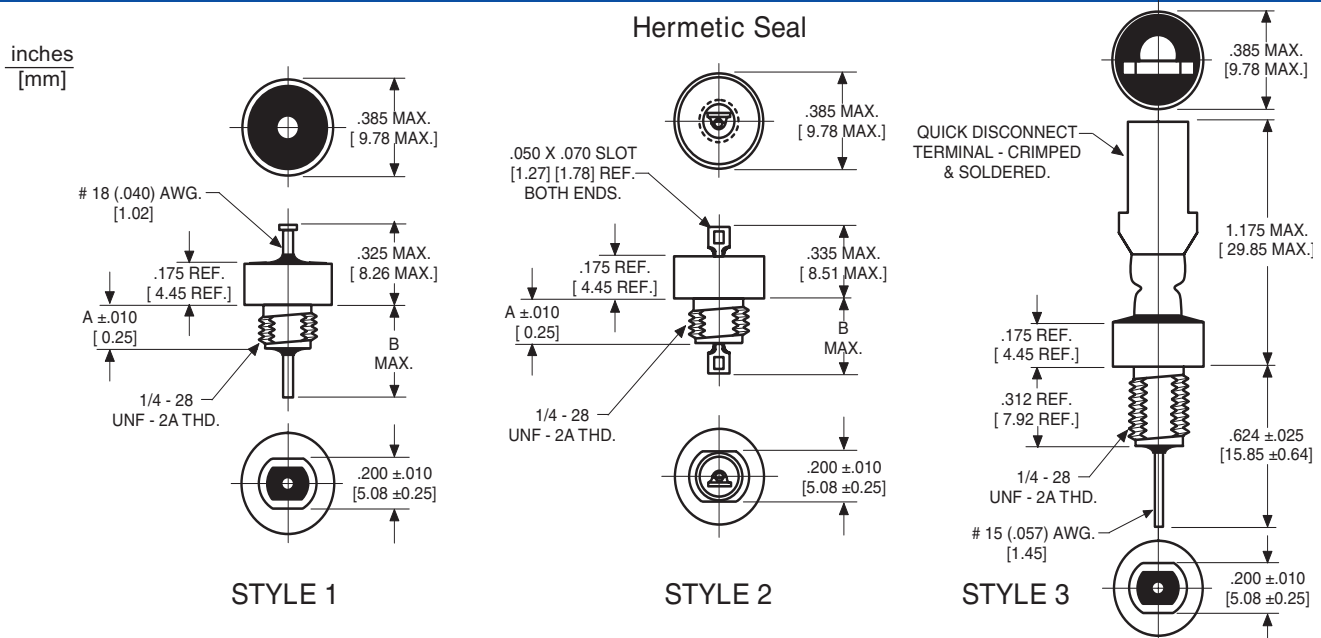

| TUSONIX Part Number | Style | Dim. A inch [mm] | Dim. B inch [mm] | Circuit | Working Voltage (dc) | | Capacitance (pF) | Current (A) | Minimum No-Load Insertion Loss (dB) at 25°C per MIL-Std-220 | | | | | | | | | |
|---------------------------------------|-------|------------------|------------------|---------|----------------------|-------|------------------|-------------|---|--------|--------|------|-------|------|----|--|--|--|
| | | | | | 85°C | 125°C | | | 30KHz | 100KHz | 300KHz | 1MHz | 10MHz | 1GHz | | | | |
| X7W Temperature Characteristic | | | | | | | | | | | | | | | | | | |
| 4601-009 | 2 | .187 [4.75] | .350 [8.89] | C | 100 | 70 | 10pF Max | 15 | -- | -- | -- | -- | -- | -- | -- | | | |
| 4600-005 | 1 | .187 [4.75] | .367 [9.32] | C | 100 | 70 | 0.7 μF | 15 | 9 | 20 | 29 | 39 | 52 | 70 | | | | |
| 4600-006 | 1 | .312 [7.93] | .492 [12.50] | C | 100 | 70 | 0.7 μF | 15 | 9 | 20 | 29 | 39 | 52 | 70 | | | | |
| 4601-005 | 2 | .187 [4.75] | .350 [8.89] | C | 100 | 70 | 0.7 μF | 15 | 9 | 20 | 29 | 39 | 52 | 70 | | | | |
| 4601-006 | 2 | .312 [7.93] | .475 [12.07] | C | 100 | 70 | 0.7 μF | 15 | 9 | 20 | 29 | 39 | 52 | 70 | | | | |
| 4600-000 | 1 | .187 [4.75] | .367 [9.32] | C | 100 | 70 | 1.4 μF | 15 | 15 | 25 | 34 | 44 | 60 | 70 | | | | |
| 4600-002 | 1 | .312 [7.93] | .492 [12.50] | C | 100 | 70 | 1.4 μF | 15 | 15 | 25 | 34 | 44 | 60 | 70 | | | | |
| 4601-000 | 2 | .187 [4.75] | .350 [8.89] | C | 100 | 70 | 1.4 μF | 15 | 15 | 25 | 34 | 44 | 60 | 70 | | | | |
| 4601-002 | 2 | .312 [7.93] | .475 [12.07] | C | 100 | 70 | 1.4 μF | 15 | 15 | 25 | 34 | 44 | 60 | 70 | | | | |
| 4600-055 | 1 | .187 [4.75] | .367 [9.32] | L | 100 | 70 | 0.7 μF | 15 | 9 | 20 | 29 | 39 | 52 | 70 | | | | |
| 4600-056 | 1 | .312 [7.93] | .492 [12.50] | L | 100 | 70 | 0.7 μF | 15 | 9 | 20 | 29 | 39 | 52 | 70 | | | | |
| 4601-055 | 2 | .187 [4.75] | .350 [8.89] | L | 100 | 70 | 0.7 μF | 15 | 9 | 20 | 29 | 39 | 52 | 70 | | | | |
| 4601-056 | 2 | .312 [7.93] | .475 [12.07] | L | 100 | 70 | 0.7 μF | 15 | 9 | 20 | 29 | 39 | 52 | 70 | | | | |
| 4600-050 | 1 | .187 [4.75] | .367 [9.32] | L | 100 | 70 | 1.4 μF | 15 | 15 | 25 | 34 | 44 | 60 | 70 | | | | |
| 4600-052 | 1 | .312 [7.93] | .492 [12.50] | L | 100 | 70 | 1.4 μF | 15 | 15 | 25 | 34 | 44 | 60 | 70 | | | | |
| 4601-050 | 2 | .187 [4.75] | .350 [8.89] | L | 100 | 70 | 1.4 μF | 15 | 15 | 25 | 34 | 44 | 60 | 70 | | | | |
| 4601-052 | 2 | .312 [7.93] | .475 [12.07] | L | 100 | 70 | 1.4 μF | 15 | 15 | 25 | 34 | 44 | 60 | 70 | | | | |
| X7R Temperature Characteristic | | | | | | | | | | | | | | | | | | |
| 4600-007 | 1 | .187 [4.75] | .367 [9.32] | C | 100 | 70 | 0.7 μF | 15 | 9 | 20 | 29 | 39 | 52 | 70 | | | | |
| 4600-008 | 1 | .312 [7.93] | .492 [12.50] | C | 100 | 70 | 0.7 μF | 15 | 9 | 20 | 29 | 39 | 52 | 70 | | | | |
| 4601-007 | 2 | .187 [4.75] | .350 [8.89] | C | 100 | 70 | 0.7 μF | 15 | 9 | 20 | 29 | 39 | 52 | 70 | | | | |
| 4601-008 | 2 | .312 [7.93] | .475 [12.07] | C | 100 | 70 | 0.7 μF | 15 | 9 | 20 | 29 | 39 | 52 | 70 | | | | |
| 4600-003 | 1 | .187 [4.75] | .367 [9.32] | C | 100 | 50 | 1.4 μF | 15 | 15 | 25 | 34 | 44 | 60 | 70 | | | | |
| 4600-004 | 1 | .312 [7.93] | .492 [12.50] | C | 100 | 70 | 1.4 μF | 15 | 15 | 25 | 34 | 44 | 60 | 70 | | | | |
| 4601-003 | 2 | .187 [4.75] | .350 [8.89] | C | 100 | 50 | 1.4 μF | 15 | 15 | 25 | 34 | 44 | 60 | 70 | | | | |
| 4601-004 | 2 | .312 [7.93] | .475 [12.07] | C | 100 | 50 | 1.4 μF | 15 | 15 | 25 | 34 | 44 | 60 | 70 | | | | |
| 4600-009 | 1 | .187 [4.75] | .367 [9.32] | C | 280 | | .15 μF | 15 | -- | 7 | 15 | 25 | 40 | 60 | | | | |
| 4601-010 | 2 | .187 [4.75] | .350 [8.89] | C | 280 | | .15 μF | 15 | -- | 7 | 15 | 25 | 40 | 60 | | | | |
| 4600-057 | 1 | .187 [4.75] | .367 [9.32] | L | 100 | 70 | 0.7 μF | 15 | 9 | 20 | 29 | 39 | 52 | 70 | | | | |
| 4600-058 | 1 | .312 [7.93] | .492 [12.50] | L | 100 | 70 | 0.7 μF | 15 | 9 | 20 | 29 | 39 | 52 | 70 | | | | |
| 4601-057 | 2 | .187 [4.75] | .350 [8.89] | L | 100 | 70 | 0.7 μF | 15 | 9 | 20 | 29 | 39 | 52 | 70 | | | | |
| 4601-058 | 2 | .312 [7.93] | .475 [12.07] | L | 100 | 70 | 0.7 μF | 15 | 9 | 20 | 29 | 39 | 52 | 70 | | | | |
| 4600-053 | 1 | .187 [4.75] | .367 [9.32] | L | 100 | 50 | 1.4 μF | 15 | 15 | 25 | 34 | 44 | 60 | 70 | | | | |
| 4600-054 | 1 | .312 [7.93] | .492 [12.50] | L | 100 | 50 | 1.4 μF | 15 | 15 | 25 | 34 | 44 | 60 | 70 | | | | |
| 4601-053 | 2 | .187 [4.75] | .350 [8.89] | L | 100 | 50 | 1.4 μF | 15 | 15 | 25 | 34 | 44 | 60 | 70 | | | | |
| 4601-054 | 2 | .312 [7.93] | .475 [12.07] | L | 100 | 50 | 1.4 μF | 15 | 15 | 25 | 34 | 44 | 60 | 70 | | | | |
| 4600-059 | 1 | .187 [4.75] | .367 [9.32] | L | 280 | | .15 μF | 15 | -- | 7 | 15 | 25 | 40 | 60 | | | | |
| 4601-059 | 2 | .187 [4.75] | .350 [8.89] | L | 280 | | .15 μF | 15 | -- | 7 | 15 | 25 | 40 | 60 | | | | |

Coaxial Broadband Filter 1/4-28 UNF-2A and Standard Hardware Dimensions

Notes:
 ▲ 12 AWG .081[2.06] Lead and X7R Temp. Characteristic

| TUSONIX Part Number | Style | Notes | Dim. A inch [mm] | Dim. B inch [mm] | Circuit | Working Voltage (dc) | | Capacitance (pF) | Current (A) | Minimum No-Load Insertion Loss (dB) at 25°C per MIL-Std-220 | | | | | | | | |
|---------------------------------------|-------|-------|------------------|------------------|---------|----------------------|----------------|------------------|-------------|---|--------|--------|------|-------|------|--|--|--|
| | | | | | | 85°C | 125°C | | | 30KHz | 100KHz | 300KHz | 1MHz | 10MHz | 1GHz | | | |
| X7R Temperature Characteristic | | | | | | | | | | | | | | | | | | |
| 4600-014 | 3 | -- | -- | -- | C | 100 | 70 | 0.7 μF | 20 | 9 | 20 | 29 | 39 | 52 | 70 | | | |
| 4600-015 | 3 | -- | -- | -- | C | 100 | 50 | 1.4 μF | 20 | 15 | 25 | 34 | 44 | 60 | 70 | | | |
| 4600-016 | 3 | -- | -- | -- | C | 280 | 200dc 125ac | .15 μF | 20 | -- | 7 | 15 | 25 | 40 | 60 | | | |
| 4600-070 | 3 | -- | -- | -- | L | 100 | 70 | 0.7 μF | 20 | 9 | 20 | 29 | 39 | 40 | 70 | | | |
| 4600-067 | 3 | ▲ | -- | -- | L | 100 | 70 | 1.2 μF | 30 | 15 | 25 | 34 | 44 | 52 | 70 | | | |
| 4600-071 | 3 | -- | -- | -- | L | 100 | 50 | 1.4 μF | 20 | 15 | 25 | 34 | 44 | 60 | 70 | | | |
| 4600-072 | 3 | -- | -- | -- | L | 280 | 200dc 125ac | .15 μF | 20 | -- | 7 | 15 | 25 | 60 | 60 | | | |

STANDARD HARDWARE DIMENSIONS

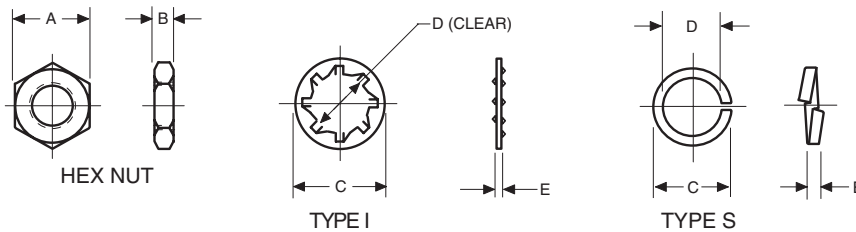

| NUT THREAD SIZE | MOUNTING TORQUE LIMITS | HEX NUT | | TYPE | LOCK WASHER | | |
|-----------------|------------------------|------------------------------|------------------------------|------|--------------|-------------|-------------|
| | | A | B | | C | D | E |
| 4-40 UNC | 2 lb.in. [.226 N-m] | .187 [4.75] | .062 [1.57] | I | .220 [5.59] | .120 [3.05] | .015 [0.38] |
| 6-32 UNC | 2 lb.in. [.226 N-m] | .187 [4.75] | .062 [1.57] | I | .283 [7.19] | .146 [3.71] | .017 [0.43] |
| 6-40 UNF | 3 lb.in. [.339 N-m] | .187 [4.75] | .062 [1.57] | I | .283 [7.19] | .146 [3.71] | .017 [0.43] |
| 8-32 UNC | 5 lb.in. [.565 N-m] | .250 [6.35] | .075 [1.91] | I | .283 [7.19] | .167 [4.24] | .018 [0.46] |
| 8-36 UNF | 1 lb.in. [.113 N-m] | -- | -- | I | .283 [7.19] | .167 [4.24] | .015 [0.38] |
| 12-28 UNF | 8 lb.in. [.904 N-m] | .250 [6.35] .250 [6.35] | .075 [1.91] .100 [2.54] | I | .387 [9.83] | .220 [5.59] | .022 [0.56] |
| 12-32 UNEF | 8 lb.in. [.904 N-m] | .250 [6.35] | .075 [1.91] | I | .387 [9.83] | .220 [5.59] | .022 [0.56] |
| 1/4-28 UNF | 8 lb.in. [.904 N-m] | .313 ± .015 [7.95 ± 0.38] | .125 ± .015 [3.18 ± 0.38] | I | .387 [9.83] | .220 [5.59] | .022 [0.56] |
| 5/16-24 UNF | 9 lb.in. [1.02 N-m] | .375 ± .010 [9.53 ± 0.25] | .090 [2.29] | I | .420 [10.6] | .262 [6.65] | .025 [0.63] |
| 5/16-32 UNEF | 9 lb.in. [1.02 N-m] | .375 ± .010 [9.53 ± 0.25] | .090 [2.29] | I | .430 [10.92] | .318 [8.08] | .022 [0.56] |
| 3/8-32 UNEF | 9 lb.in. [1.02 N-m] | .500 ± .010 [12.7 ± 0.25] | .090 [2.29] | I | .430 [10.92] | .318 [8.08] | .022 [0.56] |
| M3 X 0.5 | 2 lb.in. [.226 N-m] | .187 ± .010 [4.75 ± 0.25] | .062 [1.57] | I | .500 [12.70] | .384 [9.75] | .022 [0.56] |
| M5 X 0.8 6g | 7 lb.in. [.790 N-m] | .250 [6.35] | .075 [1.91] | S | .192 [4.88] | .118 [2.99] | .025 [0.63] |
| | | | | S | .277 [7.04] | .172 [4.37] | .034 [0.86] |
| | | | | S | .361 [9.17] | .225 [5.72] | .050 [1.27] |

Characteristics

- Dimensions: Inches [metric]
Dimensional Tolerance: ± .005 [0.13], thread tolerance class 2.
- Standard finish: Silver
- Nut material: Brass
Washer material: Phosphor Bronze
- When mounting filter without hardware, into tapped hole, the mounting torque applied to the filter body must be no more than 1/2 the torque limits listed on the chart to the left.

The products listed in this catalog are only a few of the thousands of variations that TUSONIX produces. For custom component design, please contact the factory direct.



Product Installation Recommendations and EIA codes

PRODUCT INSTALLATION RECOMMENDATIONS

The components in this catalog are manufactured with ceramic dielectrics. To minimize possible damage to the components during installation, the recommendations below should be followed. For information concerning other installation requirements and/or component modifications, consult TUSONIX Customer Engineering at (520) 744-0400.

General Recommendations

- Handling:** Excessive force or direct impact to the component may result in breakage. Lead bending or cutting, if necessary, should be done with a support for the lead to prevent mechanical stress to the component. Components with required lead modifications are available from TUSONIX.
- Lead Soldering:** Use a temperature controlled soldering iron with SN60 or SN63 RMA Flux core wire. Maximum soldering temperature to be 500°F(260°C) with a dwell time of 3 seconds maximum. The use of a heat sink between the component body and the solder joint is highly recommended.
- Flux Removal:** Optimum flux removal can be achieved by vapor degreasing the components immediately after the soldering operation. Total immersion of the components is not recommended.

Solder Mount Recommendations

- Mounting:** Use a convection or infrared oven and SN60 or SN63 solder paste, or solder preforms, with RMA Flux. The oven profile should slowly heat the entire assembly to a reflow temperature of 430°F (221°C), with a rate of change not to exceed 5°F,3°C/Sec. and a dwell time as short as possible.
- Internal Electrode Soldering:** Use a temperature controlled soldering iron with SN62 silver bearing (2%) RMA Flux core solder wire. The components should be preheated to 300°F (150°C), then soldered with a maximum temperature of 500°F (260°C) and a dwell of 3 seconds maximum.

Bushing Mount Recommendations

For Mounting Torque, please see standard hardware dimensions table on page 24.

EIA/Tusonix Tolerance Codes

| TEMPERATURE CHARACTERISTICS | |
|-----------------------------|---------------------|
| EIA Code | Temperature Range |
| Z5 | +10°C to +85°C |
| Y5 | -30°C to +85°C |
| X5 | -55°C to +85°C |
| X7 | -55°C to +125°C |
| EIA Code | Maximum Cap. Change |
| D | ± 3.3% |
| E | ± 4.7% |
| F | ± 7.5% |
| P | ± 10% |
| R | ± 15% |
| S | ± 22% |
| T | + 22% -33% |
| U | + 22% -56% |
| V | + 22% -82% |
| W | + 22% -90% |

| CAPACITANCE TOLERANCE | | |
|--|------|----------------------------------|
| Nominal Capacitnce 10 pF or Less | Code | Nominal Capacitnce over 10 pF |
| GMV◆ | AA | GMV◆ |
| ± 0.1 pF | A | +50% -20% |
| ± 0.25 pF | B | ± 0.10% |
| ± 0.5 pF | C | ± 0.25% |
| ± 0.3 pF | D | ± 0.50% |
| ± 1 pF | E | +70% -30% |
| ± 2 pF | F | ± 1% |
| ± 3% | G | ± 2% |
| | H | ± 3% |
| | I | +60% -40% |
| ± 5% | J | ± 5% |
| ± 10% | K | ± 10% |
| ± 2% | L | +100% -40% |

| CAPACITANCE TOLERANCE (Cont.) | | |
|--|------|----------------------------------|
| Nominal Capacitnce 10 pF or Less | Code | Nominal Capacitnce over 10 pF |
| ± 20% | M | ± 20% |
| ± 0.4 pF | N | ± 30% |
| ± 0.2 pF | P | +100% -0% |
| | Q | ± 15% |
| | R | ± 2.5% |
| | S | +50% -15% |
| | T | +30% -20% |
| | U | +80% -0% |
| | V | ± 7% |
| | W | +50% -30% |
| MAX. | X | +40% -10% |
| | Y | +50% -0% |
| | Z | +80% -20% |

◆GMV: TUSONIX Code: Guaranteed Minimum Value

Please note: Maximum Capacitance for each part number is determined by the required operating temperature range and maximum capacitance change.

General Test Specifications

The Components shown in this catalog have been designed and subjected to the following test plan, as is applicable for the individual components. The information shown can be used as a basis for component specifications. For additional information, please consult Customer Engineering at (520) 744-0400.

Filters governed by MIL-PRF-15733 shall be inspected and tested to the requirements of the specification and the applicable specification (slash) sheet.

| LOT ACCEPTANCE INSPECTION: | | |
|---|--|---|
| INSPECTION OR TEST | TEST METHOD PER MIL-STD-202 EXCEPT AS NOTED | POST TEST REQUIREMENTS |
| Visual and Mechanical | | In accordance with applicable requirements |
| Materials, Design, Construction and Workmanship | | |
| Physical Dimensions & Marking | | |
| Seal (4601 Style Only) | Method 112, condition A | No leaks |
| Capacitance | Method 305, 1KHz, 1±0.2 VRMS max. +25°C | Within specified tolerance |
| Dissipation Factor (1/Q) | Method 306, 1KHz, 1±0.2 VRMS max. +25°C | 4.0% max |
| Dielectric Withstanding Voltage | Method 301, 2 seconds, 50 mA max. surge current, 2 times WVDC. | No evidence of damage or break down. |
| Insulation Resistance | Method 302, 50 mA max. charging current, 100VDC, 2 minutes or as specified by individual variation | Greater than 10,000 Megohms or 100 Ohm-Farads, whichever is less. |
| Insertion Loss | MIL-STD-220, 50 Ohms, +25°C, no load | Per application requirements. |
| DC Resistance (4601 Style Only) | MIL-PRF-15733 | 0.01 Ohms max. |
| Solderability (5pcs) | Method 208 | Per applicable requirements. |

PERIODIC QUALITY CONFORMANCE INSPECTION:

A periodic quality conformance inspection program consisting of environmental and reliability testing is in place to ensure that product integrity is consistently maintained.

TUSONIX on-line www.tusonix.com

The TUSONIX Web site provides visitors with a wide range of product and ordering information. At www.tusonix.com, customers can view product information and download catalogs in Adobe Acrobat® .pdf format. Customers can also view or link to Sales Offices, International Agents and Distributors. An on-line request form allows customers to immediately specify product requirements and request product information.

Компания «Life Electronics» занимается поставками электронных компонентов импортного и отечественного производства от производителей и со складов крупных дистрибьюторов Европы, Америки и Азии.

С конца 2013 года компания активно расширяет линейку поставок компонентов по направлению коаксиальный кабель, кварцевые генераторы и конденсаторы (керамические, пленочные, электролитические), за счёт заключения дистрибьюторских договоров

Мы предлагаем:

- Конкуренеспособные цены и скидки постоянным клиентам.
- Специальные условия для постоянных клиентов.
- Подбор аналогов.
- Поставку компонентов в любых объемах, удовлетворяющих вашим потребностям.
- Приемлемые сроки поставки, возможна ускоренная поставка.
- Доставку товара в любую точку России и стран СНГ.
- Комплексную поставку.
- Работу по проектам и поставку образцов.
- Формирование склада под заказчика.
- Сертификаты соответствия на поставляемую продукцию (по желанию клиента).
- Тестирование поставляемой продукции.
- Поставку компонентов, требующих военную и космическую приемку.
- Входной контроль качества.
- Наличие сертификата ISO.

В составе нашей компании организован Конструкторский отдел, призванный помогать разработчикам, и инженерам.

Конструкторский отдел помогает осуществить:

- Регистрацию проекта у производителя компонентов.
- Техническую поддержку проекта.
- Защиту от снятия компонента с производства.
- Оценку стоимости проекта по компонентам.
- Изготовление тестовой платы монтаж и пусконаладочные работы.



Тел: +7 (812) 336 43 04 (многоканальный)

Email: org@lifeelectronics.ru