

Ultrabright White LED, Ø 3 mm

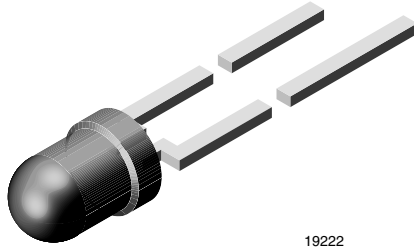

19222

DESCRIPTION

The VLHW4100 is a clear, untinted 3 mm LED for high end applications where supreme luminous intensity is required.

These lamps utilize the highly developed ultrabright InGaN technologies.

The lens and the viewing angle is optimized to achieve best performance of light output and visibility.

PRODUCT GROUP AND PACKAGE DATA

- Product group: LED
- Package: 3 mm
- Product series: standard
- Angle of half intensity: $\pm 22.5^\circ$

FEATURES

- Clear, untinted lens
- Utilizing ultrabright InGaN technology
- High luminous intensity
- Luminous intensity and color categorized for each packing unit
- ESD-withstand voltage: up to 2 kV according to JESD22-A114-B
- Compliant to RoHS Directive 2002/95/EC

RoHS
COMPLIANT

APPLICATIONS

- Interior and exterior lighting
- Outdoor LED panels
- Instrumentation and front panel indicators
- Replaces incandescent lamps
- Light guide compatible

PARTS TABLE

PART	COLOR, LUMINOUS INTENSITY	TECHNOLOGY
VLHW4100	White, $I_V = (4500 \text{ to } 11\,250) \text{ mcd}$	InGaN and converter

ABSOLUTE MAXIMUM RATINGS VLHW4100 ($T_{\text{amb}} = 25^\circ\text{C}$, unless otherwise specified)

PARAMETER	TEST CONDITION	SYMBOL	VALUE	UNIT
Reverse voltage		V_R	5	V
DC forward current		I_F	25	mA
Peak forward current	at 1 kHz, $t_p/T = 0.1$	I_{FSM}	0.1	A
Power dissipation		P_V	95	mW
Junction temperature		T_j	120	$^\circ\text{C}$
Operating temperature range		T_{amb}	- 40 to + 85	$^\circ\text{C}$
Storage temperature range		T_{stg}	- 40 to + 85	$^\circ\text{C}$
Soldering temperature	$t \leq 5 \text{ s}$	T_{sd}	260	$^\circ\text{C}$
Thermal resistance junction/ambient		R_{thJA}	400	K/W

OPTICAL AND ELECTRICAL CHARACTERISTICS ($T_{amb} = 25\text{ }^{\circ}\text{C}$, unless otherwise specified)
WHITE VLHW4100

PARAMETER	TEST CONDITION	PART	SYMBOL	MIN.	TYP.	MAX.	UNIT
Luminous intensity	$I_F = 20\text{ mA}$	VLHW4100	I_V	4500	7150	11 250	mcd
Chromaticity coordinate x acc. to CIE 1931	$I_F = 20\text{ mA}$		x		0.33		
Chromaticity coordinate y acc. to CIE 1931	$I_F = 20\text{ mA}$		y		0.33		
Angle of half intensity	$I_F = 20\text{ mA}$		ϕ		± 22.5		deg
Forward voltage	$I_F = 20\text{ mA}$		V_F	2.8	3.2	3.8	V
Reverse current	$V_R = 5\text{ V}$		I_R			50	μA
Temperature coefficient of V_F	$I_F = 20\text{ mA}$		TC_{VF}		- 4		mV/K
Temperature coefficient of I_V	$I_F = 20\text{ mA}$		TC_{IV}		- 0.5		% / K

CHROMATICITY COORDINATED CLASSIFICATION

	X	Y		X	Y
YU	0.274	0.301	WL	0.317	0.325
	0.283	0.284		0.319	0.310
	0.307	0.316		0.329	0.319
	0.303	0.333		0.329	0.336
YL	0.283	0.284	VU	0.329	0.354
	0.290	0.270		0.329	0.336
	0.310	0.299		0.345	0.350
	0.307	0.316		0.347	0.368
XU	0.303	0.333	VL	0.329	0.336
	0.307	0.316		0.329	0.319
	0.317	0.325		0.343	0.331
	0.315	0.343		0.345	0.350
XL	0.307	0.316	UU	0.347	0.368
	0.310	0.299		0.345	0.350
	0.319	0.310		0.361	0.365
	0.317	0.325		0.364	0.383
WU	0.315	0.343	UL	0.345	0.350
	0.317	0.325		0.343	0.331
	0.329	0.336		0.357	0.343
	0.329	0.354		0.361	0.365

Note:

Chromaticity coordinate groups are tested at a current pulse duration of 25 ms and a tolerance of ± 0.01 .

LUMINOUS INTENSITY CLASSIFICATION

GROUP	LIGHT INTENSITY (mcd)	
	MIN.	MAX.
Z1	4500	5600
Z2	5600	7150
AA	7150	9000
AB	9000	11 250

Note:

Luminous intensity is tested with an accuracy of $\pm 15\%$.

The above type Numbers represent the order groups which include only a few brightness groups. Only one group will be shipped on each reel (there will be no mixing of two groups on each reel). In order to ensure availability, single brightness groups will not be orderable.

In a similar manner for colors where color groups are measured and binned, single color groups will be shipped on any one reel.

In order to ensure availability, single color groups will not be orderable.

TYPICAL CHARACTERISTICS ($T_{amb} = 25\text{ }^{\circ}\text{C}$, unless otherwise specified)

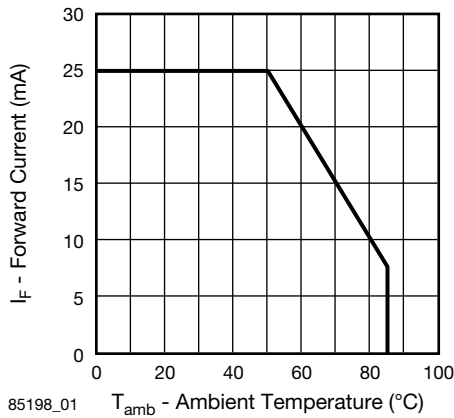

Figure 1. Forward Current vs. Ambient Temperature

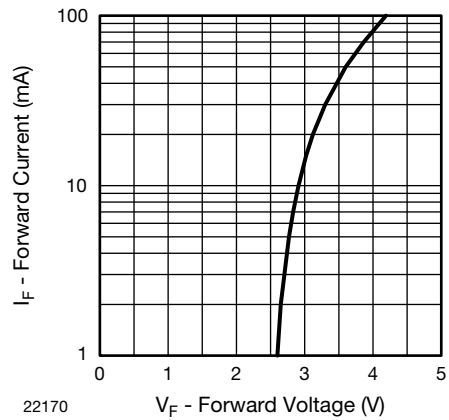

Figure 4. Forward Current vs. Forward Voltage

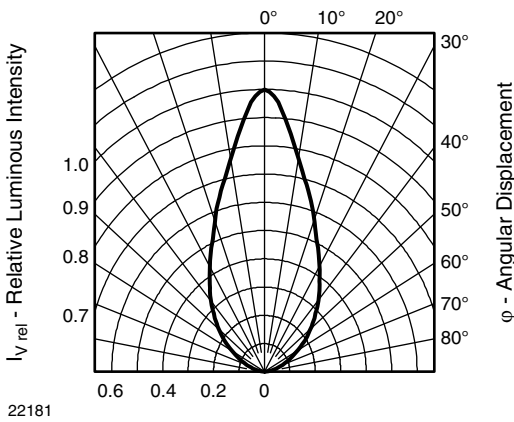

Figure 2. Relative Luminous Intensity vs. Angular Displacement

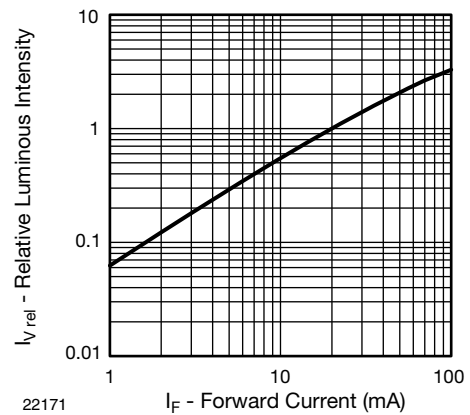

Figure 5. Relative Luminous Flux vs. Forward Current

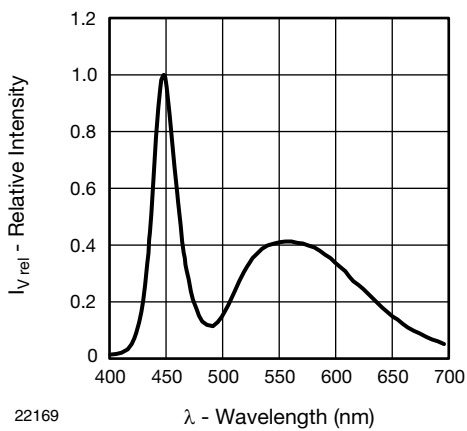

Figure 3. Relative Intensity vs. Wavelength

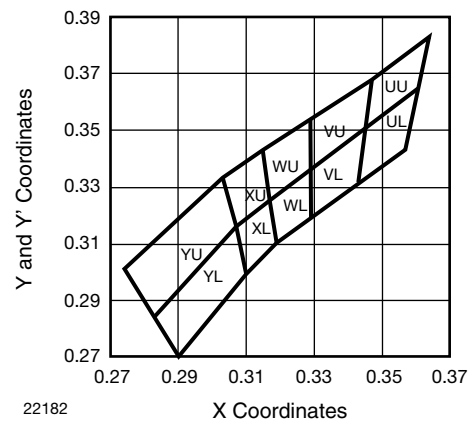
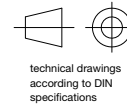
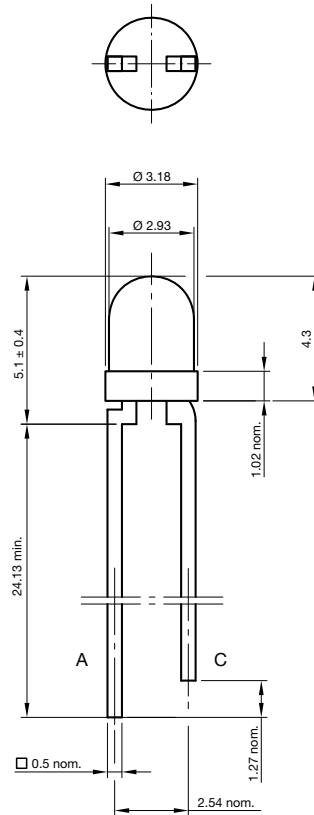

Figure 6. Coordinates of Colorgroups

PACKAGE DIMENSIONS in millimeters



Not indicated tolerances ± 0.25

Drawing-No.: 6.544-5403.01-4
 Issue: 2; 18.06.10
 21948

BAR CODE PRODUCT LABEL (example)

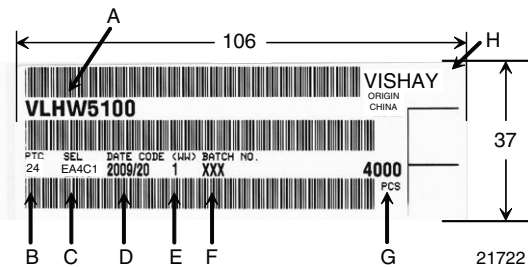

- A) Type of component
- B) Manufacturing plant
- C) SEL - selection code (bin):
 e.g.: EA = code for luminous intensity group
 4C = code for chromaticity coordinate
 1 = code for forward voltage
- D) Date code year/week
- E) Day code (e.g. 1: Monday)
- F) Batch no.
- G) Total quantity
- H) Company code



Disclaimer

ALL PRODUCT, PRODUCT SPECIFICATIONS AND DATA ARE SUBJECT TO CHANGE WITHOUT NOTICE TO IMPROVE RELIABILITY, FUNCTION OR DESIGN OR OTHERWISE.

Vishay Intertechnology, Inc., its affiliates, agents, and employees, and all persons acting on its or their behalf (collectively, "Vishay"), disclaim any and all liability for any errors, inaccuracies or incompleteness contained in any datasheet or in any other disclosure relating to any product.

Vishay makes no warranty, representation or guarantee regarding the suitability of the products for any particular purpose or the continuing production of any product. To the maximum extent permitted by applicable law, Vishay disclaims (i) any and all liability arising out of the application or use of any product, (ii) any and all liability, including without limitation special, consequential or incidental damages, and (iii) any and all implied warranties, including warranties of fitness for particular purpose, non-infringement and merchantability.

Statements regarding the suitability of products for certain types of applications are based on Vishay's knowledge of typical requirements that are often placed on Vishay products in generic applications. Such statements are not binding statements about the suitability of products for a particular application. It is the customer's responsibility to validate that a particular product with the properties described in the product specification is suitable for use in a particular application. Parameters provided in datasheets and/or specifications may vary in different applications and performance may vary over time. All operating parameters, including typical parameters, must be validated for each customer application by the customer's technical experts. Product specifications do not expand or otherwise modify Vishay's terms and conditions of purchase, including but not limited to the warranty expressed therein.

Except as expressly indicated in writing, Vishay products are not designed for use in medical, life-saving, or life-sustaining applications or for any other application in which the failure of the Vishay product could result in personal injury or death. Customers using or selling Vishay products not expressly indicated for use in such applications do so at their own risk and agree to fully indemnify and hold Vishay and its distributors harmless from and against any and all claims, liabilities, expenses and damages arising or resulting in connection with such use or sale, including attorneys fees, even if such claim alleges that Vishay or its distributor was negligent regarding the design or manufacture of the part. Please contact authorized Vishay personnel to obtain written terms and conditions regarding products designed for such applications.

No license, express or implied, by estoppel or otherwise, to any intellectual property rights is granted by this document or by any conduct of Vishay. Product names and markings noted herein may be trademarks of their respective owners.

Material Category Policy

Vishay Intertechnology, Inc. hereby certifies that all its products that are identified as RoHS-Compliant fulfill the definitions and restrictions defined under Directive 2011/65/EU of The European Parliament and of the Council of June 8, 2011 on the restriction of the use of certain hazardous substances in electrical and electronic equipment (EEE) - recast, unless otherwise specified as non-compliant.

Please note that some Vishay documentation may still make reference to RoHS Directive 2002/95/EC. We confirm that all the products identified as being compliant to Directive 2002/95/EC conform to Directive 2011/65/EU.

Компания «Life Electronics» занимается поставками электронных компонентов импортного и отечественного производства от производителей и со складов крупных дистрибьюторов Европы, Америки и Азии.

С конца 2013 года компания активно расширяет линейку поставок компонентов по направлению коаксиальный кабель, кварцевые генераторы и конденсаторы (керамические, пленочные, электролитические), за счёт заключения дистрибьюторских договоров

Мы предлагаем:

- Конкурентоспособные цены и скидки постоянным клиентам.
- Специальные условия для постоянных клиентов.
- Подбор аналогов.
- Поставку компонентов в любых объемах, удовлетворяющих вашим потребностям.
- Приемлемые сроки поставки, возможна ускоренная поставка.
- Доставку товара в любую точку России и стран СНГ.
- Комплексную поставку.
- Работу по проектам и поставку образцов.
- Формирование склада под заказчика.
- Сертификаты соответствия на поставляемую продукцию (по желанию клиента).
- Тестирование поставляемой продукции.
- Поставку компонентов, требующих военную и космическую приемку.
- Входной контроль качества.
- Наличие сертификата ISO.

В составе нашей компании организован Конструкторский отдел, призванный помогать разработчикам, и инженерам.

Конструкторский отдел помогает осуществить:

- Регистрацию проекта у производителя компонентов.
- Техническую поддержку проекта.
- Защиту от снятия компонента с производства.
- Оценку стоимости проекта по компонентам.
- Изготовление тестовой платы монтаж и пусконаладочные работы.



Тел: +7 (812) 336 43 04 (многоканальный)

Email: org@lifeelectronics.ru