



W6/W9 series

Magnetic Hydraulic P&B Circuit Breakers



Features

- Designed for the international market. UL Recognized (UL1077 and UL1500), CSA Accepted and VDE approved.
- Ratings to 50 amps.
- Heavy duty #10-32 stud connections. (W9)
- Quick-connect or screw terminals. (W6)
- Optional 10 amp auxiliary switch.
- Several delay curve options.
- Choice of toggle or rocker actuator per pole or per unit (W6).
- Optional relay/remote trip pole available.
- Trip-free operation.

Agency Approvals

- UL:** Recognized as Supplementary Protector under UL 1077. Available models meet Ignition Protection requirements in accordance with UL1500. File E69543.
- CSA:** Accepted as a Supplementary Protector. File LR15734.
- VDE:** Approved to VDE 0642/EN 60 934 (Circuit Breakers for Equipment) License No. 73782.

Users should thoroughly review the technical data before selecting a product part number. It is recommended that users also seek out the pertinent approvals files of the agencies/laboratories and review them to confirm the product meets the requirements for a given application.

Electrical Data

- Auxiliary Switch:** See Auxiliary Switch Ratings Table 2 for details.
- Calibration:** Breakers will hold 100% of rated current.
Breakers may trip between 101% and 124% of rated load (134% for AC/DC units).
Breakers must trip at 125% of rated load and above (135% for AC/DC units).
- Dielectric Strength:** 50/60 Hz., 1500V: DC, 1100V.
- Insulation Resistance:** 100 Megohms at 500VDC.
- Endurance:** 10,000 on/off cycles - 6000 at rated load, 4000 at no load.
Units tested at six cycles per minute, 1 second on and 9 seconds off at 25°C ambient.
- Relay Trip Coil:** (Ratings applicable to all W6 models with this option)
24 to 277VAC, 150mA minimum available current;
6 to 48VDC, 300mA minimum available current.

Typical Resistance and Impedance

| Current (Amps) | DC Resistance (Ohms) | 50/60 Hz. Impedance (Ohms) |
|----------------|----------------------|----------------------------|
| 0.2 | 90 | 90 |
| 1.0 | 1.2 | 1.2 |
| 2.0 | 0.28 | 0.28 |
| 5.0 | 0.04 | 0.04 |
| 10.0 | 0.013 | 0.013 |
| 20.0 | 0.004 | 0.005 |
| 30.0 | 0.0027 | 0.004 |
| 40.0 | 0.002 | 0.002 |
| 50.0 | 0.0015 | 0.0015 |

Tolerance: 0.1 - 4.99 ± 15%; 5 - 9.99 ± 20%; 10 - 15 ± 25%; 16 - 30 ± 50%.

Mechanical/Environmental Data

- Operating Temperature:** -40°C to +85°C.
- Humidity:** Meets requirements of Mil-STD-202 method 103.
- Shock:** Tested per Mil-STD-202, method 213, test condition C (100g @ 6 ms).
- Vibration:** Tested per Mil-STD-202, method 201, 10-55 Hz., 0.06" (1.52mm) total excursion in 2 planes.
- Fungus And Moisture Resistance:** Special moisture resistant finish applied to all ferrous parts.
Plastic parts are made of inherently fungus resistant material.
- Marking:** International "1" and "0" symbols are marked on the toggle for both W6 and W9. W9 units have "ON" and "OFF" molded into the area at the base of the toggle. On a special order basis, graphics can be imprinted on the rockers of rocker actuated W6 units. VDE approved versions of rocker actuated W6 breakers have their rockers imprinted with "1" and "0."
- Mounting:** Units are mounted with two #6-32 screws from the front of the panel. Metric models for use with M3 x 0.5 screws are available. To maintain published performance specifications, units should not be mounted more than 90° from their normal upright position.
- Weight:** Approximately 2.5 ounces per pole.

Approvals and Ratings Table 1

W6 Series UL1077/CSA (All Circuit Functions)

| Maximum Voltage | Frequency (Hz) | Phase | Current Rating (Amps) | Interrupting Capacity (Amps) |
|-----------------|----------------|--------|-----------------------|------------------------------|
| 65 | DC | - | 0.2 - 50 | 2,000 |
| 277 | 50/60 | 1 | 0.2 - 20 | 5,000 |
| 277 | 50/60 | 1 | 21 - 50 | 2,500 |
| 277/480 | 50/60 | 3Ø-Wye | 0.2 - 20 | 5,000 |

W9 Series UL1077/CSA (All Circuit Functions)

| Maximum Voltage | Frequency (Hz) | Phase | Current Rating (Amps) | Interrupting Capacity (Amps) |
|-----------------|----------------|--------|-----------------------|------------------------------|
| 65 | DC | - | 0.2 - 50 | 2,000 |
| 277 | 50/60 | 1 | 0.2 - 50 | 5,000 |
| 277/480 | 50/60 | 3Ø-Wye | 0.2 - 20 | 5,000 |

W6 or W9 Series VDE (Circuit Function X)

| Maximum Voltage | Frequency (Hz) | Phase | Current Rating (Amps) | Interrupting Capacity (Amps) |
|-----------------|----------------|-------|-----------------------|------------------------------|
| 65 | DC | - | 0.2-50 | 2,000 |
| 250 | 50/60 | 1 | 0.2-30 | 5,000 |
| 250 | 50/60 | 1 | 31-50 | 2,000 |
| 415/240 | 50/60 | 3Ø | 0.2-30 | 5,000 |

W6 or W9 Series UL1500 (Circuit Function X)

| Maximum Voltage | Frequency (Hz) | Phase | Current Rating (Amps) | Interrupting Capacity (Amps) |
|-----------------|----------------|--------|-----------------------|------------------------------|
| 48 | DC | - | 0.2 - 50 | 3,000 |
| 125/250 | 50/60 | 1 | 0.2 - 50 | 1,000 |
| 250 | 50/60 | 3Ø-Wye | 0.2 - 50 | 1,000 |

Auxiliary Switch Ratings Table 2

UL/CSA

| Switch Number | Voltage 50/60 Hz. | Current (Amps) | Terminals WxTxL |
|---------------|-------------------|----------------|---|
| A | 125 | 10 | .093 x .020 x .250 (2.36 x .51 x 6.40) |

Time vs. Current Trip Curves For W6 Series and W9 Series

AC 50/60 Hz.



DC



AC/DC



Note:
For instantaneous curves for all voltages refer to Curve 0 Instantaneous under the AC 50/60 Hz. heading.

Pulse Tolerance Specifications

Pulse tolerance is defined as a single pulse of a half sine wave (1/2 cycle or 8 milliseconds) that will not trip the breaker. An inertia wheel for increased pulse tolerance is available by specifying "P" after the time delay curve number in the ordering information. The table at right lists pulse tolerance values of standard and inertia delay models.

| Voltage | Time Delay Curve | Pulse Tolerance Value | |
|--------------|------------------|-----------------------|---------------|
| | | Standard | Inertia Delay |
| AC 50/60 Hz. | 2 | 7.5 | 18 |
| | 3 | 6 | 18 |
| | 10 | 18 | 30 |
| | 12 | 18 | 30 |
| | 13 | 18 | 30 |

To determine pulse tolerance multiply breaker rating by value in table. For example, a 2A breaker with time delay curve 3 has a standard pulse tolerance of 12A (2A x 6). The same breaker with an inertia delay has a pulse tolerance of 36A (2A x 18).

Ordering Information

W6 Series

Typical Part No. >

W 67- X 2 Q 1 2- 20

1. Circuit Breaker Mounting:

W = #6-32 mounting threads.
M = M3.0 x 0.5 mounting threads.

2. Number of Poles:

67 = Single pole 68 = Two pole 69 = Three pole 70 = Four pole

3. Circuit Function: (Only X is VDE approved)

A = Series trip with auxiliary switch (.093" QC)
X = Series trip
D = Series trip with auxiliary relay trip pole (requires extra pole package, 3 pole (4 pole package) max., must specify #10-32 screw terminals below, but relay trip pole will be equipped with .250" QC term. only, not UL), relay trip pole will be on the right side of the breaker when viewed from the front.

4. Actuator:

One actuator per pole

1 = Black toggle 3 = Black rocker 5 = Red rocker 9 = Red toggle
2 = White toggle 4 = White rocker 6 = Grey rocker

One actuator per unit

7 = Black toggle 8 = White toggle J = Black rocker

5. Termination:

Q = .250" QC (DIN 46 244) [30A Max. UL/CSA; 25A Max. VDE]
S = #8-32 screw [30A Max.]
T = #10-32 screw [50A Max.]
U = #8-32 screw, nickel plated, bent inward 30° [30A Max.]
V = #10-32 screw, nickel plated, bent inward 30° [50A Max.]

Notes: #10-32 termination must be used for **all** ratings of greater than 30 amps.
#10-32 termination must be specified for circuit function D, but relay trip pole will be equipped with .250" QC.

6. Maximum Line Voltage: (See Table 1 for current ranges)

UL/CSA 1 = 277VAC, 50/60 Hz.

TYPES 2 = 277/480VAC, 50/60 Hz. [20A Max.] (Requires insulating barriers, see outline dimension drawing)
5 = 65VDC
7 = AC/DC 277VAC, 50/60 Hz. or 65VDC
(Time delay curve 34 must be specified.)
8 = AC/DC 120VAC, 120/240VAC, 48VDC
(Agency Approval M [UL1500] and time delay curve 34 must be specified.)

VDE 1 = 250VAC, 415/240VAC

TYPES 5 = 65VDC
7 = AC/DC 250VAC, 415/240VAC, 65VDC
(Time delay curve 34 must be specified.)

7. Time Delay Curve:

0 = Instantaneous 10 = AC high inrush motor start / long delay
2 = Standard delay 12 = AC high inrush version of #2
3 = Short delay 13 = AC high inrush version of #3
53 = DC high inrush 34 = Combination AC/DC standard delay

Notes: Curves may be specified with increased pulse tolerance for 1/2 cycle by adding "P" after curve.
See delay curve section for availability and details.

8. Amp Rating:

| | | | | | | | | | | | | | | |
|------|------|-----|-----|-----|-----|-----|-----|------|------|------|------|------|------|-----------------------------------|
| 0.20 | 0.50 | 1.0 | 2.0 | 3.0 | 4.0 | 6.0 | 7.5 | 9.0 | 11.0 | 15.0 | 25.0 | 35.0 | 45.0 | Consult factory for other values. |
| 0.25 | 0.75 | 1.5 | 2.5 | 3.5 | 5.0 | 7.0 | 8.0 | 10.0 | 12.0 | 20.0 | 30.0 | 40.0 | 50.0 | |

9. Agency Approval:

Blank = UL1077/CSA breaker
V = VDE approved breaker without auxiliary switch
M = UL1077/UL1500 ignition protected breaker

Authorized distributors are more likely to stock the following items.

| | | | | | | | |
|--------------|--------------|--------------|--------------|---------------|--------------|---------------|---------------|
| W67-A2Q12-5 | W67-X2Q12-5 | W67-X2Q13-1 | W67-X2Q13-25 | W67-X2Q52-15 | W68-X2Q12-5 | W68-X2Q12-30 | W69-X2Q12-15 |
| W67-A2Q12-10 | W67-X2Q12-7 | W67-X2Q13-2 | W67-X2Q13-30 | W67-X2Q52-20 | W68-X2Q12-7 | W68-X2Q13-15 | W69-X2Q12-20 |
| W67-X2Q10-3 | W67-X2Q12-10 | W67-X2Q13-3 | W67-X2Q50-5 | W67-X2Q52-30 | W68-X2Q12-10 | W68-X2Q110-10 | W69-X2Q12-25 |
| W67-X2Q10-5 | W67-X2Q12-15 | W67-X2Q13-10 | W67-X2Q50-10 | W67-X2Q110-15 | W68-X2Q12-15 | W68-X2Q110-20 | W69-X2Q12-30 |
| W67-X2Q12-2 | W67-X2Q12-20 | W67-X2Q13-15 | W67-X2Q52-5 | W67-X2Q110-20 | W68-X2Q12-20 | W69-X2Q12-5 | W69-X2Q110-20 |
| W67-X2Q12-3 | W67-X2Q12-30 | W67-X2Q13-20 | W67-X2Q52-10 | W68-X2Q12-3 | W68-X2Q12-25 | W69-X2Q12-10 | W69-X2Q110-30 |

Ordering Information

W9 Series

Typical Part No. >

W 91- X 1 1 2- 20

1. Circuit Breaker Mounting:

W = #6-32 mounting threads.
M = M3.0 x 0.5 mounting threads.

2. Number of Poles:

91 = Single pole 92 = Two pole 93 = Three pole 94 = Four pole

3. Circuit Function: (Only X is VDE approved)

A = Series trip with auxiliary switch (.093" QC)
X = Series trip
D = Series trip with auxiliary relay trip pole (requires extra pole package, 3 pole max., not UL)

4. Actuator:

One actuator per pole:

1 = Black toggle 2 = White toggle

5. Maximum Line Voltage: (See Table 1 for current ranges)

UL/CSA TYPES
1 = 277VAC, 50/60 Hz.
2 = 277/480VAC, 50/60 Hz. [20A Max.]
5 = 65VDC
7 = AC/DC 277VAC, 50/60 Hz. or 65VDC
(Time delay curve 34 must be specified.)
8 = AC/DC 120VAC, 120/240VAC, 48VDC
(Agency Approval M [UL1500] and time delay curve 34 must be specified.)

VDE TYPES
1 = 250VAC, 415/240VAC
5 = 65VDC
7 = AC/DC 250VAC, 415/240VAC, 65VDC
(Time delay curve 34 must be specified.)

6. Time Delay Curve:

0 = Instantaneous 10 = AC high inrush motor start / long delay
2 = Standard delay 12 = AC high inrush version of #2
3 = Short delay 13 = AC high inrush version of #3
53 = DC high inrush 34 = Combination AC/DC standard delay

Notes: Curves may be specified with increased pulse tolerance for 1/2 cycle by adding "P" after curve.
See delay curve section for availability and details.

7. Amp Rating:

| | | | | | | | | | |
|------|------|-----|-----|-----|------|------|------|------|----------------------------------|
| 0.20 | 0.75 | 2.0 | 3.5 | 6.0 | 8.0 | 11.0 | 20.0 | 35.0 | 50.0 |
| 0.25 | 1.0 | 2.5 | 4.0 | 7.0 | 9.0 | 12.0 | 25.0 | 40.0 | Consult factory for other values |
| 0.50 | 1.5 | 3.0 | 5.0 | 7.5 | 10.0 | 15.0 | 30.0 | 45.0 | |

8. Agency Approval:

Blank = UL1077/CSA approved breaker
V = VDE approved breaker without auxiliary switch
M = UL1077/UL1500 ignition protected breaker

Authorized distributors are more likely to stock the following items.

| | | | | | | | |
|-------------|-------------|-------------|--------------|-------------|--------------|--------------|--------------|
| W91-X112-1 | W91-X112-15 | W91-X113-15 | W91-X152-40 | W92-X112-5 | W92-X112-30 | W92-X1110-30 | W93-X112-30 |
| W91-X112-2 | W91-X112-20 | W91-X150-5 | W91-X152-50 | W92-X112-7 | W92-X112-40 | W93-X112-5 | W93-X112-40 |
| W91-X112-3 | W91-X112-40 | W91-X152-10 | W91-X1110-20 | W92-X112-10 | W92-X112-50 | W93-X112-10 | W93-X112-50 |
| W91-X112-5 | W91-X112-50 | W91-X152-15 | W92-X112-1 | W92-X112-15 | W92-X113-15 | W93-X112-15 | W93-X1110-20 |
| W91-X112-7 | W91-X113-5 | W91-X152-20 | W92-X112-2 | W92-X112-20 | W92-X113-20 | W93-X112-20 | W93-X1110-30 |
| W91-X112-10 | W91-X113-10 | W91-X152-30 | W92-X112-3 | W92-X112-25 | W92-X1110-20 | W93-X112-25 | |

Outline Dimensions - Toggle Actuator Models

W6 Series

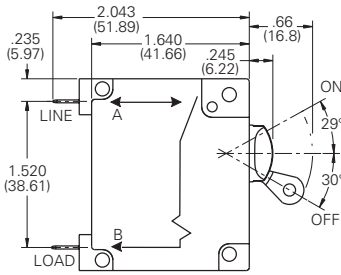

Panel Mounting Cutout

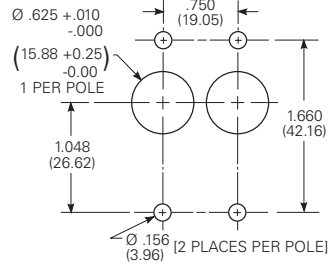

W6 Series – One Actuator Per Pole

1 Pole

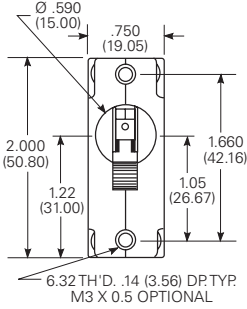

2 Pole

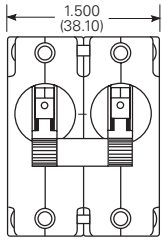

3 Pole

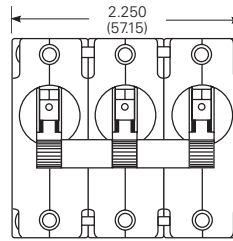

4 Pole

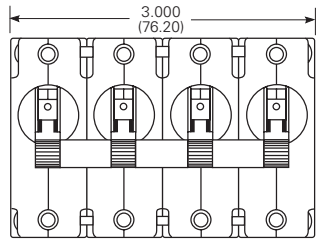

Note: Multi-pole models furnished with separate handle tie hardware.

W6 Series – One Actuator Per Unit

1 Pole

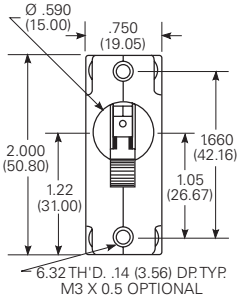

2 Pole

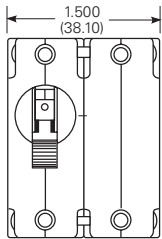

3 Pole

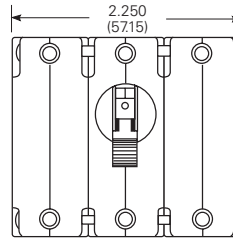

4 Pole

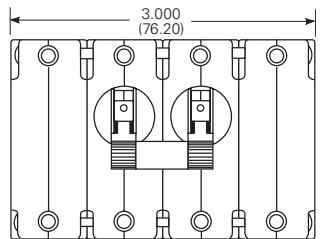

Note: 4-pole models furnished with separate handle tie hardware.

480V Model with Barriers

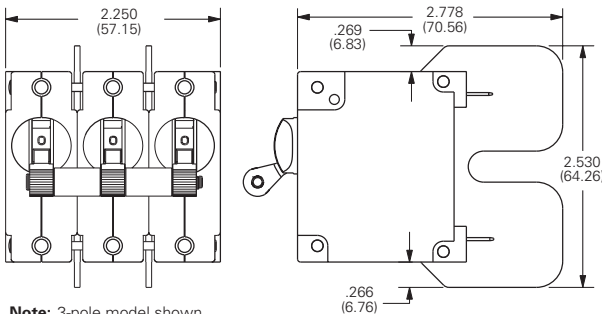

Note: 3-pole model shown.

Model with Aux. Relay Trip Pole



Note: W68 -D model shown. Note that the auxiliary relay trip pole is on the right. #10-32 screw terminals must be specified with this option; however, the terminals on the relay trip pole are 0.250" quick connects. The relay pole is self-opening, so the trip current can remain energized indefinitely.

Termination Options

Notes:

- Terminal protrusion dimensions are referenced from back of mounting panel.
- Main terminals are male quick connect type .250 (6.35) wide x .031 (.79) thick x .377 (9.58) long. Optional 8-32 x .250 (6.35) or 10-32 x .250 (6.35) screw type.
- Panel mounting cutout detail mtg. detail tol.: ± .005 (.13) unless noted. Add additional cutouts to correspond to number of poles. Outline drawing tolerance ± .015 (.38) unless noted.

UL/CSA Models W/Screw Terminals



UL/CSA Models W/Terminals Bent 30°



VDE Models W/Screw Terminals



UL/CSA/VDE Models W/Aux. Switch

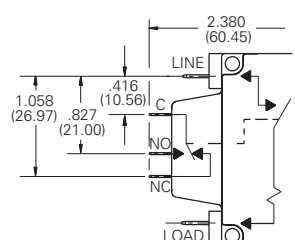

Outline Dimensions - Optional Toggle Guards

W6 Series



84-004 toggle guard shown with W67 series circuit breaker mounted in a panel.

Optional toggle guards may be ordered separately for use on W6 toggle actuator models. These guards help to prevent accidental operation and allow the breaker to be locked in the "off" position.

Outline Dimensions - Rocker Actuator Models

W6 Series



Panel Mounting Cutout



VDE Rocker Marking



Notes:

1. Outline drawing tolerance $\pm .015$ (.38) unless noted. Dimensions in brackets () are in millimeters.
2. Mounting Detail Tol.: $\pm .005$ (.13) unless noted

Outline Dimensions

W9 Series

Series Trip Model



Note:
1. Top mounted plate (shown with broken line) is present only on UL1500 models.

Series Trip Model



Series Trip Model

With Common Enclosed Auxiliary Switch

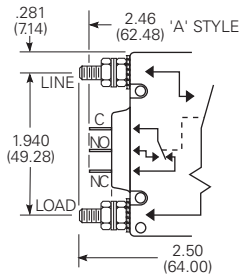

Panel Mounting Cutout Detail

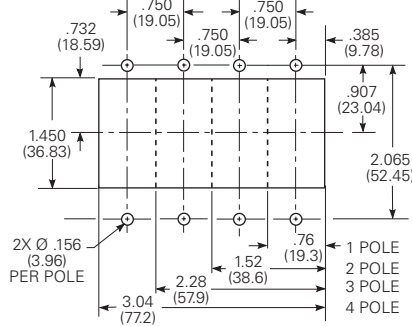

Notes:
1. Terminal protrusion dimensions are referenced from the back of the mounting panel.
2. Mounting detail tolerance ±.005 (13) unless noted.
3. Outline drawing tolerance ±.015 (.38) unless noted. Dimensions in brackets () are in millimeters.

Disclaimer:

While Tyco Electronics and its affiliates referenced herein have made every reasonable effort to ensure the accuracy of the information contained in this document, Tyco Electronics cannot assure that this information is error free. For this reason, Tyco Electronics does not make any representation or offer any guarantee that such information is accurate, correct, reliable or current. Tyco Electronics reserves the right to make any adjustments to the information at any time. Tyco Electronics expressly disclaims any implied warranty regarding the information contained herein, including, but not limited to, the implied warranties of merchantability or fitness for a particular purpose. Tyco Electronics' only obligations are those stated in Tyco Electronics' Standard Terms and Conditions of Sale. Tyco Electronics will in no case be liable for any incidental, indirect or consequential damages arising from or in connection with, including, but not limited to, the sale, resale, use or misuse of its products. Users should rely on their own judgment to evaluate the suitability of a product for a certain purpose and test each product for its intended application.

In case of any potential ambiguities or questions, please don't hesitate to contact us for clarification.

Компания «Life Electronics» занимается поставками электронных компонентов импортного и отечественного производства от производителей и со складов крупных дистрибьюторов Европы, Америки и Азии.

С конца 2013 года компания активно расширяет линейку поставок компонентов по направлению коаксиальный кабель, кварцевые генераторы и конденсаторы (керамические, пленочные, электролитические), за счёт заключения дистрибьюторских договоров

Мы предлагаем:

- Конкурентоспособные цены и скидки постоянным клиентам.
- Специальные условия для постоянных клиентов.
- Подбор аналогов.
- Поставку компонентов в любых объемах, удовлетворяющих вашим потребностям.
- Приемлемые сроки поставки, возможна ускоренная поставка.
- Доставку товара в любую точку России и стран СНГ.
- Комплексную поставку.
- Работу по проектам и поставку образцов.
- Формирование склада под заказчика.
- Сертификаты соответствия на поставляемую продукцию (по желанию клиента).
- Тестирование поставляемой продукции.
- Поставку компонентов, требующих военную и космическую приемку.
- Входной контроль качества.
- Наличие сертификата ISO.

В составе нашей компании организован Конструкторский отдел, призванный помогать разработчикам, и инженерам.

Конструкторский отдел помогает осуществить:

- Регистрацию проекта у производителя компонентов.
- Техническую поддержку проекта.
- Защиту от снятия компонента с производства.
- Оценку стоимости проекта по компонентам.
- Изготовление тестовой платы монтаж и пусконаладочные работы.



Тел: +7 (812) 336 43 04 (многоканальный)

Email: org@lifeelectronics.ru