

Feed-through terminal block - UKK 3-MSTB-5,08 BU - 2770286

Please be informed that the data shown in this PDF Document is generated from our Online Catalog. Please find the complete data in the user's documentation. Our General Terms of Use for Downloads are valid (<http://download.phoenixcontact.com>)



Feed-through terminal block, Nominal current: 10 A, Nominal voltage: 250 V, Cross section: 0.2 mm² - 4 mm², AWG: 24 - 12, Mounting type: NS 35/7,5, NS 35/15, NS 32, Number of positions: 1, Pitch: 5.08 mm, Width: 5.1, Color: blue

The illustration shows the article UKK 3-MSTB-5,08



Key commercial data

Packing unit	1 1
Weight per Piece (excluding packing)	8.78 GRM
Custom tariff number	85369010
Country of origin	Germany

Technical data

General

Number of levels	2
Number of connections	4
Color	blue
Insulating material	PA
Inflammability class according to UL 94	V2
Maximum load current	12 A (with 4 mm ² conductor cross section)
Rated surge voltage	4 kV
Pollution degree	3
Surge voltage category	III
Insulating material group	I
Nominal current I _N	10 A
Nominal voltage U _N	250 V
Number of positions	1

Connection data

Feed-through terminal block - UKK 3-MSTB-5,08 BU - 2770286

Technical data

Connection data

Connection labeling	1st and 2nd level connection left
Conductor cross section solid min.	0.2 mm ²
Conductor cross section solid max.	4 mm ²
Conductor cross section stranded min.	0.2 mm ²
Conductor cross section stranded max.	2.5 mm ²
Conductor cross section AWG/kcmil min.	24
Conductor cross section AWG/kcmil max	12
Conductor cross section stranded, with ferrule without plastic sleeve min.	0.25 mm ²
Conductor cross section stranded, with ferrule without plastic sleeve max.	2.5 mm ²
Conductor cross section stranded, with ferrule with plastic sleeve min.	0.25 mm ²
Conductor cross section stranded, with ferrule with plastic sleeve max.	1.5 mm ²
2 conductors with same cross section, solid min.	0.2 mm ²
2 conductors with same cross section, solid max.	1.5 mm ²
2 conductors with same cross section, stranded min.	0.2 mm ²
2 conductors with same cross section, stranded max.	1 mm ²
2 conductors with same cross section, stranded, ferrules without plastic sleeve, min.	0.25 mm ²
2 conductors with same cross section, stranded, ferrules without plastic sleeve, max.	0.5 mm ²
2 conductors with same cross section, stranded, TWIN ferrules with plastic sleeve, min.	0.5 mm ²
2 conductors with same cross section, stranded, TWIN ferrules with plastic sleeve, max.	1 mm ²
Connection method	Special and hybrid connection
Stripping length	8 mm
Internal cylindrical gage	A3
Screw thread	M3
Tightening torque, min	0.5 Nm
Tightening torque max	0.6 Nm

Classifications

eCl@ss

eCl@ss 4.0	27141118
eCl@ss 4.1	27141118
eCl@ss 5.0	27141118
eCl@ss 5.1	27141118
eCl@ss 6.0	27141120

Feed-through terminal block - UKK 3-MSTB-5,08 BU - 2770286

Classifications

eCl@ss

eCl@ss 7.0	27141120
eCl@ss 8.0	27141120

ETIM

ETIM 2.0	EC000897
ETIM 3.0	EC000897
ETIM 4.0	EC000897
ETIM 5.0	EC000897

UNSPSC

UNSPSC 6.01	30211811
UNSPSC 7.0901	39121410
UNSPSC 11	39121410
UNSPSC 12.01	39121410
UNSPSC 13.2	39121410

Approvals

Approvals

Approvals

CSA / UL Recognized / cUL Recognized / UL Recognized / GOST / GOST / cULus Recognized

Ex Approvals

Approvals submitted

Approval details

CSA 	
mm ² /AWG/kcmil	28-12
Nominal current I _N	10 A
Nominal voltage U _N	300 V

Feed-through terminal block - UKK 3-MSTB-5,08 BU - 2770286

Approvals

UL Recognized 

mm ² /AWG/kcmil	30-12
Nominal current IN	10 A
Nominal voltage UN	300 V

cUL Recognized 



		B	D
mm ² /AWG/kcmil	30-12	30-12	30-12
Nominal current IN	10 A	10 A	10 A
Nominal voltage UN	300 V	250 V	300 V

UL Recognized 

		B	D
mm ² /AWG/kcmil	30-12	30-12	30-12
Nominal current IN	10 A	10 A	10 A
Nominal voltage UN	300 V	250 V	300 V

GOST 

GOST 

cULus Recognized  

Accessories

Accessories

Feed-through terminal block - UKK 3-MSTB-5,08 BU - 2770286

Accessories

Bridge

Insertion bridge - EBL 3- 5 - 2303158



Insertion bridge, Number of positions: 3, Color: gray

Insertion bridge - EBL 2- 5 - 2303145



Insertion bridge, Number of positions: 2, Color: gray

End block

End clamp - CLIPFIX 35 - 3022218



Quick mounting end clamp for NS 35/7,5 DIN rail or NS 35/15 DIN rail, with marking option, width: 9.5 mm, color: gray

End clamp - CLIPFIX 35-5 - 3022276



Quick mounting end clamp for NS 35/7,5 DIN rail or NS 35/15 DIN rail, with marking option, with parking option for FBS...5, FBS...6, KSS 5, KSS 6, width: 5.15 mm, color: gray

End clamp - E/NS 35 N - 0800886



End clamp, width: 9.5 mm, color: gray

Feed-through terminal block - UKK 3-MSTB-5,08 BU - 2770286

Accessories

End clamp - E/UK - 1201442



End clamp, for assembly on NS 32 or NS 35/7.5 DIN rail

End clamp - E/UK 1 - 1201413



End clamps, for supporting the ends of double-level and three-level terminal blocks, width: 10 mm, color: gray

End cover

End cover - D-UKK 3-MSTB-5,08 L - 2770914



End cover, Length: 50 mm, Width: 2.5 mm, Height: 53.5 mm, Color: gray

End cover - D-UKK 3-MSTB-5,08 - 2770891



End cover, Length: 50 mm, Width: 2.5 mm, Height: 53.5 mm, Number of positions: 1, Color: gray

Labeled terminal marker

Feed-through terminal block - UKK 3-MSTB-5,08 BU - 2770286

Accessories

Zack marker strip - ZB 5,08 CUS - 0824963



Zack marker strip, Can be ordered: Strip, white, red, ..., Labeled according to customer specifications, Mounting type: Snap into tall marker groove, For terminal block width: 5.08 mm, Lettering field: 4.98 x 10.5 mm

Mounting rail

DIN rail - NS 32 PERF 2000MM - 1201002



G-profile DIN rail, material: Steel, perforated, height 15 mm, width 32 mm, length 2 m

DIN rail - NS 32 UNPERF 2000MM - 1201015



G-profile DIN rail, material: Steel, unperforated, height 15 mm, width 32 mm, length 2 m

DIN rail perforated - NS 35/ 7,5 PERF 2000MM - 0801733



DIN rail, material: steel galvanized and passivated with a thick layer, perforated, height 7.5 mm, width 35 mm, length: 2000 mm

DIN rail - NS 35/ 7,5 UNPERF 2000MM - 0801681



DIN rail, material: Steel, unperforated, height 7.5 mm, width 35 mm, length: 2 m

Feed-through terminal block - UKK 3-MSTB-5,08 BU - 2770286

Accessories

DIN rail - NS 35/ 7,5 WH PERF 2000MM - 1204119



DIN rail 35 mm (NS 35)

DIN rail - NS 35/ 7,5 WH UNPERF 2000MM - 1204122



DIN rail 35 mm (NS 35)

DIN rail, unperforated - NS 35/ 7,5 AL UNPERF 2000MM - 0801704



DIN rail, unperforated, Width: 35 mm, Height: 7.5 mm, Length: 2000 mm, Color: silver

DIN rail - NS 35/ 7,5 ZN PERF 2000MM - 1206421



DIN rail, material: Galvanized, perforated, height 7.5 mm, width 35 mm, length: 2 m

DIN rail - NS 35/ 7,5 ZN UNPERF 2000MM - 1206434



DIN rail, material: Galvanized, unperforated, height 7.5 mm, width 35 mm, length: 2 m

Feed-through terminal block - UKK 3-MSTB-5,08 BU - 2770286

Accessories

DIN rail - NS 35/ 7,5 CU UNPERF 2000MM - 0801762



DIN rail, material: Copper, unperforated, height 7.5 mm, width 35 mm, length: 2 m

End cap - NS 35/ 7,5 CAP - 1206560



DIN rail end piece, for DIN rail NS 35/7.5

DIN rail perforated - NS 35/15 PERF 2000MM - 1201730



DIN rail, material: steel galvanized and passivated with a thick layer, perforated, height 15 mm, width 35 mm, length: 2000 mm

DIN rail - NS 35/15 UNPERF 2000MM - 1201714



DIN rail, material: Steel, unperforated, height 15 mm, width 35 mm, length: 2 m

DIN rail - NS 35/15 WH PERF 2000MM - 0806602



DIN rail 35 mm (NS 35)

Feed-through terminal block - UKK 3-MSTB-5,08 BU - 2770286

Accessories

DIN rail - NS 35/15 WH UNPERF 2000MM - 1204135



DIN rail 35 mm (NS 35)

DIN rail, unperforated - NS 35/15 AL UNPERF 2000MM - 1201756



DIN rail, deep drawn, high profile, unperforated, 1.5 mm thick, material: aluminum, height 15 mm, width 35 mm, length 2000 mm

DIN rail - NS 35/15 ZN PERF 2000MM - 1206599



DIN rail, material: Galvanized, perforated, height 15 mm, width 35 mm, length: 2 m

DIN rail - NS 35/15 ZN UNPERF 2000MM - 1206586



DIN rail, material: Galvanized, unperforated, height 15 mm, width 35 mm, length: 2 m

DIN rail - NS 35/15 CU UNPERF 2000MM - 1201895



DIN rail, material: Copper, unperforated, 1.5 mm thick, height 15 mm, width 35 mm, length: 2 m

Feed-through terminal block - UKK 3-MSTB-5,08 BU - 2770286

Accessories

End cap - NS 35/15 CAP - 1206573



DIN rail end piece, for DIN rail NS 35/15

DIN rail - NS 35/15-2,3 UNPERF 2000MM - 1201798



DIN rail, material: Steel, unperforated, 2.3 mm thick, height 15 mm, width 35 mm, length: 2 m

Partition plate

Spacer plate - DP-UKK 3-MSTB-5,08 - 2770600



Spacer plate, Length: 50 mm, Width: 2.5 mm, Number of positions: 1, Color: gray

Feed-through terminal block - DG-UKK 3-MSTB-5,08 - 2770613



Spacer cover, width: 2.5 mm, color: Gray

Screwdriver tools

Screwdriver - SZS 0,6X3,5 - 1205053



Actuation tool, for ST terminal blocks, insulated, also suitable for use as a bladed screwdriver, size: 0.6 x 3.5 x 100 mm, 2-component grip, with non-slip grip

Feed-through terminal block - UKK 3-MSTB-5,08 BU - 2770286

Accessories

Terminal marking

Marker cards - SBS 5:UNBEDRUCKT - 1007219



Marker cards, Card, white, Unlabeled, Can be labeled with: Plotter, Perforated, Mounting type: Snap into tall marker groove, Snap into flat marker groove, For terminal block width: 5.2 mm, Lettering field: 6 x 5.1 mm

Zack marker strip - ZB 5,08:UNBEDRUCKT - 0809793



Zack marker strip, Strip, white, Unlabeled, Can be labeled with: Plotter, Mounting type: Snap into tall marker groove, For terminal block width: 5.08 mm, Lettering field: 4.98 x 10.5 mm

Additional products

Printed-circuit board connector - MSTB 2,5/10-ST-5,08 - 1757093



Plug component, Nominal current: 12 A, Rated voltage (III/2): 320 V, Number of positions: 10, Pitch: 5.08 mm, Connection method: Screw connection, Color: green, Contact surface: Tin

Printed-circuit board connector - MSTB 2,5/11-ST-5,08 - 1757103



Plug component, Nominal current: 12 A, Rated voltage (III/2): 320 V, Number of positions: 11, Pitch: 5.08 mm, Connection method: Screw connection, Color: green, Contact surface: Tin

Feed-through terminal block - UKK 3-MSTB-5,08 BU - 2770286

Accessories

Printed-circuit board connector - MSTB 2,5/15-ST-5,08 - 1757145

Plug component, Nominal current: 12 A, Rated voltage (III/2): 320 V, Number of positions: 15, Pitch: 5.08 mm, Connection method: Screw connection, Color: green, Contact surface: Tin



Printed-circuit board connector - MSTB 2,5/16-ST-5,08 - 1757158

Plug component, Nominal current: 12 A, Rated voltage (III/2): 320 V, Number of positions: 16, Pitch: 5.08 mm, Connection method: Screw connection, Color: green, Contact surface: Tin



Printed-circuit board connector - MSTB 2,5/18-ST-5,08 - 1757174

Plug component, Nominal current: 12 A, Rated voltage (III/2): 320 V, Number of positions: 18, Pitch: 5.08 mm, Connection method: Screw connection, Color: green, Contact surface: Tin



Printed-circuit board connector - MSTB 2,5/20-ST-5,08 - 1757190

Plug component, Nominal current: 12 A, Rated voltage (III/2): 320 V, Number of positions: 20, Pitch: 5.08 mm, Connection method: Screw connection, Color: green, Contact surface: Tin



Printed-circuit board connector - MSTB 2,5/ 2-ST-5,08 - 1757019

Plug component, Nominal current: 12 A, Rated voltage (III/2): 320 V, Number of positions: 2, Pitch: 5.08 mm, Connection method: Screw connection, Color: green, Contact surface: Tin



Feed-through terminal block - UKK 3-MSTB-5,08 BU - 2770286

Accessories

Printed-circuit board connector - MSTB 2,5/ 9-ST-5,08 - 1757080



Plug component, Nominal current: 12 A, Rated voltage (III/2): 320 V, Number of positions: 9, Pitch: 5.08 mm, Connection method: Screw connection, Color: green, Contact surface: Tin

Printed-circuit board connector - MSTB 2,5/ 7-STZ-5,08 - 1776113



Plug component, Nominal current: 12 A, Rated voltage (III/2): 320 V, Number of positions: 7, Pitch: 5.08 mm, Connection method: Screw connection, Color: green, Contact surface: Tin

Printed-circuit board connector - MSTB 2,5/ 5-STZ-5,08 - 1776142



Plug component, Nominal current: 12 A, Rated voltage (III/2): 320 V, Number of positions: 5, Pitch: 5.08 mm, Connection method: Screw connection, Color: green, Contact surface: Tin

Printed-circuit board connector - MSTB 2,5/ 4-STZ-5,08 - 1776155



Plug component, Nominal current: 12 A, Rated voltage (III/2): 320 V, Number of positions: 4, Pitch: 5.08 mm, Connection method: Screw connection, Color: green, Contact surface: Tin

Printed-circuit board connector - MSTB 2,5/12-STZ-5,08 - 1764280



Plug component, Nominal current: 12 A, Rated voltage (III/2): 320 V, Number of positions: 12, Pitch: 5.08 mm, Connection method: Screw connection, Color: green, Contact surface: Tin

Feed-through terminal block - UKK 3-MSTB-5,08 BU - 2770286

Accessories

Printed-circuit board connector - MSTB 2,5/ 6-STZ-5,08 - 1776126



Plug component, Nominal current: 12 A, Rated voltage (III/2): 320 V, Number of positions: 6, Pitch: 5.08 mm, Connection method: Screw connection, Color: green, Contact surface: Tin

Printed-circuit board connector - MSTB 2,5/16-STZ-5,08 - 1764248



Plug component, Nominal current: 12 A, Rated voltage (III/2): 320 V, Number of positions: 16, Pitch: 5.08 mm, Connection method: Screw connection, Color: green, Contact surface: Tin

Printed-circuit board connector - MSTB 2,5/ 9-STZ-5,08 - 1764316



Plug component, Nominal current: 12 A, Rated voltage (III/2): 320 V, Number of positions: 9, Pitch: 5.08 mm, Connection method: Screw connection, Color: green, Contact surface: Tin

Printed-circuit board connector - MSTBP 2,5/ 4-ST-5,08 - 1769036



Plug component, Nominal current: 12 A, Rated voltage (III/2): 320 V, Number of positions: 4, Pitch: 5.08 mm, Connection method: Screw connection, Color: green, Contact surface: Tin

Printed-circuit board connector - MSTBP 2,5/16-ST-5,08 - 1769159



Plug component, Nominal current: 12 A, Rated voltage (III/2): 320 V, Number of positions: 16, Pitch: 5.08 mm, Connection method: Screw connection, Color: green, Contact surface: Tin

Feed-through terminal block - UKK 3-MSTB-5,08 BU - 2770286

Accessories

Printed-circuit board connector - MSTBP 2,5/ 6-ST-5,08 - 1769052



Plug component, Nominal current: 12 A, Rated voltage (III/2): 320 V, Number of positions: 6, Pitch: 5.08 mm, Connection method: Screw connection, Color: green, Contact surface: Tin

Printed-circuit board connector - MSTBP 2,5/17-ST-5,08 - 1769162



Plug component, Nominal current: 12 A, Rated voltage (III/2): 320 V, Number of positions: 17, Pitch: 5.08 mm, Connection method: Screw connection, Color: green, Contact surface: Tin

Plug - MSTBP 2,5/24-ST-5,08 - 1769696



Plug component, Nominal current: 12 A, Rated voltage (III/2): 320 V, Number of positions: 24, Pitch: 5.08 mm, Connection method: Screw connection, Color: green, Contact surface: Tin

Printed-circuit board connector - MSTBP 2,5/ 8-ST-5,08 - 1769078



Plug component, Nominal current: 12 A, Rated voltage (III/2): 320 V, Number of positions: 8, Pitch: 5.08 mm, Connection method: Screw connection, Color: green, Contact surface: Tin

Printed-circuit board connector - MSTBP 2,5/ 9-ST-5,08 - 1769081



Plug component, Nominal current: 12 A, Rated voltage (III/2): 320 V, Number of positions: 9, Pitch: 5.08 mm, Connection method: Screw connection, Color: green, Contact surface: Tin

Feed-through terminal block - UKK 3-MSTB-5,08 BU - 2770286

Accessories

Printed-circuit board connector - MSTBP 2,5/13-ST-5,08 - 1769120



Plug component, Nominal current: 12 A, Rated voltage (III/2): 320 V, Number of positions: 13, Pitch: 5.08 mm, Connection method: Screw connection, Color: green, Contact surface: Tin

Printed-circuit board connector - MSTBP 2,5/20-ST-5,08 - 1769191



Plug component, Nominal current: 12 A, Rated voltage (III/2): 320 V, Number of positions: 20, Pitch: 5.08 mm, Connection method: Screw connection, Color: green, Contact surface: Tin

Printed-circuit board connector - MSTBT 2,5/15-ST-5,08 - 1781111



Plug component, Nominal current: 12 A, Rated voltage (III/2): 320 V, Number of positions: 15, Pitch: 5.08 mm, Connection method: Screw connection, Color: green, Contact surface: Tin

Printed-circuit board connector - MSTBT 2,5/ 3-ST-5,08 - 1779990



Plug component, Nominal current: 12 A, Rated voltage (III/2): 320 V, Number of positions: 3, Pitch: 5.08 mm, Connection method: Screw connection, Color: green, Contact surface: Tin

Printed-circuit board connector - MSTBT 2,5/16-ST-5,08 - 1781124



Plug component, Nominal current: 12 A, Rated voltage (III/2): 320 V, Number of positions: 16, Pitch: 5.08 mm, Connection method: Screw connection, Color: green, Contact surface: Tin

Feed-through terminal block - UKK 3-MSTB-5,08 BU - 2770286

Accessories

Printed-circuit board connector - SMSTB 2,5/ 4-ST-5,08 - 1826306

Plug component, Nominal current: 12 A, Rated voltage (III/2): 320 V, Number of positions: 4, Pitch: 5.08 mm, Connection method: Screw connection, Color: green, Contact surface: Tin



Printed-circuit board connector - SMSTB 2,5/ 5-ST-5,08 - 1826319

Plug component, Nominal current: 12 A, Rated voltage (III/2): 320 V, Number of positions: 5, Pitch: 5.08 mm, Connection method: Screw connection, Color: green, Contact surface: Tin



Printed-circuit board connector - SMSTB 2,5/10-ST-5,08 - 1826364

Plug component, Nominal current: 12 A, Rated voltage (III/2): 320 V, Number of positions: 10, Pitch: 5.08 mm, Connection method: Screw connection, Color: green, Contact surface: Tin



Printed-circuit board connector - SMSTB 2,5/12-ST-5,08 - 1826380

Plug component, Nominal current: 12 A, Rated voltage (III/2): 320 V, Number of positions: 12, Pitch: 5.08 mm, Connection method: Screw connection, Color: green, Contact surface: Tin



Printed-circuit board connector - SMSTB 2,5/15-ST-5,08 - 1826416

Plug component, Nominal current: 12 A, Rated voltage (III/2): 320 V, Number of positions: 15, Pitch: 5.08 mm, Connection method: Screw connection, Color: green, Contact surface: Tin



Feed-through terminal block - UKK 3-MSTB-5,08 BU - 2770286

Accessories

Printed-circuit board connector - SMSTB 2,5/16-ST-5,08 - 1826429

Plug component, Nominal current: 12 A, Rated voltage (III/2): 320 V, Number of positions: 16, Pitch: 5.08 mm, Connection method: Screw connection, Color: green, Contact surface: Tin



Printed-circuit board connector - SMSTB 2,5/19-ST-5,08 - 1850589

Plug component, Nominal current: 12 A, Rated voltage (III/2): 320 V, Number of positions: 19, Pitch: 5.08 mm, Connection method: Screw connection, Color: green, Contact surface: Tin



Printed-circuit board connector - SMSTB 2,5/20-ST-5,08 - 1850592

Plug component, Nominal current: 12 A, Rated voltage (III/2): 320 V, Number of positions: 20, Pitch: 5.08 mm, Connection method: Screw connection, Color: green, Contact surface: Tin



Printed-circuit board connector - SMSTB 2,5/23-ST-5,08 - 1850628

Plug component, Nominal current: 12 A, Rated voltage (III/2): 320 V, Number of positions: 23, Pitch: 5.08 mm, Connection method: Screw connection, Color: green, Contact surface: Tin



Printed-circuit board connector - SMSTB 2,5/21-ST-5,08 - 1850602

Plug component, Nominal current: 12 A, Rated voltage (III/2): 320 V, Number of positions: 21, Pitch: 5.08 mm, Connection method: Screw connection, Color: green, Contact surface: Tin



Feed-through terminal block - UKK 3-MSTB-5,08 BU - 2770286

Accessories

Printed-circuit board connector - SMSTB 2,5/14-ST-5,08 - 1826403

Plug component, Nominal current: 12 A, Rated voltage (III/2): 320 V, Number of positions: 14, Pitch: 5.08 mm, Connection method: Screw connection, Color: green, Contact surface: Tin



Printed-circuit board connector - SMSTB 2,5/ 7-ST-5,08 - 1826335

Plug component, Nominal current: 12 A, Rated voltage (III/2): 320 V, Number of positions: 7, Pitch: 5.08 mm, Connection method: Screw connection, Color: green, Contact surface: Tin



Printed-circuit board connector - SMSTB 2,5/17-ST-5,08 - 1850563

Plug component, Nominal current: 12 A, Rated voltage (III/2): 320 V, Number of positions: 17, Pitch: 5.08 mm, Connection method: Screw connection, Color: green, Contact surface: Tin



Printed-circuit board connector - SMSTB 2,5/ 2-ST-5,08 - 1826283

Plug component, Nominal current: 12 A, Rated voltage (III/2): 320 V, Number of positions: 2, Pitch: 5.08 mm, Connection method: Screw connection, Color: green, Contact surface: Tin



Printed-circuit board connector - SMSTB 2,5/ 3-ST-5,08 - 1826296

Plug component, Nominal current: 12 A, Rated voltage (III/2): 320 V, Number of positions: 3, Pitch: 5.08 mm, Connection method: Screw connection, Color: green, Contact surface: Tin



Feed-through terminal block - UKK 3-MSTB-5,08 BU - 2770286

Accessories

Printed-circuit board connector - SMSTB 2,5/ 6-ST-5,08 - 1826322

Plug component, Nominal current: 12 A, Rated voltage (III/2): 320 V, Number of positions: 6, Pitch: 5.08 mm, Connection method: Screw connection, Color: green, Contact surface: Tin



Printed-circuit board connector - SMSTB 2,5/22-ST-5,08 - 1850615

Plug component, Nominal current: 12 A, Rated voltage (III/2): 320 V, Number of positions: 22, Pitch: 5.08 mm, Connection method: Screw connection, Color: green, Contact surface: Tin



Printed-circuit board connector - SMSTB 2,5/24-ST-5,08 - 1850631

Plug component, Nominal current: 12 A, Rated voltage (III/2): 320 V, Number of positions: 24, Pitch: 5.08 mm, Connection method: Screw connection, Color: green, Contact surface: Tin



Printed-circuit board connector - FRONT-MSTB 2,5/ 2-ST-5,08 - 1777280

Plug component, Nominal current: 12 A, Rated voltage (III/2): 320 V, Number of positions: 2, Pitch: 5.08 mm, Connection method: Screw connection, Color: green, Contact surface: Tin



Printed-circuit board connector - FRONT-MSTB 2,5/ 6-ST-5,08 - 1777329

Plug component, Nominal current: 12 A, Rated voltage (III/2): 320 V, Number of positions: 6, Pitch: 5.08 mm, Connection method: Screw connection, Color: green, Contact surface: Tin



Feed-through terminal block - UKK 3-MSTB-5,08 BU - 2770286

Accessories

Printed-circuit board connector - FRONT-MSTB 2,5/ 8-ST-5,08 - 1777345

Plug component, Nominal current: 12 A, Rated voltage (III/2): 320 V, Number of positions: 8, Pitch: 5.08 mm, Connection method: Screw connection, Color: green, Contact surface: Tin



Printed-circuit board connector - FRONT-MSTB 2,5/10-ST-5,08 - 1777361

Plug component, Nominal current: 12 A, Rated voltage (III/2): 320 V, Number of positions: 10, Pitch: 5.08 mm, Connection method: Screw connection, Color: green, Contact surface: Tin



Printed-circuit board connector - FRONT-MSTB 2,5/13-ST-5,08 - 1777390

Plug component, Nominal current: 12 A, Rated voltage (III/2): 320 V, Number of positions: 13, Pitch: 5.08 mm, Connection method: Screw connection, Color: green, Contact surface: Tin



Printed-circuit board connector - FRONT-MSTB 2,5/14-ST-5,08 - 1777400

Plug component, Nominal current: 12 A, Rated voltage (III/2): 320 V, Number of positions: 14, Pitch: 5.08 mm, Connection method: Screw connection, Color: green, Contact surface: Tin



Printed-circuit board connector - FRONT-MSTB 2,5/16-ST-5,08 - 1777426

Plug component, Nominal current: 12 A, Rated voltage (III/2): 320 V, Number of positions: 16, Pitch: 5.08 mm, Connection method: Screw connection, Color: green, Contact surface: Tin



Feed-through terminal block - UKK 3-MSTB-5,08 BU - 2770286

Accessories

Printed-circuit board connector - FRONT-MSTB 2,5/22-ST-5,08 - 1777484

Plug component, Nominal current: 12 A, Rated voltage (III/2): 320 V, Number of positions: 22, Pitch: 5.08 mm, Connection method: Screw connection, Color: green, Contact surface: Tin



Plug - FRONT-MSTB 2,5/24-ST-5,08 - 1777507

Plug component, Nominal current: 12 A, Rated voltage (III/2): 320 V, Number of positions: 24, Pitch: 5.08 mm, Connection method: Screw connection, Color: green, Contact surface: Tin



Printed-circuit board connector - FRONT-MSTB 2,5/11-ST-5,08 - 1777374

Plug component, Nominal current: 12 A, Rated voltage (III/2): 320 V, Number of positions: 11, Pitch: 5.08 mm, Connection method: Screw connection, Color: green, Contact surface: Tin



Printed-circuit board connector - FRONT-MSTB 2,5/17-ST-5,08 - 1777439

Plug component, Nominal current: 12 A, Rated voltage (III/2): 320 V, Number of positions: 17, Pitch: 5.08 mm, Connection method: Screw connection, Color: green, Contact surface: Tin



Printed-circuit board connector - FRONT-MSTB 2,5/ 3-ST-5,08 - 1777293

Plug component, Nominal current: 12 A, Rated voltage (III/2): 320 V, Number of positions: 3, Pitch: 5.08 mm, Connection method: Screw connection, Color: green, Contact surface: Tin



Feed-through terminal block - UKK 3-MSTB-5,08 BU - 2770286

Accessories

Printed-circuit board connector - FRONT-MSTB 2,5/19-ST-5,08 - 1777455

Plug component, Nominal current: 12 A, Rated voltage (III/2): 320 V, Number of positions: 19, Pitch: 5.08 mm, Connection method: Screw connection, Color: green, Contact surface: Tin



Printed-circuit board connector - FRONT-MSTB 2,5/21-ST-5,08 - 1777471

Plug component, Nominal current: 12 A, Rated voltage (III/2): 320 V, Number of positions: 21, Pitch: 5.08 mm, Connection method: Screw connection, Color: green, Contact surface: Tin



Printed-circuit board connector - FRONT-MSTB 2,5/15-ST-5,08 - 1777413

Plug component, Nominal current: 12 A, Rated voltage (III/2): 320 V, Number of positions: 15, Pitch: 5.08 mm, Connection method: Screw connection, Color: green, Contact surface: Tin



Printed-circuit board connector - FRONT-MSTB 2,5/ 4-ST-5,08 - 1777303

Plug component, Nominal current: 12 A, Rated voltage (III/2): 320 V, Number of positions: 4, Pitch: 5.08 mm, Connection method: Screw connection, Color: green, Contact surface: Tin



Printed-circuit board connector - FRONT-MSTB 2,5/ 5-ST-5,08 - 1777316

Plug component, Nominal current: 12 A, Rated voltage (III/2): 320 V, Number of positions: 5, Pitch: 5.08 mm, Connection method: Screw connection, Color: green, Contact surface: Tin



Feed-through terminal block - UKK 3-MSTB-5,08 BU - 2770286

Accessories

Printed-circuit board connector - FRONT-MSTB 2,5/ 9-ST-5,08 - 1777358

Plug component, Nominal current: 12 A, Rated voltage (III/2): 320 V, Number of positions: 9, Pitch: 5.08 mm, Connection method: Screw connection, Color: green, Contact surface: Tin



Printed-circuit board connector - FRONT-MSTB 2,5/12-ST-5,08 - 1777387

Plug component, Nominal current: 12 A, Rated voltage (III/2): 320 V, Number of positions: 12, Pitch: 5.08 mm, Connection method: Screw connection, Color: green, Contact surface: Tin



Printed-circuit board connector - FRONT-MSTB 2,5/18-ST-5,08 - 1777442

Plug component, Nominal current: 12 A, Rated voltage (III/2): 320 V, Number of positions: 18, Pitch: 5.08 mm, Connection method: Screw connection, Color: green, Contact surface: Tin



Printed-circuit board connector - FRONT-MSTB 2,5/20-ST-5,08 - 1777468

Plug component, Nominal current: 12 A, Rated voltage (III/2): 320 V, Number of positions: 20, Pitch: 5.08 mm, Connection method: Screw connection, Color: green, Contact surface: Tin



Printed-circuit board connector - FRONT-MSTB 2,5/23-ST-5,08 - 1777497

Plug component, Nominal current: 12 A, Rated voltage (III/2): 320 V, Number of positions: 23, Pitch: 5.08 mm, Connection method: Screw connection, Color: green, Contact surface: Tin



Feed-through terminal block - UKK 3-MSTB-5,08 BU - 2770286

Accessories

Printed-circuit board connector - FRONT-MSTB 2,5/ 8-STF-5,08 - 1777798

Plug component, Nominal current: 12 A, Rated voltage (III/2): 320 V, Number of positions: 8, Pitch: 5.08 mm, Connection method: Screw connection, Color: green, Contact surface: Tin



Printed-circuit board connector - FRONT-MSTB 2,5/ 5-STF-5,08 - 1777837

Plug component, Nominal current: 12 A, Rated voltage (III/2): 320 V, Number of positions: 5, Pitch: 5.08 mm, Connection method: Screw connection, Color: green, Contact surface: Tin



Printed-circuit board connector - FRONT-MSTB 2,5/ 6-STF-5,08 - 1777840

Plug component, Nominal current: 12 A, Rated voltage (III/2): 320 V, Number of positions: 6, Pitch: 5.08 mm, Connection method: Screw connection, Color: green, Contact surface: Tin



Printed-circuit board connector - FRONT-MSTB 2,5/ 9-STF-5,08 - 1777866

Plug component, Nominal current: 12 A, Rated voltage (III/2): 320 V, Number of positions: 9, Pitch: 5.08 mm, Connection method: Screw connection, Color: green, Contact surface: Tin



Printed-circuit board connector - FRONT-MSTB 2,5/11-STF-5,08 - 1777882

Plug component, Nominal current: 12 A, Rated voltage (III/2): 320 V, Number of positions: 11, Pitch: 5.08 mm, Connection method: Screw connection, Color: green, Contact surface: Tin



Feed-through terminal block - UKK 3-MSTB-5,08 BU - 2770286

Accessories

Printed-circuit board connector - FRONT-MSTB 2,5/12-STF-5,08 - 1777895

Plug component, Nominal current: 12 A, Rated voltage (III/2): 320 V, Number of positions: 12, Pitch: 5.08 mm, Connection method: Screw connection, Color: green, Contact surface: Tin



Printed-circuit board connector - FRONT-MSTB 2,5/13-STF-5,08 - 1777905

Plug component, Nominal current: 12 A, Rated voltage (III/2): 320 V, Number of positions: 13, Pitch: 5.08 mm, Connection method: Screw connection, Color: green, Contact surface: Tin



Printed-circuit board connector - FRONT-MSTB 2,5/16-STF-5,08 - 1777934

Plug component, Nominal current: 12 A, Rated voltage (III/2): 320 V, Number of positions: 16, Pitch: 5.08 mm, Connection method: Screw connection, Color: green, Contact surface: Tin



Printed-circuit board connector - FRONT-MSTB 2,5/20-STF-5,08 - 1777976

Plug component, Nominal current: 12 A, Rated voltage (III/2): 320 V, Number of positions: 20, Pitch: 5.08 mm, Connection method: Screw connection, Color: green, Contact surface: Tin



Printed-circuit board connector - FRONT-MSTB 2,5/ 3-STF-5,08 - 1777811

Plug component, Nominal current: 12 A, Rated voltage (III/2): 320 V, Number of positions: 3, Pitch: 5.08 mm, Connection method: Screw connection, Color: green, Contact surface: Tin



Feed-through terminal block - UKK 3-MSTB-5,08 BU - 2770286

Accessories

Printed-circuit board connector - FRONT-MSTB 2,5/18-STF-5,08 - 1777950

Plug component, Nominal current: 12 A, Rated voltage (III/2): 320 V, Number of positions: 18, Pitch: 5.08 mm, Connection method: Screw connection, Color: green, Contact surface: Tin



Printed-circuit board connector - FRONT-MSTB 2,5/ 7-STF-5,08 - 1777853

Plug component, Nominal current: 12 A, Rated voltage (III/2): 320 V, Number of positions: 7, Pitch: 5.08 mm, Connection method: Screw connection, Color: green, Contact surface: Tin



Printed-circuit board connector - FRONT-MSTB 2,5/19-STF-5,08 - 1777963

Plug component, Nominal current: 12 A, Rated voltage (III/2): 320 V, Number of positions: 19, Pitch: 5.08 mm, Connection method: Screw connection, Color: green, Contact surface: Tin



Printed-circuit board connector - FRONT-MSTB 2,5/17-STF-5,08 - 1777947

Plug component, Nominal current: 12 A, Rated voltage (III/2): 320 V, Number of positions: 17, Pitch: 5.08 mm, Connection method: Screw connection, Color: green, Contact surface: Tin



Printed-circuit board connector - FRONT-MSTB 2,5/14-STF-5,08 - 1777918

Plug component, Nominal current: 12 A, Rated voltage (III/2): 320 V, Number of positions: 14, Pitch: 5.08 mm, Connection method: Screw connection, Color: green, Contact surface: Tin



Feed-through terminal block - UKK 3-MSTB-5,08 BU - 2770286

Accessories

Printed-circuit board connector - FRONT-MSTB 2,5/ 4-STF-5,08 - 1777824

Plug component, Nominal current: 12 A, Rated voltage (III/2): 320 V, Number of positions: 4, Pitch: 5.08 mm, Connection method: Screw connection, Color: green, Contact surface: Tin



Printed-circuit board connector - FRONT-MSTB 2,5/10-STF-5,08 - 1777879

Plug component, Nominal current: 12 A, Rated voltage (III/2): 320 V, Number of positions: 10, Pitch: 5.08 mm, Connection method: Screw connection, Color: green, Contact surface: Tin



Printed-circuit board connector - FRONT-MSTB 2,5/15-STF-5,08 - 1777921

Plug component, Nominal current: 12 A, Rated voltage (III/2): 320 V, Number of positions: 15, Pitch: 5.08 mm, Connection method: Screw connection, Color: green, Contact surface: Tin



Printed-circuit board connector - FRONT-MSTB 2,5/ 2-STF-5,08 - 1777808

Plug component, Nominal current: 12 A, Rated voltage (III/2): 320 V, Number of positions: 2, Pitch: 5.08 mm, Connection method: Screw connection, Color: green, Contact surface: Tin



Printed-circuit board connector - FKC 2,5/ 4-ST-5,08 - 1873074

Plug component, Nominal current: 12 A, Rated voltage (III/2): 320 V, Number of positions: 4, Pitch: 5.08 mm, Connection method: Spring-cage conn., Color: green, Contact surface: Tin



Feed-through terminal block - UKK 3-MSTB-5,08 BU - 2770286

Accessories

Printed-circuit board connector - FKC 2,5/ 5-ST-5,08 - 1873087

Plug component, Nominal current: 12 A, Rated voltage (III/2): 320 V, Number of positions: 5, Pitch: 5.08 mm, Connection method: Spring-cage conn., Color: green, Contact surface: Tin



Printed-circuit board connector - FKC 2,5/ 7-ST-5,08 - 1873100

Plug component, Nominal current: 12 A, Rated voltage (III/2): 320 V, Number of positions: 7, Pitch: 5.08 mm, Connection method: Spring-cage conn., Color: green, Contact surface: Tin



Printed-circuit board connector - FKC 2,5/ 8-ST-5,08 - 1873113

Plug component, Nominal current: 12 A, Rated voltage (III/2): 320 V, Number of positions: 8, Pitch: 5.08 mm, Connection method: Spring-cage conn., Color: green, Contact surface: Tin



Printed-circuit board connector - FKC 2,5/10-ST-5,08 - 1873139

Plug component, Nominal current: 12 A, Rated voltage (III/2): 320 V, Number of positions: 10, Pitch: 5.08 mm, Connection method: Spring-cage conn., Color: green, Contact surface: Tin



Printed-circuit board connector - FKC 2,5/12-ST-5,08 - 1873155

Plug component, Nominal current: 12 A, Rated voltage (III/2): 320 V, Number of positions: 12, Pitch: 5.08 mm, Connection method: Spring-cage conn., Color: green, Contact surface: Tin



Feed-through terminal block - UKK 3-MSTB-5,08 BU - 2770286

Accessories

Printed-circuit board connector - FKC 2,5/13-ST-5,08 - 1873168

Plug component, Nominal current: 12 A, Rated voltage (III/2): 320 V, Number of positions: 13, Pitch: 5.08 mm, Connection method: Spring-cage conn., Color: green, Contact surface: Tin



Printed-circuit board connector - FKC 2,5/16-ST-5,08 - 1873197

Plug component, Nominal current: 12 A, Rated voltage (III/2): 320 V, Number of positions: 16, Pitch: 5.08 mm, Connection method: Spring-cage conn., Color: green, Contact surface: Tin



Printed-circuit board connector - FKC 2,5/ 3-ST-5,08 - 1873061

Plug component, Nominal current: 12 A, Rated voltage (III/2): 320 V, Number of positions: 3, Pitch: 5.08 mm, Connection method: Spring-cage conn., Color: green, Contact surface: Tin



Printed-circuit board connector - FKC 2,5/ 9-ST-5,08 - 1873126

Plug component, Nominal current: 12 A, Rated voltage (III/2): 320 V, Number of positions: 9, Pitch: 5.08 mm, Connection method: Spring-cage conn., Color: green, Contact surface: Tin



Printed-circuit board connector - FKC 2,5/14-ST-5,08 - 1873171

Plug component, Nominal current: 12 A, Rated voltage (III/2): 320 V, Number of positions: 14, Pitch: 5.08 mm, Connection method: Spring-cage conn., Color: green, Contact surface: Tin



Feed-through terminal block - UKK 3-MSTB-5,08 BU - 2770286

Accessories

Printed-circuit board connector - FKC 2,5/ 6-ST-5,08 - 1873090

Plug component, Nominal current: 12 A, Rated voltage (III/2): 320 V, Number of positions: 6, Pitch: 5.08 mm, Connection method: Spring-cage conn., Color: green, Contact surface: Tin



Printed-circuit board connector - FKC 2,5/11-ST-5,08 - 1873142

Plug component, Nominal current: 12 A, Rated voltage (III/2): 320 V, Number of positions: 11, Pitch: 5.08 mm, Connection method: Spring-cage conn., Color: green, Contact surface: Tin



Printed-circuit board connector - FKC 2,5/15-ST-5,08 - 1873184

Plug component, Nominal current: 12 A, Rated voltage (III/2): 320 V, Number of positions: 15, Pitch: 5.08 mm, Connection method: Spring-cage conn., Color: green, Contact surface: Tin



Printed-circuit board connector - FKC 2,5/ 2-ST-5,08 - 1873058

Plug component, Nominal current: 12 A, Rated voltage (III/2): 320 V, Number of positions: 2, Pitch: 5.08 mm, Connection method: Spring-cage conn., Color: green, Contact surface: Tin



Printed-circuit board connector - QC 1/ 2-ST-5,08 - 1883255

Plug component, Nominal current: 10 A, Rated voltage (III/2): 630 V, Number of positions: 2, Pitch: 5.08 mm, Connection method: Insulation displacement connection QUICKON, Color: green, Contact surface: Tin

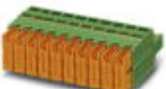

Feed-through terminal block - UKK 3-MSTB-5,08 BU - 2770286

Accessories

Printed-circuit board connector - QC 1/ 5-ST-5,08 - 1883284



Plug component, Nominal current: 10 A, Rated voltage (III/2): 630 V, Number of positions: 5, Pitch: 5.08 mm, Connection method: Insulation displacement connection QUICKON, Color: green, Contact surface: Tin

Printed-circuit board connector - QC 1/ 6-ST-5,08 - 1883297



Plug component, Nominal current: 10 A, Rated voltage (III/2): 630 V, Number of positions: 6, Pitch: 5.08 mm, Connection method: Insulation displacement connection QUICKON, Color: green, Contact surface: Tin

Printed-circuit board connector - QC 1/ 8-ST-5,08 - 1883310



Plug component, Nominal current: 10 A, Rated voltage (III/2): 630 V, Number of positions: 8, Pitch: 5.08 mm, Connection method: Insulation displacement connection QUICKON, Color: green, Contact surface: Tin

Printed-circuit board connector - QC 1/12-ST-5,08 - 1883705



Plug component, Nominal current: 10 A, Rated voltage (III/2): 630 V, Number of positions: 12, Pitch: 5.08 mm, Connection method: Insulation displacement connection QUICKON, Color: green, Contact surface: Tin

Printed-circuit board connector - QC 1/15-ST-5,08 - 1883831

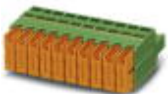

Plug component, Nominal current: 10 A, Rated voltage (III/2): 630 V, Number of positions: 15, Pitch: 5.08 mm, Connection method: Insulation displacement connection QUICKON, Color: green, Contact surface: Tin

Feed-through terminal block - UKK 3-MSTB-5,08 BU - 2770286

Accessories

Printed-circuit board connector - QC 1/16-ST-5,08 - 1883844

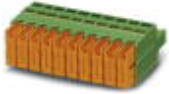

Plug component, Nominal current: 10 A, Rated voltage (III/2): 630 V, Number of positions: 16, Pitch: 5.08 mm, Connection method: Insulation displacement connection QUICKON, Color: green, Contact surface: Tin

Printed-circuit board connector - QC 1/13-ST-5,08 - 1883815



Plug component, Nominal current: 10 A, Rated voltage (III/2): 630 V, Number of positions: 13, Pitch: 5.08 mm, Connection method: Insulation displacement connection QUICKON, Color: green, Contact surface: Tin

Printed-circuit board connector - QC 1/10-ST-5,08 - 1883336



Plug component, Nominal current: 10 A, Rated voltage (III/2): 630 V, Number of positions: 10, Pitch: 5.08 mm, Connection method: Insulation displacement connection QUICKON, Color: green, Contact surface: Tin

Printed-circuit board connector - QC 1/14-ST-5,08 - 1883828



Plug component, Nominal current: 10 A, Rated voltage (III/2): 630 V, Number of positions: 14, Pitch: 5.08 mm, Connection method: Insulation displacement connection QUICKON, Color: green, Contact surface: Tin

Printed-circuit board connector - QC 1/ 9-ST-5,08 - 1883323

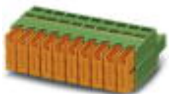

Plug component, Nominal current: 10 A, Rated voltage (III/2): 630 V, Number of positions: 9, Pitch: 5.08 mm, Connection method: Insulation displacement connection QUICKON, Color: green, Contact surface: Tin

Feed-through terminal block - UKK 3-MSTB-5,08 BU - 2770286

Accessories

Printed-circuit board connector - QC 1/11-ST-5,08 - 1883349



Plug component, Nominal current: 10 A, Rated voltage (III/2): 630 V, Number of positions: 11, Pitch: 5.08 mm, Connection method: Insulation displacement connection QUICKON, Color: green, Contact surface: Tin

Printed-circuit board connector - QC 1/ 7-ST-5,08 - 1883307



Plug component, Nominal current: 10 A, Rated voltage (III/2): 630 V, Number of positions: 7, Pitch: 5.08 mm, Connection method: Insulation displacement connection QUICKON, Color: green, Contact surface: Tin

Printed-circuit board connector - QC 1/ 4-ST-5,08 - 1883271



Plug component, Nominal current: 10 A, Rated voltage (III/2): 630 V, Number of positions: 4, Pitch: 5.08 mm, Connection method: Insulation displacement connection QUICKON, Color: green, Contact surface: Tin

Printed-circuit board connector - QC 1/ 3-ST-5,08 - 1883268



Plug component, Nominal current: 10 A, Rated voltage (III/2): 630 V, Number of positions: 3, Pitch: 5.08 mm, Connection method: Insulation displacement connection QUICKON, Color: green, Contact surface: Tin

Printed-circuit board connector - MSTBC 2,5/ 5-ST-5,08 - 1808845



Plug component, Nominal current: 12 A, Rated voltage (III/2): 320 V, Number of positions: 5, Pitch: 5.08 mm, Connection method: Crimp connection, Color: green, Corresponding female crimp contacts with current [A] and conductor cross section range [mm²] data: 10A/MSTBC-MT 0,5-1,0 (3190564); 10A/MSTBC-MT 0,5-1,0 BA (3190645); 12A/MSTBC-MT 1,5-2,5 (3190551); 12A/MSTBC-MT 1,5-2,5 BA (3190658). BA = Bandkontakte

Feed-through terminal block - UKK 3-MSTB-5,08 BU - 2770286

Accessories

Printed-circuit board connector - MSTBC 2,5/ 6-ST-5,08 - 1808858



Plug component, Nominal current: 12 A, Rated voltage (III/2): 320 V, Number of positions: 6, Pitch: 5.08 mm, Connection method: Crimp connection, Color: green, Corresponding female crimp contacts with current [A] and conductor cross section range [mm²] data: 10A/MSTBC-MT 0,5-1,0 (3190564); 10A/MSTBC-MT 0,5-1,0 BA (3190645); 12A/MSTBC-MT 1,5-2,5 (3190551); 12A/MSTBC-MT 1,5-2,5 BA (3190658). BA = Bandkontakte

Printed-circuit board connector - MSTBC 2,5/ 8-ST-5,08 - 1808874



Plug component, Nominal current: 12 A, Rated voltage (III/2): 320 V, Number of positions: 8, Pitch: 5.08 mm, Connection method: Crimp connection, Color: green, Corresponding female crimp contacts with current [A] and conductor cross section range [mm²] data: 10A/MSTBC-MT 0,5-1,0 (3190564); 10A/MSTBC-MT 0,5-1,0 BA (3190645); 12A/MSTBC-MT 1,5-2,5 (3190551); 12A/MSTBC-MT 1,5-2,5 BA (3190658). BA = Bandkontakte

Printed-circuit board connector - MSTBC 2,5/13-ST-5,08 - 1808926



Plug component, Nominal current: 12 A, Rated voltage (III/2): 320 V, Number of positions: 13, Pitch: 5.08 mm, Connection method: Crimp connection, Color: green, Corresponding female crimp contacts with current [A] and conductor cross section range [mm²] data: 10A/MSTBC-MT 0,5-1,0 (3190564); 10A/MSTBC-MT 0,5-1,0 BA (3190645); 12A/MSTBC-MT 1,5-2,5 (3190551); 12A/MSTBC-MT 1,5-2,5 BA (3190658). BA = Bandkontakte

Printed-circuit board connector - MSTBC 2,5/14-ST-5,08 - 1808939



Plug component, Nominal current: 12 A, Rated voltage (III/2): 320 V, Number of positions: 14, Pitch: 5.08 mm, Connection method: Crimp connection, Color: green, Corresponding female crimp contacts with current [A] and conductor cross section range [mm²] data: 10A/MSTBC-MT 0,5-1,0 (3190564); 10A/MSTBC-MT 0,5-1,0 BA (3190645); 12A/MSTBC-MT 1,5-2,5 (3190551); 12A/MSTBC-MT 1,5-2,5 BA (3190658). BA = Bandkontakte

Printed-circuit board connector - MSTBC 2,5/15-ST-5,08 - 1808942



Plug component, Nominal current: 12 A, Rated voltage (III/2): 320 V, Number of positions: 15, Pitch: 5.08 mm, Connection method: Crimp connection, Color: green, Corresponding female crimp contacts with current [A] and conductor cross section range [mm²] data: 10A/MSTBC-MT 0,5-1,0 (3190564); 10A/MSTBC-MT 0,5-1,0 BA (3190645); 12A/MSTBC-MT 1,5-2,5 (3190551); 12A/MSTBC-MT 1,5-2,5 BA (3190658). BA = Bandkontakte

Feed-through terminal block - UKK 3-MSTB-5,08 BU - 2770286

Accessories

Printed-circuit board connector - MSTBC 2,5/19-ST-5,08 - 1808984



Plug component, Nominal current: 12 A, Rated voltage (III/2): 320 V, Number of positions: 19, Pitch: 5.08 mm, Connection method: Crimp connection, Color: green, Corresponding female crimp contacts with current [A] and conductor cross section range [mm²] data: 10A/MSTBC-MT 0,5-1,0 (3190564); 10A/MSTBC-MT 0,5-1,0 BA (3190645); 12A/MSTBC-MT 1,5-2,5 (3190551); 12A/MSTBC-MT 1,5-2,5 BA (3190658). BA = Bandkontakte

Printed-circuit board connector - MSTBC 2,5/20-ST-5,08 - 1808997



Plug component, Nominal current: 12 A, Rated voltage (III/2): 320 V, Number of positions: 20, Pitch: 5.08 mm, Connection method: Crimp connection, Color: green, Corresponding female crimp contacts with current [A] and conductor cross section range [mm²] data: 10A/MSTBC-MT 0,5-1,0 (3190564); 10A/MSTBC-MT 0,5-1,0 BA (3190645); 12A/MSTBC-MT 1,5-2,5 (3190551); 12A/MSTBC-MT 1,5-2,5 BA (3190658). BA = Bandkontakte

Printed-circuit board connector - MSTBC 2,5/12-ST-5,08 - 1808913



Plug component, Nominal current: 12 A, Rated voltage (III/2): 320 V, Number of positions: 12, Pitch: 5.08 mm, Connection method: Crimp connection, Color: green, Corresponding female crimp contacts with current [A] and conductor cross section range [mm²] data: 10A/MSTBC-MT 0,5-1,0 (3190564); 10A/MSTBC-MT 0,5-1,0 BA (3190645); 12A/MSTBC-MT 1,5-2,5 (3190551); 12A/MSTBC-MT 1,5-2,5 BA (3190658). BA = Bandkontakte

Printed-circuit board connector - MSTBC 2,5/18-ST-5,08 - 1808971



Plug component, Nominal current: 12 A, Rated voltage (III/2): 320 V, Number of positions: 18, Pitch: 5.08 mm, Connection method: Crimp connection, Color: green, Corresponding female crimp contacts with current [A] and conductor cross section range [mm²] data: 10A/MSTBC-MT 0,5-1,0 (3190564); 10A/MSTBC-MT 0,5-1,0 BA (3190645); 12A/MSTBC-MT 1,5-2,5 (3190551); 12A/MSTBC-MT 1,5-2,5 BA (3190658). BA = Bandkontakte

Printed-circuit board connector - MSTBC 2,5/ 3-ST-5,08 - 1808829



Plug component, Nominal current: 12 A, Rated voltage (III/2): 320 V, Number of positions: 3, Pitch: 5.08 mm, Connection method: Crimp connection, Color: green, Corresponding female crimp contacts with current [A] and conductor cross section range [mm²] data: 10A/MSTBC-MT 0,5-1,0 (3190564); 10A/MSTBC-MT 0,5-1,0 BA (3190645); 12A/MSTBC-MT 1,5-2,5 (3190551); 12A/MSTBC-MT 1,5-2,5 BA (3190658). BA = Bandkontakte

Feed-through terminal block - UKK 3-MSTB-5,08 BU - 2770286

Accessories

Printed-circuit board connector - MSTBC 2,5/22-ST-5,08 - 1809019



Plug component, Nominal current: 12 A, Rated voltage (III/2): 320 V, Number of positions: 22, Pitch: 5.08 mm, Connection method: Crimp connection, Color: green, Corresponding female crimp contacts with current [A] and conductor cross section range [mm²] data: 10A/MSTBC-MT 0,5-1,0 (3190564); 10A/MSTBC-MT 0,5-1,0 BA (3190645); 12A/MSTBC-MT 1,5-2,5 (3190551); 12A/MSTBC-MT 1,5-2,5 BA (3190658). BA = Bandkontakte

Printed-circuit board connector - MSTBC 2,5/ 7-ST-5,08 - 1808861



Plug component, Nominal current: 12 A, Rated voltage (III/2): 320 V, Number of positions: 7, Pitch: 5.08 mm, Connection method: Crimp connection, Color: green, Corresponding female crimp contacts with current [A] and conductor cross section range [mm²] data: 10A/MSTBC-MT 0,5-1,0 (3190564); 10A/MSTBC-MT 0,5-1,0 BA (3190645); 12A/MSTBC-MT 1,5-2,5 (3190551); 12A/MSTBC-MT 1,5-2,5 BA (3190658). BA = Bandkontakte

Printed-circuit board connector - MSTBC 2,5/ 9-ST-5,08 - 1808887



Plug component, Nominal current: 12 A, Rated voltage (III/2): 320 V, Number of positions: 9, Pitch: 5.08 mm, Connection method: Crimp connection, Color: green, Corresponding female crimp contacts with current [A] and conductor cross section range [mm²] data: 10A/MSTBC-MT 0,5-1,0 (3190564); 10A/MSTBC-MT 0,5-1,0 BA (3190645); 12A/MSTBC-MT 1,5-2,5 (3190551); 12A/MSTBC-MT 1,5-2,5 BA (3190658). BA = Bandkontakte

Printed-circuit board connector - MSTBC 2,5/23-ST-5,08 - 1809022



Plug component, Nominal current: 12 A, Rated voltage (III/2): 320 V, Number of positions: 23, Pitch: 5.08 mm, Connection method: Crimp connection, Color: green, Corresponding female crimp contacts with current [A] and conductor cross section range [mm²] data: 10A/MSTBC-MT 0,5-1,0 (3190564); 10A/MSTBC-MT 0,5-1,0 BA (3190645); 12A/MSTBC-MT 1,5-2,5 (3190551); 12A/MSTBC-MT 1,5-2,5 BA (3190658). BA = Bandkontakte

Printed-circuit board connector - MSTBC 2,5/10-ST-5,08 - 1808890



Plug component, Nominal current: 12 A, Rated voltage (III/2): 320 V, Number of positions: 10, Pitch: 5.08 mm, Connection method: Crimp connection, Color: green, Corresponding female crimp contacts with current [A] and conductor cross section range [mm²] data: 10A/MSTBC-MT 0,5-1,0 (3190564); 10A/MSTBC-MT 0,5-1,0 BA (3190645); 12A/MSTBC-MT 1,5-2,5 (3190551); 12A/MSTBC-MT 1,5-2,5 BA (3190658). BA = Bandkontakte

Feed-through terminal block - UKK 3-MSTB-5,08 BU - 2770286

Accessories

Printed-circuit board connector - MSTBC 2,5/ 2-ST-5,08 - 1808816



Plug component, Nominal current: 12 A, Rated voltage (III/2): 320 V, Number of positions: 2, Pitch: 5.08 mm, Connection method: Crimp connection, Color: green, Corresponding female crimp contacts with current [A] and conductor cross section range [mm²] data: 10A/MSTBC-MT 0,5-1,0 (3190564); 10A/MSTBC-MT 0,5-1,0 BA (3190645); 12A/MSTBC-MT 1,5-2,5 (3190551); 12A/MSTBC-MT 1,5-2,5 BA (3190658). BA = Bandkontakte

Printed-circuit board connector - MSTBC 2,5/ 4-ST-5,08 - 1808832



Plug component, Nominal current: 12 A, Rated voltage (III/2): 320 V, Number of positions: 4, Pitch: 5.08 mm, Connection method: Crimp connection, Color: green, Corresponding female crimp contacts with current [A] and conductor cross section range [mm²] data: 10A/MSTBC-MT 0,5-1,0 (3190564); 10A/MSTBC-MT 0,5-1,0 BA (3190645); 12A/MSTBC-MT 1,5-2,5 (3190551); 12A/MSTBC-MT 1,5-2,5 BA (3190658). BA = Bandkontakte

Printed-circuit board connector - MSTBC 2,5/11-ST-5,08 - 1808900



Plug component, Nominal current: 12 A, Rated voltage (III/2): 320 V, Number of positions: 11, Pitch: 5.08 mm, Connection method: Crimp connection, Color: green, Corresponding female crimp contacts with current [A] and conductor cross section range [mm²] data: 10A/MSTBC-MT 0,5-1,0 (3190564); 10A/MSTBC-MT 0,5-1,0 BA (3190645); 12A/MSTBC-MT 1,5-2,5 (3190551); 12A/MSTBC-MT 1,5-2,5 BA (3190658). BA = Bandkontakte

Printed-circuit board connector - MSTBC 2,5/16-ST-5,08 - 1808955



Plug component, Nominal current: 12 A, Rated voltage (III/2): 320 V, Number of positions: 16, Pitch: 5.08 mm, Connection method: Crimp connection, Color: green, Corresponding female crimp contacts with current [A] and conductor cross section range [mm²] data: 10A/MSTBC-MT 0,5-1,0 (3190564); 10A/MSTBC-MT 0,5-1,0 BA (3190645); 12A/MSTBC-MT 1,5-2,5 (3190551); 12A/MSTBC-MT 1,5-2,5 BA (3190658). BA = Bandkontakte

Printed-circuit board connector - MSTBC 2,5/17-ST-5,08 - 1808968



Plug component, Nominal current: 12 A, Rated voltage (III/2): 320 V, Number of positions: 17, Pitch: 5.08 mm, Connection method: Crimp connection, Color: green, Corresponding female crimp contacts with current [A] and conductor cross section range [mm²] data: 10A/MSTBC-MT 0,5-1,0 (3190564); 10A/MSTBC-MT 0,5-1,0 BA (3190645); 12A/MSTBC-MT 1,5-2,5 (3190551); 12A/MSTBC-MT 1,5-2,5 BA (3190658). BA = Bandkontakte

Feed-through terminal block - UKK 3-MSTB-5,08 BU - 2770286

Accessories

Printed-circuit board connector - MSTBC 2,5/24-ST-5,08 - 1809035



Plug component, Nominal current: 12 A, Rated voltage (III/2): 320 V, Number of positions: 24, Pitch: 5.08 mm, Connection method: Crimp connection, Color: green, Corresponding female crimp contacts with current [A] and conductor cross section range [mm²] data: 10A/MSTBC-MT 0,5-1,0 (3190564); 10A/MSTBC-MT 0,5-1,0 BA (3190645); 12A/MSTBC-MT 1,5-2,5 (3190551); 12A/MSTBC-MT 1,5-2,5 BA (3190658). BA = Bandkontakte

Printed-circuit board connector - MSTBC 2,5/21-ST-5,08 - 1809006



Plug component, Nominal current: 12 A, Rated voltage (III/2): 320 V, Number of positions: 21, Pitch: 5.08 mm, Connection method: Crimp connection, Color: green, Corresponding female crimp contacts with current [A] and conductor cross section range [mm²] data: 10A/MSTBC-MT 0,5-1,0 (3190564); 10A/MSTBC-MT 0,5-1,0 BA (3190645); 12A/MSTBC-MT 1,5-2,5 (3190551); 12A/MSTBC-MT 1,5-2,5 BA (3190658). BA = Bandkontakte

Printed-circuit board connector - MSTBC 2,5/ 2-STZ-5,08 - 1809501



Plug component, Nominal current: 12 A, Rated voltage (III/2): 320 V, Number of positions: 2, Pitch: 5.08 mm, Connection method: Crimp connection, Color: green, Corresponding female crimp contacts with current [A] and conductor cross section range [mm²] data: 10A/MSTBC-MT 0,5-1,0 (3190564); 10A/MSTBC-MT 0,5-1,0 BA (3190645); 12A/MSTBC-MT 1,5-2,5 (3190551); 12A/MSTBC-MT 1,5-2,5 BA (3190658). BA = Bandkontakte

Printed-circuit board connector - MSTBC 2,5/ 5-STZ-5,08 - 1809530



Plug component, Nominal current: 12 A, Rated voltage (III/2): 320 V, Number of positions: 5, Pitch: 5.08 mm, Connection method: Crimp connection, Color: green, Corresponding female crimp contacts with current [A] and conductor cross section range [mm²] data: 10A/MSTBC-MT 0,5-1,0 (3190564); 10A/MSTBC-MT 0,5-1,0 BA (3190645); 12A/MSTBC-MT 1,5-2,5 (3190551); 12A/MSTBC-MT 1,5-2,5 BA (3190658). BA = Bandkontakte

Printed-circuit board connector - MSTBC 2,5/ 6-STZ-5,08 - 1809543



Plug component, Nominal current: 12 A, Rated voltage (III/2): 320 V, Number of positions: 6, Pitch: 5.08 mm, Connection method: Crimp connection, Color: green, Corresponding female crimp contacts with current [A] and conductor cross section range [mm²] data: 10A/MSTBC-MT 0,5-1,0 (3190564); 10A/MSTBC-MT 0,5-1,0 BA (3190645); 12A/MSTBC-MT 1,5-2,5 (3190551); 12A/MSTBC-MT 1,5-2,5 BA (3190658). BA = Bandkontakte

Feed-through terminal block - UKK 3-MSTB-5,08 BU - 2770286

Accessories

Printed-circuit board connector - MSTBC 2,5/ 9-STZ-5,08 - 1809572



Plug component, Nominal current: 12 A, Rated voltage (III/2): 320 V, Number of positions: 9, Pitch: 5.08 mm, Connection method: Crimp connection, Color: green, Corresponding female crimp contacts with current [A] and conductor cross section range [mm²] data: 10A/MSTBC-MT 0,5-1,0 (3190564); 10A/MSTBC-MT 0,5-1,0 BA (3190645); 12A/MSTBC-MT 1,5-2,5 (3190551); 12A/MSTBC-MT 1,5-2,5 BA (3190658). BA = Bandkontakte

Printed-circuit board connector - MSTBC 2,5/13-STZ-5,08 - 1809611



Plug component, Nominal current: 12 A, Rated voltage (III/2): 320 V, Number of positions: 13, Pitch: 5.08 mm, Connection method: Crimp connection, Color: green, Corresponding female crimp contacts with current [A] and conductor cross section range [mm²] data: 10A/MSTBC-MT 0,5-1,0 (3190564); 10A/MSTBC-MT 0,5-1,0 BA (3190645); 12A/MSTBC-MT 1,5-2,5 (3190551); 12A/MSTBC-MT 1,5-2,5 BA (3190658). BA = Bandkontakte

Printed-circuit board connector - MSTBC 2,5/15-STZ-5,08 - 1809637



Plug component, Nominal current: 12 A, Rated voltage (III/2): 320 V, Number of positions: 15, Pitch: 5.08 mm, Connection method: Crimp connection, Color: green, Corresponding female crimp contacts with current [A] and conductor cross section range [mm²] data: 10A/MSTBC-MT 0,5-1,0 (3190564); 10A/MSTBC-MT 0,5-1,0 BA (3190645); 12A/MSTBC-MT 1,5-2,5 (3190551); 12A/MSTBC-MT 1,5-2,5 BA (3190658). BA = Bandkontakte

Printed-circuit board connector - MSTBC 2,5/16-STZ-5,08 - 1809640



Plug component, Nominal current: 12 A, Rated voltage (III/2): 320 V, Number of positions: 16, Pitch: 5.08 mm, Connection method: Crimp connection, Color: green, Corresponding female crimp contacts with current [A] and conductor cross section range [mm²] data: 10A/MSTBC-MT 0,5-1,0 (3190564); 10A/MSTBC-MT 0,5-1,0 BA (3190645); 12A/MSTBC-MT 1,5-2,5 (3190551); 12A/MSTBC-MT 1,5-2,5 BA (3190658). BA = Bandkontakte

Printed-circuit board connector - MSTBC 2,5/19-STZ-5,08 - 1809679



Plug component, Nominal current: 12 A, Rated voltage (III/2): 320 V, Number of positions: 19, Pitch: 5.08 mm, Connection method: Crimp connection, Color: green, Corresponding female crimp contacts with current [A] and conductor cross section range [mm²] data: 10A/MSTBC-MT 0,5-1,0 (3190564); 10A/MSTBC-MT 0,5-1,0 BA (3190645); 12A/MSTBC-MT 1,5-2,5 (3190551); 12A/MSTBC-MT 1,5-2,5 BA (3190658). BA = Bandkontakte

Feed-through terminal block - UKK 3-MSTB-5,08 BU - 2770286

Accessories

Printed-circuit board connector - MSTBC 2,5/21-STZ-5,08 - 1809695



Plug component, Nominal current: 12 A, Rated voltage (III/2): 320 V, Number of positions: 21, Pitch: 5.08 mm, Connection method: Crimp connection, Color: green, Corresponding female crimp contacts with current [A] and conductor cross section range [mm²] data: 10A/MSTBC-MT 0,5-1,0 (3190564); 10A/MSTBC-MT 0,5-1,0 BA (3190645); 12A/MSTBC-MT 1,5-2,5 (3190551); 12A/MSTBC-MT 1,5-2,5 BA (3190658). BA = Bandkontakte

Printed-circuit board connector - MSTBC 2,5/22-STZ-5,08 - 1809705



Plug component, Nominal current: 12 A, Rated voltage (III/2): 320 V, Number of positions: 22, Pitch: 5.08 mm, Connection method: Crimp connection, Color: green, Corresponding female crimp contacts with current [A] and conductor cross section range [mm²] data: 10A/MSTBC-MT 0,5-1,0 (3190564); 10A/MSTBC-MT 0,5-1,0 BA (3190645); 12A/MSTBC-MT 1,5-2,5 (3190551); 12A/MSTBC-MT 1,5-2,5 BA (3190658). BA = Bandkontakte

Printed-circuit board connector - MSTBC 2,5/24-STZ-5,08 - 1809721



Plug component, Nominal current: 12 A, Rated voltage (III/2): 320 V, Number of positions: 24, Pitch: 5.08 mm, Connection method: Crimp connection, Color: green, Corresponding female crimp contacts with current [A] and conductor cross section range [mm²] data: 10A/MSTBC-MT 0,5-1,0 (3190564); 10A/MSTBC-MT 0,5-1,0 BA (3190645); 12A/MSTBC-MT 1,5-2,5 (3190551); 12A/MSTBC-MT 1,5-2,5 BA (3190658). BA = Bandkontakte

Printed-circuit board connector - MSTBC 2,5/14-STZ-5,08 - 1809624



Plug component, Nominal current: 12 A, Rated voltage (III/2): 320 V, Number of positions: 14, Pitch: 5.08 mm, Connection method: Crimp connection, Color: green, Corresponding female crimp contacts with current [A] and conductor cross section range [mm²] data: 10A/MSTBC-MT 0,5-1,0 (3190564); 10A/MSTBC-MT 0,5-1,0 BA (3190645); 12A/MSTBC-MT 1,5-2,5 (3190551); 12A/MSTBC-MT 1,5-2,5 BA (3190658). BA = Bandkontakte

Printed-circuit board connector - MSTBC 2,5/20-STZ-5,08 - 1809682



Plug component, Nominal current: 12 A, Rated voltage (III/2): 320 V, Number of positions: 20, Pitch: 5.08 mm, Connection method: Crimp connection, Color: green, Corresponding female crimp contacts with current [A] and conductor cross section range [mm²] data: 10A/MSTBC-MT 0,5-1,0 (3190564); 10A/MSTBC-MT 0,5-1,0 BA (3190645); 12A/MSTBC-MT 1,5-2,5 (3190551); 12A/MSTBC-MT 1,5-2,5 BA (3190658). BA = Bandkontakte

Feed-through terminal block - UKK 3-MSTB-5,08 BU - 2770286

Accessories

Printed-circuit board connector - MSTBC 2,5/12-STZ-5,08 - 1809608



Plug component, Nominal current: 12 A, Rated voltage (III/2): 320 V, Number of positions: 12, Pitch: 5.08 mm, Connection method: Crimp connection, Color: green, Corresponding female crimp contacts with current [A] and conductor cross section range [mm²] data: 10A/MSTBC-MT 0,5-1,0 (3190564); 10A/MSTBC-MT 0,5-1,0 BA (3190645); 12A/MSTBC-MT 1,5-2,5 (3190551); 12A/MSTBC-MT 1,5-2,5 BA (3190658). BA = Bandkontakte

Printed-circuit board connector - MSTBC 2,5/17-STZ-5,08 - 1809653



Plug component, Nominal current: 12 A, Rated voltage (III/2): 320 V, Number of positions: 17, Pitch: 5.08 mm, Connection method: Crimp connection, Color: green, Corresponding female crimp contacts with current [A] and conductor cross section range [mm²] data: 10A/MSTBC-MT 0,5-1,0 (3190564); 10A/MSTBC-MT 0,5-1,0 BA (3190645); 12A/MSTBC-MT 1,5-2,5 (3190551); 12A/MSTBC-MT 1,5-2,5 BA (3190658). BA = Bandkontakte

Printed-circuit board connector - MSTBC 2,5/10-STZ-5,08 - 1809585



Plug component, Nominal current: 12 A, Rated voltage (III/2): 320 V, Number of positions: 10, Pitch: 5.08 mm, Connection method: Crimp connection, Color: green, Corresponding female crimp contacts with current [A] and conductor cross section range [mm²] data: 10A/MSTBC-MT 0,5-1,0 (3190564); 10A/MSTBC-MT 0,5-1,0 BA (3190645); 12A/MSTBC-MT 1,5-2,5 (3190551); 12A/MSTBC-MT 1,5-2,5 BA (3190658). BA = Bandkontakte

Printed-circuit board connector - MSTBC 2,5/ 4-STZ-5,08 - 1809527



Plug component, Nominal current: 12 A, Rated voltage (III/2): 320 V, Number of positions: 4, Pitch: 5.08 mm, Connection method: Crimp connection, Color: green, Corresponding female crimp contacts with current [A] and conductor cross section range [mm²] data: 10A/MSTBC-MT 0,5-1,0 (3190564); 10A/MSTBC-MT 0,5-1,0 BA (3190645); 12A/MSTBC-MT 1,5-2,5 (3190551); 12A/MSTBC-MT 1,5-2,5 BA (3190658). BA = Bandkontakte

Printed-circuit board connector - MSTBC 2,5/23-STZ-5,08 - 1809718



Plug component, Nominal current: 12 A, Rated voltage (III/2): 320 V, Number of positions: 23, Pitch: 5.08 mm, Connection method: Crimp connection, Color: green, Corresponding female crimp contacts with current [A] and conductor cross section range [mm²] data: 10A/MSTBC-MT 0,5-1,0 (3190564); 10A/MSTBC-MT 0,5-1,0 BA (3190645); 12A/MSTBC-MT 1,5-2,5 (3190551); 12A/MSTBC-MT 1,5-2,5 BA (3190658). BA = Bandkontakte

Feed-through terminal block - UKK 3-MSTB-5,08 BU - 2770286

Accessories

Printed-circuit board connector - MSTBC 2,5/ 3-STZ-5,08 - 1809514



Plug component, Nominal current: 12 A, Rated voltage (III/2): 320 V, Number of positions: 3, Pitch: 5.08 mm, Connection method: Crimp connection, Color: green, Corresponding female crimp contacts with current [A] and conductor cross section range [mm²] data: 10A/MSTBC-MT 0,5-1,0 (3190564); 10A/MSTBC-MT 0,5-1,0 BA (3190645); 12A/MSTBC-MT 1,5-2,5 (3190551); 12A/MSTBC-MT 1,5-2,5 BA (3190658). BA = Bandkontakte

Printed-circuit board connector - MSTBC 2,5/ 7-STZ-5,08 - 1809556



Plug component, Nominal current: 12 A, Rated voltage (III/2): 320 V, Number of positions: 7, Pitch: 5.08 mm, Connection method: Crimp connection, Color: green, Corresponding female crimp contacts with current [A] and conductor cross section range [mm²] data: 10A/MSTBC-MT 0,5-1,0 (3190564); 10A/MSTBC-MT 0,5-1,0 BA (3190645); 12A/MSTBC-MT 1,5-2,5 (3190551); 12A/MSTBC-MT 1,5-2,5 BA (3190658). BA = Bandkontakte

Printed-circuit board connector - MSTBC 2,5/ 8-STZ-5,08 - 1809569



Plug component, Nominal current: 12 A, Rated voltage (III/2): 320 V, Number of positions: 8, Pitch: 5.08 mm, Connection method: Crimp connection, Color: green, Corresponding female crimp contacts with current [A] and conductor cross section range [mm²] data: 10A/MSTBC-MT 0,5-1,0 (3190564); 10A/MSTBC-MT 0,5-1,0 BA (3190645); 12A/MSTBC-MT 1,5-2,5 (3190551); 12A/MSTBC-MT 1,5-2,5 BA (3190658). BA = Bandkontakte

Printed-circuit board connector - MSTBC 2,5/11-STZ-5,08 - 1809598



Plug component, Nominal current: 12 A, Rated voltage (III/2): 320 V, Number of positions: 11, Pitch: 5.08 mm, Connection method: Crimp connection, Color: green, Corresponding female crimp contacts with current [A] and conductor cross section range [mm²] data: 10A/MSTBC-MT 0,5-1,0 (3190564); 10A/MSTBC-MT 0,5-1,0 BA (3190645); 12A/MSTBC-MT 1,5-2,5 (3190551); 12A/MSTBC-MT 1,5-2,5 BA (3190658). BA = Bandkontakte

Printed-circuit board connector - MSTBC 2,5/18-STZ-5,08 - 1809666



Plug component, Nominal current: 12 A, Rated voltage (III/2): 320 V, Number of positions: 18, Pitch: 5.08 mm, Connection method: Crimp connection, Color: green, Corresponding female crimp contacts with current [A] and conductor cross section range [mm²] data: 10A/MSTBC-MT 0,5-1,0 (3190564); 10A/MSTBC-MT 0,5-1,0 BA (3190645); 12A/MSTBC-MT 1,5-2,5 (3190551); 12A/MSTBC-MT 1,5-2,5 BA (3190658). BA = Bandkontakte

Feed-through terminal block - UKK 3-MSTB-5,08 BU - 2770286

Accessories

Printed-circuit board connector - MSTB 2,5/ 3-STF-5,08 - 1777992

Plug component, Nominal current: 12 A, Rated voltage (III/2): 320 V, Number of positions: 3, Pitch: 5.08 mm, Connection method: Screw connection, Color: green, Contact surface: Tin



Printed-circuit board connector - MSTB 2,5/ 6-STF-5,08 - 1778027

Plug component, Nominal current: 12 A, Rated voltage (III/2): 320 V, Number of positions: 6, Pitch: 5.08 mm, Connection method: Screw connection, Color: green, Contact surface: Tin



Printed-circuit board connector - MSTB 2,5/ 8-STF-5,08 - 1778043

Plug component, Nominal current: 12 A, Rated voltage (III/2): 320 V, Number of positions: 8, Pitch: 5.08 mm, Connection method: Screw connection, Color: green, Contact surface: Tin



Printed-circuit board connector - MSTB 2,5/15-STF-5,08 - 1778111

Plug component, Nominal current: 12 A, Rated voltage (III/2): 320 V, Number of positions: 15, Pitch: 5.08 mm, Connection method: Screw connection, Color: green, Contact surface: Tin



Printed-circuit board connector - MSTB 2,5/16-STF-5,08 - 1778124

Plug component, Nominal current: 12 A, Rated voltage (III/2): 320 V, Number of positions: 16, Pitch: 5.08 mm, Connection method: Screw connection, Color: green, Contact surface: Tin



Feed-through terminal block - UKK 3-MSTB-5,08 BU - 2770286

Accessories

Printed-circuit board connector - MSTB 2,5/17-STF-5,08 - 1778137

Plug component, Nominal current: 12 A, Rated voltage (III/2): 320 V, Number of positions: 17, Pitch: 5.08 mm, Connection method: Screw connection, Color: green, Contact surface: Tin



Printed-circuit board connector - MSTB 2,5/12-STF-5,08 - 1778085

Plug component, Nominal current: 12 A, Rated voltage (III/2): 320 V, Number of positions: 12, Pitch: 5.08 mm, Connection method: Screw connection, Color: green, Contact surface: Tin



Printed-circuit board connector - MSTB 2,5/ 5-STF-5,08 - 1778014

Plug component, Nominal current: 12 A, Rated voltage (III/2): 320 V, Number of positions: 5, Pitch: 5.08 mm, Connection method: Screw connection, Color: green, Contact surface: Tin



Printed-circuit board connector - MSTB 2,5/ 9-STF-5,08 - 1778056

Plug component, Nominal current: 12 A, Rated voltage (III/2): 320 V, Number of positions: 9, Pitch: 5.08 mm, Connection method: Screw connection, Color: green, Contact surface: Tin



Printed-circuit board connector - MSTB 2,5/14-STF-5,08 - 1778108

Plug component, Nominal current: 12 A, Rated voltage (III/2): 320 V, Number of positions: 14, Pitch: 5.08 mm, Connection method: Screw connection, Color: green, Contact surface: Tin



Feed-through terminal block - UKK 3-MSTB-5,08 BU - 2770286

Accessories

Printed-circuit board connector - MSTB 2,5/ 2-STF-5,08 - 1777989

Plug component, Nominal current: 12 A, Rated voltage (III/2): 320 V, Number of positions: 2, Pitch: 5.08 mm, Connection method: Screw connection, Color: green, Contact surface: Tin



Printed-circuit board connector - MSTB 2,5/18-STF-5,08 - 1778140

Plug component, Nominal current: 12 A, Rated voltage (III/2): 320 V, Number of positions: 18, Pitch: 5.08 mm, Connection method: Screw connection, Color: green, Contact surface: Tin



Printed-circuit board connector - MSTB 2,5/11-STF-5,08 - 1778072

Plug component, Nominal current: 12 A, Rated voltage (III/2): 320 V, Number of positions: 11, Pitch: 5.08 mm, Connection method: Screw connection, Color: green, Contact surface: Tin



Printed-circuit board connector - MSTB 2,5/ 4-STF-5,08 - 1778001

Plug component, Nominal current: 12 A, Rated voltage (III/2): 320 V, Number of positions: 4, Pitch: 5.08 mm, Connection method: Screw connection, Color: green, Contact surface: Tin



Printed-circuit board connector - MSTB 2,5/ 7-STF-5,08 - 1778030

Plug component, Nominal current: 12 A, Rated voltage (III/2): 320 V, Number of positions: 7, Pitch: 5.08 mm, Connection method: Screw connection, Color: green, Contact surface: Tin



Feed-through terminal block - UKK 3-MSTB-5,08 BU - 2770286

Accessories

Printed-circuit board connector - MSTB 2,5/10-STF-5,08 - 1778069

Plug component, Nominal current: 12 A, Rated voltage (III/2): 320 V, Number of positions: 10, Pitch: 5.08 mm, Connection method: Screw connection, Color: green, Contact surface: Tin



Printed-circuit board connector - MSTB 2,5/13-STF-5,08 - 1778098

Plug component, Nominal current: 12 A, Rated voltage (III/2): 320 V, Number of positions: 13, Pitch: 5.08 mm, Connection method: Screw connection, Color: green, Contact surface: Tin



Printed-circuit board connector - MSTB 2,5/19-STF-5,08 - 1778153

Plug component, Nominal current: 12 A, Rated voltage (III/2): 320 V, Number of positions: 19, Pitch: 5.08 mm, Connection method: Screw connection, Color: green, Contact surface: Tin



Plug - MSTB 2,5/20-STF-5,08 - 1778166

Plug component, Nominal current: 12 A, Rated voltage (III/2): 320 V, Number of positions: 20, Pitch: 5.08 mm, Connection method: Screw connection, Color: green, Contact surface: Tin



Printed-circuit board connector - MSTBT 2,5/ 2-STF-5,08 - 1805301

Plug component, Nominal current: 12 A, Rated voltage (III/2): 320 V, Number of positions: 2, Pitch: 5.08 mm, Connection method: Screw connection, Color: green, Contact surface: Tin



Feed-through terminal block - UKK 3-MSTB-5,08 BU - 2770286

Accessories

Printed-circuit board connector - MSTBT 2,5/12-STF-5,08 - 1805398

Plug component, Nominal current: 12 A, Rated voltage (III/2): 320 V, Number of positions: 12, Pitch: 5.08 mm, Connection method: Screw connection, Color: green, Contact surface: Tin



Printed-circuit board connector - MSTBT 2,5/10-STF-5,08 - 1805372

Plug component, Nominal current: 12 A, Rated voltage (III/2): 320 V, Number of positions: 10, Pitch: 5.08 mm, Connection method: Screw connection, Color: green, Contact surface: Tin



Printed-circuit board connector - MSTBT 2,5/11-STF-5,08 - 1805385

Plug component, Nominal current: 12 A, Rated voltage (III/2): 320 V, Number of positions: 11, Pitch: 5.08 mm, Connection method: Screw connection, Color: green, Contact surface: Tin



Printed-circuit board connector - FKC 2,5/ 8-STF-5,08 - 1873265

Plug component, Nominal current: 12 A, Rated voltage (III/2): 320 V, Number of positions: 8, Pitch: 5.08 mm, Connection method: Spring-cage conn., Color: green, Contact surface: Tin



Printed-circuit board connector - FKC 2,5/ 5-STF-5,08 - 1873236

Plug component, Nominal current: 12 A, Rated voltage (III/2): 320 V, Number of positions: 5, Pitch: 5.08 mm, Connection method: Spring-cage conn., Color: green, Contact surface: Tin



Feed-through terminal block - UKK 3-MSTB-5,08 BU - 2770286

Accessories

Printed-circuit board connector - FKC 2,5/ 2-STF-5,08 - 1873207

Plug component, Nominal current: 12 A, Rated voltage (III/2): 320 V, Number of positions: 2, Pitch: 5.08 mm, Connection method: Spring-cage conn., Color: green, Contact surface: Tin



Printed-circuit board connector - FKC 2,5/14-STF-5,08 - 1873320

Plug component, Nominal current: 12 A, Rated voltage (III/2): 320 V, Number of positions: 14, Pitch: 5.08 mm, Connection method: Spring-cage conn., Color: green, Contact surface: Tin



Printed-circuit board connector - FKC 2,5/ 9-STF-5,08 - 1873278

Plug component, Nominal current: 12 A, Rated voltage (III/2): 320 V, Number of positions: 9, Pitch: 5.08 mm, Connection method: Spring-cage conn., Color: green, Contact surface: Tin



Printed-circuit board connector - QC 1/ 2-STF-5,08 - 1883352

Plug component, Nominal current: 10 A, Rated voltage (III/2): 630 V, Number of positions: 2, Pitch: 5.08 mm, Connection method: Insulation displacement connection QUICKON, Color: green, Contact surface: Tin



Printed-circuit board connector - QC 1/ 3-STF-5,08 - 1883365

Plug component, Nominal current: 10 A, Rated voltage (III/2): 630 V, Number of positions: 3, Pitch: 5.08 mm, Connection method: Insulation displacement connection QUICKON, Color: green, Contact surface: Tin

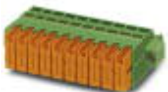

Feed-through terminal block - UKK 3-MSTB-5,08 BU - 2770286

Accessories

Printed-circuit board connector - QC 1/ 7-STF-5,08 - 1883404

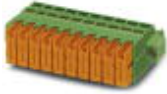

Plug component, Nominal current: 10 A, Rated voltage (III/2): 630 V, Number of positions: 7, Pitch: 5.08 mm, Connection method: Insulation displacement connection QUICKON, Color: green, Contact surface: Tin

Printed-circuit board connector - QC 1/15-STF-5,08 - 1883886



Plug component, Nominal current: 10 A, Rated voltage (III/2): 630 V, Number of positions: 15, Pitch: 5.08 mm, Connection method: Insulation displacement connection QUICKON, Color: green, Contact surface: Tin

Printed-circuit board connector - QC 1/12-STF-5,08 - 1883459



Plug component, Nominal current: 10 A, Rated voltage (III/2): 630 V, Number of positions: 12, Pitch: 5.08 mm, Connection method: Insulation displacement connection QUICKON, Color: green, Contact surface: Tin

Printed-circuit board connector - MSTBC 2,5/ 8-STZF-5,08 - 1809792



Plug component, Nominal current: 12 A, Rated voltage (III/2): 320 V, Number of positions: 8, Pitch: 5.08 mm, Connection method: Crimp connection, Color: green, Corresponding female crimp contacts with current [A] and conductor cross section range [mm²] data: 10A/MSTBC-MT 0,5-1,0 (3190564); 10A/MSTBC-MT 0,5-1,0 BA (3190645); 12A/MSTBC-MT 1,5-2,5 (3190551); 12A/MSTBC-MT 1,5-2,5 BA (3190658). BA = Bandkontakte

Printed-circuit board connector - MSTBC 2,5/19-STZF-5,08 - 1809909



Plug component, Nominal current: 12 A, Rated voltage (III/2): 320 V, Number of positions: 19, Pitch: 5.08 mm, Connection method: Crimp connection, Color: green, Corresponding female crimp contacts with current [A] and conductor cross section range [mm²] data: 10A/MSTBC-MT 0,5-1,0 (3190564); 10A/MSTBC-MT 0,5-1,0 BA (3190645); 12A/MSTBC-MT 1,5-2,5 (3190551); 12A/MSTBC-MT 1,5-2,5 BA (3190658). BA = Bandkontakte

Feed-through terminal block - UKK 3-MSTB-5,08 BU - 2770286

Accessories

Printed-circuit board connector - MSTBC 2,5/ 9-STZF-5,08 - 1809802



Plug component, Nominal current: 12 A, Rated voltage (III/2): 320 V, Number of positions: 9, Pitch: 5.08 mm, Connection method: Crimp connection, Color: green, Corresponding female crimp contacts with current [A] and conductor cross section range [mm²] data: 10A/MSTBC-MT 0,5-1,0 (3190564); 10A/MSTBC-MT 0,5-1,0 BA (3190645); 12A/MSTBC-MT 1,5-2,5 (3190551); 12A/MSTBC-MT 1,5-2,5 BA (3190658). BA = Bandkontakte

Printed-circuit board connector - MSTBC 2,5/ 6-STZF-5,08 - 1809776



Plug component, Nominal current: 12 A, Rated voltage (III/2): 320 V, Number of positions: 6, Pitch: 5.08 mm, Connection method: Crimp connection, Color: green, Corresponding female crimp contacts with current [A] and conductor cross section range [mm²] data: 10A/MSTBC-MT 0,5-1,0 (3190564); 10A/MSTBC-MT 0,5-1,0 BA (3190645); 12A/MSTBC-MT 1,5-2,5 (3190551); 12A/MSTBC-MT 1,5-2,5 BA (3190658). BA = Bandkontakte

Printed-circuit board connector - MSTBC 2,5/18-STZF-5,08 - 1809899



Plug component, Nominal current: 12 A, Rated voltage (III/2): 320 V, Number of positions: 18, Pitch: 5.08 mm, Connection method: Crimp connection, Color: green, Corresponding female crimp contacts with current [A] and conductor cross section range [mm²] data: 10A/MSTBC-MT 0,5-1,0 (3190564); 10A/MSTBC-MT 0,5-1,0 BA (3190645); 12A/MSTBC-MT 1,5-2,5 (3190551); 12A/MSTBC-MT 1,5-2,5 BA (3190658). BA = Bandkontakte

Drawings

Feed-through terminal block - UKK 3-MSTB-5,08 BU - 2770286

Dimensioned drawing

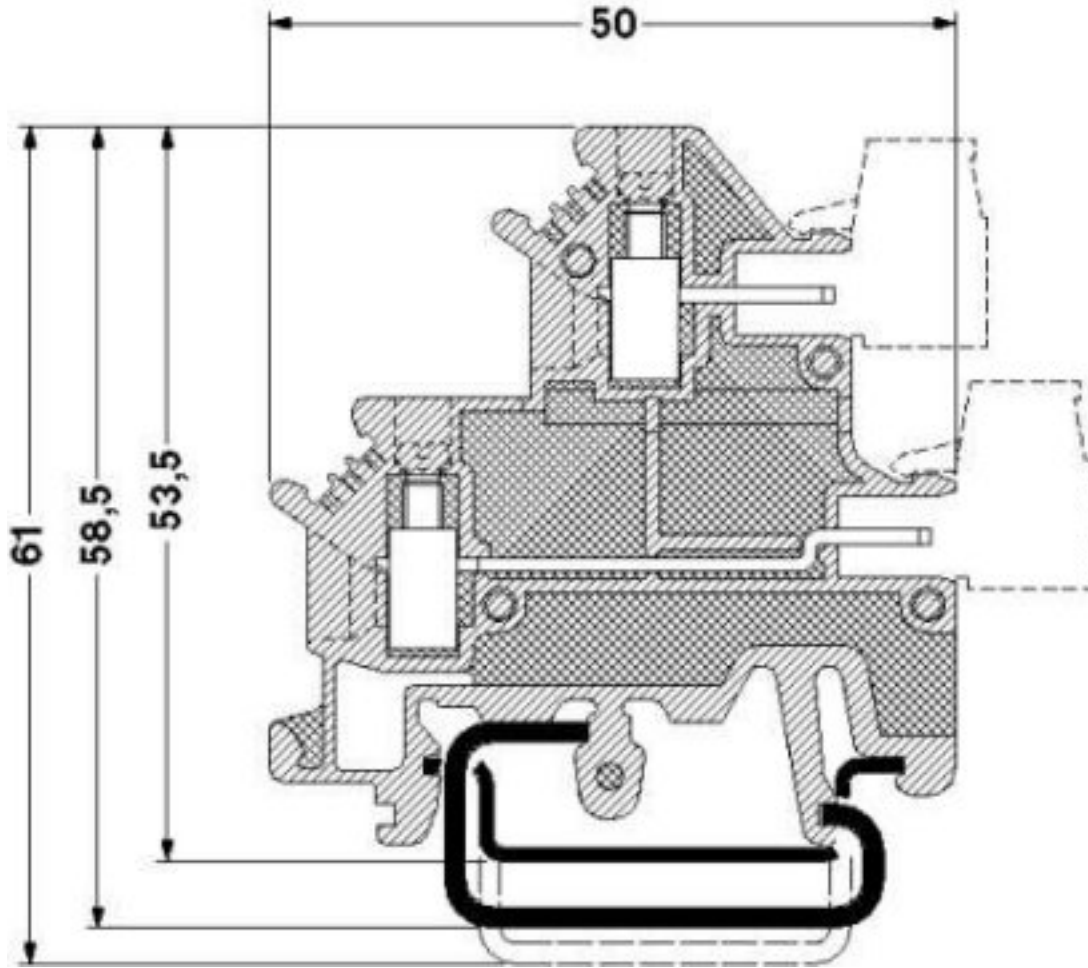

Компания «Life Electronics» занимается поставками электронных компонентов импортного и отечественного производства от производителей и со складов крупных дистрибьюторов Европы, Америки и Азии.

С конца 2013 года компания активно расширяет линейку поставок компонентов по направлению коаксиальный кабель, кварцевые генераторы и конденсаторы (керамические, пленочные, электролитические), за счёт заключения дистрибьюторских договоров

Мы предлагаем:

- Конкуренеспособные цены и скидки постоянным клиентам.
- Специальные условия для постоянных клиентов.
- Подбор аналогов.
- Поставку компонентов в любых объемах, удовлетворяющих вашим потребностям.
- Приемлемые сроки поставки, возможна ускоренная поставка.
- Доставку товара в любую точку России и стран СНГ.
- Комплексную поставку.
- Работу по проектам и поставку образцов.
- Формирование склада под заказчика.
- Сертификаты соответствия на поставляемую продукцию (по желанию клиента).
- Тестирование поставляемой продукции.
- Поставку компонентов, требующих военную и космическую приемку.
- Входной контроль качества.
- Наличие сертификата ISO.

В составе нашей компании организован Конструкторский отдел, призванный помогать разработчикам, и инженерам.

Конструкторский отдел помогает осуществить:

- Регистрацию проекта у производителя компонентов.
- Техническую поддержку проекта.
- Защиту от снятия компонента с производства.
- Оценку стоимости проекта по компонентам.
- Изготовление тестовой платы монтаж и пусконаладочные работы.



Тел: +7 (812) 336 43 04 (многоканальный)

Email: org@lifeelectronics.ru