

C5P

User Manual

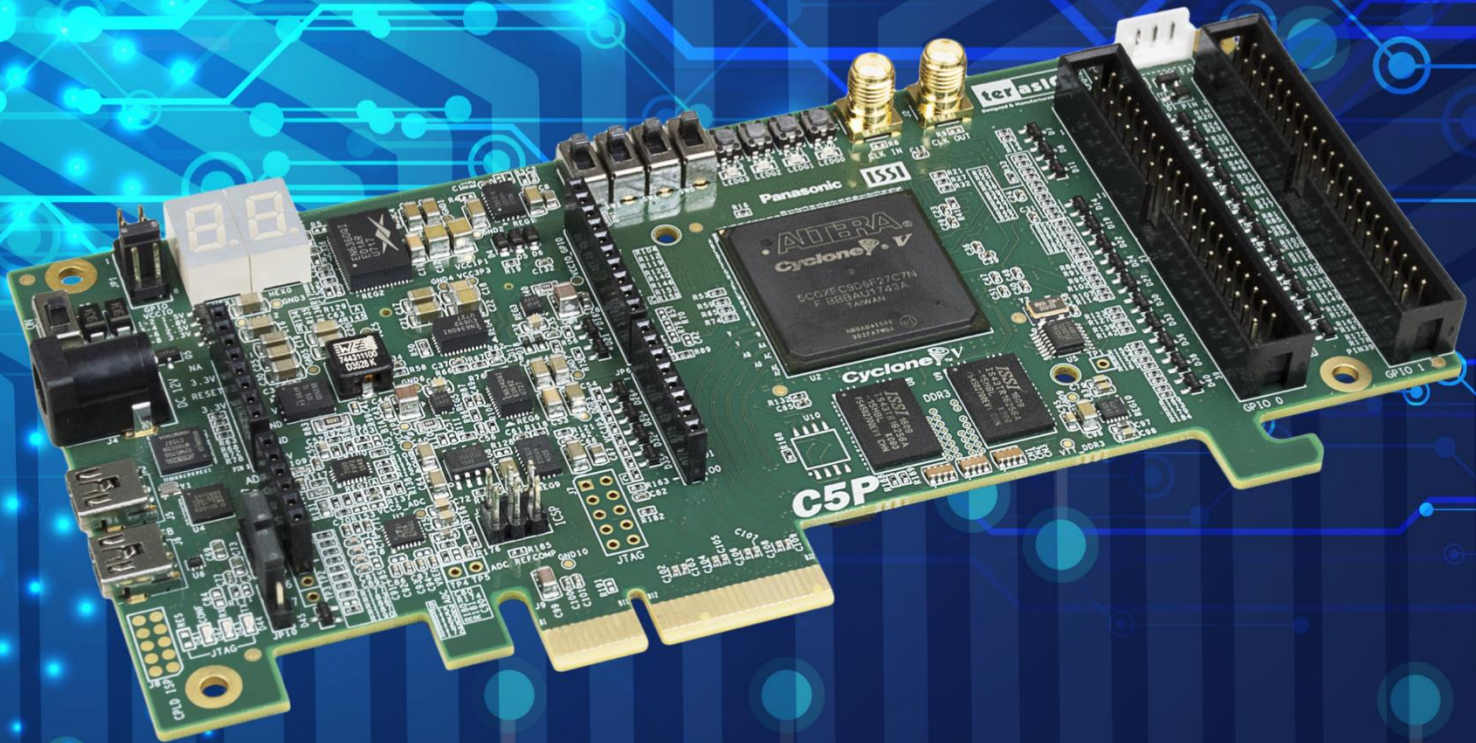

Contents

Chapter 1 C5P Development Kit	4
1.1 Package Contents	4
1.2 C5P System CD	5
1.3 Getting Help	5
Chapter 2 Introduction of the C5P board	6
2.1 Layout and Components.....	6
2.2 Block Diagram of the C5P Board	7
Chapter 3 Using the C5P Board	10
3.1 Configuring the Cyclone V FPGA	10
3.2 Board Status Elements	14
3.3 Clock Circuitry	15
3.4 Peripherals Connected to the FPGA.....	16
Chapter 4 C5P System Builder	35
4.1 Introduction.....	35
4.2 General Design Flow	35
4.3 Using C5P System Builder.....	36
Chapter 5 Examples of Advanced Demonstrations	41
5.1 C5P Factory Default Configuration	41
5.2 Nios II SDRAM Test	42
5.3 Verilog SDRAM Test	44
5.4 DDR3 SDRAM Test	46
5.5 DDR3 SDRAM Test by Nios II.....	48
5.6 UART Control	51
5.7 ADC Reading.....	56
Chapter 6 Programming the EPCQ	61
6.1 Convert .sof File to .jic File	61
6.2 Write.jic File to EPCQ	65

6.3 Erase the EPCQ device.....	66
Chapter 7 PCIe Reference Design for Windows.....	68
7.1 PCIe System Infrastructure.....	68
7.2 PC PCIe Software SDK	69
7.3 PCIe Software Stack	69
7.4 PCIe Library API	74
7.5 PCIe Reference Design - Fundamental	79
7.6 PCIe Reference Design – DDR3	85
Chapter 8 PCIe Reference Design for Linux.....	91
8.1 PCIe System Infrastructure.....	91
8.2 PC PCIe Software SDK	92
8.3 PCIe Software Stack	92
8.4 PCIe Library API	95
8.5 PCIe Reference Design - Fundamental	95
8.6 PCIe Reference Design - DDR3	101
Chapter 9 Appendix	107
9.1 Revision History.....	107
9.2 Copyright Statement.....	107

C5P Development Kit

The C5P Development Kit presents a robust hardware design platform built around the Intel Cyclone V FPGA, it also provides a powerful platform of reconfigurable power with high performance and low power processing system. The C5P Development Kit is equipped with PCIe Gen1x4, high-speed DDR3 memory, GPIO, Arduino and much more that promises many exciting applications.

The C5P Development Board is equipped with PCIe Gen1X4 interface, it is low development cost, and can support users who develop mainstream applications and OpenCL applications based on PCIe, as well as a wide range of high-speed connectivity applications.

The C5P Development Board contains all the tools needed to use the board in conjunction with a computer that runs the Microsoft Windows 7 or later.

1.1 Package Contents

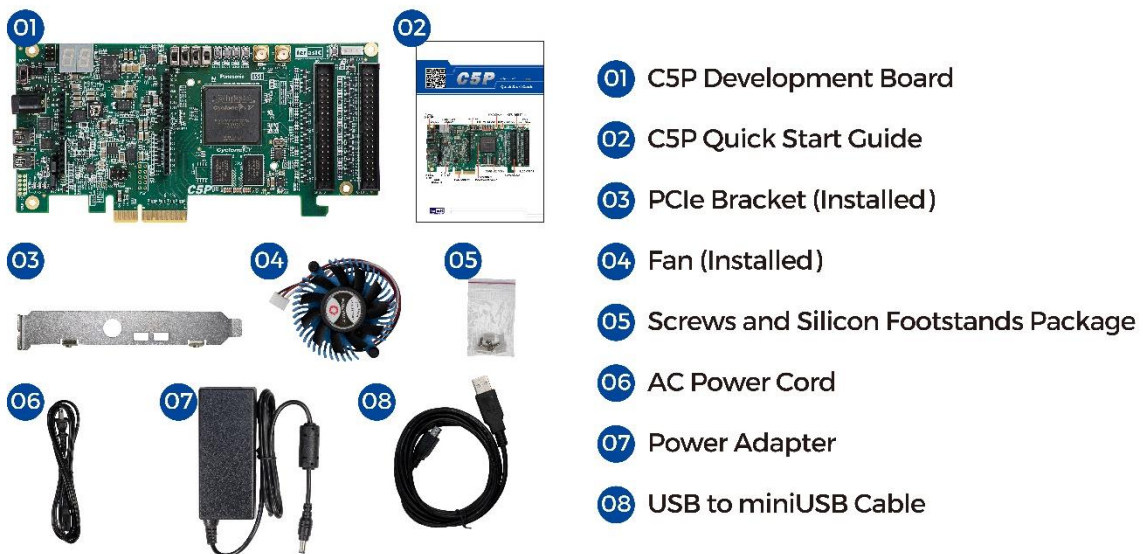

Figure 1-1 C5P package contents

■ C5P package includes

1. C5P Development Board
2. C5P Quick Start Guide
3. PCIe Bracket (Installed)
4. Fan (Installed)
5. Screw and Silicon Footstands Package
6. AC Power Cord
7. Power Adapter
8. USB to mini-USB Cable

1.2 C5P System CD

The C5P System CD contains all the documents and supporting materials associated with C5P, including the user manual, system builder, reference designs, and device datasheets. Users can download this system CD from the link c5p.terasic.com.

1.3 Getting Help

Here are the addresses where you can get help if you encounter any problems:

- Terasic Inc.
- 9F., No.176, Sec.2, Gongdao 5th Rd, East Dist, Hsinchu City, 30070. Taiwan
- Email: support@terasic.com.cn
- Tel.: +886-3-575-0880
- Website: c5p.terasic.com

Introduction of the C5P board

This chapter provides an introduction to the features and design characteristics of the C5P board.

2.1 Layout and Components

Figure 2-1 and Figure 2-2 shows a photograph of the board. It depicts the layout of the board and indicates the location of the connectors and key components.

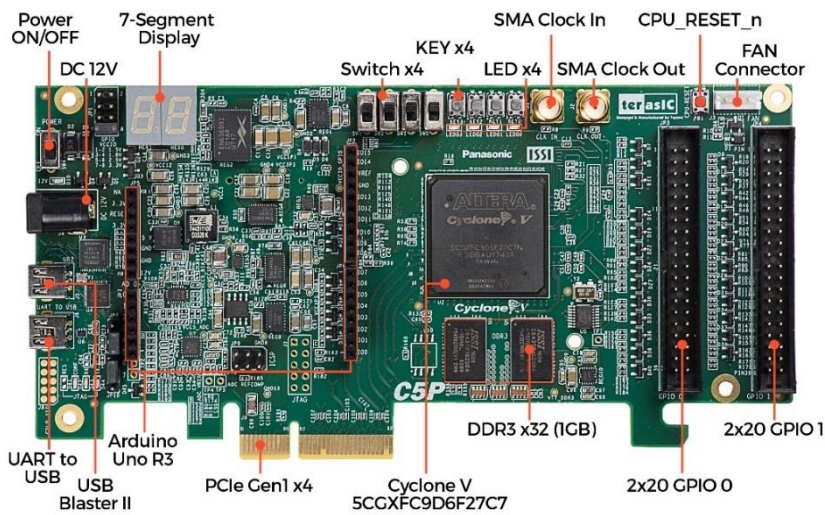

Figure 2-1 C5P development board (top view)

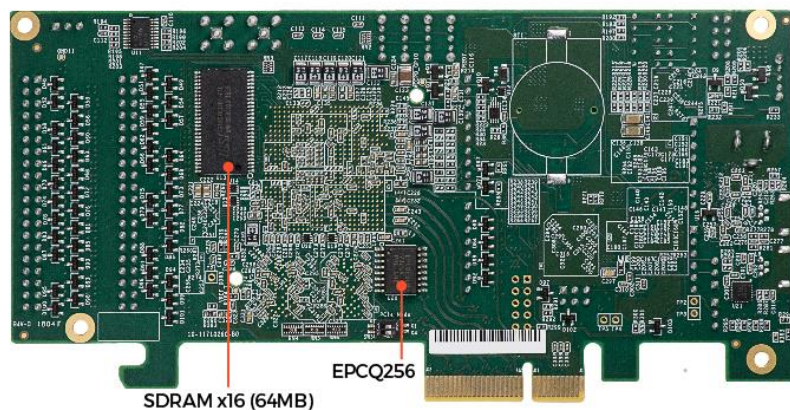

Figure 2-2 C5P development board (bottom view)

The C5P board has many features that allow users to implement a wide range of designed circuits, from simple circuits to various multimedia projects:

- Intel FPGA Cyclone® V GX 5CGXFC9D6F27C7N device
- Serial configuration device– EPCQ256
- USB-Blaster II onboard for programming; JTAG Mode
- UART to USB (USB Mini-B connector)
- PCIe Gen1x4
- 1GB DDR3 SDRAM (32-bit data bus)
- 64MB SDRAM (16-bit data bus)
- 4 push-buttons
- 4 slide switches
- 4 green LED
- Two 7-segment displays
- Four 50MHz clock sources from the clock generator
- One Arduino header
- Two 40 pin GPIO header

2.2 Block Diagram of the C5P Board

Figure 2-3 is the block diagram of the board. All the connections are established through the Cyclone V FPGA device to provide maximum flexibility for users. Users can configure the FPGA to implement any system design.

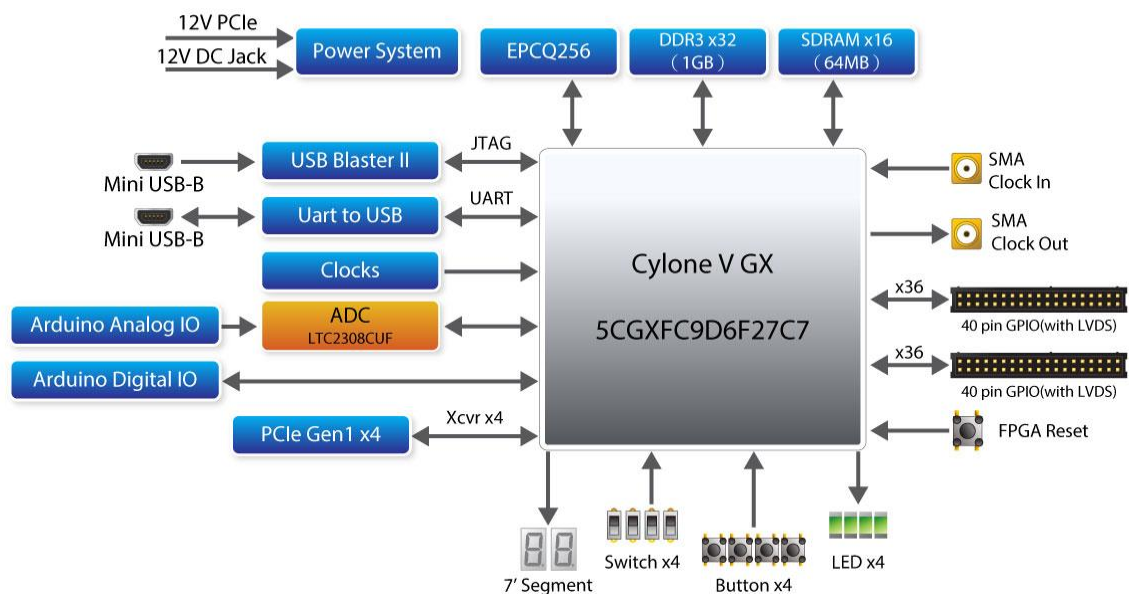

Figure 2-3 Block diagram of C5P board

Detailed information about **Figure 2-3** are listed below.

■ FPGA Device

- Cyclone V 5CGXFC9D6F27C7N device
 - 301K programmable logic elements
 - 13,917 Kbit/s embedded memory
 - 8 fractional PLLs
 - 2 hard memory controllers
 - Nine 3.125G Transceivers

■ Configuration and Debug

- Quad Serial Configuration device – EPCQ256
- Onboard USB-Blaster II (Mini-B USB connector)

■ Memory Device

- 64MB (32Mx16) SDRAM
- 1GB (2x256Mx16) DDR3 SDRAM

■ Communication

- UART to USB (USB Mini-B connector)
- PCIe Gen1x4

■ Connectors

- Two 40 Pin GPIO header, features of each GPIO connector
 - 36 General GPIO Pins
 - Support to configure as 8 LVDS TX and LVDS RX
 - With diode protection
 - Configurable I/O standards (voltage levels: 3.3/2.5/1.8/1.5V)
- One Arduino Uno Revision 3 header
 - Analog ADC
 - Interface: SPI
 - Fast through put rate: 500Ksps
 - Channel number: 8
 - Resolution: 12-bit
 - Analog input range: 0 ~ 4.096 V
 - Digital IO
 - With diode protection

- SMA IN/OUT 3.3V Single-end input and output

■ Switches/ Buttons/ Indicators

- 5 user Keys (4 general keys, 1 CPU_RESET_n)
- 4 user switches
- 4 LED
- Two 7-segment displays

■ Power

- 12V DC Input
- PCIe 12V Input

■ Cooling System

- 12V Fan with 5000 Rotational Speed

Using the C5P Board

This chapter provides how to instructions to use the board and describes the peripherals.

3.1 Configuring the Cyclone V FPGA

There are two types of programming method supported by C5P:

1. JTAG programming: It is named after the IEEE standards Joint Test Action Group. The configuration bitstream is downloaded directly into the Cyclone V FPGA. The FPGA will retain its current status as long as power is applied to the board; the configuration information will be lost when the power is off.
2. AS programming: The other programming method is Active Serial configuration. The configuration bitstream is downloaded into the Intel FPGA EPCQ256 device, which provides non-volatile storage for the bit stream. The information is retained within EPCQ256 even if the C5P board is turned off. When the board is powered on, the configuration data in the EPCQ256 device is automatically loaded into the Cyclone V FPGA.

■ JTAG Chain on C5P Board

The FPGA device can be configured through JTAG interface on the C5P board, but the JTAG chain must form a closed loop, which allows a Quartus II programmer to the detect FPGA device.

Figure 3-1 illustrates the JTAG chain on C5P board.

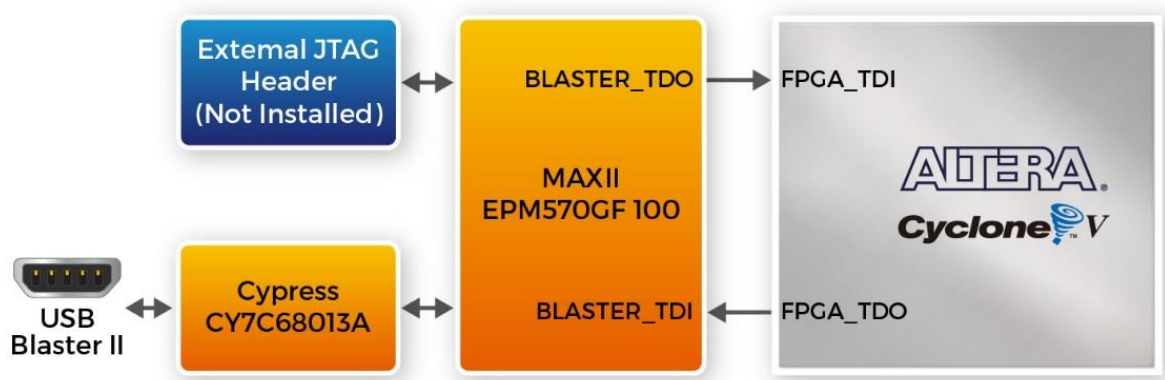

Figure 3-1 Path of the JTAG chain

■ Configure the FPGA in JTAG Mode

There is one FPGA device on the JTAG chain. The following shows how the FPGA is programmed in JTAG mode step by step.

1. Open the Quartus II programmer under Quartus Prime Tools and click “Auto Detect”, as circled in **Figure 3-2**.

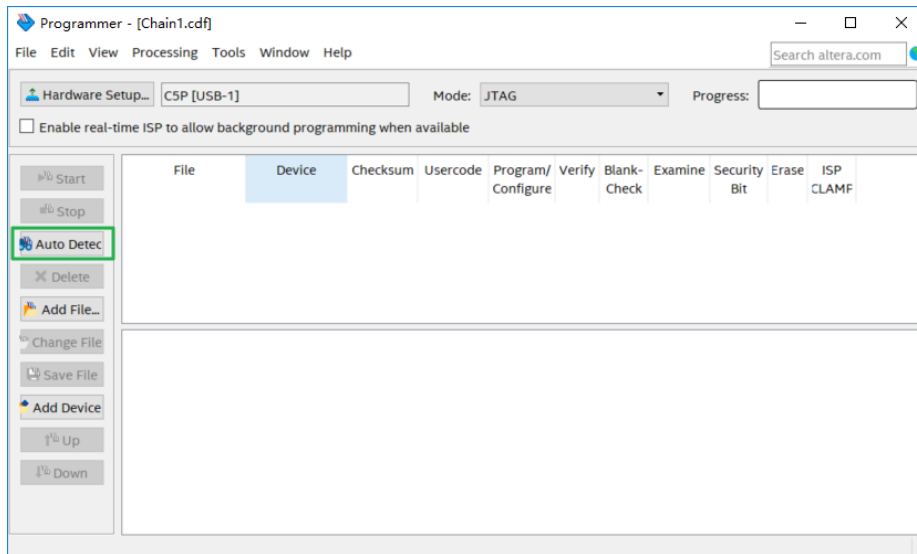

Figure 3-2 Detect FPGA device in JTAG mode

2. Select detected device associated with the board, as circled in **Figure 3-3**.

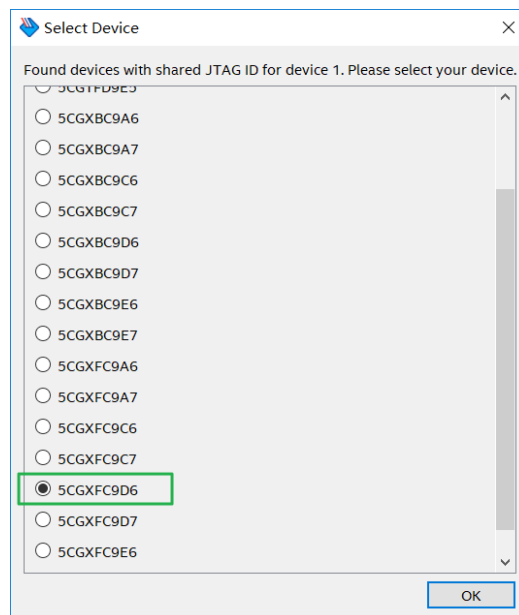

Figure 3-3 Select 5CGXFC9D6

- The FPGA is detected, as shown in **Figure 3-4**.

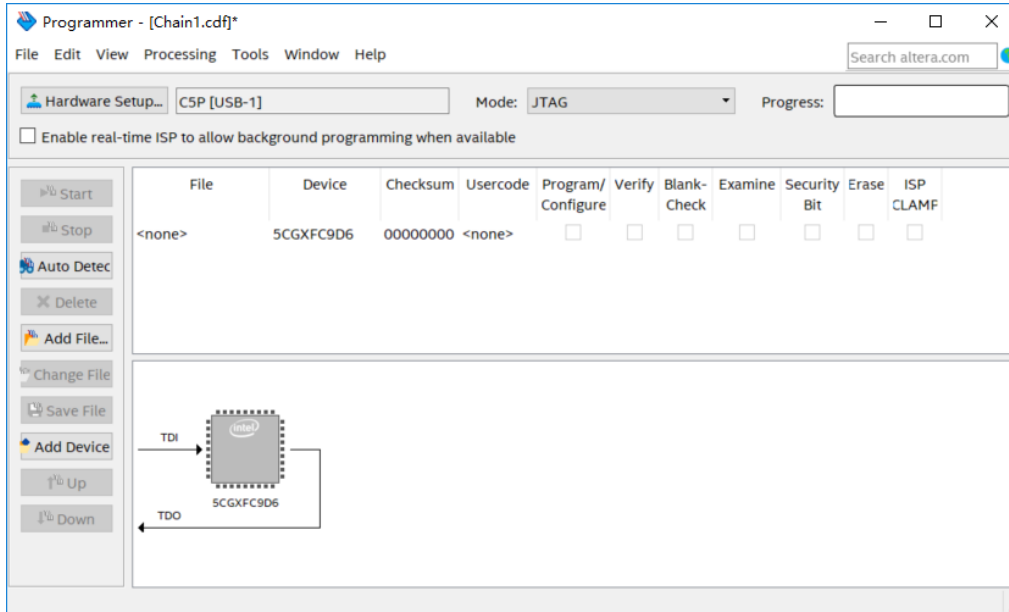

Figure 3-4 FPGA detected in Quartus programmer

- Right click on the FPGA device and select Change File to open the .sof file to be programmed, as highlighted in **Figure 3-5**.

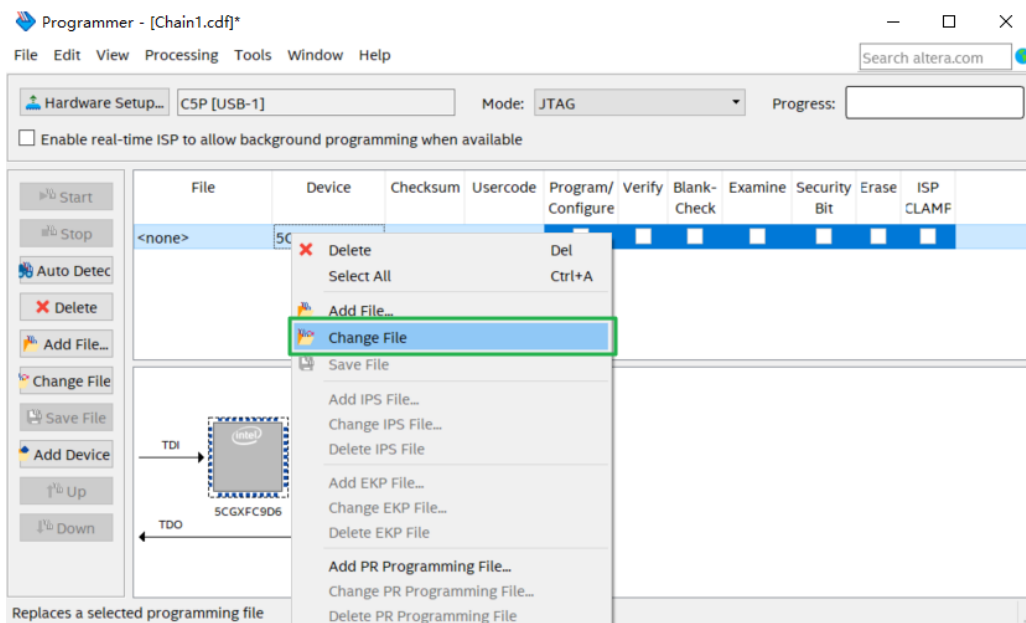

Figure 3-5 Open the .sof file to be programmed into the FPGA device

- Select the .sof file to be programmed, as shown in **Figure 3-6**.

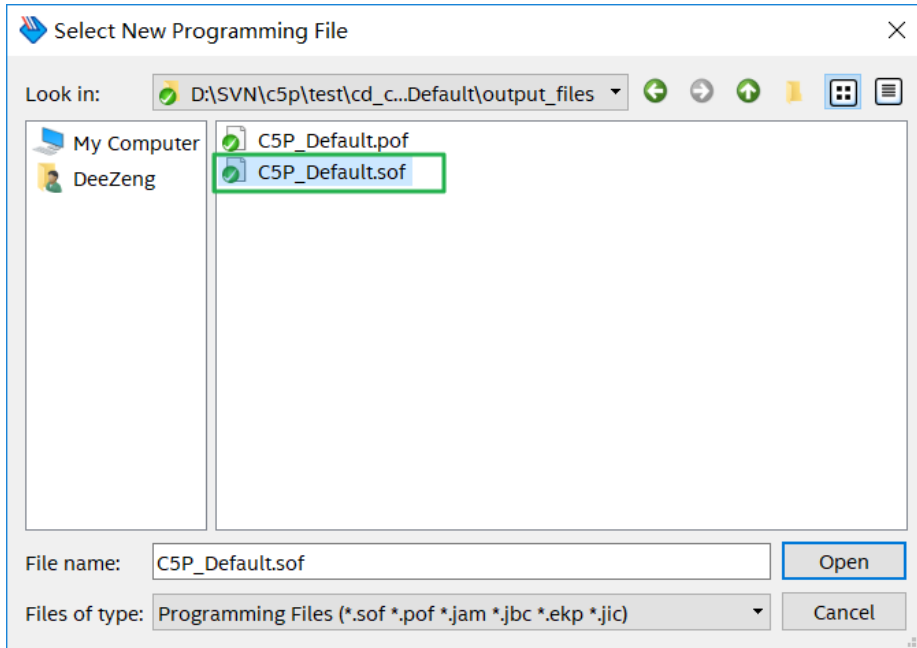

Figure 3-6 Select the .sof file to be programmed into the FPGA device

- Click “Program/Configure” check box and then click “Start” button to download the .sof file into the FPGA device, as shown in **Figure 3-7**.

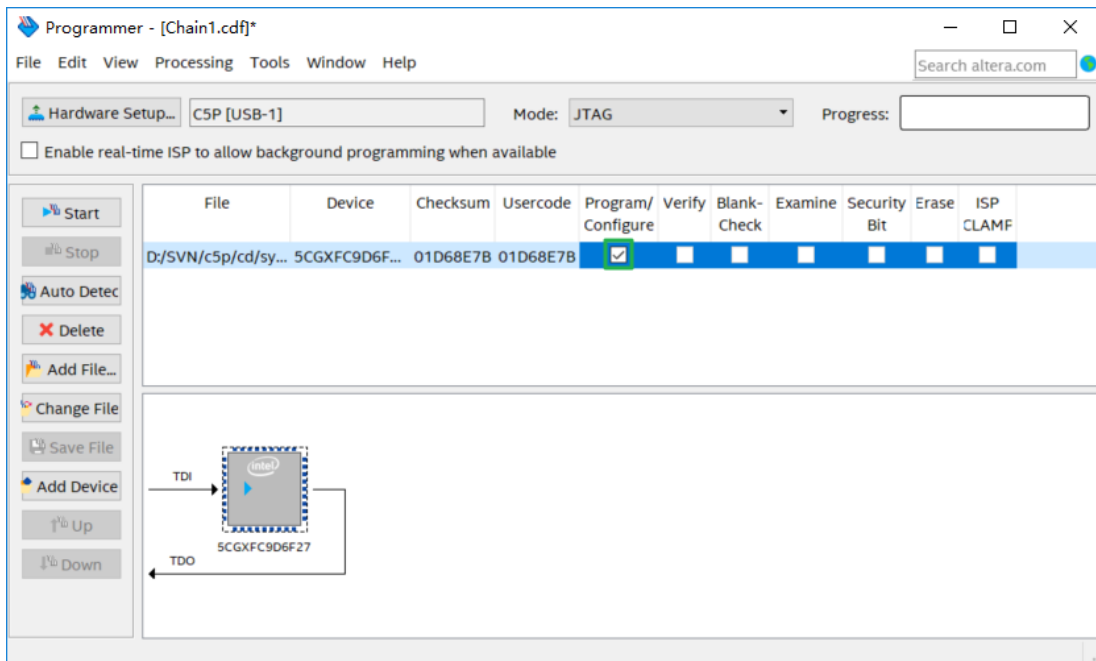

Figure 3-7 Program .sof file into the FPGA device

■ Configure the FPGA in AS Mode

- The C5P board uses the EPCSQ256 device to store configuration data for the Cyclone V FPGA. This configuration data is automatically loaded from the quad serial configuration device chip into the FPGA when the board is powered up

- Users need to use Serial Flash Loader (SFL) to program the EPCQ256 device via JTAG interface.
- The FPGA-based SFL is a soft intellectual property (IP) core within the FPGA that bridges the JTAG and Flash interfaces. The SFL Megafunction is available in Quartus Prime. **Figure 3-8** shows the programming method when adopting SFL solution.
- Please refer to [Chapter 6 Program the EPCQ](#) for the basic programming instructions on the serial configuration device.

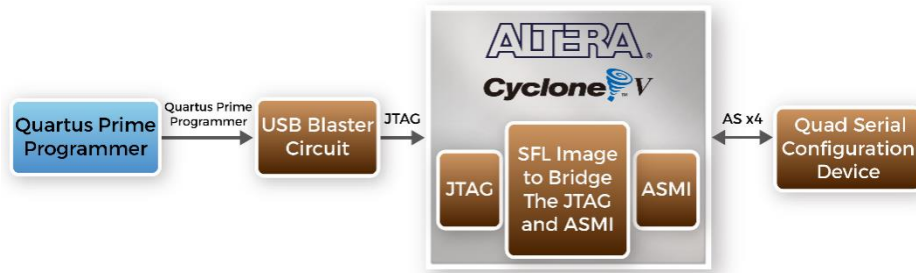

Figure 3-8 Programming a quad serial configuration device with SFL solution

3.2 Board Status Elements

In addition to the 4 LEDs that the FPGA device can control, there are 4 indicators which can indicate the board status, as shown in **Figure 3-9**, please refer the details in **Table 3-1**.

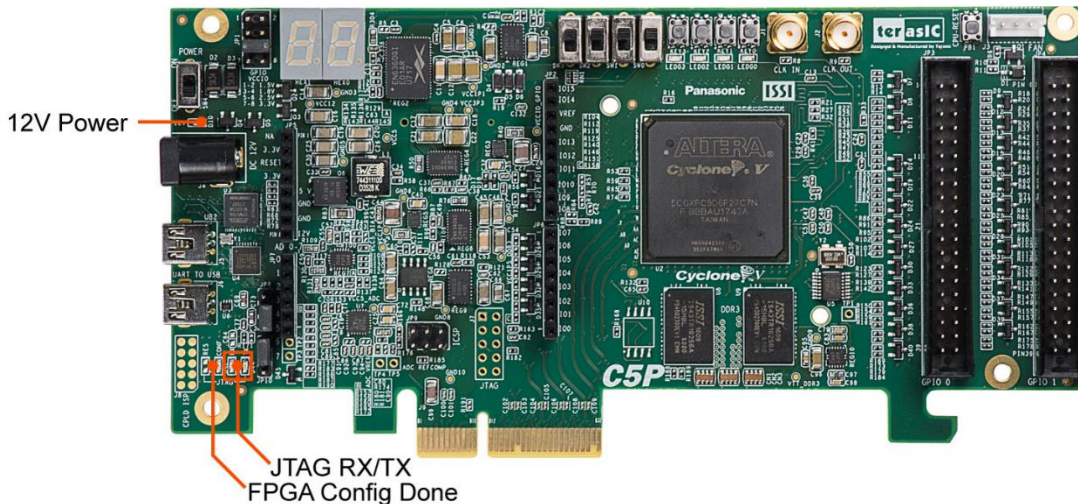

Figure 3-9 LED Indicators on C5P

Table 3-1 LED Indicators

LED Name	Signal Name	Description
D3	12V Power	Illuminates when 12V power is active
D43	JTAG_RX	Illuminates when USB Blaster II receives data
D44	JTAG_TX	Illuminates when USB Blaster II transmits data
D42	CONF_DONE	Illuminates when FPGA is configured successfully

3.3 Clock Circuitry

Figure 3-10 shows the default frequency of all external clocks to the Cyclone V FPGA. The 50MHz is generated by a crystal oscillator. The 50MHz clock signals connected to the FPGA are used as clock sources for user logic. The board also includes two SMA connectors which can be used to connect an external clock source to the board or to drive a clock signal in/out through the SMA connector. All these clock inputs are connected to the phase locked loops (PLL) clock input pins of the FPGA to allow users to use these clocks as a source clock for the PLL circuit.

The associated pin assignment for clock inputs to FPGA I/O pins is listed in **Table 3-2**.

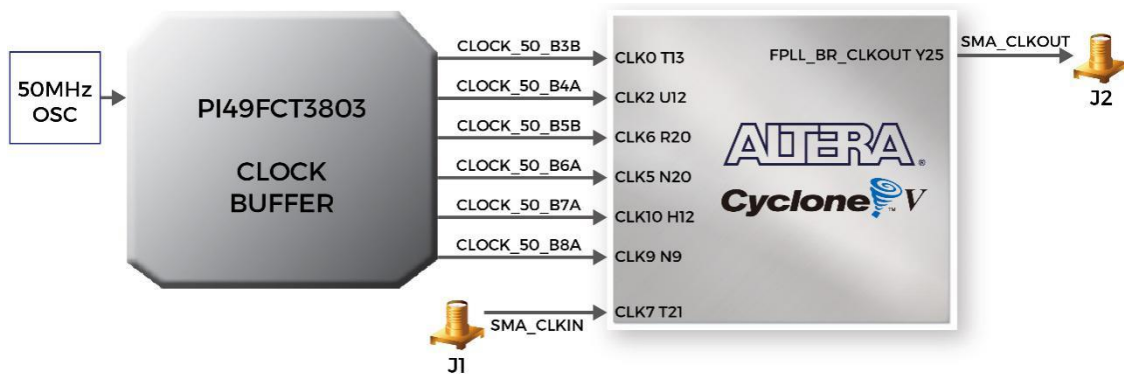

Figure 3-10 Block diagram of the clock distribution on C5P

Table 3-2 Pin Assignment of Clock Inputs

Signal Name	FPGA Pin No.	Direction	Description	I/O Standard
CLOCK_50_B3B	PIN_T13	Input	50MHz clock input (Bank 3B)	1.5 V
CLOCK_50_B4A	PIN_U12	Input	50MHz clock input (Bank 4A)	1.5 V
CLOCK_50_B5B	PIN_R20	Input	50MHz clock input (Bank 5B)	3.3-V LVTTTL
CLOCK_50_B6A	PIN_N20	Input	50MHz clock input (Bank 6A)	3.3-V LVTTTL
CLOCK_50_B7A	PIN_H12	Input	50MHz clock input (Bank 7A)	3.3-V LVTTTL

CLOCK_50_B8A	PIN_N9	Input	50MHz clock input (Bank 8A)	3.3-V LVTTL
SMA_CLKIN	PIN_T21	Input	External (SMA) clock input	3.3-V LVTTL
SMA_CLKOUT	PIN_Y25	Output	External (SMA) clock output	3.3-V LVTTL

3.4 Peripherals Connected to the FPGA

This section describes the interfaces connected to the FPGA. Users can control or monitor different interfaces with user logic from the FPGA.

3.4.1 User Push-buttons, Switches and LEDs

The board has four push-buttons connected to the FPGA, as shown in **Figure 3-11**. Schmitt trigger circuit is implemented and acts as a switch debounce in **Figure 3-12** for the push-buttons connector. The four push-buttons are named KEY0, KEY1, KEY2, and KEY3; they are coming out of the Schmitt trigger device and are connected directly to the Cyclone V FPGA. The push-button generates a high logic level when it is not pressed and provides a low logic level when pressed. Since the push-buttons are debounced, they can be used as reset inputs in a circuit.

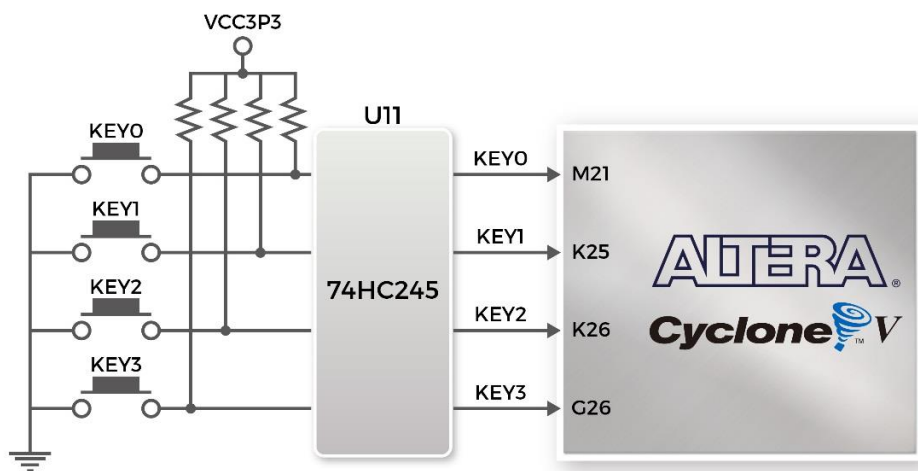

Figure 3-11 Connections between the push-buttons and the Cyclone V FPGA

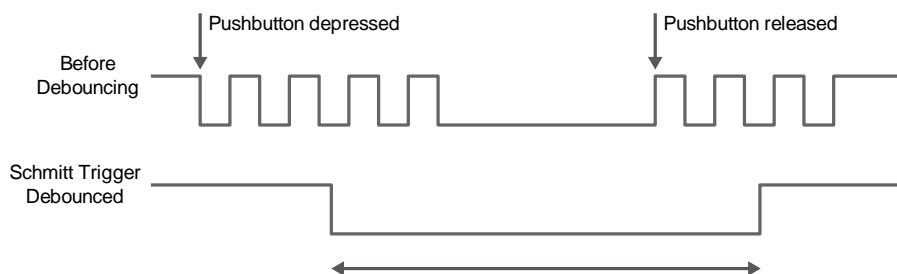

Figure 3-12 Switch debouncing

There are four slide switches connected to the FPGA, as shown in **Figure 3-13**. These switches are not debounced and are to be used as level-sensitive data inputs to a circuit. Each switch is connected directly and individually to the FPGA. When the switch is set to the DOWN position (towards the edge of the board), it generates a low logic level to the FPGA. When the switch is set to the UP position, a high logic level is generated to the FPGA.



Figure 3-13 Connections between the slide switches and Cyclone V FPGA

There are also four user-controllable LEDs connected to the FPGA. Each LED is driven directly and individually by the Cyclone V FPGA; driving its associated pin to a high logic level or low level to turn the LED on or off, respectively. **Figure 3-14** shows the connections between LEDs and Cyclone V FPGA. **Table 3-3**, **Table 3-4** and **Table 3-5** list the pin assignment of user push-buttons, switches, and LEDs.

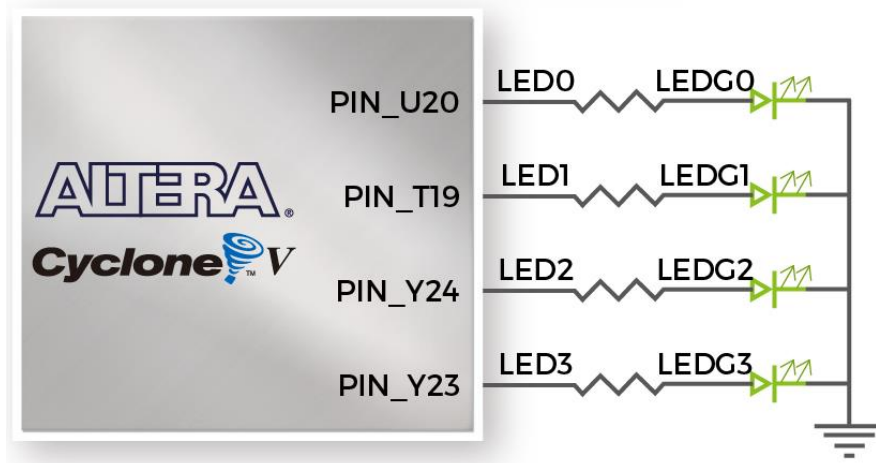

Figure 3-14 Connections between the LEDs and the Cyclone V FPGA

Table 3-3 Pin Assignment of Slide Switches

Switch Name	FPGA Pin No.	Direction	Description	I/O Standard
SW[0]	PIN_G20	Input	Slide Switch [0]	3.3-V LVTTTL
SW[1]	PIN_F21	Input	Slide Switch [1]	3.3-V LVTTTL
SW[2]	PIN_E21	Input	Slide Switch [2]	3.3-V LVTTTL
SW[3]	PIN_H19	Input	Slide Switch [3]	3.3-V LVTTTL

Table 3-4 Pin Assignment of Push-buttons

Key Name	FPGA Pin No.	Direction	Description	I/O Standard
CPU_RESET_n	PIN_AB24	Input	Generate a high logic level when it is not pressed	3.3-V LVTTTL
KEY[0]	PIN_M21	Input	Generate a high logic level when it is not pressed. Four push-buttons (KEY0, KEY1, KEY2 and KEY3) are debounced.	3.3-V LVTTTL
KEY[1]	PIN_K25	Input		3.3-V LVTTTL
KEY[2]	PIN_K26	Input		3.3-V LVTTTL
KEY[3]	PIN_G26	Input		3.3-V LVTTTL

Table 3-5 LED Pin Assignment of LEDs

LED Name	FPGA Pin No.	Direction	Description	I/O Standard
LED[0]	PIN_U20	Output	Drive high logic 1 to I/O pin to turn the LED on. Drive lowh logic 0 to I/O pin to turn the LED off.	3.3-V LVTTTL
LED[1]	PIN_T19	Output		3.3-V LVTTTL
LED[2]	PIN_Y24	Output		3.3-V LVTTTL
LED[3]	PIN_Y23	Output		3.3-V LVTTTL

3.4.2 7-Segment Displays

C5P board has two 7-segment displays. **Figure 3-15** shows the connection of seven segments (common anode) to pins on Cyclone V FPGA. The segment can be turned on or off by applying a low logic level or high logic level from the FPGA, respectively. Each segment in a display is indexed from 0 to 6, with corresponding positions given in **Figure 3-15**. **Table 3-6** shows the pin assignment of FPGA to the 7-segment displays.

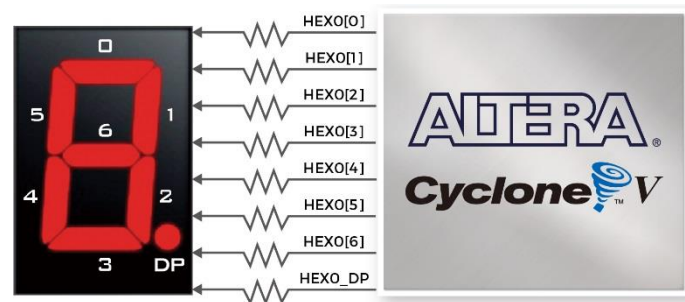

Figure 3-15 Connections between the 7-segment displays and Cyclone V FPGA

Table 3-6 Pin Assignment of 7-segment Displays

HEX Name	FPGA Pin No.	Direction	Description	I/O Standard
HEX0_DP	PIN_AA6	Output	Seven Segment Digit 0 DP	3.3-V LVTTTL
HEX0[0]	PIN_T8	Output	Seven Segment Digit 0[0]	3.3-V LVTTTL
HEX0[1]	PIN_P26	Output	Seven Segment Digit 0[1]	3.3-V

				LVTTL
HEX0[2]	PIN_V8	Output	Seven Segment Digit 0[2]	3.3-V LVTTL
HEX0[3]	PIN_U7	Output	Seven Segment Digit 0[3]	3.3-V LVTTL
HEX0[4]	PIN_U25	Output	Seven Segment Digit 0[4]	3.3-V LVTTL
HEX0[5]	PIN_W8	Output	Seven Segment Digit 0[5]	3.3-V LVTTL
HEX0[6]	PIN_U26	Output	Seven Segment Digit 0[6]	3.3-V LVTTL
HEX1_DP	PIN_V25	Output	Seven Segment Digit 1 DP	3.3-V LVTTL
HEX1[0]	PIN_T7	Output	Seven Segment Digit 1[0]	3.3-V LVTTL
HEX1[1]	PIN_W20	Output	Seven Segment Digit 1[1]	3.3-V LVTTL
HEX1[2]	PIN_AB6	Output	Seven Segment Digit 1[2]	3.3-V LVTTL
HEX1[3]	PIN_AC22	Output	Seven Segment Digit 1[3]	3.3-V LVTTL
HEX1[4]	PIN_Y9	Output	Seven Segment Digit 1[4]	3.3-V LVTTL
HEX1[5]	PIN_W21	Output	Seven Segment Digit 1[5]	3.3-V LVTTL
HEX1[6]	PIN_N25	Output	Seven Segment Digit 1[6]	3.3-V LVTTL

3.4.3 SDRAM Memory

The C5P features 64MB of SDRAM with a single 64MB (32Mx16) SDRAM chip. The chip consists of 16-bit data line, control line, and address line connected to the FPGA. This chip uses the 3.3V LVCMOS signaling standard. Connections between the FPGA and SDRAM are shown in **Figure 3-16**, and the pin assignment is listed in **Table 3-7**.

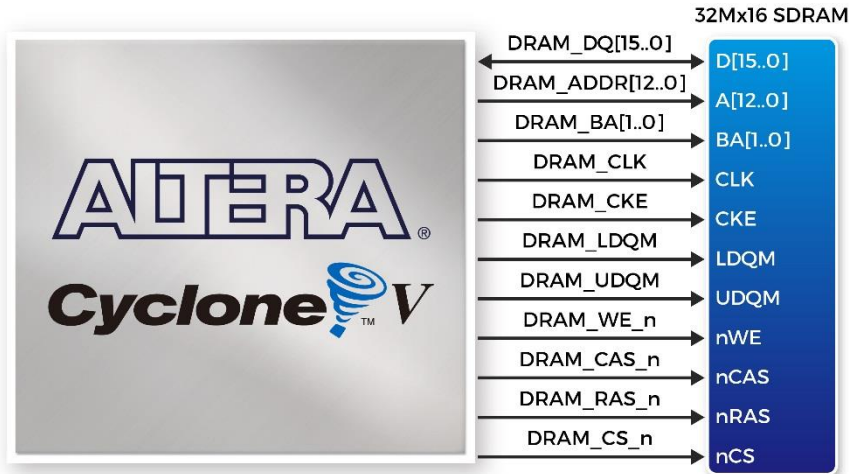

Figure 3-16 Connections between the FPGA and SDRAM

Table 3-7 Pin Assignment of SDRAM

Signal Name	FPGA Pin No.	Direction	Description	I/O Standard
DRAM_CLK	PIN_F26	Output	SDRAM Clock	3.3-V LVTTTL
DRAM_CKE	PIN_E25	Output	SDRAM Clock Enable	3.3-V LVTTTL
DRAM_ADDR[0]	PIN_D26	Output	SDRAM Address[0]	3.3-V LVTTTL
DRAM_ADDR[1]	PIN_H20	Output	SDRAM Address[1]	3.3-V LVTTTL
DRAM_ADDR[2]	PIN_F23	Output	SDRAM Address[2]	3.3-V LVTTTL
DRAM_ADDR[3]	PIN_G22	Output	SDRAM Address[3]	3.3-V LVTTTL
DRAM_ADDR[4]	PIN_B25	Output	SDRAM Address[4]	3.3-V LVTTTL
DRAM_ADDR[5]	PIN_D22	Output	SDRAM Address[5]	3.3-V LVTTTL
DRAM_ADDR[6]	PIN_C25	Output	SDRAM Address[6]	3.3-V LVTTTL
DRAM_ADDR[7]	PIN_E23	Output	SDRAM Address[7]	3.3-V LVTTTL
DRAM_ADDR[8]	PIN_B26	Output	SDRAM Address[8]	3.3-V LVTTTL
DRAM_ADDR[9]	PIN_E24	Output	SDRAM Address[9]	3.3-V LVTTTL
DRAM_ADDR[10]	PIN_D25	Output	SDRAM Address[10]	3.3-V LVTTTL
DRAM_ADDR[11]	PIN_M26	Output	SDRAM Address[11]	3.3-V LVTTTL
DRAM_ADDR[12]	PIN_M25	Output	SDRAM Address[12]	3.3-V LVTTTL
DRAM_BA[0]	PIN_J20	Output	SDRAM Bank Address[0]	3.3-V LVTTTL
DRAM_BA[1]	PIN_H22	Output	SDRAM Bank Address[1]	3.3-V LVTTTL
DRAM_DQ[0]	PIN_L24	Inout	SDRAM Data[0]	3.3-V LVTTTL
DRAM_DQ[1]	PIN_M24	Inout	SDRAM Data[1]	3.3-V LVTTTL
DRAM_DQ[2]	PIN_N23	Inout	SDRAM Data[2]	3.3-V LVTTTL
DRAM_DQ[3]	PIN_K23	Inout	SDRAM Data[3]	3.3-V LVTTTL

DRAM_DQ[4]	PIN_H24	Inout	SDRAM Data[4]	3.3-V LVTTTL
DRAM_DQ[5]	PIN_J23	Inout	SDRAM Data[5]	3.3-V LVTTTL
DRAM_DQ[6]	PIN_K24	Inout	SDRAM Data[6]	3.3-V LVTTTL
DRAM_DQ[7]	PIN_L22	Inout	SDRAM Data[7]	3.3-V LVTTTL
DRAM_DQ[8]	PIN_G25	Inout	SDRAM Data[8]	3.3-V LVTTTL
DRAM_DQ[9]	PIN_G24	Inout	SDRAM Data[9]	3.3-V LVTTTL
DRAM_DQ[10]	PIN_H25	Inout	SDRAM Data[10]	3.3-V LVTTTL
DRAM_DQ[11]	PIN_J21	Inout	SDRAM Data[11]	3.3-V LVTTTL
DRAM_DQ[12]	PIN_L23	Inout	SDRAM Data[12]	3.3-V LVTTTL
DRAM_DQ[13]	PIN_K21	Inout	SDRAM Data[13]	3.3-V LVTTTL
DRAM_DQ[14]	PIN_N24	Inout	SDRAM Data[14]	3.3-V LVTTTL
DRAM_DQ[15]	PIN_M22	Inout	SDRAM Data[15]	3.3-V LVTTTL
DRAM_LDQM	PIN_H23	Output	DQ[7:0] SDRAM Data Mask	3.3-V LVTTTL
DRAM_UDQM	PIN_F24	Output	DQ[15:8] SDRAM Data Mask	3.3-V LVTTTL
DRAM_CS_n	PIN_F22	Output	SDRAM Chip Select	3.3-V LVTTTL
DRAM_WE_n	PIN_J25	Output	SDRAM Write Enable	3.3-V LVTTTL
DRAM_CAS_n	PIN_J26	Output	SDRAM Column Address Strobe	3.3-V LVTTTL
DRAM_RAS_n	PIN_E26	Output	SDRAM Row Address Strobe	3.3-V LVTTTL

3.4.4 DDR3 Memory

C5P supports 1GB of DDR3 SDRAM comprising of two x16 bit DDR3 devices. The signals are connected to the dedicated Hard Memory Controller for FPGA I/O banks and the target speed is 400MHz. **Figure 3-17** shows the connections between the DDR3 and Cyclone V FPGA. **Table 3-8** lists the pin assignment of the DDR3 and its description with I/O standard.

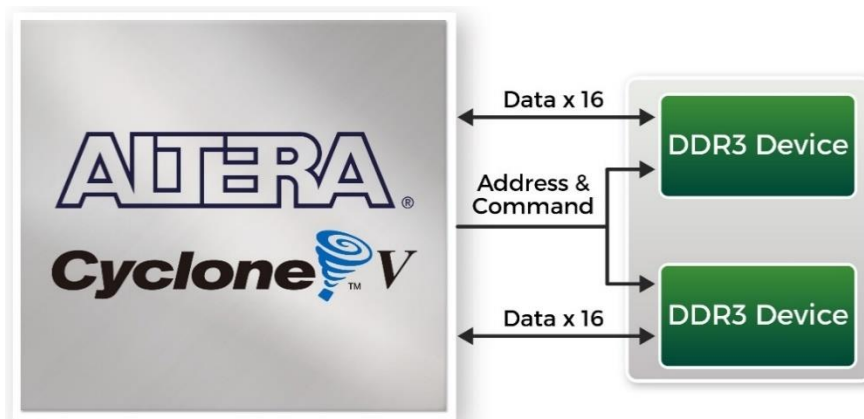

Figure 3-17 Connections between FPGA and DDR3

Table 3-8 Pin Assignment of DDR3 Memory

Signal Name	FPGA Pin No.	Direction	Description	I/O Standard
DDR3_ADDR[0]	PIN_AE6	Output	DDR3 Address[0]	SSTL-15 Class I
DDR3_ADDR[1]	PIN_AF6	Output	DDR3 Address[1]	SSTL-15 Class I
DDR3_ADDR[2]	PIN_AF7	Output	DDR3 Address[2]	SSTL-15 Class I
DDR3_ADDR[3]	PIN_AF8	Output	DDR3 Address[3]	SSTL-15 Class I
DDR3_ADDR[4]	PIN_U10	Output	DDR3 Address[4]	SSTL-15 Class I
DDR3_ADDR[5]	PIN_U11	Output	DDR3 Address[5]	SSTL-15 Class I
DDR3_ADDR[6]	PIN_AE9	Output	DDR3 Address[6]	SSTL-15 Class I
DDR3_ADDR[7]	PIN_AF9	Output	DDR3 Address[7]	SSTL-15 Class I
DDR3_ADDR[8]	PIN_AB12	Output	DDR3 Address[8]	SSTL-15 Class I
DDR3_ADDR[9]	PIN_AB11	Output	DDR3 Address[9]	SSTL-15 Class I
DDR3_ADDR[10]	PIN_AC9	Output	DDR3 Address[10]	SSTL-15 Class I
DDR3_ADDR[11]	PIN_AC8	Output	DDR3 Address[11]	SSTL-15 Class I
DDR3_ADDR[12]	PIN_AB10	Output	DDR3 Address[12]	SSTL-15 Class I
DDR3_ADDR[13]	PIN_AC10	Output	DDR3 Address[13]	SSTL-15 Class I
DDR3_ADDR[14]	PIN_W11	Output	DDR3 Address[14]	SSTL-15 Class I
DDR3_BA[0]	PIN_V10	Output	DDR3 Bank Address[0]	SSTL-15 Class I
DDR3_BA[1]	PIN_AD8	Output	DDR3 Bank Address[1]	SSTL-15 Class I
DDR3_BA[2]	PIN_AE8	Output	DDR3 Bank Address[2]	SSTL-15 Class I
DDR3_CK_p	PIN_N10	Output	DDR3 Clock p	Differential 1.5-V SSTL Class I
DDR3_CK_n	PIN_P10	Output	DDR3 Clock n	Differential 1.5-V SSTL Class I
DDR3_CKE	PIN_AF14	Output	DDR3 Clock Enable	SSTL-15 Class I
DDR3_DQS_p[0]	PIN_V13	Inout	DDR3 Data Strobe p[0]	Differential 1.5-V SSTL Class I
DDR3_DQS_p[1]	PIN_U14	Inout	DDR3 Data Strobe p[1]	Differential 1.5-V SSTL Class I
DDR3_DQS_p[2]	PIN_V15	Inout	DDR3 Data Strobe p[2]	Differential 1.5-V SSTL Class I
DDR3_DQS_p[3]	PIN_W16	Inout	DDR3 Data Strobe p[3]	Differential 1.5-V SSTL Class I
DDR3_DQS_n[0]	PIN_W13	Inout	DDR3 Data Strobe n[0]	Differential 1.5-V

				SSTL Class I
DDR3_DQS_n[1]	PIN_V14	Inout	DDR3 Data Strobe n[1]	Differential 1.5-V SSTL Class I
DDR3_DQS_n[2]	PIN_W15	Inout	DDR3 Data Strobe n[2]	Differential 1.5-V SSTL Class I
DDR3_DQS_n[3]	PIN_W17	Inout	DDR3 Data Strobe n[3]	Differential 1.5-V SSTL Class I
DDR3_DQ[0]	PIN_AA14	Inout	DDR3 Data[0]	SSTL-15 Class I
DDR3_DQ[1]	PIN_Y14	Inout	DDR3 Data[1]	SSTL-15 Class I
DDR3_DQ[2]	PIN_AD11	Inout	DDR3 Data[2]	SSTL-15 Class I
DDR3_DQ[3]	PIN_AD12	Inout	DDR3 Data[3]	SSTL-15 Class I
DDR3_DQ[4]	PIN_Y13	Inout	DDR3 Data[4]	SSTL-15 Class I
DDR3_DQ[5]	PIN_W12	Inout	DDR3 Data[5]	SSTL-15 Class I
DDR3_DQ[6]	PIN_AD10	Inout	DDR3 Data[6]	SSTL-15 Class I
DDR3_DQ[7]	PIN_AF12	Inout	DDR3 Data[7]	SSTL-15 Class I
DDR3_DQ[8]	PIN_AC15	Inout	DDR3 Data[8]	SSTL-15 Class I
DDR3_DQ[9]	PIN_AB15	Inout	DDR3 Data[9]	SSTL-15 Class I
DDR3_DQ[10]	PIN_AC14	Inout	DDR3 Data[10]	SSTL-15 Class I
DDR3_DQ[11]	PIN_AF13	Inout	DDR3 Data[11]	SSTL-15 Class I
DDR3_DQ[12]	PIN_AB16	Inout	DDR3 Data[12]	SSTL-15 Class I
DDR3_DQ[13]	PIN_AA16	Inout	DDR3 Data[13]	SSTL-15 Class I
DDR3_DQ[14]	PIN_AE14	Inout	DDR3 Data[14]	SSTL-15 Class I
DDR3_DQ[15]	PIN_AF18	Inout	DDR3 Data[15]	SSTL-15 Class I
DDR3_DQ[16]	PIN_AD16	Inout	DDR3 Data[16]	SSTL-15 Class I
DDR3_DQ[17]	PIN_AD17	Inout	DDR3 Data[17]	SSTL-15 Class I
DDR3_DQ[18]	PIN_AC18	Inout	DDR3 Data[18]	SSTL-15 Class I
DDR3_DQ[19]	PIN_AF19	Inout	DDR3 Data[19]	SSTL-15 Class I
DDR3_DQ[20]	PIN_AC17	Inout	DDR3 Data[20]	SSTL-15 Class I
DDR3_DQ[21]	PIN_AB17	Inout	DDR3 Data[21]	SSTL-15 Class I
DDR3_DQ[22]	PIN_AF21	Inout	DDR3 Data[22]	SSTL-15 Class I
DDR3_DQ[23]	PIN_AE21	Inout	DDR3 Data[23]	SSTL-15 Class I
DDR3_DQ[24]	PIN_AE15	Inout	DDR3 Data[24]	SSTL-15 Class I
DDR3_DQ[25]	PIN_AE16	Inout	DDR3 Data[25]	SSTL-15 Class I
DDR3_DQ[26]	PIN_AC20	Inout	DDR3 Data[26]	SSTL-15 Class I
DDR3_DQ[27]	PIN_AD21	Inout	DDR3 Data[27]	SSTL-15 Class I
DDR3_DQ[28]	PIN_AF16	Inout	DDR3 Data[28]	SSTL-15 Class I
DDR3_DQ[29]	PIN_AF17	Inout	DDR3 Data[29]	SSTL-15 Class I

DDR3_DQ[30]	PIN_AD23	Inout	DDR3 Data[30]	SSTL-15 Class I
DDR3_DQ[31]	PIN_AF23	Inout	DDR3 Data[31]	SSTL-15 Class I
DDR3_DM[0]	PIN_AF11	Output	DDR3 Data Mask[0]	SSTL-15 Class I
DDR3_DM[1]	PIN_AE18	Output	DDR3 Data Mask[1]	SSTL-15 Class I
DDR3_DM[2]	PIN_AE20	Output	DDR3 Data Mask[2]	SSTL-15 Class I
DDR3_DM[3]	PIN_AE24	Output	DDR3 Data Mask[3]	SSTL-15 Class I
DDR3_CS_n	PIN_R11	Output	DDR3 Chip Select	SSTL-15 Class I
DDR3_WE_n	PIN_T9	Output	DDR3 Write Enable	SSTL-15 Class I
DDR3_CAS_n	PIN_W10	Output	DDR3 Column Address Strobe	SSTL-15 Class I
DDR3_RAS_n	PIN_Y10	Output	DDR3 Row Address Strobe	SSTL-15 Class I
DDR3_RESET_n	PIN_AE19	Output	DDR3 Reset	SSTL-15 Class I
DDR3_ODT	PIN_AD13	Output	DDR3 On-die Termination	SSTL-15 Class I
DDR3_RZQ	PIN_AE11	Input	External reference ball for output drive calibration	1.5 V

3.4.5 UART to USB

The C5P board has one UART interface. The physical interface is implemented by UART-USB onboard bridge from a CP2102N chip to the host with a USB Mini-B connector. More information about the chip is available on the manufacturer's website, or in the directory \Datasheets\UART TO USB of C5P system CD. **Figure 3-18** shows the connections between the FPGA, CP2102N chip, and the USB Mini-B connector. **Table 3-9** lists the pin assignment of UART interface connected to the FPGA.

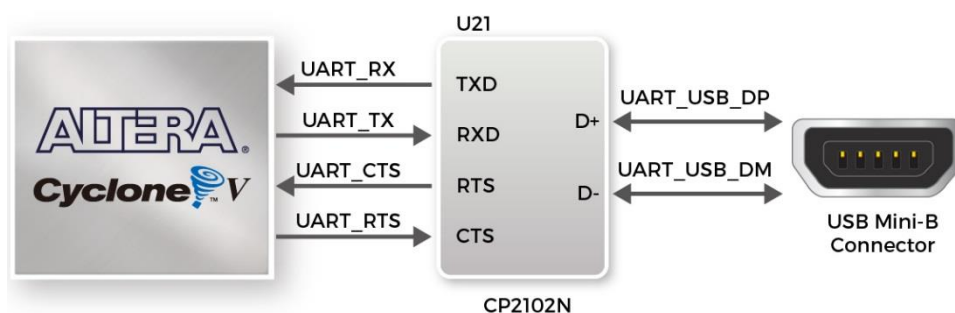

Figure 3-18 Connections between the FPGA, CP2102N chip and USB Mini-B connector

Table 3-9 Pin Assignment of UART Interface

Signal Name	FPGA Pin No.	Direction	Description	I/O Standard
UART_TX	PIN_P21	Output	UART Transmitter	3.3-V LVTTTL
UART_RX	PIN_P22	Input	UART Receiver	3.3-V LVTTTL
UART_CTS	PIN_W25	Input	UART Clear to Send	3.3-V LVTTTL
UART_RTS	PIN_W26	Output	UART Request to Send	3.3-V LVTTTL

3.4.6 Arduino Uno R3 Expansion Header

The C5P provides provides Arduino Uno revision 3 compatibility expansion header which comes with four independent headers. The expansion header has 17 user pins (16pins GPIO and 1pin Reset) connected directly to Cyclone V GX FPGA. 8-Pin Analog input connects to the ADC, and also provides DC +5V (VCC5), DC +3.3V (VCC3P3 and IOREF), and three GND pins. Please refer to **Figure 3-19** for detailed pin-out information. The blue font represents the Arduino Uno R3 board pin-out definition.

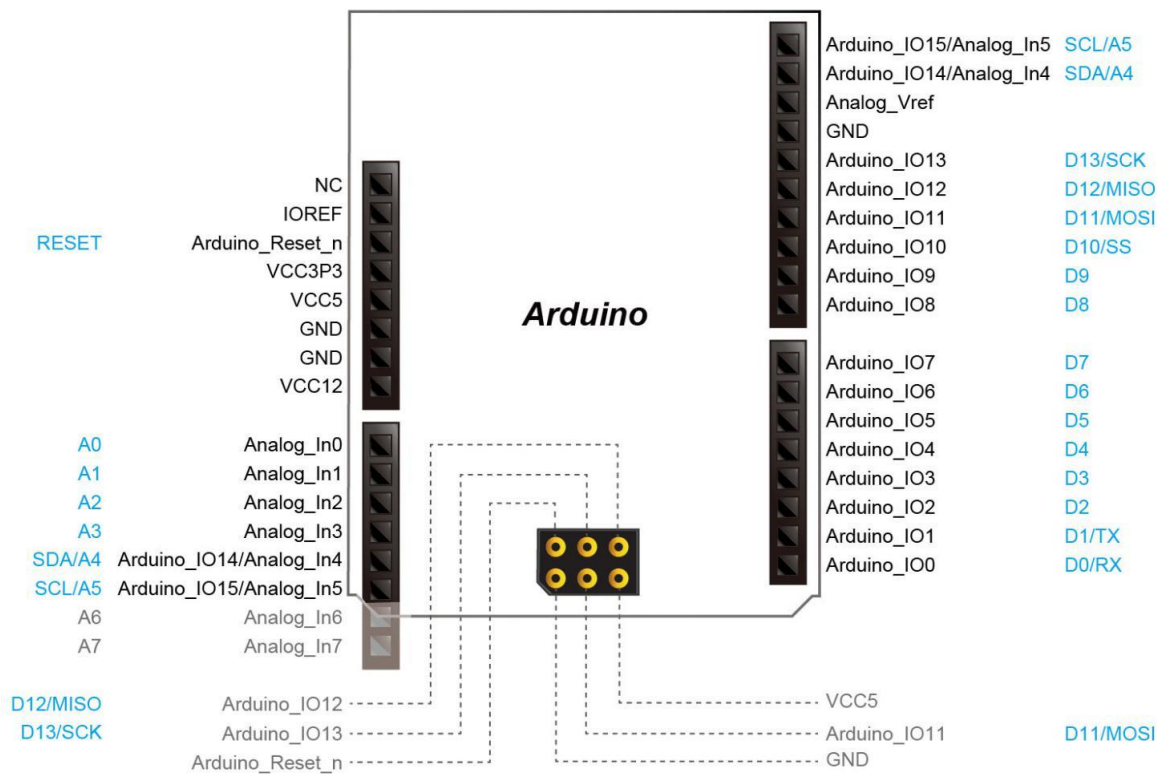

Figure 3-19 All the pin-out signal name of the Arduino Uno connector

The 16 GPIO pins are provided to the Arduino Header for digital I/O. Among these 16 GPIO pins, two pins possess both analog and digital functionalities according to the Arduino Header settings. The MCU on the Arduino main board can select either the analog or digital function. Unfortunately, this selection can't be done with the FPGA and users would have to use the corresponding jumpers to make the selection. **Table 3-10** lists all the pin assignments of the Arduino Uno connector (digital), signal names relative to Cyclone V GX FPGA.

Table 3-10 Pin Assignments for Arduino Uno Expansion Header connector

Signal Name	FPGA Pin No.	Direction	Description	I/O Standard
ADC_SCK	PIN_R26	Output	Serial Data Clock	3.3-V LVTTTL
ADC_SDO	PIN_AB26	Input	Serial Data Out (ADC to FPGA)	3.3-V LVTTTL
ADC_SDI	PIN_AA26	Output	Serial Data Input (FPGA to ADC)	3.3-V LVTTTL
ADC_CONVST	PIN_T26	Output	Conversion Start	3.3-V LVTTTL
ARD_IO[0]	PIN_Y26	Inout	Arduino IO0	3.3-V LVTTTL
ARD_IO[1]	PIN_V23	Inout	Arduino IO1	3.3-V LVTTTL
ARD_IO[2]	PIN_V24	Inout	Arduino IO2	3.3-V LVTTTL
ARD_IO[3]	PIN_U24	Inout	Arduino IO3	3.3-V LVTTTL
ARD_IO[4]	PIN_T24	Inout	Arduino IO4	3.3-V LVTTTL
ARD_IO[5]	PIN_T23	Inout	Arduino IO5	3.3-V LVTTTL
ARD_IO[6]	PIN_T22	Inout	Arduino IO6	3.3-V LVTTTL
ARD_IO[7]	PIN_R24	Inout	Arduino IO7	3.3-V LVTTTL
ARD_IO[8]	PIN_P20	Inout	Arduino IO8	3.3-V LVTTTL
ARD_IO[9]	PIN_R23	Inout	Arduino IO9	3.3-V LVTTTL
ARD_IO[10]	PIN_R25	Inout	Arduino IO10	3.3-V LVTTTL
ARD_IO[11]	PIN_P23	Inout	Arduino IO11	3.3-V LVTTTL
ARD_IO[12]	PIN_AC25	Inout	Arduino IO12	3.3-V LVTTTL
ARD_IO[13]	PIN_AD25	Inout	Arduino IO13	3.3-V LVTTTL
ARD_IO[14]	PIN_AB25	Inout	Arduino IO14	3.3-V LVTTTL
ARD_IO[15]	PIN_AA24	Inout	Arduino IO15	3.3-V LVTTTL

Besides 16 pins for digital GPIO, there are also 8 analog inputs on the Arduino Uno R3 Expansion Header. Consequently, we use ADC LTC2308 from Linear Technology on the board for possible future analog-to-digital applications.

The LTC2308 is a low noise, 500ksps, 8-channel, 12-bit ADC with a SPI/MICROWIRE

compatible serial interface. This ADC includes an internal reference and a fully differential sample-and-hold circuit to reduce common mode noise. The internal conversion clock allows the external serial output data clock (SCK) to operate at any frequency up to 40MHz.

The LTC2308 is controlled via a serial SPI bus interface, which is connected to pins on the Cyclone V GX FPGA. A schematic diagram of the ADC circuitry is shown in **Figure 3-20**. Detailed information for using the LTC2308 is available on its datasheet, which can be found on the manufacturer’s website, or under the Datasheets\ADC folder of the C5P System CD.

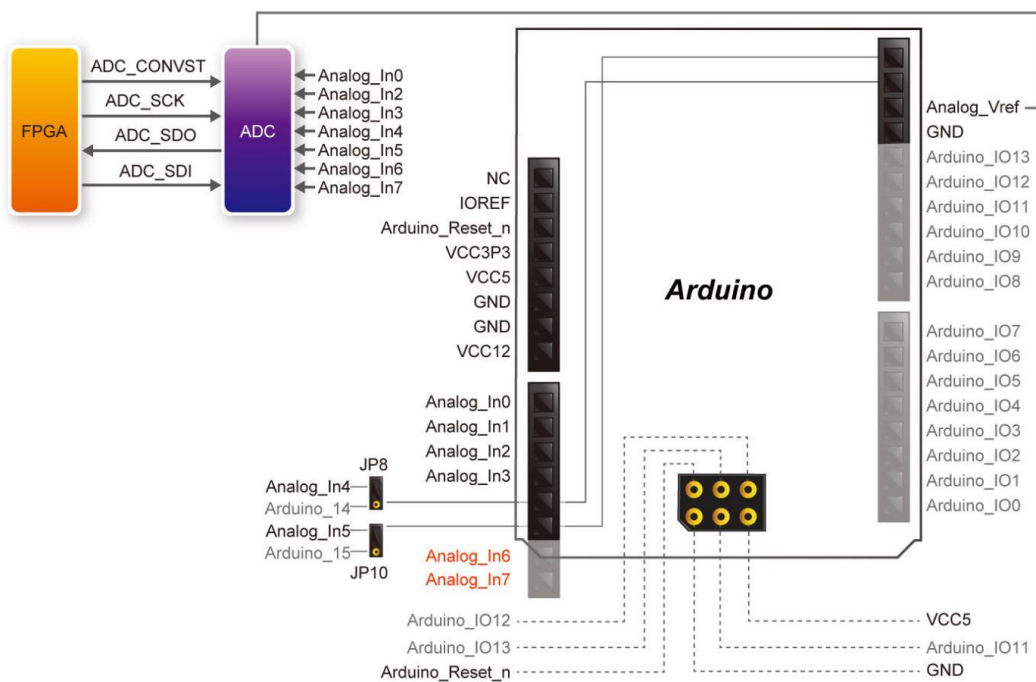

Figure 3-20 Connection and pin assignments of Arduino analog input (ADC)

When users wish to use Analog_IN4(AD4) and Analog_IN5(AD5), they would need to make their choices through corresponding jumpers. This is because following the Arduino Header definition, these two pins possess both analog/digital functionalities and can be controlled by the MCU on the Arduino main board. However, this can't be done with the FPGA. Therefore, users have to use the corresponding jumpers to make their selection.

Table 3-11 lists the settings to select the Arduino interface as Digital I/O mode. **Table 3-12** lists the settings to select the Arduino interface as Analog I/O mode.

Table 3-11 Select Arduino expansion header for Digital I/O Mode





Function	Jump Position	Jump Position	Board picture
Arduino Arduino_IO14 (SDA)	JP8.2-JP8.3	 <p>JP8 3 2 1</p>	
Arduino Arduino_IO15 (SCL)	JP10.2-JP10.3	 <p>1 2 3 JP10</p>	

Table 3-12 Select Analog input (Analog_IN4/Analog_IN5)

Function	Jump Position	Jump Position	Board picture
Use Arduino Analog_IN4 (AD4)	JP8.1-JP8.2	 <p>JP8 3 2 1</p>	
Use Arduino Analog_IN5 (AD5)	JP10.1-JP10.2	 <p>1 2 3 JP10</p>	

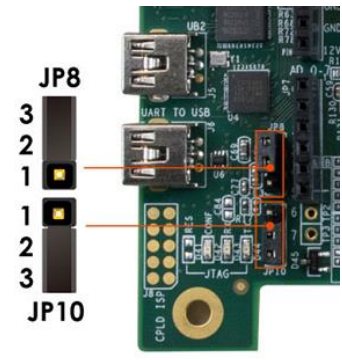
Besides, there are no components pre-soldered on the Analog_IN6 and Analog_IN7. Therefore, if users wish to use these two inputs, they would need to solder components such as female headers before it can be connected to the object to be measured.

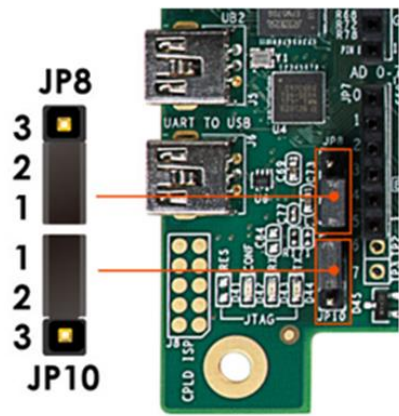
Note: We urge users to carefully install Arduino Shield after installing parts on Analog_IN6(7) in order to avoid shift when inserting the shield board.

Table 3-13 lists the ADC SPI Interface pin assignments, signal names relative to the Cyclone V GX device.

Table 3-13 ADC SPI Interface Pin Assignments and Signal Names

Signal Name	Description	I/O Standard	Cyclone V GX Pin Number
ADC_CONVST	Conversion Start	1.2-V	PIN_T26
ADC_SCK	Serial Data Clock	1.2-V	PIN_R26
ADC_SDI	Serial Data Input (FPGA to ADC)	1.2-V	PIN_AA26
ADC_SDO	Serial Data Out (ADC to FPGA)	1.2-V	PIN_AB26

3.4.7 2x20 GPIO Expansion Header

The C5P has two 40-pin expansion headers. Each header has 36 user pins connected directly to the Cyclone V FPGA. It also comes with DC +5V (VCC5), DC +3.3V (VCC3P3), and two GND pins. The maximum power consumption allowed for a daughter card connected to one GPIO ports is shown in **Table 3-14**.

Table 3-14 Voltage and Max. Current Limit of Expansion Headers

Supplied Voltage	Max. Current Limit
5V	1A
3.3V	1.5A

Each GPIO header has eight TX and eight channels. The voltage level of the I/O pins on the expansion headers can be adjusted to 3.3V, 2.5V, 1.8V, or 1.5V by using JP1 (The default value is 3.3V). Because the expansion I/Os are connected to Bank 7A and 8A of the FPGA, and the VCCIO voltage of these banks (VCCIO7A and VCCIO8A) is controlled by the header JP1, users can use a jumper to select the input voltage of VCCIO7A and VCCIO8A to 3.3V, 2.5V, 1.8V, and 1.5V to control the voltage level of the I/O pins. **Table 3-15** lists the jumper settings of the JP1. **Figure 3-21** and **Figure 3-22** show the jumper setting for shorting pin 5 and pin 6 and shorting pin 7 and pin 8 of JP1.

Table 3-15 Voltage Level Setting of the Expansion Headers Using JP1

JP1 Jumper Settings	Supplied Voltage to VCCIO7A and VCCIO8A	IO Voltage of GPIO Expansion Headers
Short pin 1 and pin 2	1.5V	1.5V
Short pin 3 and pin 4	1.8V	1.8V
Short pin 5 and pin 6	2.5V	2.5V

Short pin 7 and pin 8	3.3V	3.3V (default)
-----------------------	------	----------------

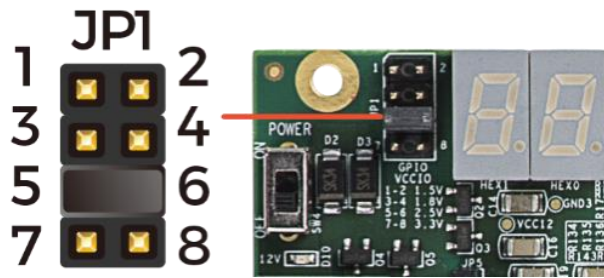

Figure 3-21 Short pin5 and pin 6 of JP1

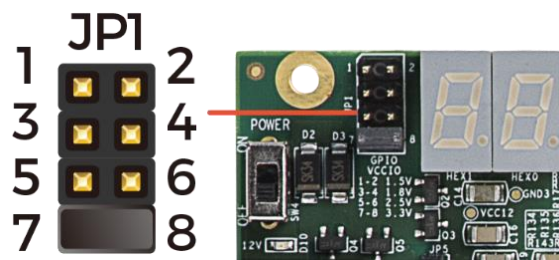

Figure 3-22 Short pin 7 and pin 8 of JP1

The GPIO I/O pins support 16-channel LVDS transmission standard. The maximum transmission rate of loopback test is up to 840 Mbps. The I/O voltage standard of LVDS transmission needs to be set at 2.5V.

Each pin on the expansion headers is connected to two diodes and a resistor that provides protection against high and low voltages. **Figure 3-23** shows the protection circuitry for 36 data pins. **Table 3-16** shows all the pin assignments of the GPIO expansion headers.

GPIO 0 (JP3)					GPIO 1 (JP4)						
PIN_G15	GPIO_0[0]	1	2	GPIO_0[1]	PIN_C9	PIN_L8	GPIO_1[0]	1	2	GPIO_1[1]	PIN_A7
PIN_G14	GPIO_0[2]	3	4	GPIO_0[3]	PIN_B9	PIN_K9	GPIO_1[2]	3	4	GPIO_1[3]	PIN_B7
PIN_B24	GPIO_0[4]	5	6	GPIO_0[5]	PIN_D10	PIN_L7	GPIO_1[4]	5	6	GPIO_1[5]	PIN_A5
PIN_A24	GPIO_0[6]	7	8	GPIO_0[7]	PIN_C10	PIN_K6	GPIO_1[6]	7	8	GPIO_1[7]	PIN_B6
PIN_G16	GPIO_0[8]	9	10	GPIO_0[9]	PIN_H13	PIN_M9	GPIO_1[8]	9	10	GPIO_1[9]	PIN_L9
5V		11	12	GND			5V	11	12	GND	
PIN_C14	GPIO_0[10]	13	14	GPIO_0[11]	PIN_B15	PIN_K8	GPIO_1[10]	13	14	GPIO_1[11]	PIN_D6
PIN_D15	GPIO_0[12]	15	16	GPIO_0[13]	PIN_C15	PIN_J8	GPIO_1[12]	15	16	GPIO_1[13]	PIN_E6
PIN_D21	GPIO_0[14]	17	18	GPIO_0[15]	PIN_A19	PIN_H8	GPIO_1[14]	17	18	GPIO_1[15]	PIN_G7
PIN_D20	GPIO_0[16]	19	20	GPIO_0[17]	PIN_A18	PIN_H9	GPIO_1[16]	19	20	GPIO_1[17]	PIN_F7
PIN_E20	GPIO_0[18]	21	22	GPIO_0[19]	PIN_B22	PIN_H10	GPIO_1[18]	21	22	GPIO_1[19]	PIN_A12
PIN_E19	GPIO_0[20]	23	24	GPIO_0[21]	PIN_A21	PIN_G10	GPIO_1[20]	23	24	GPIO_1[21]	PIN_B11
PIN_E18	GPIO_0[22]	25	26	GPIO_0[23]	PIN_C23	PIN_M11	GPIO_1[22]	25	26	GPIO_1[23]	PIN_B12
PIN_F18	GPIO_0[24]	27	28	GPIO_0[25]	PIN_C22	PIN_L11	GPIO_1[24]	27	28	GPIO_1[25]	PIN_A13
3.3V		29	30	GND			3.3V	29	30	GND	
PIN_H14	GPIO_0[26]	31	32	GPIO_0[27]	PIN_G17	PIN_A17	GPIO_1[26]	31	32	GPIO_1[27]	PIN_A16
PIN_J12	GPIO_0[28]	33	34	GPIO_0[29]	PIN_C20	PIN_E13	GPIO_1[28]	33	34	GPIO_1[29]	PIN_C13
PIN_J11	GPIO_0[30]	35	36	GPIO_0[31]	PIN_B19	PIN_D13	GPIO_1[30]	35	36	GPIO_1[31]	PIN_C12
PIN_N12	GPIO_0[32]	37	38	GPIO_0[33]	PIN_C17	PIN_G12	GPIO_1[32]	37	38	GPIO_1[33]	PIN_H7
PIN_M12	GPIO_0[34]	39	40	GPIO_0[35]	PIN_B17	PIN_F12	GPIO_1[34]	39	40	GPIO_1[35]	PIN_J7

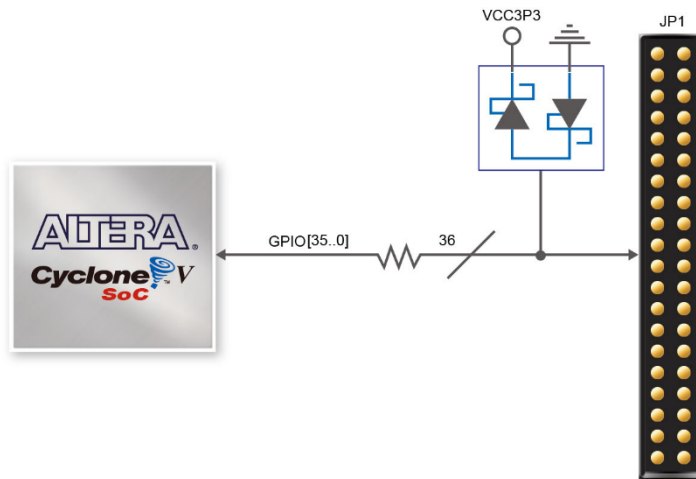

Figure 3-23 Connections between the GPIO connector and Cyclone V FPGA

Table 3-16 Pin Assignments for Expansion Headers

Signal Name	FPGA Pin No.	Direction	Description	I/O Standard
GPIO_0[0]	PIN_G15	inout	GPIO 0 DATA0/LVDS RX0_p	Depend on JP1
GPIO_0[1]	PIN_C9	inout	GPIO 0 DATA1/LVDS TX0_p	Depend on JP1

GPIO_0[2]	PIN_G14	inout	GPIO 0 DATA2/LVDS RX0_n	Depend on JP1
GPIO_0[3]	PIN_B9	inout	GPIO 0 DATA3/LVDS TX0_n	Depend on JP1
GPIO_0[4]	PIN_B24	inout	GPIO 0 DATA4/LVDS RX1_p	Depend on JP1
GPIO_0[5]	PIN_D10	inout	GPIO 0 DATA5/LVDS TX1_p	Depend on JP1
GPIO_0[6]	PIN_A24	inout	GPIO 0 DATA6/LVDS RX1_n	Depend on JP1
GPIO_0[7]	PIN_C10	inout	GPIO 0 DATA7/LVDS TX1_n	Depend on JP1
GPIO_0[8]	PIN_G16	inout	GPIO 0 DATA8	Depend on JP1
GPIO_0[9]	PIN_H13	inout	GPIO 0 DATA9	Depend on JP1
GPIO_0[10]	PIN_C14	inout	GPIO 0 DATA10/LVDS RX2_p	Depend on JP1
GPIO_0[11]	PIN_B15	inout	GPIO 0 DATA11/LVDS TX2_p	Depend on JP1
GPIO_0[12]	PIN_D15	inout	GPIO 0 DATA12/LVDS_RX2_n	Depend on JP1
GPIO_0[13]	PIN_C15	inout	GPIO 0 DATA13/LVDS_TX2_n	Depend on JP1
GPIO_0[14]	PIN_D21	inout	GPIO 0 DATA14/LVDS RX3_p	Depend on JP1
GPIO_0[15]	PIN_A19	inout	GPIO 0 DATA15/LVDS TX3_p	Depend on JP1
GPIO_0[16]	PIN_D20	inout	GPIO 0 DATA16/LVDS_RX3_n	Depend on JP1
GPIO_0[17]	PIN_A18	inout	GPIO 0 DATA17/LVDS TX3_n	Depend on JP1
GPIO_0[18]	PIN_E20	inout	GPIO 0 DATA18/LVDS RX4_p	Depend on JP1
GPIO_0[19]	PIN_B22	inout	GPIO 0 DATA19/LVDS TX4_p	Depend on JP1
GPIO_0[20]	PIN_E19	inout	GPIO 0 DATA20/LVDS_RX4_n	Depend on JP1
GPIO_0[21]	PIN_A21	inout	GPIO 0 DATA21/LVDS_TX4_n	Depend on JP1
GPIO_0[22]	PIN_E18	inout	GPIO 0 DATA22/LVDS RX5_p	Depend on JP1
GPIO_0[23]	PIN_C23	inout	GPIO 0 DATA23/LVDS TX5_p	Depend on JP1
GPIO_0[24]	PIN_F18	inout	GPIO 0 DATA24/LVDS_RX5_n	Depend on JP1
GPIO_0[25]	PIN_C22	inout	GPIO 0 DATA25/LVDS TX5_n	Depend on JP1
GPIO_0[26]	PIN_H14	inout	GPIO 0 DATA26	Depend on JP1
GPIO_0[27]	PIN_G17	inout	GPIO 0 DATA27	Depend on JP1
GPIO_0[28]	PIN_J12	inout	GPIO 0 DATA28/LVDS RX6_p	Depend on JP1
GPIO_0[29]	PIN_C20	inout	GPIO 0 DATA29/LVDS TX6_p	Depend on JP1
GPIO_0[30]	PIN_J11	inout	GPIO 0 DATA30/LVDS RX6_n	Depend on JP1
GPIO_0[31]	PIN_B19	inout	GPIO 0 DATA31/LVDS TX6_n	Depend on JP1
GPIO_0[32]	PIN_N12	inout	GPIO 0 DATA32/LVDS RX7_p	Depend on JP1
GPIO_0[33]	PIN_C17	inout	GPIO 0 DATA33/LVDS TX7_p	Depend on JP1
GPIO_0[34]	PIN_M12	inout	GPIO 0 DATA34/LVDS RX7_n	Depend on JP1
GPIO_0[35]	PIN_B17	inout	GPIO 0 DATA35/LVDS TX7_n	Depend on JP1
GPIO_1[0]	PIN_L8	inout	GPIO 1 DATA0/LVDS RX0_p	Depend on JP1
GPIO_1[1]	PIN_A7	inout	GPIO 1 DATA1/LVDS TX0_p	Depend on JP1
GPIO_1[2]	PIN_K9	inout	GPIO 1 DATA2/LVDS RX0_n	Depend on JP1

GPIO_1[3]	PIN_B7	inout	GPIO 1 DATA3/LVDS TX0_n	Depend on JP1
GPIO_1[4]	PIN_L7	inout	GPIO 1 DATA4/LVDS RX1_p	Depend on JP1
GPIO_1[5]	PIN_A5	inout	GPIO 1 DATA5/LVDS TX1_p	Depend on JP1
GPIO_1[6]	PIN_K6	inout	GPIO 1 DATA6/LVDS RX1_n	Depend on JP1
GPIO_1[7]	PIN_B6	inout	GPIO 1 DATA7/LVDS TX1_n	Depend on JP1
GPIO_1[8]	PIN_M9	inout	GPIO 1 DATA8	Depend on JP1
GPIO_1[9]	PIN_L9	inout	GPIO 1 DATA9	Depend on JP1
GPIO_1[10]	PIN_K8	inout	GPIO 1 DATA10/LVDS RX2_p	Depend on JP1
GPIO_1[11]	PIN_D6	inout	GPIO 1 DATA11/LVDS TX2_p	Depend on JP1
GPIO_1[12]	PIN_J8	inout	GPIO 1 DATA12/LVDS_RX2_n	Depend on JP1
GPIO_1[13]	PIN_E6	inout	GPIO 1 DATA13/LVDS_TX2_n	Depend on JP1
GPIO_1[14]	PIN_H8	inout	GPIO 1 DATA14/LVDS RX3_p	Depend on JP1
GPIO_1[15]	PIN_G7	inout	GPIO 1 DATA15/LVDS TX3_p	Depend on JP1
GPIO_1[16]	PIN_H9	inout	GPIO 1 DATA16/LVDS_RX3_n	Depend on JP1
GPIO_1[17]	PIN_F7	inout	GPIO 1 DATA17/LVDS TX3_n	Depend on JP1
GPIO_1[18]	PIN_H10	inout	GPIO 1 DATA18/LVDS RX4_p	Depend on JP1
GPIO_1[19]	PIN_A12	inout	GPIO 1 DATA19/LVDS TX4_p	Depend on JP1
GPIO_1[20]	PIN_G10	inout	GPIO 1 DATA20/LVDS_RX4_n	Depend on JP1
GPIO_1[21]	PIN_B11	inout	GPIO 1 DATA21/LVDS_TX4_n	Depend on JP1
GPIO_1[22]	PIN_M11	inout	GPIO 1 DATA22/LVDS RX5_p	Depend on JP1
GPIO_1[23]	PIN_B12	inout	GPIO 1 DATA23/LVDS TX5_p	Depend on JP1
GPIO_1[24]	PIN_L11	inout	GPIO 1 DATA24/LVDS_RX5_n	Depend on JP1
GPIO_1[25]	PIN_A13	inout	GPIO 1 DATA25/LVDS TX5_n	Depend on JP1
GPIO_1[26]	PIN_A17	inout	GPIO 1 DATA26	Depend on JP1
GPIO_1[27]	PIN_A16	inout	GPIO 1 DATA27	Depend on JP1
GPIO_1[28]	PIN_E13	inout	GPIO 1 DATA28/LVDS RX6_p	Depend on JP1
GPIO_1[29]	PIN_C13	inout	GPIO 1 DATA29/LVDS TX6_p	Depend on JP1
GPIO_1[30]	PIN_D13	inout	GPIO 1 DATA30/LVDS RX6_n	Depend on JP1
GPIO_1[31]	PIN_C12	inout	GPIO 1 DATA31/LVDS TX6_n	Depend on JP1
GPIO_1[32]	PIN_G12	inout	GPIO 1 DATA32/LVDS RX7_p	Depend on JP1
GPIO_1[33]	PIN_H7	inout	GPIO 1 DATA33/LVDS TX7_p	Depend on JP1
GPIO_1[34]	PIN_F12	inout	GPIO 1 DATA34/LVDS RX7_n	Depend on JP1
GPIO_1[35]	PIN_J7	inout	GPIO 1 DATA35/LVDS TX7_n	Depend on JP1

C5P System Builder

This chapter describes how users can create a custom design project on the board by using the C5P System Builder. Besides, users can also use the Quartus Golden top for the project building. Golden top project is located in folder: CD\Demonstration.

4.1 Introduction

The C5P System Builder is a Windows-based software utility, designed to assist users to create a Quartus Prime project for the board within minutes. The generated Quartus Prime project files include:

- Quartus Prime project file (.qpf)
- Quartus Prime setting file (.qsf)
- Top-level design file (.v or .vhd)
- Synopsis design constraints file (.sdc)
- Pin assignment document (.htm)

By providing the above files, the C5P System Builder prevents occurrence of situations that are prone to errors when users manually edit the top-level design file or place pin assignments. The common mistakes that users encounter are the following:

- C5P board damage due to wrong pin/bank voltage assignments.
- C5P board malfunction caused by wrong device connections or missing pin counts for connected ends.
- Performance degradation due to improper pin assignments.

4.2 General Design Flow

This section will introduce the general design flow to build a project for the development board via the C5P System Builder. The general design flow is illustrated in **Figure 4-1**.

Users should launch the C5P System Builder and create a new project according to their design requirements. When users complete the settings, the C5P System Builder will generate two major files, a top-level design file (.v or .vhd) and a Quartus Prime setting file (.qsf).

The top-level design file contains top-level Verilog or VHDL HDL wrapper for users to add

their own design/logic. The Quartus Prime setting file contains information such as FPGA device type, top-level pin assignments, and the I/O standard for each user-defined I/O pin.

Finally, the Quartus Prime programmer must be used to download .sof file to the C5P development board using a JTAG interface.

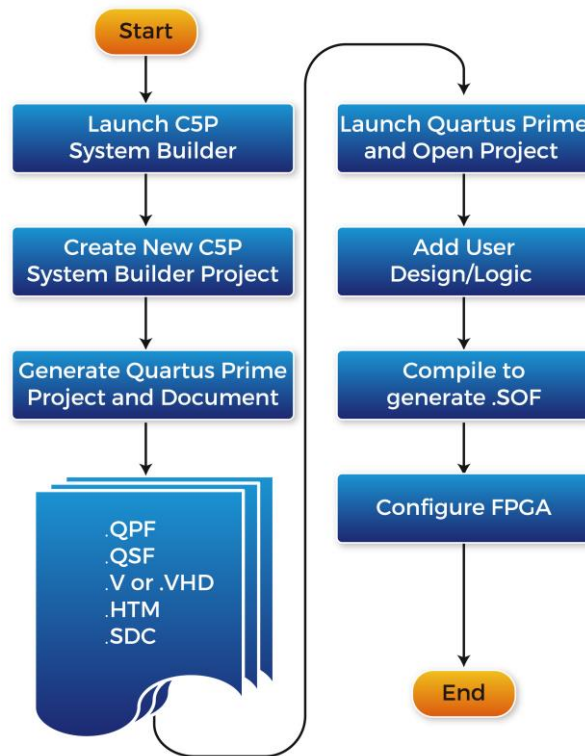

Figure 4-1 The general design flow of building a design

4.3 Using C5P System Builder

This section provides detailed procedures on how to use the C5P System Builder.

■ Install and launch C5P System Builder

The C5P System Builder is located in the directory: “Tools\SystemBuilder” in the C5P System CD. Users can copy the whole folder to a host computer without installing the utility. Launch the C5P System Builder by executing the C5P_SystemBuilder.exe on the host computer and the GUI window will appear as shown in **Figure 4-2**.

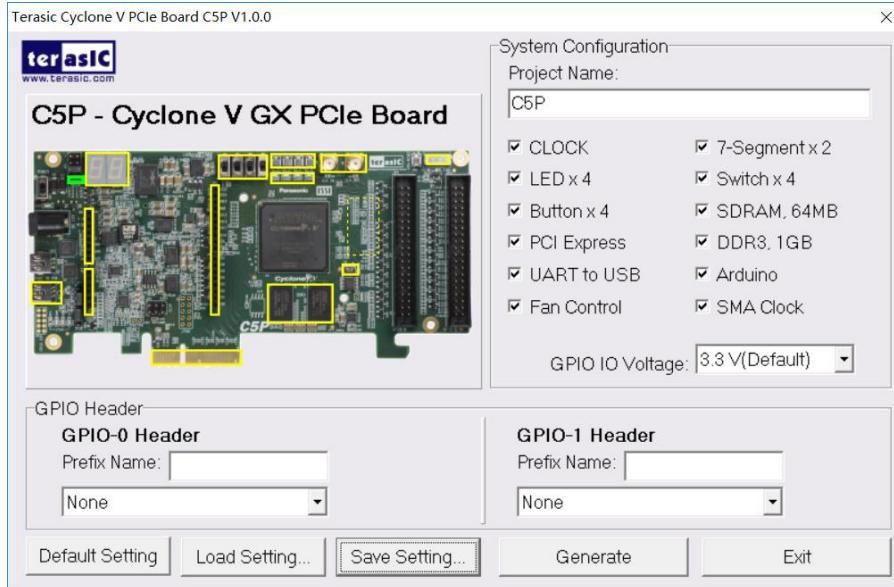

Figure 4-2 C5P System Builder window

■ Input Project Name

Input project name as shown in **Figure 4-3**, type in an appropriate name in the green circled area, it will automatically be assigned as the name of your top-level design entity.

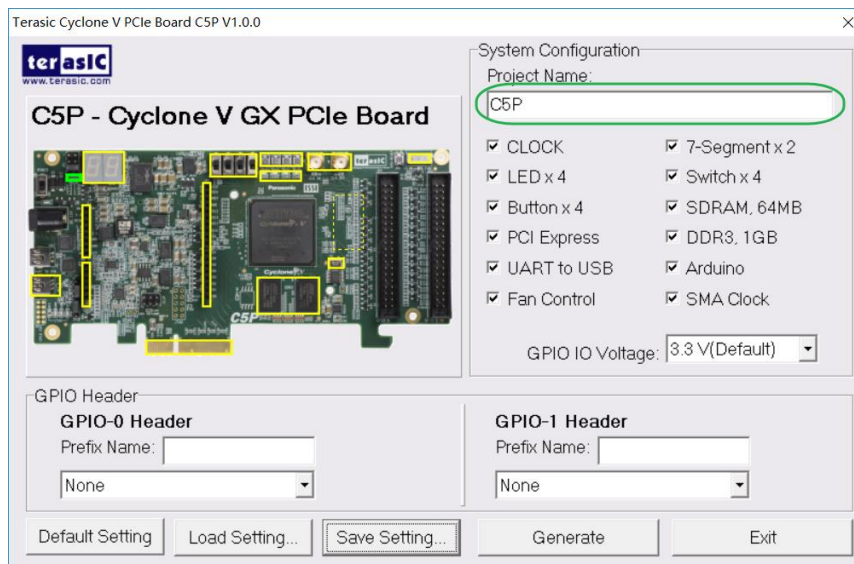

Figure 4-3 Board Type and Project Name

■ System Configuration

Under the System Configuration users are given the flexibility of enabling their choice of components included on the board as shown in **Figure 4-4**, each component of the board is listed where users can enable or disable a component according to their design by

simply marking a check or removing the check in the field provided. If the component is enabled, the C5P System Builder will automatically generate the associated pin assignments including the pin name, pin location, pin direction, and I/O standard.

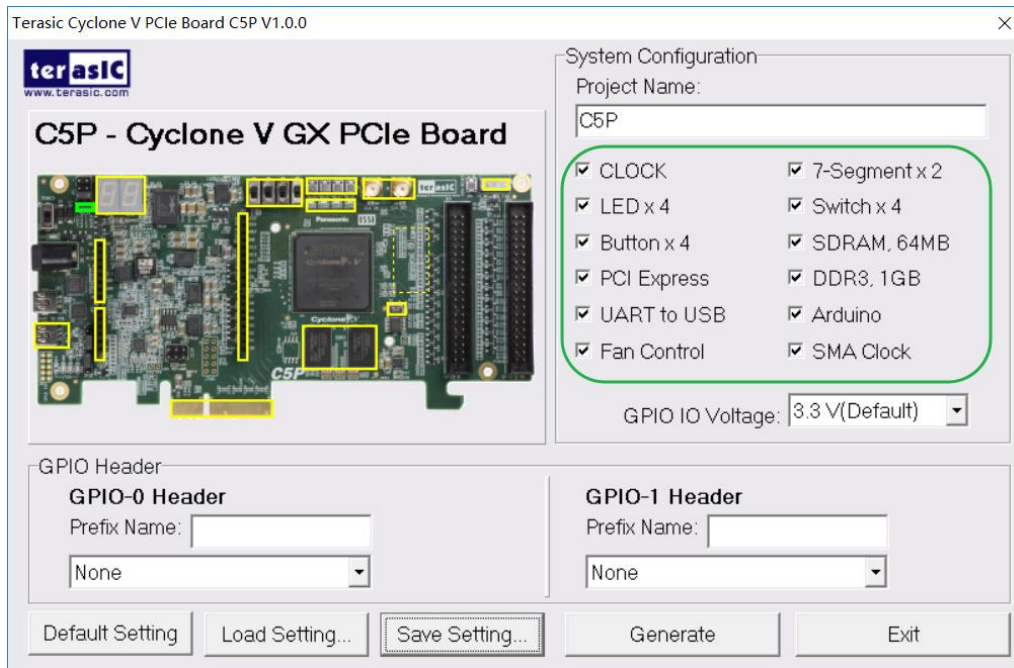

Figure 4-4 System Configuration Group

■ GPIO Expansion

Users can connect Terasic GPIO daughter cards onto the GPIO connector located on the development board. As shown in **Figure 4-5**, the C5P System Builder will generate a project includes related module. It will automatically generate the associated pin assignment including pin name, pin location, pin direction, and I/O standard.

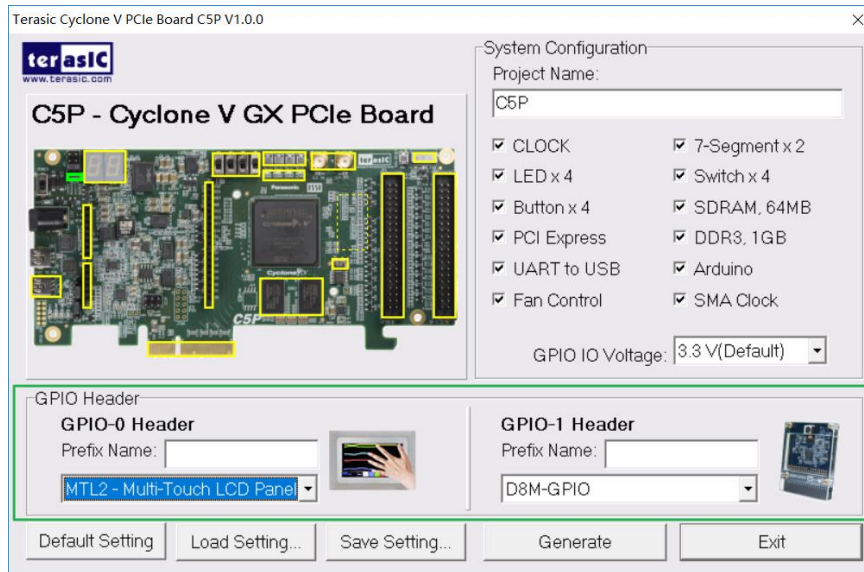

Figure 4-5 GPIO Expansion

The “Prefix Name” is an optional feature that denotes the pin name of the daughter card assigned in your design. Users may leave this field empty.

■ Project Setting Management

The C5P System Builder also provides functions to restore the default setting, loading a setting, and saving users’ board configuration file shown in **Figure 4-6**, Users can save the current board configuration information into a .cfg file and load it to the C5P System Builder.

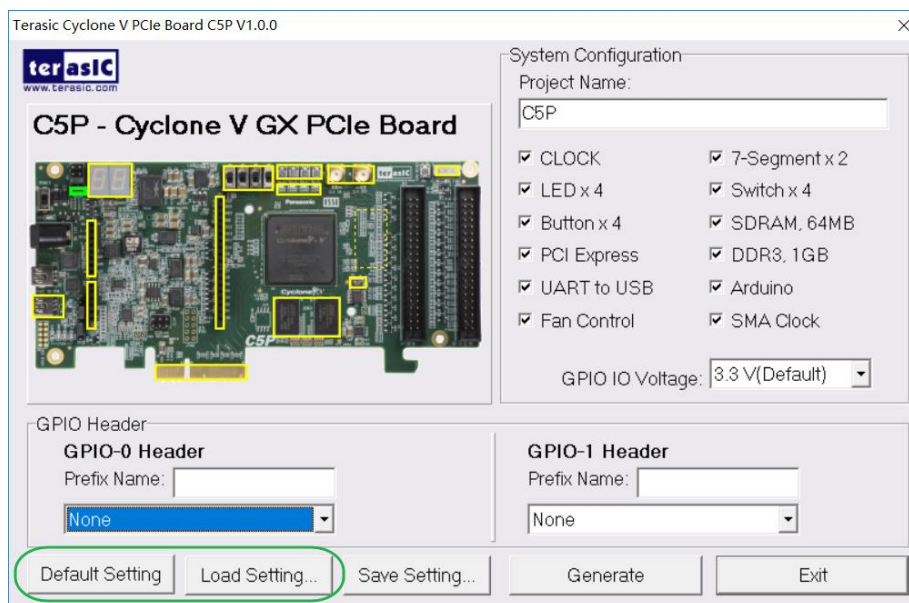

Figure 4-6 Project Management

■ Project Generation

When users press the Generate button, the C5P System Builder will generate the corresponding Quartus Prime files and documents as listed in **Table 4-1**.

Table 4-1 The file generated by C5P System Builder

No.	File Name	Description
1	<Project name>.v	Top Verilog Quartus Prime File
2	<Project name>.qpf	Quartus Prime Project File
3	<Project name>.qsf	Quartus Prime Setting File
4	<Project name>.sdc	Quartus Prime Synopsis Design Constraints File
5	<Project name>.htm	Pin Assignment Document

Users can use Quartus Prime software to add custom logic into the project and compile the project to generate the SRAM Object File (.sof).

Examples of Advanced Demonstrations

This chapter introduces several advanced demos designed by using RTL or Qsys. These examples provide demonstrations of the major features which are connected to the FPGA interface on the board, such as audio, SDRAM and IR Receiver. All these associated files can be found in the Demonstrations folder on the C5P System CD.

■ Demonstration Installation

How to run the Demonstrations with the computer:

Copy the Demonstration folder to the selected local directory, make sure that the path to the local directory does not contain the whitespace, otherwise the Nios II will run the error. Note that you must install the v17.1 or later Quartus Prime to run the C5P development board design example to support the Cyclone V series.

5.1 C5P Factory Default Configuration

The C5P board is shipped from the factory with a default configuration bit-stream that demonstrates some of the basic features of the board, such as LED light water, HEX goes from 0 to F. The setup required for this demonstration, and the locations of its files are explained below.

■ Demonstration Setup and Instructions

- Project directory: C5P_Default.
- Demo Batch File: \C5P_Default\demo_batch_jic\test.bat.
- FPGA Configure File: C5P_Default.sof or C5P_Default.jic.
- Connect the USB cable provided to the USB Blaster II port on the C5P board. Ensure that power is applied to the C5P board. If necessary (EPCQ is erased), please program the default code into EPCQ via the JTAG connection for the factory default configuration.
- Now, the 7-segment displays are enabled to display from 0 to 8, and the LED is flashing.
- To easy running, the project also provides the demo_batch folder. By running the test.bat, it is not only able to download the .sof into FPGA by command, but also enables it to convert .sof to .jic file, which can be used to program the EPCQ

device.

- The result of running the demo is as shown in **Figure 5-1**.
- If users want to reprogram the EPCQ device, the easiest method is to copy the .sof to demo_batch_jic folder, and change the name as C5P_Default. Or open the .bat file by **Text Editor**, modify the name to the new .sof file, execute the test.bat. First select “2” to convert .sof file to .jic file, then select the option “3” to program the .jic into EPCQ device.

```
*****  
Please choose your operation  
"1" for programming .sof to FPGA.  
"2" for converting .sof to .jic  
"3" for programming .jic to EPCQ.  
"4" for erasing .jic from EPCQ.  
*****  
Please enter your choice: [1,2,3,4]?
```

Figure 5-1 The command line for .batch file on FPGA or EPCQ Programming

- It will take 3-4 mins on the .jic file downloading, once the programming operation is finished, reset the board by turning the power switch off and back on; this action causes the new configuration data in the EPCQ256 device to be loaded into the FPGA chip.

5.2 Nios II SDRAM Test

Many applications use a high-performance RAM, such as a SDRAM, to provide temporary storage. In this demonstration the hardware and software designs are provided to illustrate how to perform SDRAM memory access in QSYS. We describe how the Intel FPGA SDRAM Controller IP is used to access the SDRAM, and how the Nios II processor is used to read and write the SDRAM for hardware verification. The SDRAM controller handles the complex aspects of using SDRAM by initializing the memory devices, managing SDRAM banks, and keeping the devices refreshed at appropriate intervals.

■ System Block Diagram

Figure 5-2 shows the system block diagram of this demonstration. The system requires a 50MHz clock provided from the board. The SDRAM Controller is configured as a 64MB controller working at 100MHz frequency. Although the SDRAM hardware also works at 100MHz, it requires a delay to ensure the timing is correct, and the Nios II program is running in the on-chip memory.

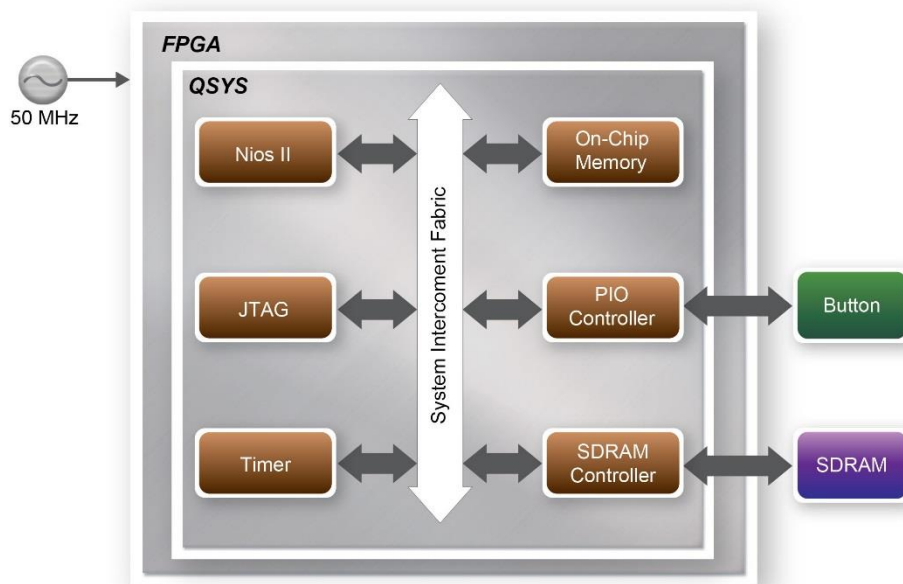

Figure 5-2 Nios II SDRAM Test System Block

The system flow is controlled by a Nios II program. First, the Nios II program writes test patterns into the whole 64MB of SDRAM. Then, it calls Nios II system function, `alt_dcache_flush_all`, to make sure all data has been written to the SDRAM. Finally, it reads data from the SDRAM for data verification. The program will show progress in the JTAG-Terminal when writing/reading data to/from the SDRAM. When the verification process is completed, the result is displayed in the JTAG-Terminal.

■ Design Tools

- Quartus Prime v17.1
- Nios II Eclipse v17.1

■ Demonstration Source Code

- Quartus Project directory: `C5P_SDRAM_Nios_Test`
- Nios II Eclipse directory: `C5P_SDRAM_Nios_Test\Software`

■ Nios II Project Compilation

- Before you attempt to compile the reference design under Nios II Eclipse, make sure the project is cleaned first by clicking 'Clean' from the 'Project' menu of Nios II Eclipse. Refer to the `C5P_My_First_NiosII` document for more details.

■ Demonstration Batch File

Demo Batch File Folder: `\C5P_SDRAM_Nios_Test \demo_batch`.

The demo batch file includes following files:

- USB-Blaster II Batch File: test.bat、 test.sh
- FPGA Configuration File: C5P_SDRAM_Nios_Test.sof
- Nios II Program: C5P_SDRAM_Nios_Test.elf

■ Demonstration Setup

- Make sure Quartus Prime v17.1, Nios II v17.1 and USB-Blaster II driver installed on your PC.
- Use USB cable to connect PC and the C5P (J5) , power on the board.
- Execute the demo batch file “test.bat” for project running under the batch file folder: SDRAM_Nios_Test\demo_batch.
- After Nios II program is downloaded and executed successfully, a prompt message will be displayed in nios2-terminal.
- Press KEY0 or KEY1 of the C5P board to start the SDRAM verify process. Press KEY0 for test continued.
- The program will display progressing and result information, as shown in **Figure 5-3**.

```

Altera Nios II EDS 17.1 [gcc4]
Info (209011): Successfully performed operation(s)
Info (209061): Ended Programmer operation at Tue Mar 13 17:38:01 2018
Info: Quartus Prime Programmer was successful. 0 errors, 0 warnings
Info: Peak virtual memory: 385 megabytes
Info: Processing ended: Tue Mar 13 17:38:01 2018
Info: Elapsed time: 00:00:03
Info: Total CPU time (on all processors): 00:00:02
Using cable "C5P [USB-1]", device 1, instance 0x00
Resetting and pausing target processor: OK
Initializing CPU cache (if present)
OK
Downloaded 72KB in 0.0s
Verified OK
Starting processor at address 0x04020244
nios2-terminal: connected to hardware target using JTAG UART on cable
nios2-terminal: "C5P [USB-1]", device 1, instance 0
nios2-terminal: (Use the IDE stop button or Ctrl-C to terminate)

==== SDRAM Test! Size=64MB (CPU Clock:100000000) ====

=====
Press any KEY to start test [KEY0 for continued test]
====> SDRAM Testing, Iteration: 1
write...
10% 20% 30% 40% 50% 60% 70% 80% 90% 100%
read/verify...
10% 20% 30% 40% 50% 60% 70% 80% 90% 100%
SDRAM test:Pass, 14 seconds
====> SDRAM Testing, Iteration: 2
write...

```

Figure 5-3 Display Progress and Result Information for the Nios II SDRAM Demo

5.3 Verilog SDRAM Test

C5P System CD provides another RTL based example designed for SDRAM test. The memory size of the SDRAM bank is still 64MB.

■ Function Block Diagram

Figure 5-4 shows the function block diagram of this demonstration. The SDRAM controller uses 50MHz as a reference clock, generates one 100MHz as memory clock.

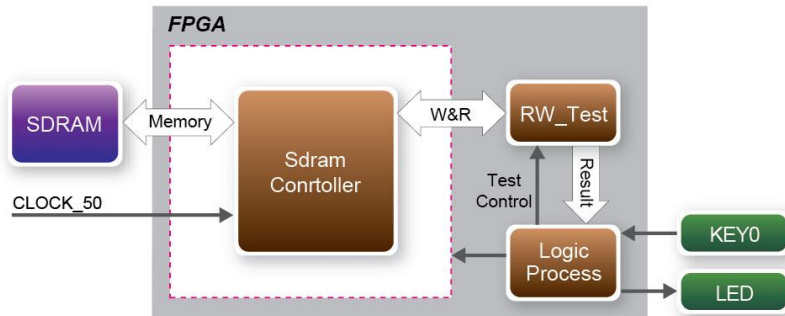

Figure 5-4 Block Diagram of Verilog SDRAM Test

RW_test modules read and write the entire memory space of the SDRAM through the Avalon interface of the controller. In this project, the Avalon bus read/write test module will first write the entire memory and then compare the read back data with the regenerated data (the same sequence as the write data). KEY0 will trigger test control signals for the SDRAM, and the LEDs will indicate the test results according to **Table 5-1**.

■ Design Tools

- Quartus Prime 17.1

■ Demonstration Source Code

- Project directory: C5P_SDRAM_RTL_Test
- Bit stream used: C5P_SDRAM_RTL_Test.sof

■ Demonstration Batch File

Demo Batch File Folder: \C5P_SDRAM_RTL_Test\demo_batch

The demo batch file includes following files:

- Batch File: test.bat
- FPGA Configure File: C5P_SDRAM_RTL_Test.sof

■ Demonstration Setup

- Make sure Quartus Prime 17.1 and USB-Blaster II driver installed on your PC.
- Connect the USB cable to the C5P USB Blaster connector (J5) and the host PC.

- Power on the C5P board.
- Execute the demo batch file “C5P_SDRAM_RTL_Test.bat” under the batch file folder, \C5P_SDRAM_RTL_Test\demo_batch.
- Press KEY0 on the C5P board to start the verification process. When KEY0 is pressed, the LEDs (LEDG [2:0]) should turn on. At the instant of releasing KEY0, LEDG1 & LEDG2 should start blinking.
- After approximately 8 seconds, LED1 should stop blinking and stay on to indicate that the SDRAM test PASS, **Table 5-1** lists the LED indicators.
- If LEDG2 is not blinking, it means 50MHz clock source is not working.
- If LEDG1 fails to remain on after 8 seconds, the corresponding SDRAM test has failed.
- Press KEY0 again to regenerate the test control signals for a new test.

Table 5-1 LED Indicators

Name	Description
LED0	Reset
LED1	If light after KEY0 releasing, SDRAM test pass
LED2	Blinks

5.4 DDR3 SDRAM Test

This demonstration presents a memory test function on the bank of DDR3 SDRAM on the C5P board. The memory size of the DDR3 SDRAM bank is 1GB. Cyclone V device supports both hard memory controller and software memory controller. In this demo, the hard memory controller is used.

■ Function Block Diagram

Figure 5-5 shows the function block diagram of this demonstration. The DDR3 controller uses 50MHz as a reference clock, generates one 400MHz clock as memory clock, and generates one full-rate system clock 200MHz for the controller itself, so the data rate for DDR3 is 800Mbps.

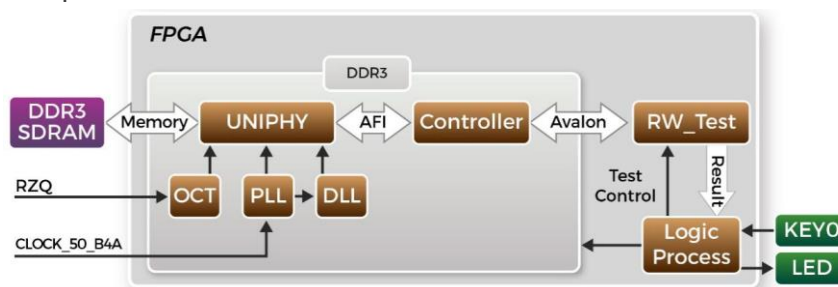

Figure 5-5 Block Diagram of DDR3 Demonstration

RW_test modules read and write the entire memory space of the DDR3 through the Avalon interface of the controller. In this project, the Avalon bus read/write test module will first write the entire memory and then compare the read back data with the regenerated data (the same sequence as the write data). KEY0 will trigger test control signals for the DDR3, and the LEDs will indicate the test results according to **Table 5-2**.

Table 5-2 LED indicator

LED Name	Description
LED0	Reset
LED1	If light, DDR3 test pass
LED2	Blinks

■ DDR3 SDRAM Controller with UniPHY

To use DDR3 controller, users need to perform the three major steps:

- Create correct pin assignments for the DDR3.
- Perform “Analysis and Synthesis” by selecting from the Quartus Prime menu Processing→Start→Start Analysis & Synthesis.
- Run the TCL files generated by DDR3 IP by selecting from the Quartus Prime menu Tools→TCL Scripts.

■ Design Tools

- Quartus Prime v17.1

■ Demonstration Source Code

- Project directory: C5P_DDR3_RTL_Test
- Bitstream File: C5P_DDR3_RTL_Test.sof

■ Demonstration Batch File

Demo Batch File Folder: C5P_DDR3_RTL_Test \demo_batch

The demo batch file includes following files:

- Batch File: test.bat
- FPGA Configure File: C5P_DDR3_RTL_Test.sof

■ Demonstration Setup

- Make sure Quartus Prime v17.1 & USB-Blaster II driver is installed on your PC.
- Connect the USB cable to the USB Blaster II connector (J5) on the C5P board and host PC.

- Power on the C5P board.
- Execute the demo batch file “test.bat” under the batch file folder: C5P_DDR3_RTL_Test\demo_batch.
- Press KEY0 on the C5P board to start the verification process. When KEY0 is pressed, the LEDs (LEDG [2:0]) should turn on. At the instant of releasing KEY0, LEDG1, LEDG2 should start blinking. After approximately 1 seconds, LEDG1 should stop blinking and stay on to indicate that the DDR3 has passed the test, respectively, **Table 5-2** lists the LED indicators.
- If LEDG2 is not blinking, it means 50MHz clock source is not working.
- If LEDG1 does not start blinking after releasing KEY0, it indicates local_init_done or local_cal_success of the corresponding DDR3 failed.
- If LEDG1 fails to remain on after 1 seconds, the corresponding DDR3 test has failed.
- Press KEY0 again to regenerate the test control signals for a new test.

5.5 DDR3 SDRAM Test by Nios II

Many applications use a high-performance RAM, such as a DDR3 SDRAM Controller with UniPHY IP, to provide temporary storage. In this demonstration hardware and software designs are provided to illustrate how to perform DDR3 memory access in QSYS. We describe how the Altera’s “DDR3 SDRAM Controller with UniPHY IP” is used to access the DDR3-SDRAM, and how the Nios II processor is used to read and write the SDRAM for hardware verification. The DDR3 SDRAM controller handles the complex aspects of using DDR3 SDRAM by initializing the memory devices, managing SDRAM banks, and keeping the devices refreshed at appropriate intervals. Cyclone V series device supports both hard memory IP and soft memory IP. In this demonstration, it uses the hard memory IP.

■ System Block Diagram

Figure 5-6 shows the system block diagram of this demonstration. The system requires a 50MHz clock provided from the board. The DDR3 controller is configured as a 1GB DDR3-400 controller with the DDR3 data rate of 800Mbps. DDR3 IP generates one 400MHz clock as DDR3’s data clock and one half-rate system clock 200MHz for those host controllers. In the QSYS, Nios II and the On-Chip Memory are designed running with the 100MHz clock, and the Nios II program is running in the on-chip memory.

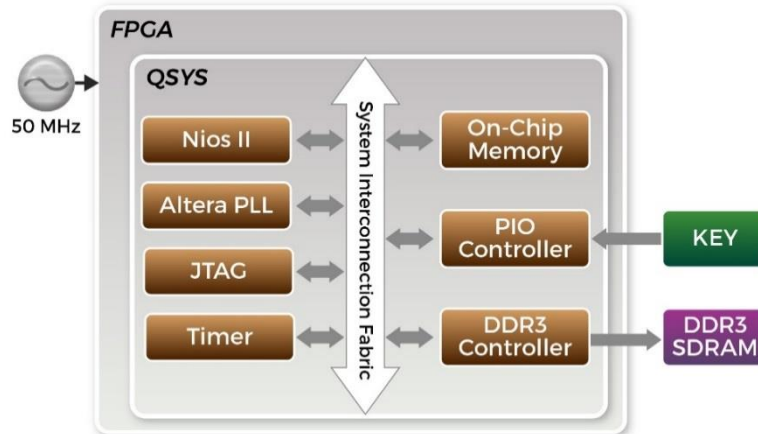

Figure 5-6 Block diagram of the DDR3 Demonstration

The system flow is controlled by a Nios II program. First, the Nios II program writes test patterns into the whole 1GB of DDR3. Then, it reads data from the DDR3 for data verification. The program will show progress in JTAG-Terminal when writing/reading data to/from the DDR3. When the verification process is completed, the result is displayed in the JTAG-Terminal.

■ DDR3 SDRAM Controller with UniPHY

To use the DDR3 SDRAM controller, users need to perform the three major steps:

- Create correct pin assignments for the DDR3.
- Perform “Analysis and Synthesis” by selecting from the Quartus Prime menu: Processing→Start→Start Analysis & Synthesis.
- Run the TCL files generated by the DDR3 IP by selecting from the Quartus II menu:
Tools→TCL Scripts.

■ Design Tools

- Quartus Prime v17.1
- Nios II Eclipse v17.1

■ Demonstration Source Code

- Quartus Project directory: C5P_DDR3_Nios_Test
- Nios II Eclipse: C5P_DDR3_Nios_Test\software

■ Nios II Project Compilation

Before you attempt to compile the reference design under Nios II Eclipse, make sure the

project is cleaned first by clicking “Clean” from the “Project” menu of Nios II Eclipse.

■ Demonstration Batch File

Demo Batch File Folder: C5P_DDR3_Nios_Test\demo_batch

The demo batch file includes following files:

- Batch File for USB Blaster II: test.bat, test.sh
- FPGA Configure File: C5P_DDR3_Nios_Test.sof
- Nios II Program: MEM_TEST.elf

■ Demonstration Setup

- Make sure Quartus Prime v17.1, Nios II and USB-Blaster II driver are all installed on your PC.
- Use USB cable to connect PC and the C5P board USB Blaster II connector (J5).
- Power on the C5P board.
- Execute the demo batch file “test.bat” under the batch file folder:
C5P_DDR3_Nios_Test\demo_batch.
- After Nios II program is downloaded and executed successfully, a prompt message will be displayed in nios2-terminal.
- Press KEY3~KEY0 of the C5P board to start DDR3 verify process. Press KEY0 for continued test. Press any other KEY to terminate the test.

- The program will display progressing and result information, as shown in **Figure 5-7**.

```

C:\> Altera Nios II EDS 17.1 [gcc4]
Info (209061): Ended Programmer operation at Tue Mar 13 10:49:21 2018
Info: Quartus Prime Programmer was successful. 0 errors, 0 warnings
Info: Peak virtual memory: 383 megabytes
Info: Processing ended: Tue Mar 13 10:49:21 2018
Info: Elapsed time: 00:00:11
Info: Total CPU time (on all processors): 00:00:03
Using cable "C5P [USB-1]", device 1, instance 0x00
Resetting and pausing target processor: OK
Initializing CPU cache (if present)
OK
Downloaded 72KB in 0.1s
Verified OK
Starting processor at address 0x41040244
nios2-terminal: connected to hardware target using JTAG UART on cable
nios2-terminal: "C5P [USB-1]", device 1, instance 0
nios2-terminal: (Use the IDE stop button or Ctrl-C to terminate)

==== DDR3 Test! Size=1024MB (CPU Clock:100000000) ====

=====
Press any KEY to start test [KEY0 for continued test]
=====> DDR3 Testing, Iteration: 1
write...
10% 20% 30% 40% 50% 60% 70% 80% 90% 100%
read/verify...
10% 20% 30% 40% 50% 60% 70% 80% 90% 100%
DDR3 test:Pass, 137 seconds
=====> DDR3 Testing, Iteration: 2
write...
10% 20% 30% 40% 50% 60% 70%

```

Figure 5-7 Display Progress and Result Information for the DDR3 Demonstration

5.6 UART Control

Many applications need communication with computer through common ports, the traditional connector is RS232 which needs to connect to a RS232 cable. But today many personal computers don't have the RS232 connector which makes it very inconvenient to develop projects. The C5P board is designed to support UART communication through the USB cable. The UART to USB circuit is responsible for converting the data format. Developers can use a USB cable rather than a RS232 cable to enable the communication between the FPGA and the host computer. In this demonstration we will show you how to control the LEDs by sending a command on the computer putty terminal. The command is sent and received through a USB cable to the FPGA. Note that in FPGA, the information was received and sent through a UART IP.

■ Block Diagram

Figure 5-8 shows the hardware block diagram of this demonstration. The system requires a 50MHz clock provided from the board. The PLL generates a 100MHz clock for Nios II processor and the controller IP. The LEDs are controlled by the PIO IP. The UART controller sends and receives command data and the command is sent through the Putty terminal on the computer.

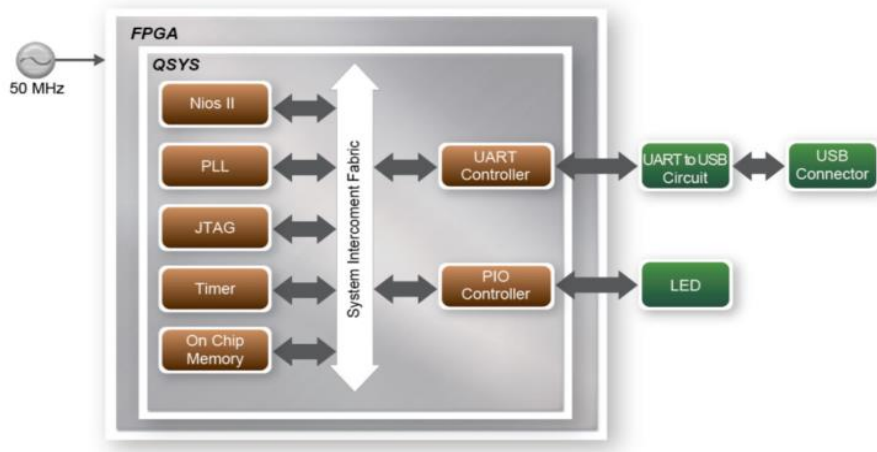

Figure 5-8 Block diagram of UART Control LED demonstration

■ Design Tools

- Quartus Prime v17.1
- Nios II Eclipse v17.1

■ Demonstration Source Code

- Quartus Project Directory: \C5P_UART_USB_LED
- Nios II software Directory: C5P_UART_USB_LED\software

■ Demonstration Batch File

Demo Batch File Folder: \C5P_UART_USB_LED \demo_batch

The demo batch file includes following files:

- Batch File: test.bat、test.sh
- FPGA Configure File: C5P_UART_USB_LED.sof
- Nios II Program: C5P_UART_USB_LED.elf

■ Demonstration Setup

- Connect a USB cable between your computer and the UART TO USB port (J6).

- Power on the C5P board.
- Open PC **Device Manager**, if you find an unrecognized USB Serial Port in Device Manager as shown in **Figure 5-9**, you should install the UART to USB driver before you run the demonstration. The driver CP210x_VCP.exe is located in the C5P System CD directory Tool\serial_driver\, execute it and install.

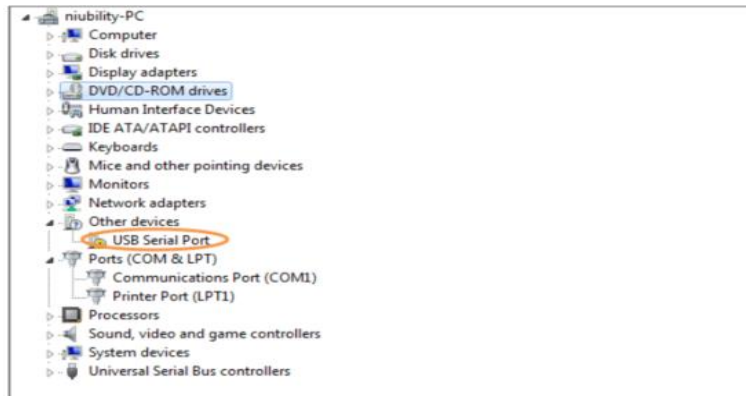

Figure 5-9 Unrecognized USB Serial Port on PC

- Open the Device Manager to ensure which common port is assigned to the UART to USB port as shown in **Figure 5-10**.

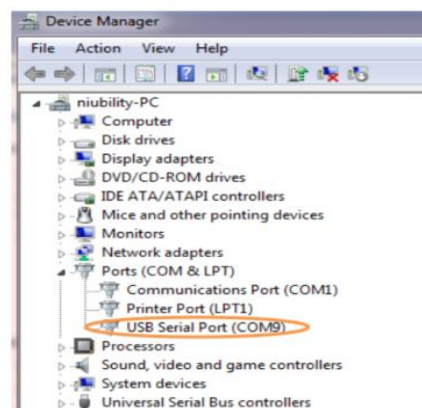

Figure 5-10 Check the assigned Com Port Number On PC

- Open the putty software, type in the parameter as shown in **Figure 5-11**, and click open button to open the terminal. (Here is a link for you to download the putty terminal <http://the.earth.li/~sgtatham/putty/latest/x86/putty.exe>)

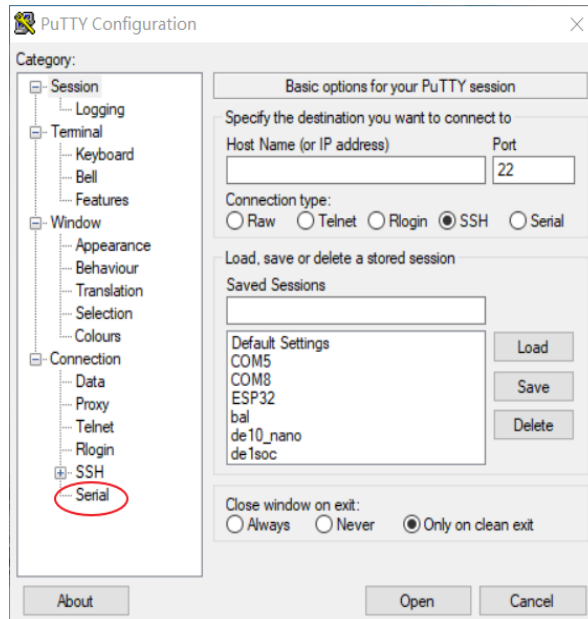

Figure 5-11 Click serial

- Set the PuTTY Configuration, set COM port number as same as shown in Device Manager, baud rate “115200”, Flow Control select “None”, as shown in **Figure 5-12**.

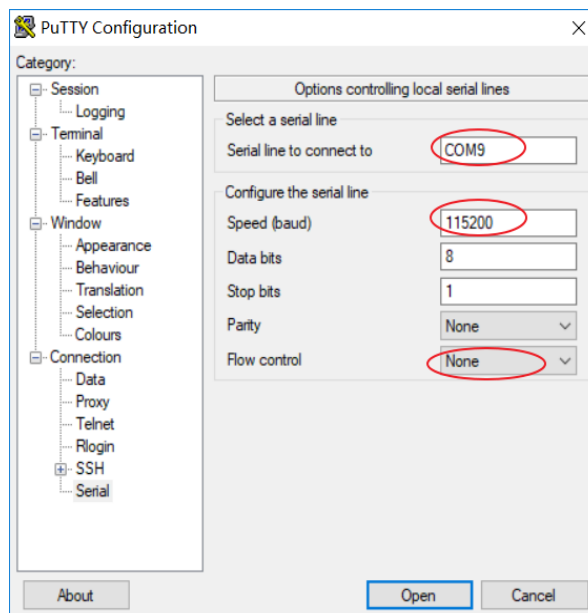

Figure 5-12 Set Port Paramaters

- Click Session, turn back to original window, as shown in **Figure 5-13**. Select the Serial, make sure the COM port number & baud rate set correctly, Click Open.

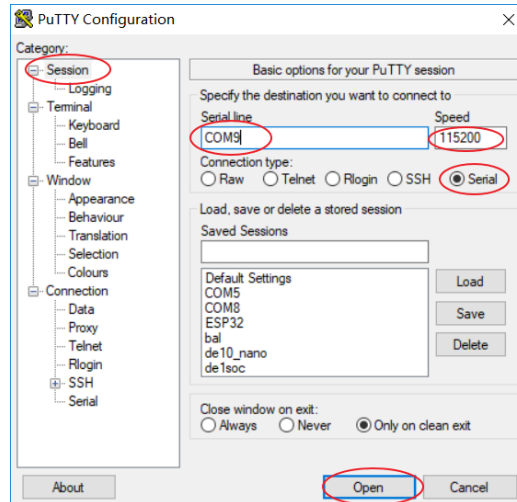

Figure 5-13 Click Open for terminal

- Make sure Quartus Prime and Nios II are installed on your PC.
- Connect USB Blaster II to the C5P board (J5) and install USB Blaster II driver if necessary.
- Execute the demo batch file “test.bat” under demo batch.
- The Nios II-terminal and putty terminal running result as shown in **Figure 5-14**.

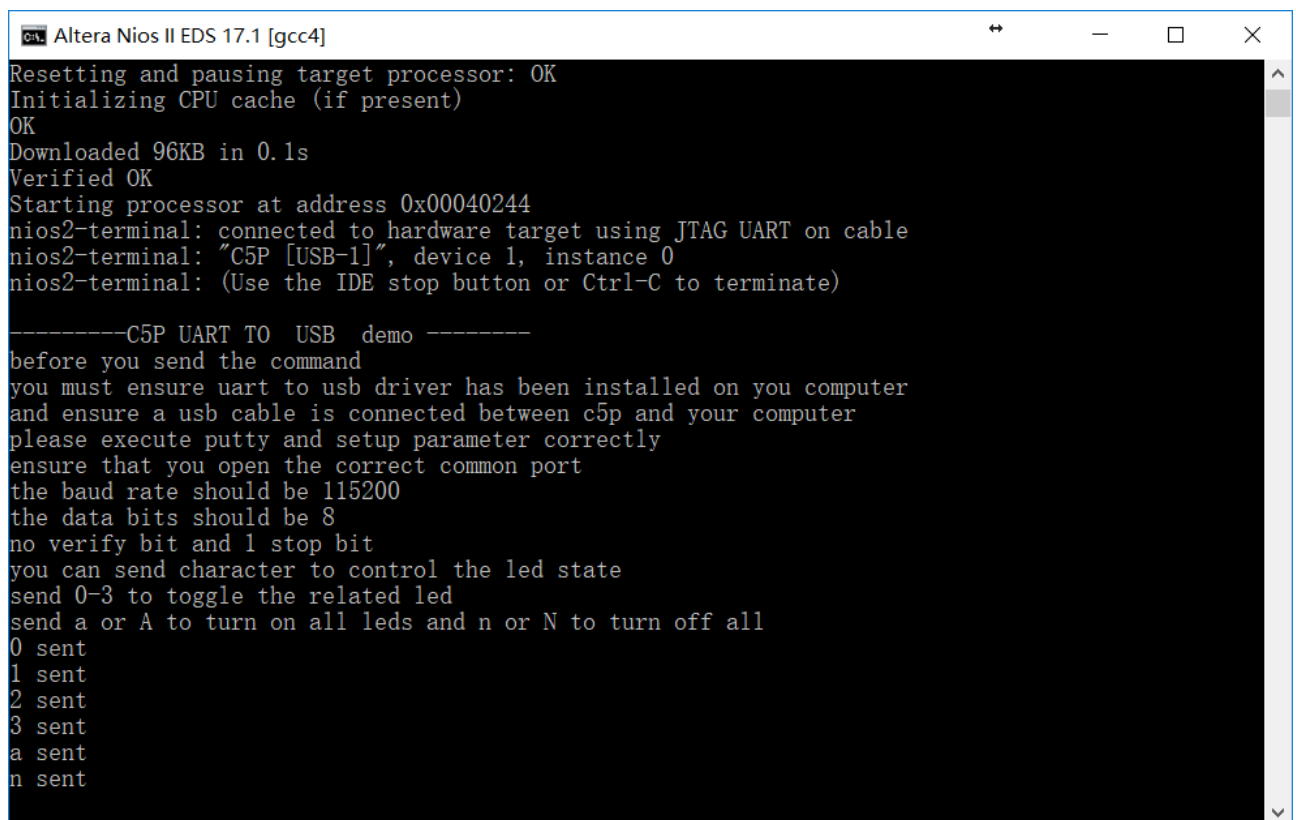

Figure 5-14 Running result of uart_usb demo

- In the putty terminal, type character to change the LED state. (No need to press 'ENTER'). Type a digital number (0~3) to toggle the LEDR[3..0] state and type a/A or n/N to turn on/off all LEDR, the corresponding command will show in the NIOS II terminal.

Note: If the steps to configure the serial port are not correct, it might be the format of the input is incorrect, please follow the steps to reconfigure PUTTY.

5.7 ADC Reading

This demonstration illustrates steps which can be used to evaluate the performance of the 8-channel 12-bit A/D Converter LTC2308. The analog signals are input into the analog input of the Arduino header as shown in **Figure 5-15**, the C5P board can provide 3.3V、5V、12V power to the peripheral connecting to the header JP5. Connect the Trimmer Potentiometer input to the 5V power pin, and output pins to corresponding Analog_In pins, the voltage value with 12 bits accuracy can be obtained by the Nios II controlling the ADC Controller, as shown in **Figure 5-16**.

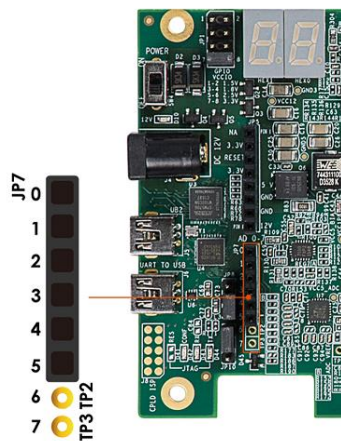

Figure 5-15 ADC I/O

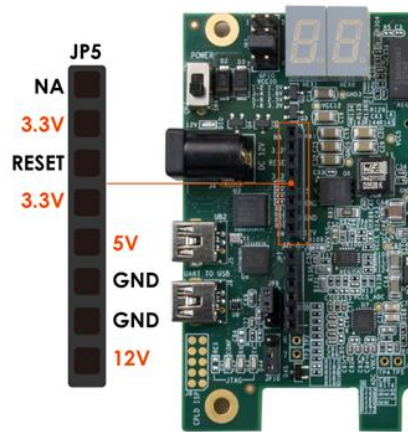

Figure 5-16 Power supply from C5P

Figure 5-17 shows the block diagram of this demonstration. The analog input (Analog_in0 ~ Analog_in7) of the Arduino header is the input source of ADC converter. The default full-scale of ADC is 0~4V while supplying reference voltage range from -2.0V~2.0V on the Arduino header.

Note: Analog_in4 and Analog_in5 is a multiplexer with other IO, Figure 3-20 shows the ADC Pin distribution of the Arduino header. Please select 1-2 of JP8 and JP10 to switch to ADC input.

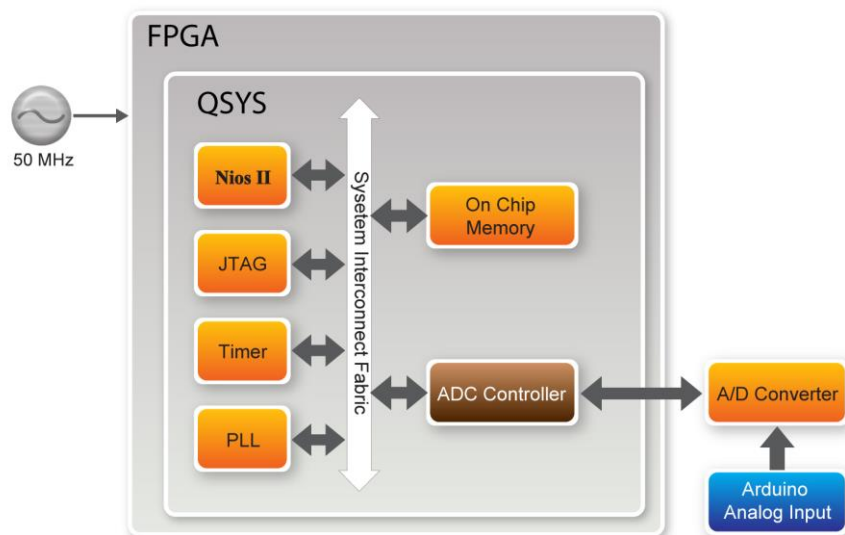

Figure 5-17 ADC System Block Diagram

FPGA will read the associated register in the converter via serial interface and translates it to voltage value displayed on the NIOS II console. The LTC2308 is a low noise, 500ksps,

8-channel, 12-bit ADC with an SPI/MICROWIRE compatible serial interface. The internal conversion clock allows the external serial output data clock (SCK) to operate at any frequency up to 40MHz. In this demonstration, we realized the SPI protocol in Verilog, and packet it into Avalon MM slave IP so that it can be connected to Qsys. **Figure 5-18** is SPI timing specification of LTC2308.

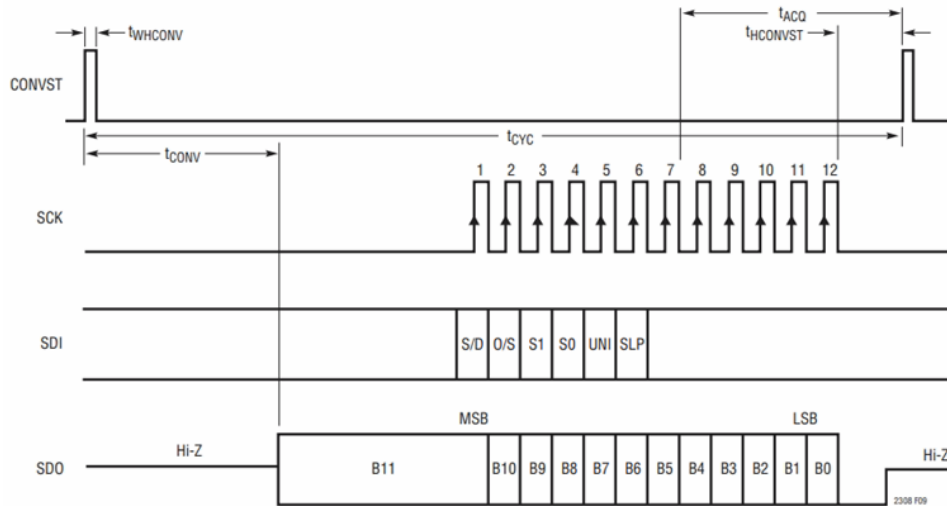

Figure 5-18 LTC2308 Timing with a Short CONVST Pulse

Note: the user should pay great attention to the impedance matching between the input source and the ADC circuit. If the drive circuit has low impedance, the ADC input will be directly driven. Otherwise, high impedance power takes more time on signal collection.

To increase acquisition time t_{ACQ} , user can change the $t_{HCONVST}$ macro value in `adc_ltc2308.v`. When SCK is set to 40MHz, it means 25ns per unit. $t_{HCONVST}$ default set to 320 for 100MHz sample rate. Thus, adding more $t_{HCONVST}$ time (by increasing $t_{HCONVST}$ macro value) will lower the sample rate of the ADC Converter

```
`define tHCONVST    320
```

Figure 5-19 shows the example MUX configurations of ADC. In this demonstration, it is configured as 8 signal-end channels in the verilog code. The default reference voltage is 4.096V by floating Analog_Vref pin on the Arduino header.

The formula of the sample voltage is:

$$\text{Sample Voltage} = \text{ADC Data} / \text{full scale Data} * \text{Reference Voltage.}$$

In this demonstration, full scale is $2^{12} = 4096$. Reference Voltage is 4.096V. Thus

$$\text{ADC Value} = \text{ADC data} / 4096 * 4.096 = \text{ADC data} / 1000$$

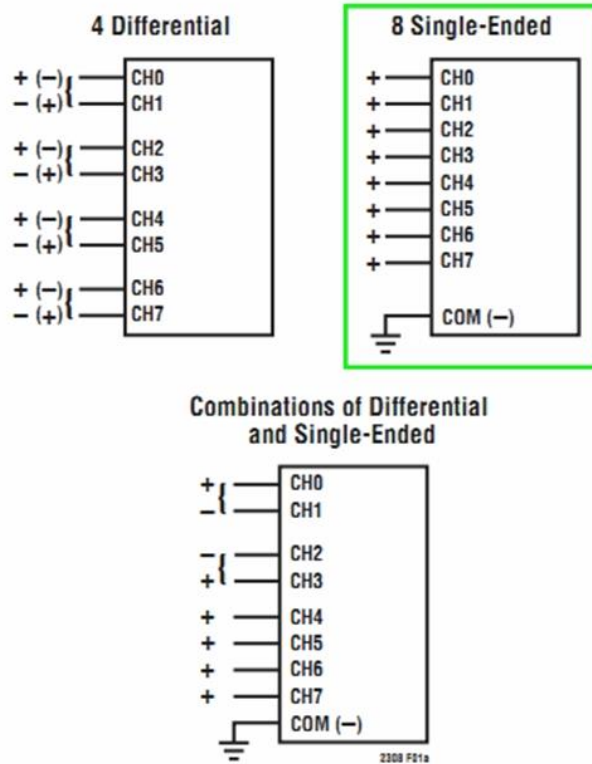

Figure 5-19 Example MUX Configurations

■ System Requirements

The following items are required for the ADC Reading demonstration:

- C5P Board x1
- Trimmer Potentiometer x1
- Wire x3

■ Demonstration File Locations

- Hardware Project directory: C5P_ADC
- Bit stream used: C5P_ADC.sof
- Software Project directory: C5P_ADC software
- Demo batch file: C5P_ADC\demo_batch\C5P_ADC.bat

■ Demonstration Setup and Instructions

- As shown in **Figure 5-20**, connect the Trimmer Potentiometer to corresponding ADC channels on the Arduino IO header. **Please make sure working on the ADC channels (AD4 or AD5) by referring to Table 3-12.** Connect the Trimmer Potentiometer input to JP5 5V(Pin5) & GND(Pin6 or Pin7), and connect the

output to channel 0(JP7 Pin1).

- Execute the demo batch file C5P_ADC.bat to load bit stream and software execution file in the FPGA.
- The Nios II console will display the voltage of the specified channel voltage result information.
- Provide any input voltage to other ADC channels and set SW[2:0] to the corresponding channel if user wants to measure other channels.

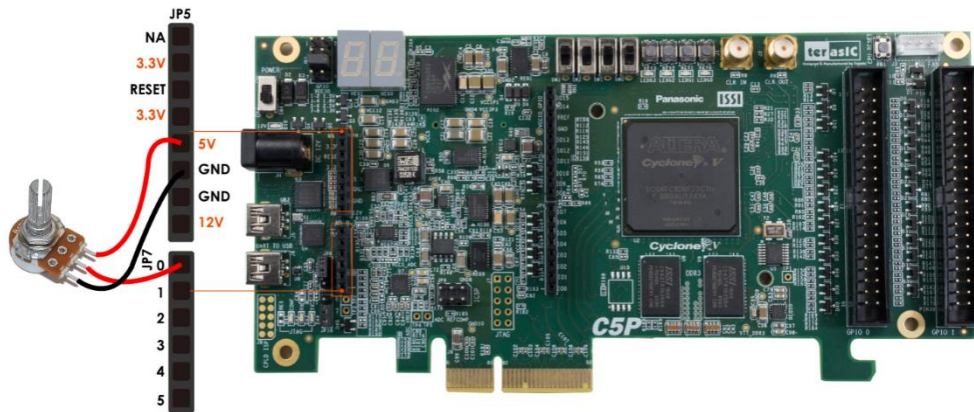

Figure 5-20 ADC Reading Demo hardware setup

Programming the EPCQ

This chapter describes how to program the quad serial configuration (EPCQ) device with Serial Flash Loader (SFL) function via the JTAG interface. Users can program EPCQ devices with a JTAG indirect configuration (.jic) file, which is converted from a user-specified SRAM object file (.sof) in Quartus. The .sof file is generated after the project compilation is successful. The steps of converting .sof to .jic in Quartus are listed below. It is also able to use batch file for the EPCQ programming, refer to [Section 5.1 C5P Factory Default Configuration](#) for the details.

6.1 Convert .sof File to .jic File

1. Choose **Convert Programming Files** from the File menu of Quartus Prime, as shown in **Figure 6-1**.

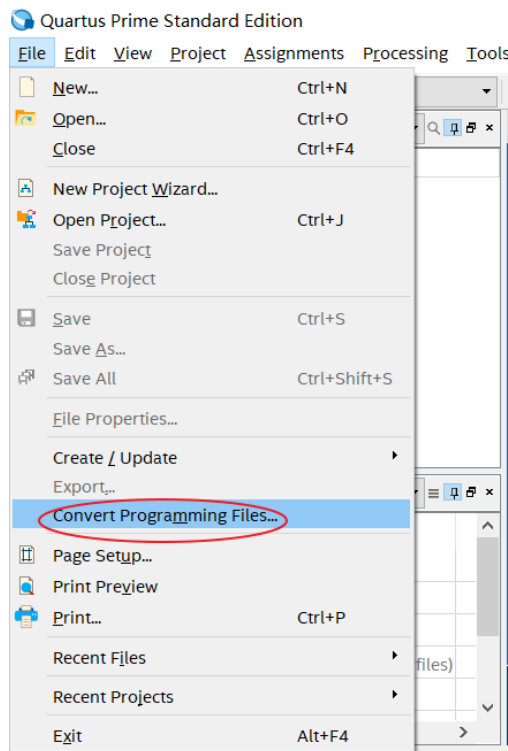

Figure 6-1 Quartus Prime File Menu

2. Select **JTAG Indirect Configuration File (.jic)** from the **Programming file type** field in the dialog of Convert Programming Files.
3. Choose **EPCQ256** from the **Configuration device**.

4. Choose **Active Serial x4** from the **Mode** field.
5. Browse to the target directory from the **File name** field and specify the name of output file.
6. Click on the **SOF data** in the section of **Input files to convert**, as shown in **Figure 6-2**.

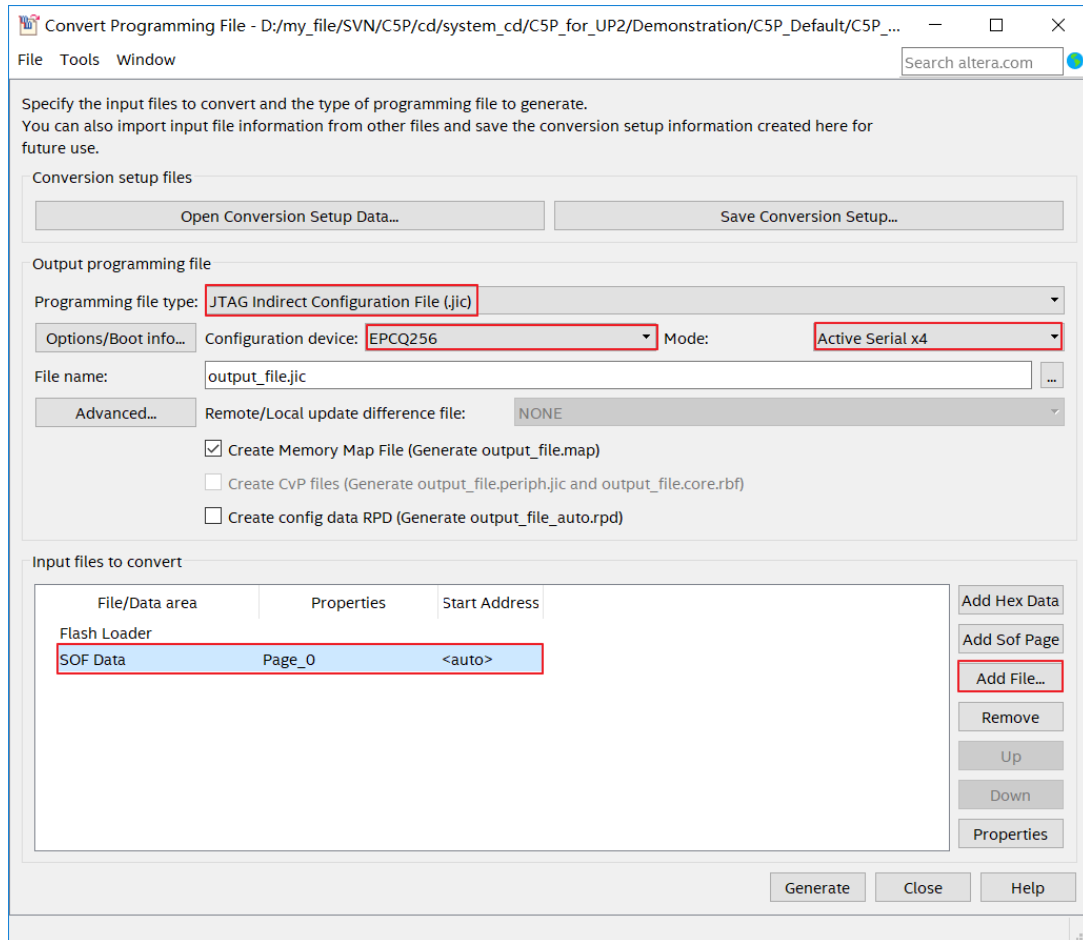

Figure 6-2 Dialog of “Convert Programming File”

7. Click **Add File**.
8. Select the .sof to be converted to a .jic file from the Open File dialog.
9. Click **Open**.
10. Click on the **Flash Loader** and click **Add Device**, as shown in **Figure 6-3**.
11. Click **OK** and the **Select Devices** page will appear.

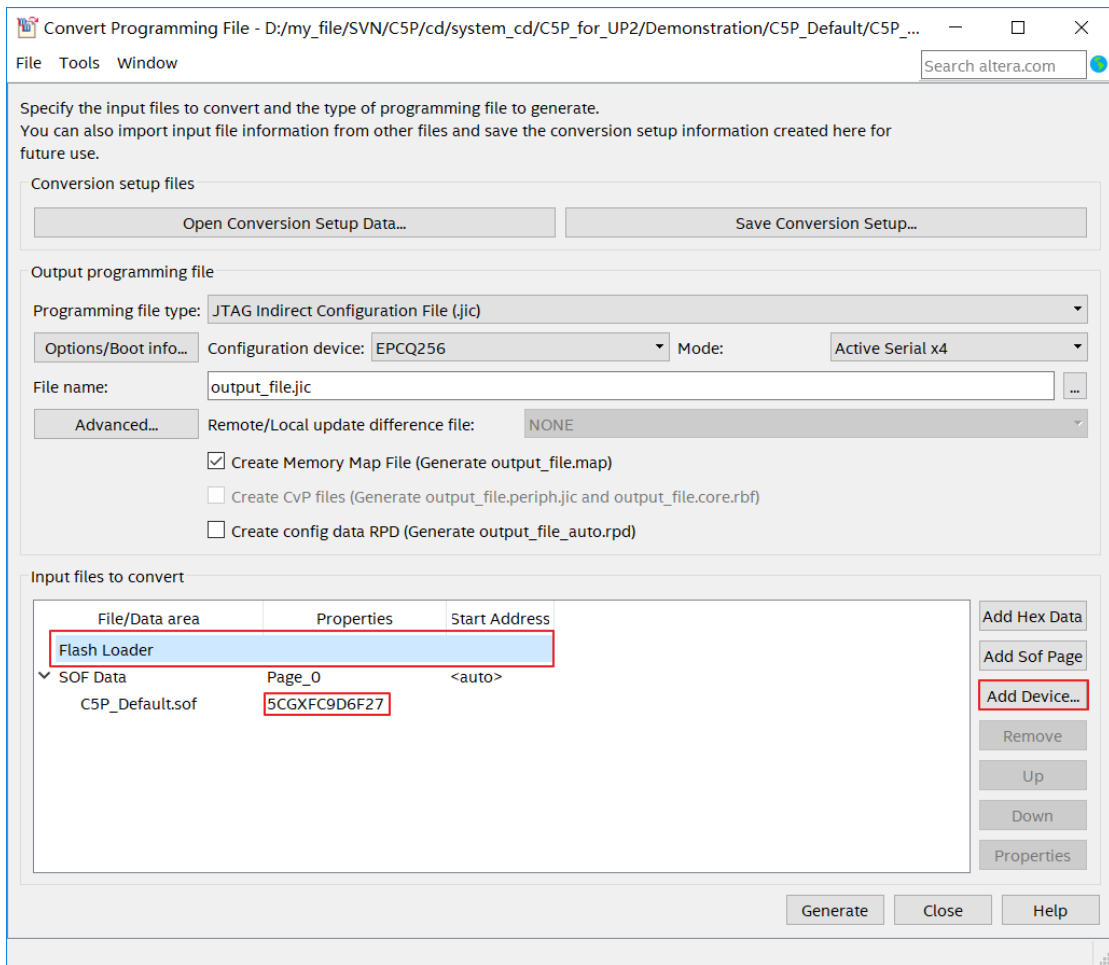

Figure 6-3 Click on the “Flash Loader”

12. As shown in **Figure 6-4**, choose the same FPGA device to with the SOF Data.
13. Click **OK** and the Convert Programming Files will appear, as shown in **Figure 6-5**.
14. Click **Generate**, the .jic file will be generated in the seleted directory.

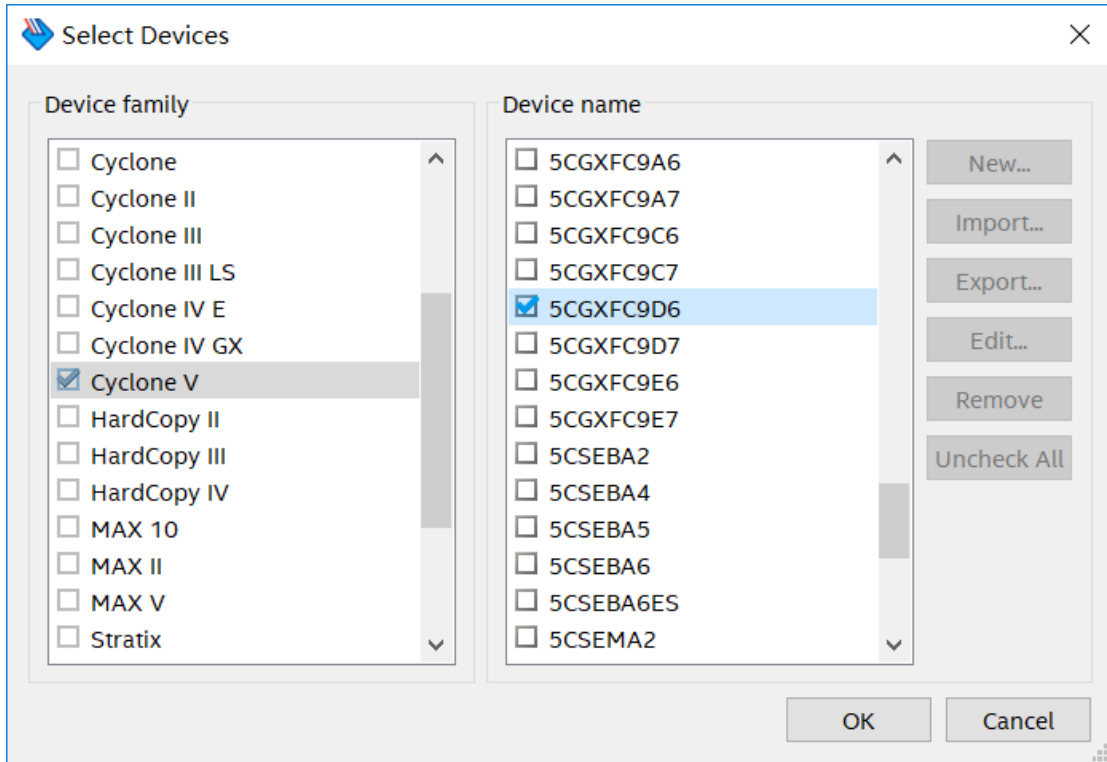

Figure 6-4 Select Devices Page

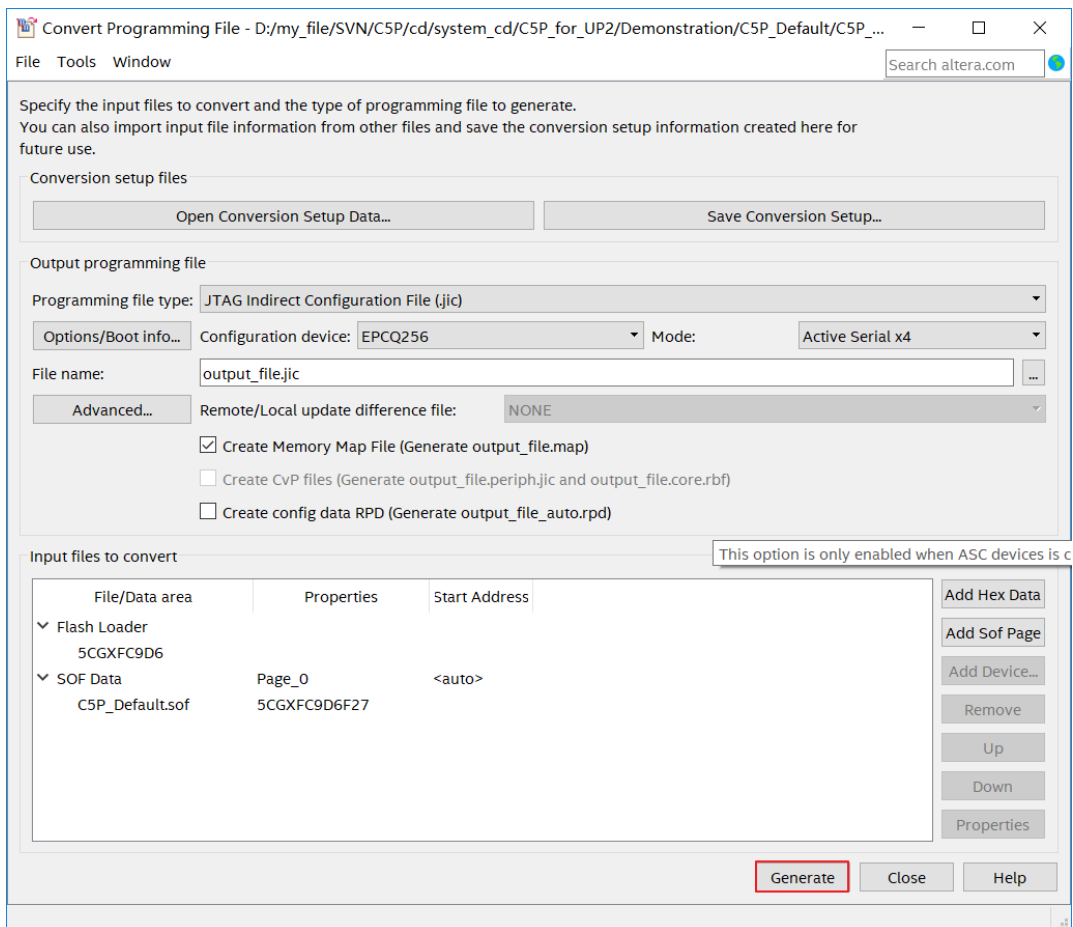

Figure 6-5 Convert Programming Files Page

6.2 Write.jic File to EPCQ

When the conversion of SOF-to-JIC file is complete, please follow the steps below to program the EPCQ device with the .jic file created in Quartus Prime Programmer.

1. In Quartus Prime Tools menu, choose **Programmer** from the Tools menu and the **Chain.cdf** window will appear.
2. Click **Auto Detect** and then select the correct device. The FPGA device should be detected, as shown in **Figure 6-6**.
3. Double click the red rectangle region, as shown in **Figure 6-6** and the **Select New Programming File** page will appear. Select the .jic file to be programmed.
4. Program the EPCQ device by clicking the corresponding **Program/Configure** box. A factory default SFL image will be loaded, as shown in **Figure 6-7**.
5. Click **Start** to program the EPCQ device.

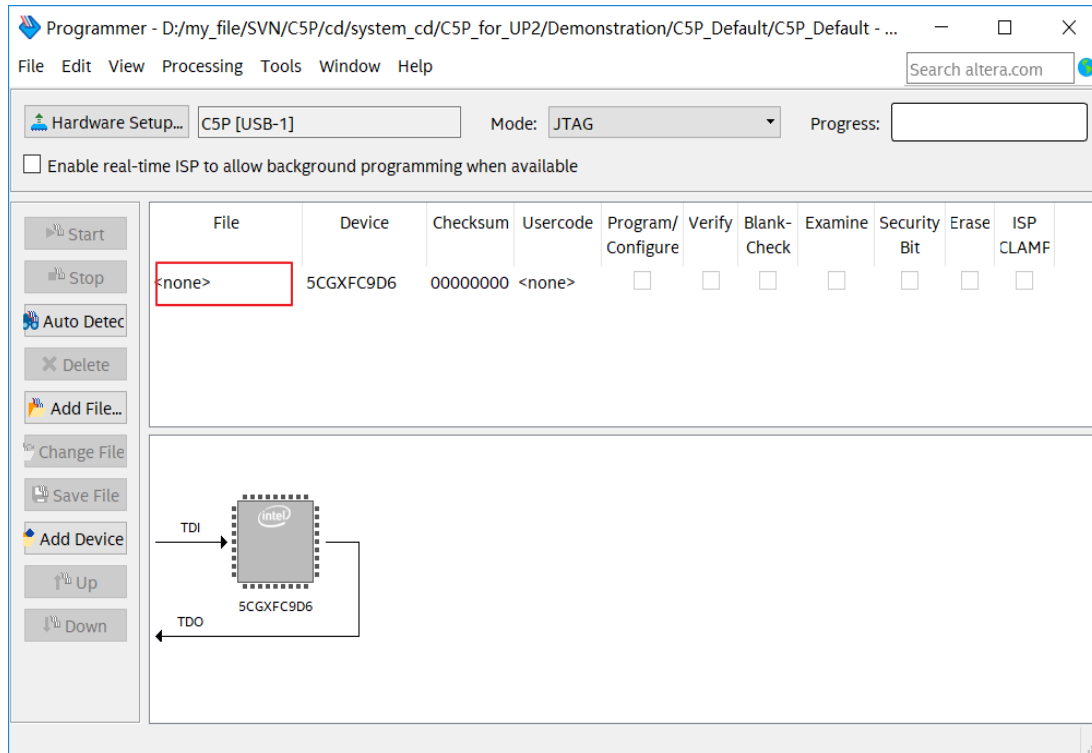

Figure 6-6 Quartus Prime Programmer detecte FPGA device

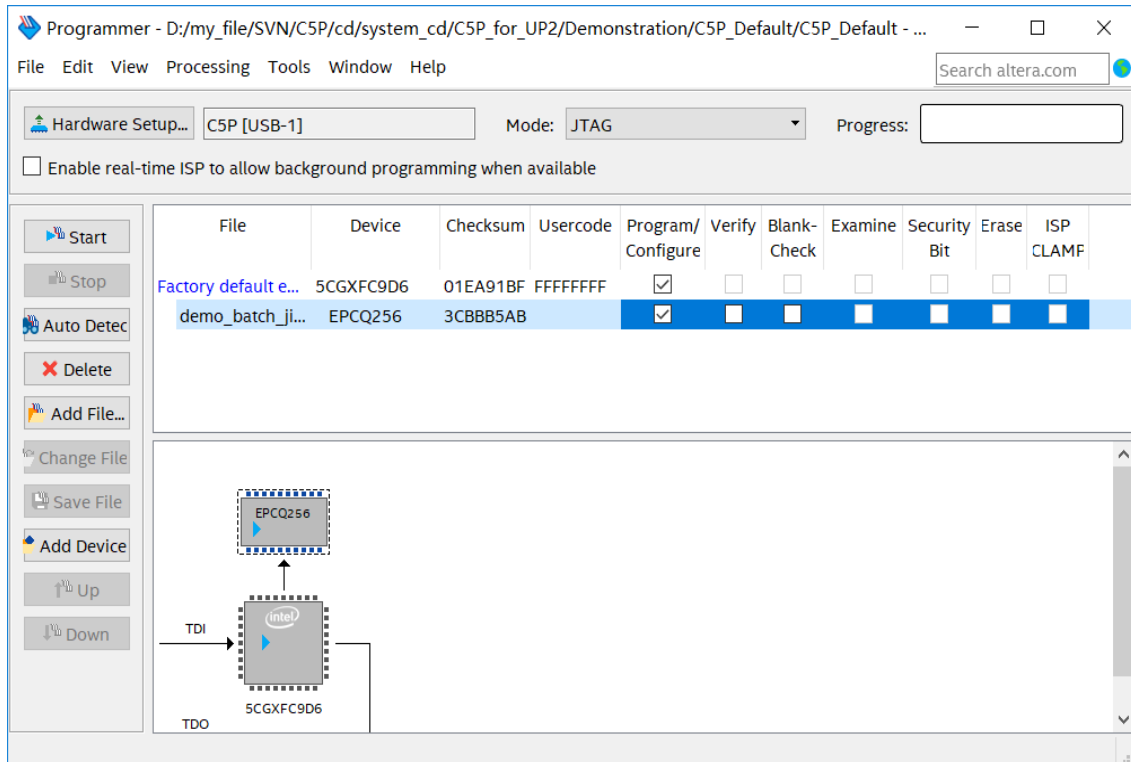

Figure 6-7 Quartus Prime Programmer window with .jic file

6.3 Erase the EPCQ device

The steps to erase the existing file in the EPCQ device are:

1. Choose **Programmer** from the **Tools** menu and the **Chain.cdf** window will appear.
2. Click **Auto Detect**, and then select correct device, FPGA device will be detected, as shown in **Figure 6-6**.
3. Double click the red rectangle region shown in **Figure 6-6**, the **Select New Programming File** page will appear. Select the correct .jic file.
4. Erase the EPCQ device by clicking the corresponding **Erase** box. A factory default SFL image will be loaded, as shown in **Figure 6-8**.

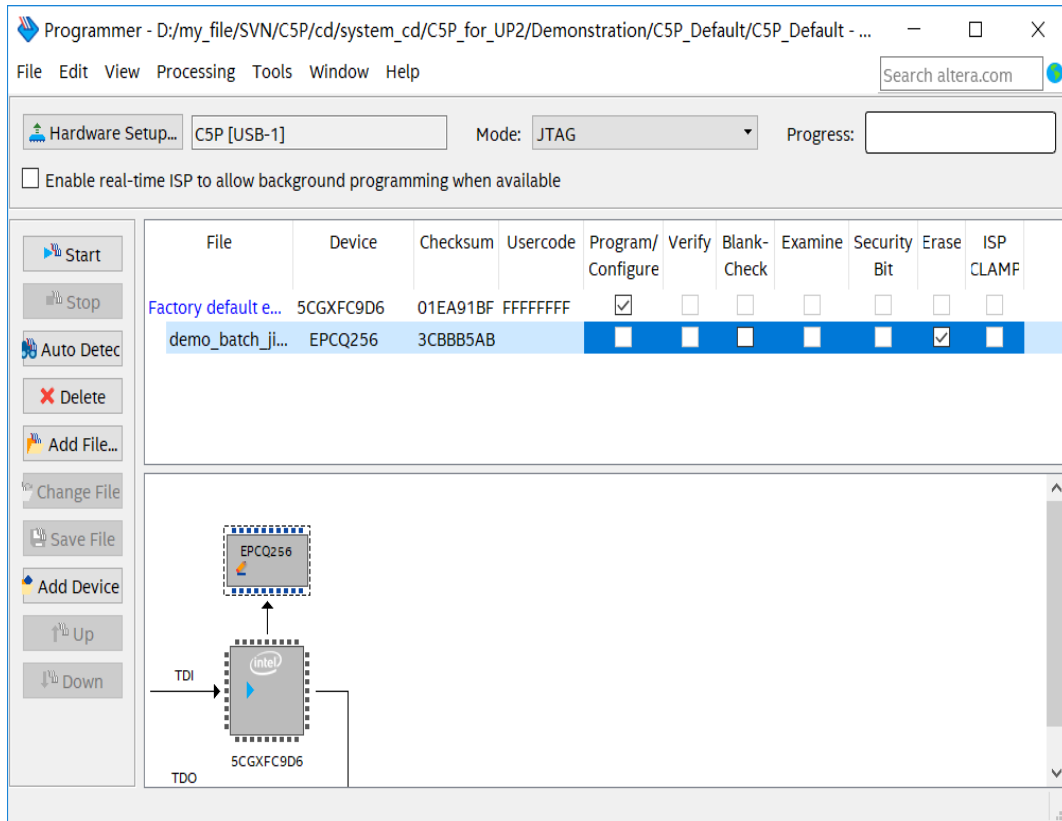

Figure 6-8 Erase the EPCQ device

5. Click **Start** to erase the EPCQ device.

Note: in addition to using the above method to program or erase FLASH, users can also use .batch file to convert the .Jic file for programming or erase FLASH, and please refer to C5P factory default configuration DEMO for the specific steps.

PCle Reference Design for Windows

PCle is commonly used in consumer, server, and industrial applications, to link motherboard-mounted peripherals. From this demonstration, it will show how the PC Windows and FPGA communicate with each other through the PCle interface. Avalon-MM Cyclone V Hard IP for PCle and Modular SGDMA are used in this demonstration. For details about this Modular SGDMA, please refer to Intel document http://www.alterawiki.com/wiki/File:MSGDMA_Docs.zip

7.1 PCle System Infrastructure

Figure 7-1 shows the infrastructure of the PCle System in this demonstration. It consists of two primary components: FPGA System and PC System. The FPGA System is developed based on Avalon-MM Cyclone V Hard IP for PCle and Modular SGDMA. The application software on the PC side is developed by Terasic based on Intel’s PCle kernel mode driver.

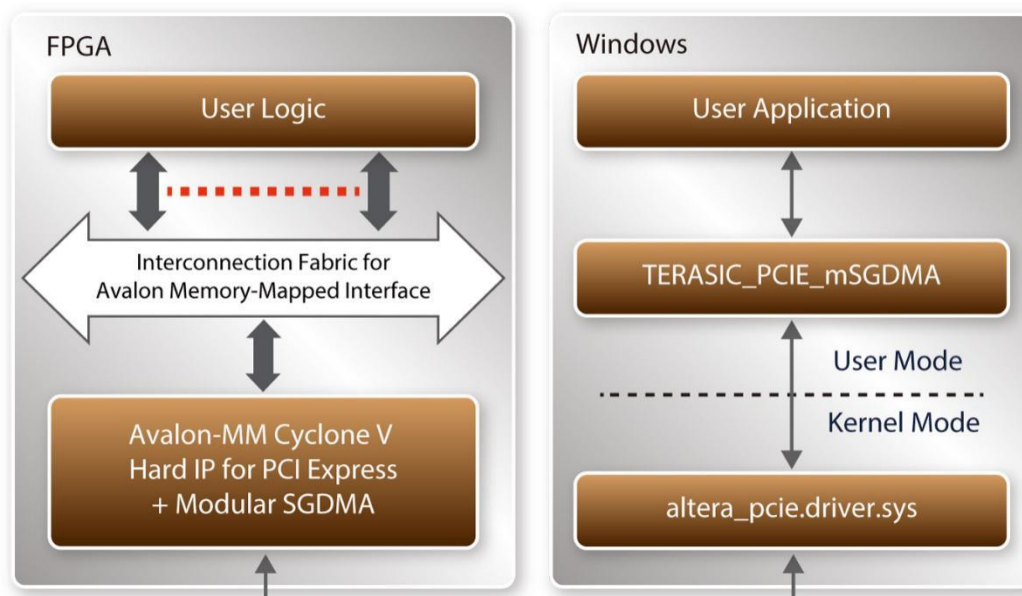

Figure 7-1 Infrastructure of PCle System

7.2 PC PCIe Software SDK

The FPGA System CD contains a SDK based Windows PC to allow users to develop their 64-bit software application on 64-bits Windows 7 or Window XP. The SDK is located in the “CDROM\demonstrations\PCIe_SW_KIT\Windows” folder which includes:

- PCIe Driver
- PCIe Library
- PCIe Examples

The kernel mode driver assumes the PCIe vender ID (VID) is 0x1172 and the device ID (DID) is 0xE001. If different VID and DID are used in the design, users need to modify the PCIe vender ID (VID) and device ID (DID) in the driver INF file accordingly.

The PCIe Library is implemented as a single DLL named TERASIC_PCIE_mSGDMA.DLL. This file is a 64-bit DLL. With the DLL is exported to the software API, users can easily communicate with the FPGA. The library provides the following functions:

- Basic data read and write
- Data read and write by DMA

For high performance data transmission, Intel Modular SGDMA is required as the read and write operations which are specified under the hardware design on the FPGA.

7.3 PCIe Software Stack

Figure 7-2 shows the software stack for the PCIe application software on 64-bit Windows. The PCIe driver incorporated in the DLL library is called TERASIC_PCIE_mSGDMA.dll. Users can develop their applications based on this DLL. The altera_pcie_win_driver.sys kernel driver is provided by Intel.

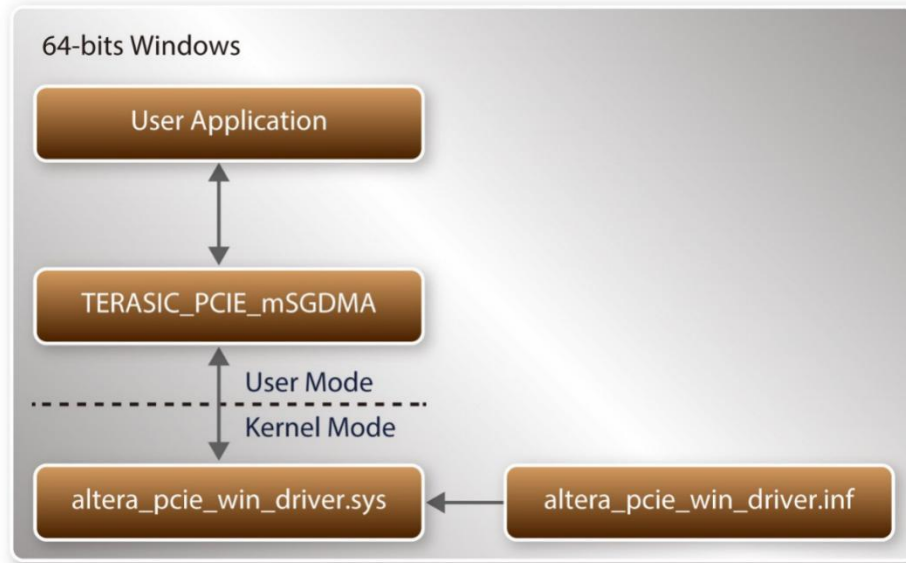

Figure 7-2 PCIe Software Stack

■ Install PCIe Driver on Windows

The PCIe driver is located in the folder:

“CDROM\Demonstrations\PCIe_SW_KIT\Windows\PCIe_Driver “

The folder includes the following four files:

- Altera_pcie_win_driver.cat
- Altera_pcie_win_driver.inf
- Altera_pcie_win_driver.sys
- WdfCoinstaller01011.dll

To install the PCIe driver, please execute the steps below:

1. Install the C5P on the PCIe slot of the host PC.
2. Make sure the Intel Programmer and USB-Blaster II driver are installed.
3. Execute test.bat in “CDROM\Demonstrations\C5P_PCIe_Fundamental\demo_batch” to configure the FPGA.
4. Restart Windows operation system.
5. Click the Control Panel menu from Windows Start menu. Click the Hardware and Sound item before clicking the Device Manager to launch the Device Manager dialog. There will be a PCI Device item in the dialog, as shown in **Figure 7-3**, Move the mouse cursor to the PCI Device item and right click it to select the Update Driver Software... items.

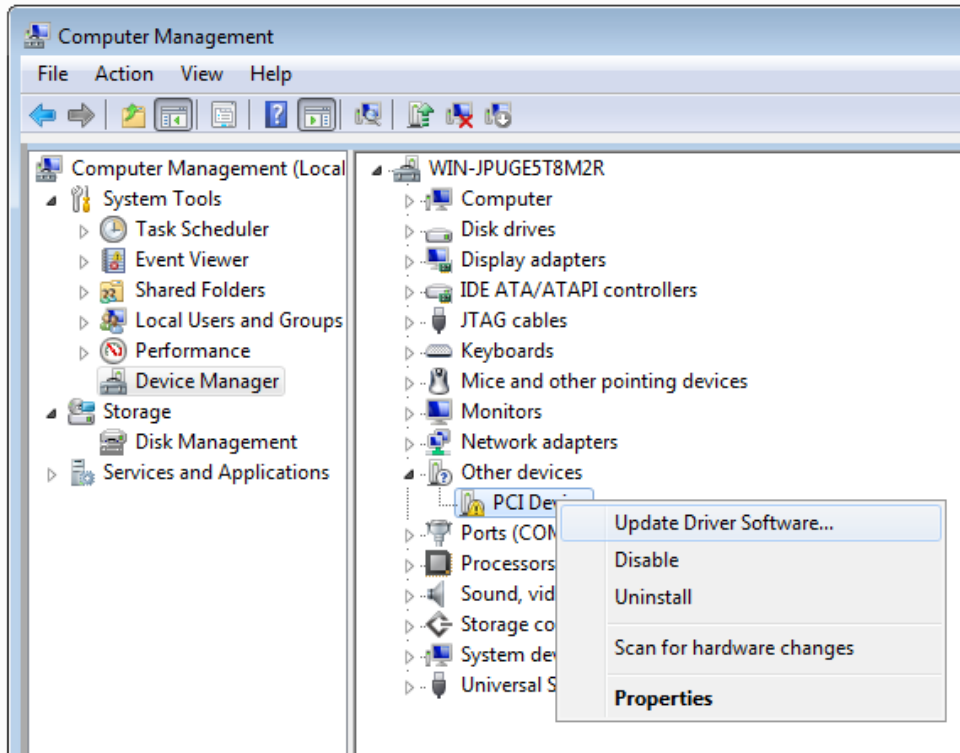

Figure 7-3 Screenshot of launching Update Driver Software... dialog

6. In the **How do you want to search for driver software** dialog, click **Browse my computer for the driver software** item, as shown in **Figure 7-4**.

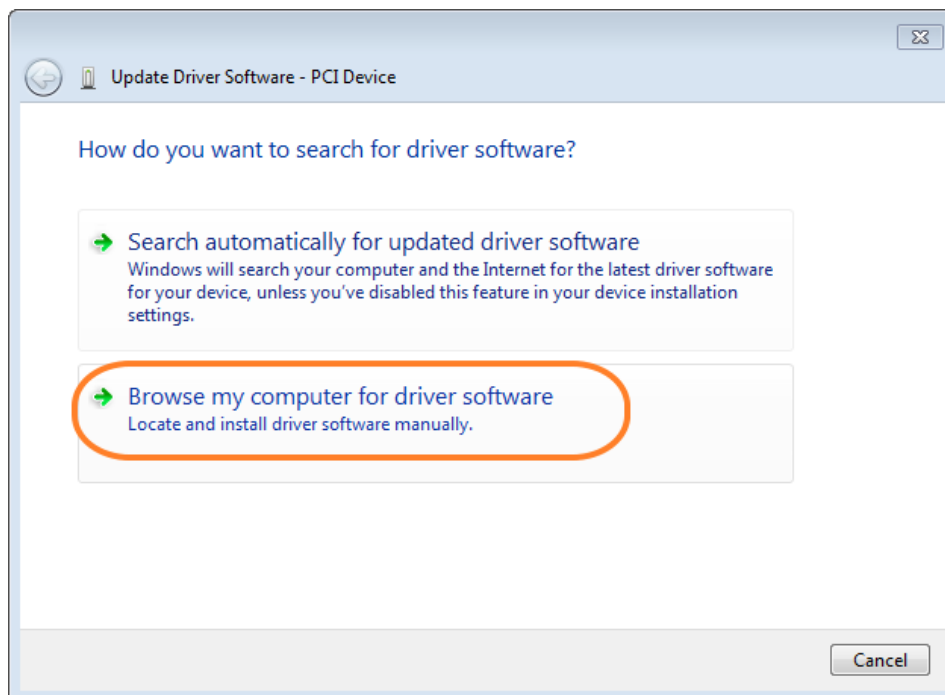

Figure 7-4 Dialog of Browse my computer for driver software

7. In the **Browse for driver software on your computer** dialog, click the **Browse** button to specify the folder where altera_pcie_din_driver.inf is located, as shown in **Figure 7-5**. Click the **Next** button.

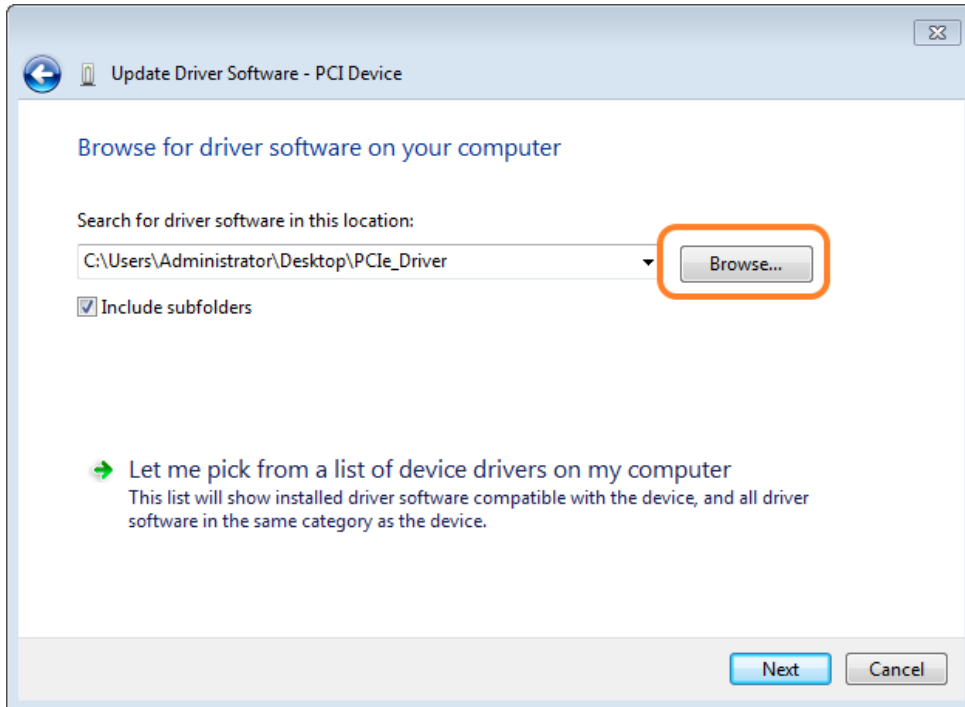

Figure 7-5 Browse for driver software on your computer

8. When the Windows Security dialog appears, as shown in **Figure 7-6**, click the **Install** button.

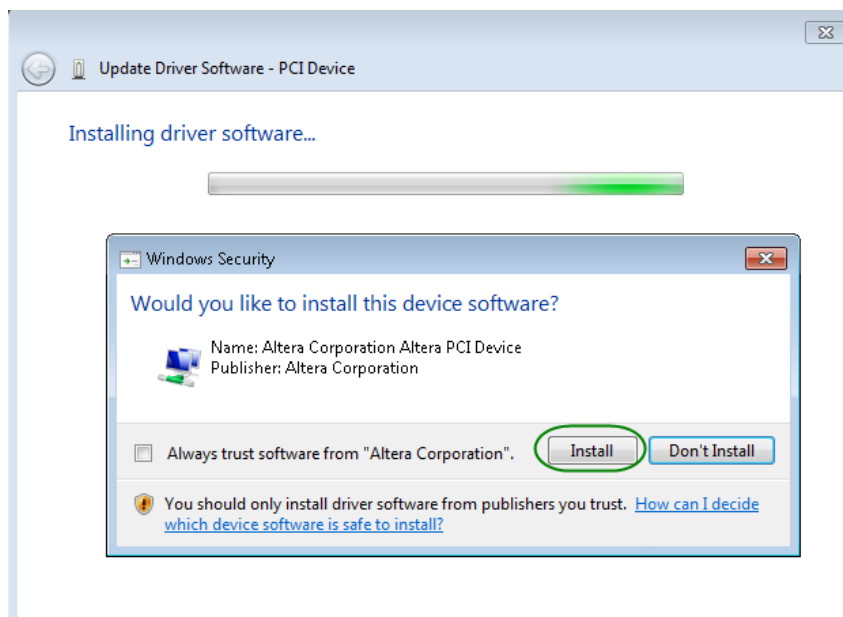

Figure 7-6 Click Install in the dialog of Windows Security

9. Once the driver is successfully installed, users can see the **Altera PCI API Driver** under the device manager window, as shown in **Figure 7-7**.

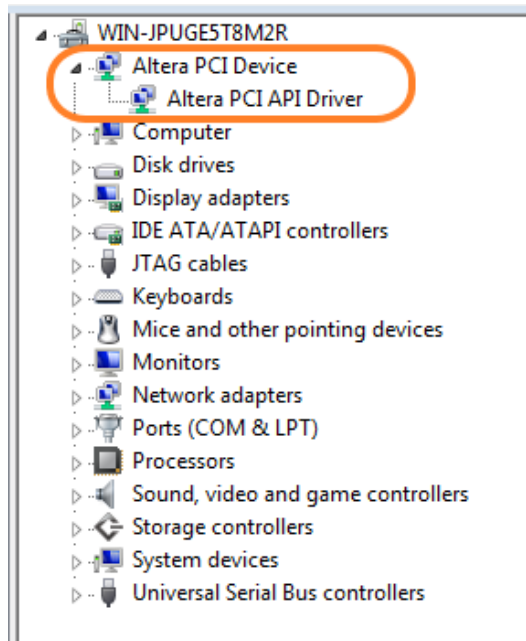

Figure 7-7 Altera PCI API Driver in Device Manager

■ Create a Software Application

All the files needed to create a PCIe software application are located in the directory: CDROM\Demonstration\PCIe_SW_KIT\Windows\PCIe_Library, it includes the following files:

- TERASIC_PCIE_mSGDMA.h
- TERASIC_PCIE_mSGDMA.DLL (64-bit DLL)

Below list the procedures to use the SDK files in users' C/C++ project:

1. Create a 64-bit C/C++ project
2. Include TERASIC_PCIE_mSGDMA.h in the C/C++ project
3. Copy TERASIC_PCIE_mSGDMA.DLL to the folder where the project.exe is located.
4. Dynamically load TERASIC_PCIE_mSGDMA.DLL in C/C++ program. To load the DLL, please refer to the PCIe fundamental example below.
5. Call the SDK API to implement the desired application.

Users can easily communicate with the FPGA through the PCIe bus by the TERASIC_PCIE_mSGDMA.DLL API. The details of API are described below.

7.4 PCIe Library API

Below shows the exported API in the Terasic_PCIE_MsgDMA.DLL. The API prototype is defined in the Terasic_PCIE_MsgDMA.h.

Note: the Linux library `terasic_pcie_qsys.so` also use the same API and header file.

■ PCIe_Open

Function:	Open a specified PCIe card with vendor ID, device ID, and matched card index.
Prototype:	<pre>PCIE_HANDLE PCIE_Open(uint8_t wVendorID, uint8_t wDeviceID, uint8_t wCardIndex);</pre>
Parameters:	<p>wVendorID: Specify the desired vendor ID. A zero value means to ignore the vendor ID.</p> <p>wDeviceID: Specify the desired device ID. A zero value means to ignore the device ID.</p> <p>wCardIndex: Specify the matched card index, a zero based index, based on the matched vendor ID and deviceID.</p>
Return Value:	<p>Return a handle to presents specified PCIe card. A positive value is return if the PCIe card is opened successfully. A value zero means failed to connect the target PCIe card. This handle value is used as a parameter for other functions, e.g. <code>PCIE_Read32</code>. Users need to call <code>PCIE_Close</code> to release handle once the handle is no more used.</p>

■ PCIe_Close

Function:	Close a handle associated to the PCIe card.
Prototype:	<pre>void PCIE_Close(PCIE_HANDLE hPCIE);</pre>
Parameters:	<p>hPCIE: A PCIe handle return by <code>PCIE_Open</code> function.</p>
Return Value:	

None.

■ PCIE_Read32

Function:

Read a 32-bit data from the FPGA board.

Prototype:

```
bool PCIE_Read32(
    PCIE_HANDLE hPCIE,
    PCIE_BAR PcieBar,
    PCIE_ADDRESS PcieAddress,
    uint32_t *pdwData);
```

Parameters:

hPCIE:

A PCIe handle return by PCIE_Open function.

PcieBar:

Specify the target BAR.

PcieAddress:

Specify the target address in FPGA.

pdwData:

A buffer to retrieve the 32-bit data.

Return Value:

Return **true** if read data is successful; otherwise **false** is returned.

■ PCIE_Write32

Function:

Write a 32-bit data to the FPGA Board.

Prototype:

```
bool PCIE_Write32(
    PCIE_HANDLE hPCIE,
    PCIE_BAR PcieBar,
    PCIE_ADDRESS PcieAddress,
    uint32_t dwData);
```

Parameters:

hPCIE:

A PCIe handle return by PCIE_Open function.

PcieBar:

Specify the target BAR.

<p>PcieAddress: Specify the target address in FPGA.</p> <p>dwData: Specify a 32-bit data which will be written to FPGA board.</p>
<p>Return Value: Return true if write data is successful; otherwise false is returned.</p>

■ PCIE_Write8

<p>Function: Write an 8-bit data to the FPGA Board.</p>
<p>Prototype:</p> <pre>bool PCIE_Write8(PCIE_HANDLE hPCIE, PCIE_BAR PcieBar, PCIE_ADDRESS PcieAddress, uint8_t Byte);</pre>
<p>Parameters:</p> <p>hPCIE: A PCIe handle return by PCIE_Open function.</p> <p>PcieBar: Specify the target BAR.</p> <p>PcieAddress: Specify the target address in FPGA.</p> <p>Byte: Specify an 8-bit data which will be written to FPGA board.</p>
<p>Return Value: Return true if write data is successful; otherwise false is returned.</p>

■ PCIE_DmaRead

<p>Function: Read data from the memory-mapped memory of FPGA board in DMA. Maximal read size is (1GB-1) bytes.</p>
<p>Prototype:</p> <pre>bool PCIE_DmaRead(PCIE_HANDLE hPCIE, PCIE_LOCAL_ADDRESS LocalAddress, void *pBuffer,</pre>

<pre>uint32_t dwBufSize);</pre>
<p>Parameters:</p> <p>hPCIE: A PCIe handle return by PCIE_Open function.</p> <p>LocalAddress: Specify the target memory-mapped address in FPGA.</p> <p>pBuffer: A pointer to a memory buffer to retrieve the data from FPGA. The size of buffer should be equal or larger the dwBufSize.</p> <p>dwBufSize: Specify the byte number of data retrieved from FPGA.</p>
<p>Return Value: Return true if read data is successful; otherwise false is returned.</p>

■ PCIE_DmaWrite

<p>Function: Write data to the memory-mapped memory of FPGA board in DMA.</p>
<p>Prototype:</p> <pre>bool PCIE_DmaWrite(PCIE_HANDLE hPCIE, PCIE_LOCAL_ADDRESS LocalAddress, void *pData, uint32_t dwDataSize);</pre>
<p>Parameters:</p> <p>hPCIE: A PCIe handle return by PCIE_Open function.</p> <p>LocalAddress: Specify the target memory mapped address in FPGA.</p> <p>pData: A pointer to a memory buffer to store the data which will be written to FPGA.</p> <p>dwDataSize: Specify the byte number of data which will be written to FPGA.</p>
<p>Return Value: Return true if write data is successful; otherwise false is returned.</p>

■ PCIE_ConfigRead32

Function:	Read PCIe Configuration Table. Read a 32-bit data by given a byte offset.
Prototype:	<pre>bool PCIE_ConfigRead32 (PCIE_HANDLE hPCIE, uint32_t Offset, uint32_t *pdwData);</pre>
Parameters:	<p>hPCIE: A PCIe handle return by PCIE_Open function.</p> <p>Offset: Specify the target byte of offset in PCIe configuration table.</p> <p>pdwData: A 4-bytes buffer to retrieve the 32-bit data.</p>
Return Value:	Return true if read data is successful; otherwise false is returned.

■ PCIE_ConfigRead8

Function:	Read PCIe Configuration Table. Read a 8-bit data by given a byte offset.
Prototype:	<pre>bool PCIE_ConfigRead8 (PCIE_HANDLE hPCIE, uint32_t Offset, uint8_t *pByte);</pre>
Parameters:	<p>hPCIE: A PCIe handle return by PCIE_Open function.</p> <p>Offset: Specify the target byte of offset in PCIe configuration table.</p> <p>pByte: A 1-bytes buffer to retrieve the 8-bit data.</p>
Return Value:	Return true if read data is successful; otherwise false is returned.

7.5 PCIe Reference Design - Fundamental

The application reference design shows how to implement fundamental control and data transfer in DMA. In the design, basic I/O is used to control the BUTTON and LED on the FPGA board. High-speed data transfer is performed by the DMA.

■ Demonstration Files Location

The demo file is located in the batch folder:

CDROM\demonstrations\C5P_PcIe_Fundamental\demo_batch

The folder includes following files:

- FPGA Configuration File: C5P_PcIe_Fundamental.sof
- Download Batch file: test.bat
- Windows Application Software folder: windows_app, includes:
 - PCIE_FUNDAMENTAL.exe
 - TERASIC_PCIE_mSGDMA.dll

■ Demonstration Setup

1. Install the FPGA board on your PC as shown in **Figure 7-8**.



Figure 7-8 FPGA board installation on PC

2. Configure FPGA with C5P_PcIe_Fundamental.sof by executing the test.bat.
3. Make sure the PCIe driver is installed. The driver is located in the folder:
CDROM\Demonstration\PCIE_SW_KIT\Windows\PCIE_Driver.
4. Restart Windows
5. Make sure that Windows has detected the FPGA Board by checking the Windows Control panel as shown in **Figure 7-9**.

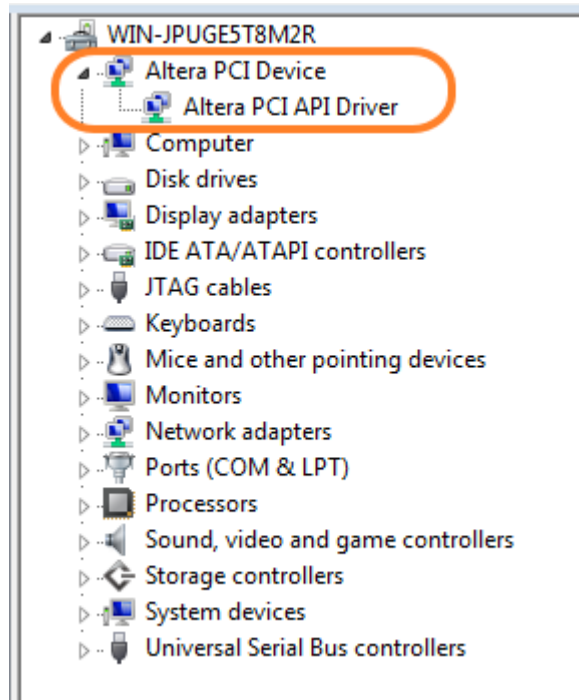

Figure 7-9 Screenshot for PCIe Driver

6. Goto windows_app folder, execute PCIE_FUNDAMENTAL.exe. A menu will appear as shown in **Figure 7-10**.

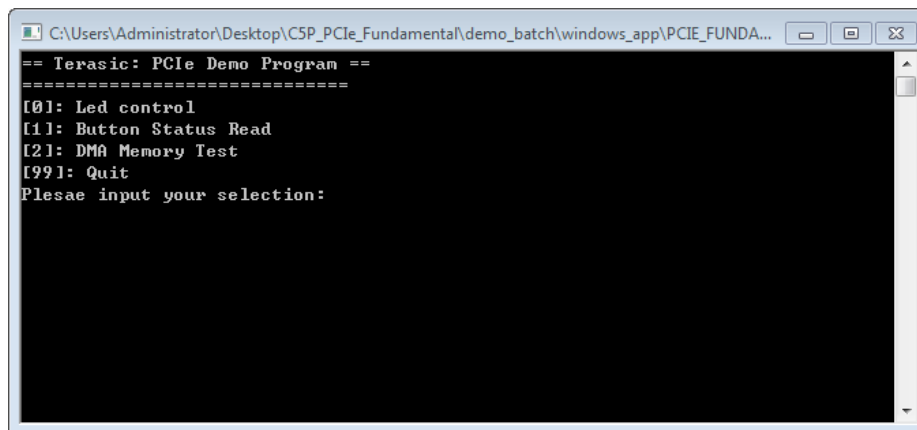

Figure 7-10 Screenshot of Program Menu

7. Type 0 followed by a ENTER key to select Led Control item, then input 15(hex 0x0f) will make all led on as shown in **Figure 7-11**. If input 0(hex 0x00), all led will be turned off.

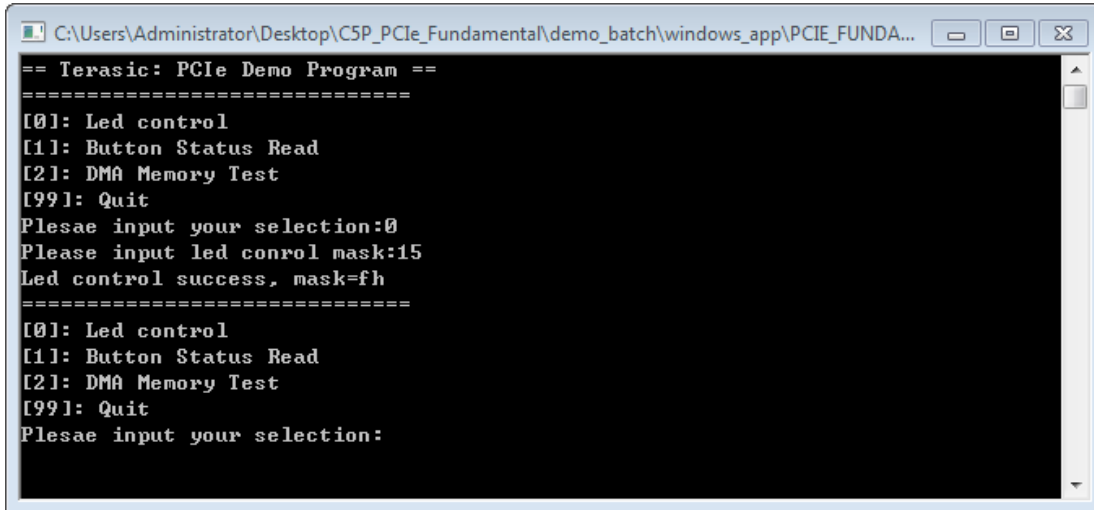

Figure 7-11 Screenshot of LED Control

8. Type 1 followed by an ENTER key to select Button Status Read item. The button status will be report as shown in **Figure 7-12**.

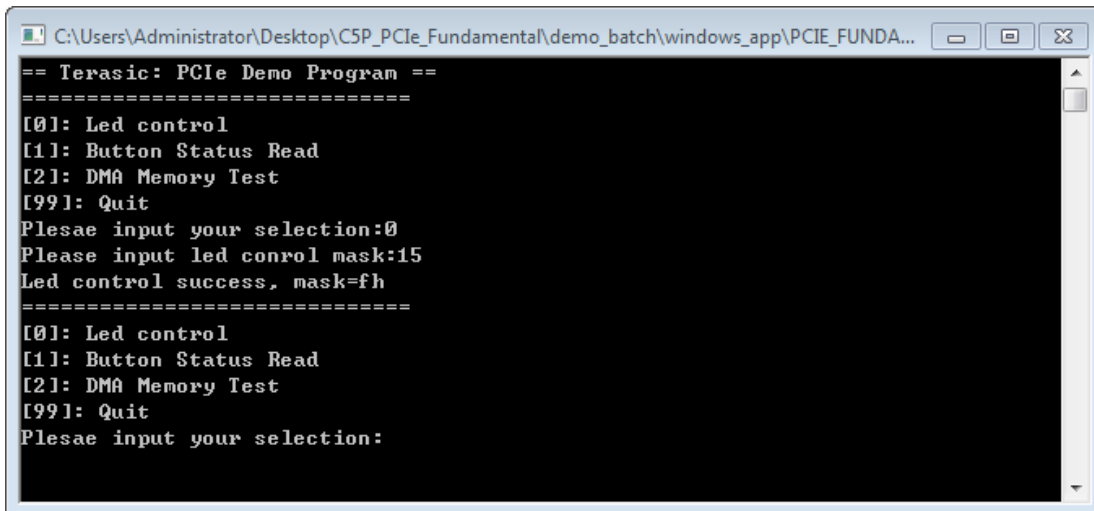

Figure 7-12 Screenshot of Button Status Report

9. Type 2 followed by an ENTER key to select the DMA Testing item. The DMA test result will be reported as shown in **Figure 7-13**.

```

C:\Users\Administrator\Desktop\C5P_PCl_e_Fundamental\demo_batch\windows_app\PCIE_FUNDA...
== Terasic: PCIe Demo Program ==
=====
[0]: Led control
[1]: Button Status Read
[2]: DMA Memory Test
[99]: Quit
Plesae input your selection:0
Please input led conrol mask:15
Led control success, mask=fh
=====
[0]: Led control
[1]: Button Status Read
[2]: DMA Memory Test
[99]: Quit
Plesae input your selection:1
Button status mask:=fh
=====
[0]: Led control
[1]: Button Status Read
[2]: DMA Memory Test
[99]: Quit
Plesae input your selection:2
DMA-Memory <Size = 524288 bytes> pass
=====

```

Figure 7-13 Screenshot of DMA Memory Test Result

10. Type 99 followed by the ENTER key to exit this test program.

■ Development Tools

- Quartus Prime 17.1 Standard Edition
- Visual C++ 2012

■ Demonstration Source Code Location

- Quartus Project: Demonstration\C5P_PCl_e_Fundamental
- C++ Project; Demonstration\PCl_e_SW_KIT\Windows\PCIE_FUNDAMENTAL

■ FPGA Application Design

Figure 7-14 shows the system block diagram in the FPGA system. In the Qsys, PIO controller is used to control the LED and monitor the Button Status, and the On-Chip memory is used for performing DMA testing. The PIO controllers and the On-Chip memory are connected to the PCIe Hard IP controller through the Memory-Mapped Interface.

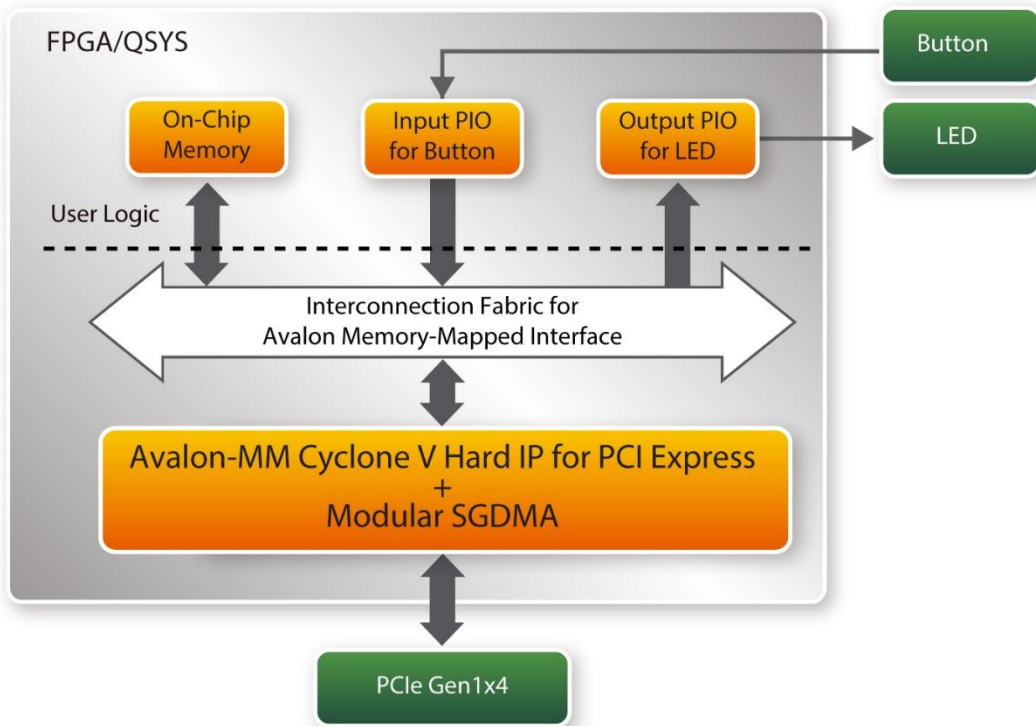

Figure 7-14 Hardware block diagram of the PCIe reference design

■ Windows Based Application Software Design

The application software project is built by Visual C++ 2012. The project includes the following major files:

Name	Description
PCIE_FUNDAMENTAL.cpp	Main program
PCIE.c	Implement dynamically load for
PCIE.h	TERAISC_PCIE_mSGDMA.DLL
TERASIC_PCIE_mSGDMA.h	SDK library file, defines constant and data structure

The main program PCIE_FUNDAMENTAL.cpp includes the header file "PCIE.h" and defines the controller address according to the FPGA design.

```
#include "PCIE.h"

#define DEMO_PCIE_USER_BAR          PCIE_BAR4
#define DEMO_PCIE_IO_LED_ADDR       0x4000010
#define DEMO_PCIE_IO_BUTTON_ADDR    0x4000020
#define DEMO_PCIE_MEM_ADDR          0x07000000

#define MEM_SIZE                     (512*1024) //512KB
```

The base address of BUTTON and LED controllers are 0x4000010 and 0x4000020 based on the PCIE_BAR4, respectively. The on-chip memory base address is 0x07000000 relative to the DMA controller.

Before accessing the FPGA through PCIe, the application first calls the PCIE_Load to dynamically load the Terasic_PCIE_mSGDMA.DLL. Then, it calls PCIE_Open to open the PCIe driver. The constant DEFAULT_PCIE_VID and DEFAULT_PCIE_DID used in the PCIE_Open are defined in Terasic_PCIE_mSGDMA.h. If developer change the Vendor ID and Device ID and PCIe IP, they also need to change the ID value define in Terasic_PCIE_mSGDMA.h. If the return value of PCIE_Open is zero, it means the driver cannot be accessed successfully. In this case, please make sure:

- The FPGA is configured with the associated bit-stream file and the host is rebooted.
- The PCIe driver is loaded successfully.

The LED control is implemented by calling PCIE_Write32 API, as shown below:

```
bPass = PCIE_Write32(hPCIE, DEMO_PCIE_USER_BAR, DEMO_PCIE_IO_LED_ADDR, (uint32_t) Mask);
```

The button status query is implemented by calling the PCIE_Read32 API, as shown below:

```
PCIE_Read32(hPCIE, DEMO_PCIE_USER_BAR, DEMO_PCIE_IO_BUTTON_ADDR, &Status);
```

The memory-mapped memory read and write test is implemented by PCIE_DmaWrite and PCIE_DmaRead API, as shown below:

```
PCIE_DmaWrite(hPCIE, LocalAddr, pWrite, nTestSize);
PCIE_DmaRead(hPCIE, LocalAddr, pRead, nTestSize);
```

7.6 PCIe Reference Design – DDR3

The application reference design shows how to add the DDR3 Memory Controllers for the on board DDR3 into the PCIe Quartus project based on the C5P_PCl_e_Fundamental Quartus project and perform 1GB data DMA for both memory. Also, this demo shows how to call “PCIE_ConfigRead32” API to check PCIe link status.

■ Demonstration Files Location

The demo file is located in the batch folder:

CDROM\demonstrations\C5P_PCl_e_DDR3\demo_batch

The folder includes following files:

- FPGA Configuration File: C5P_PCl_e_DDR3.sof
- Download Batch file: test.bat
- Windows Application Software folder: windows_app, includes
 - PCIE_DDR3.exe
 - TERASIC_PCl_e_mSGDMA.dll

■ Demonstration Setup

1. Install the FPGA board on your PC.
2. Configure the FPGA with the PCIE_DDR3.sof by executing the test.bat.
3. Restart Windows.
4. Make sure that Windows has detected the FPGA Board by checking the Windows Control panel.
5. Goto windows_app folder, execute PCIE_DDR3.exe. A menu will appear as shown in **Figure 7-15**.

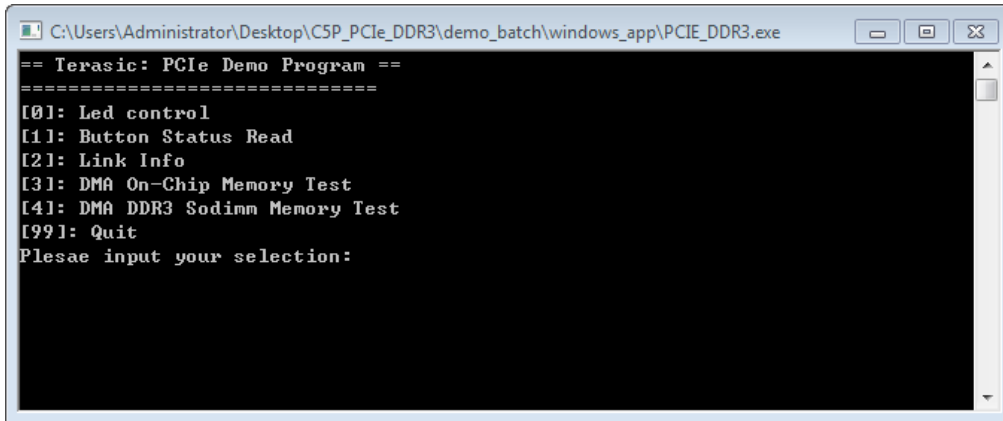

Figure 7-15 Screenshot of Program Menu

6. Type 2 followed by the ENTER key to select the Link Info item. The PCIe link information will be shown as in **Figure 7-16**.

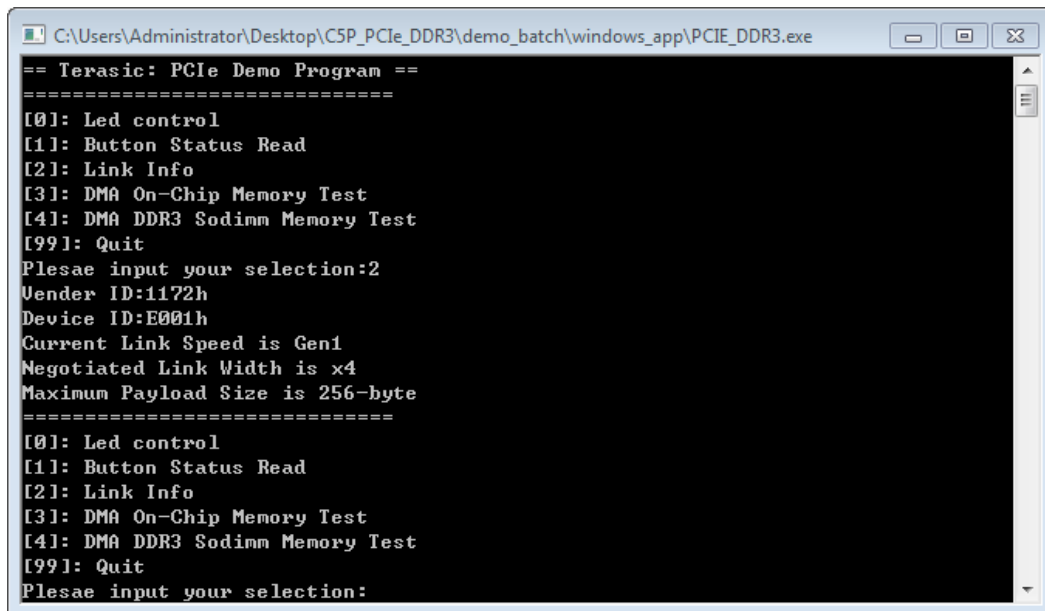

Figure 7-16 Screenshot of Link Info

7. Type 3 followed by the ENTER key to select the DMA On-Chip Memory Test item. The DMA write and read test result will be reported as shown in **Figure 7-17**.

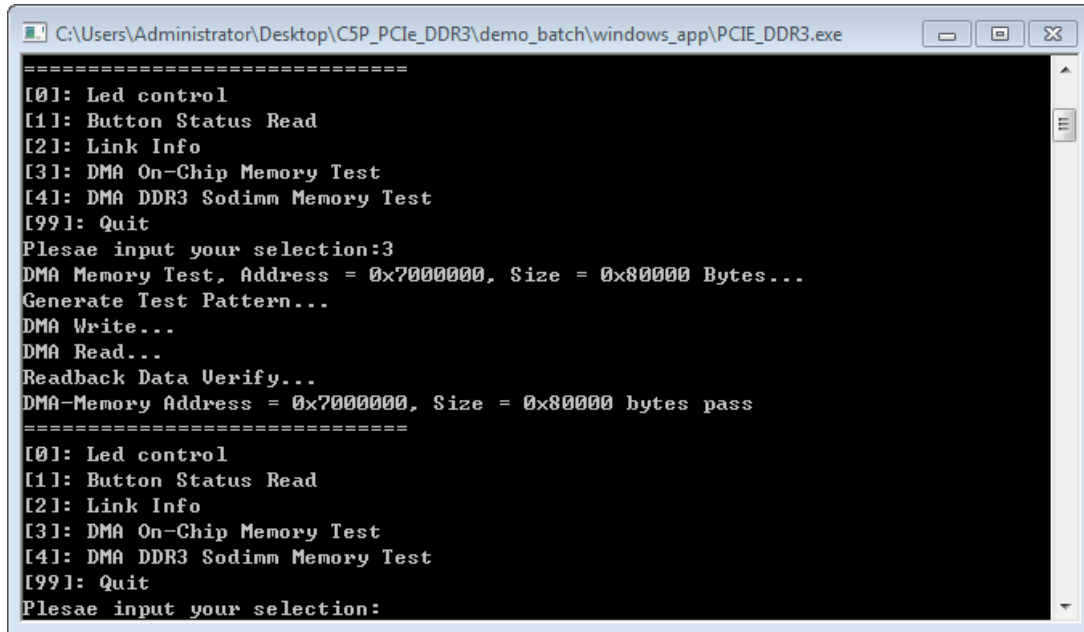

Figure 7-17 Screenshot of the On-Chip Memory DMA Test Result

8. Type 4 followed by the ENTER key to select the DMA DDR3 Memory Test item. The DMA write and read test result will be reported as shown in [Figure 7-18](#).

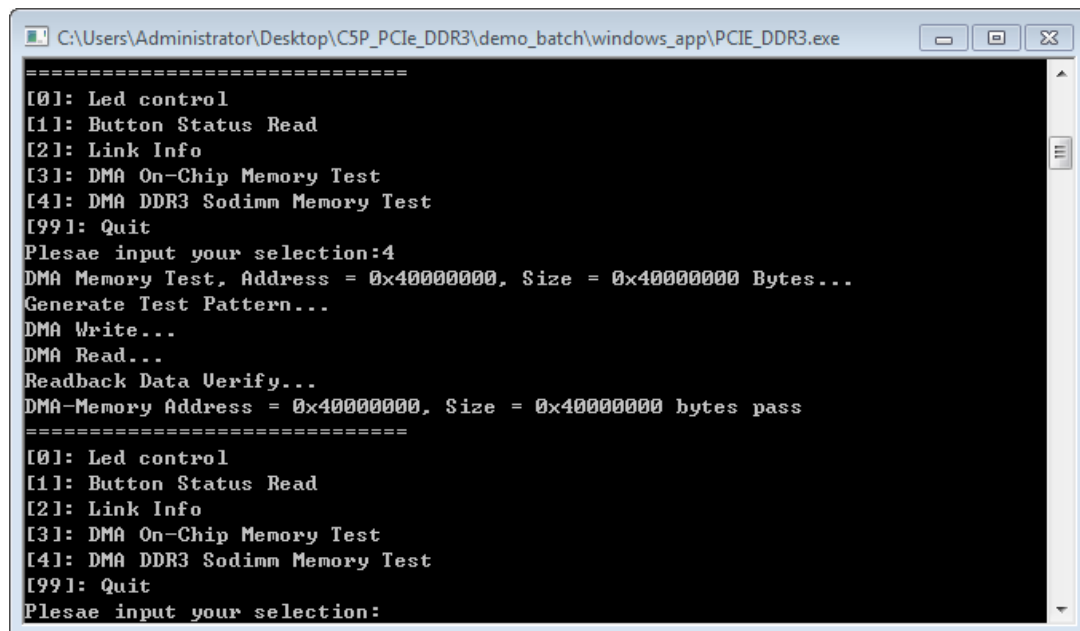

Figure 7-18 Screenshot of DDR3 Memory DAM Test Result

9. Type 99 followed by the ENTER key to exit this test program.

■ **Development Tools**

- Quartus Prime 17.1 Standard Edition
- Visual C++ 2012

■ **Demonstration Source Code Location**

- Quartus Project: Demonstration\PCIE_DDR3
- Visual C++ Project: Demonstration\PCie_SW_KIT\Windows\PCIE_DDR3

■ **FPGA Application Design**

Figure 7-19 shows the system block diagram in the FPGA system. In the Qsys, PIO controller is used to control the LED and monitor the Button Status, and the On-Chip memory and DDR3 memory are used for performing DMA testing. The PIO controllers and the memory are connected to the PCIe Hard IP controller through the Memory-Mapped Interface.

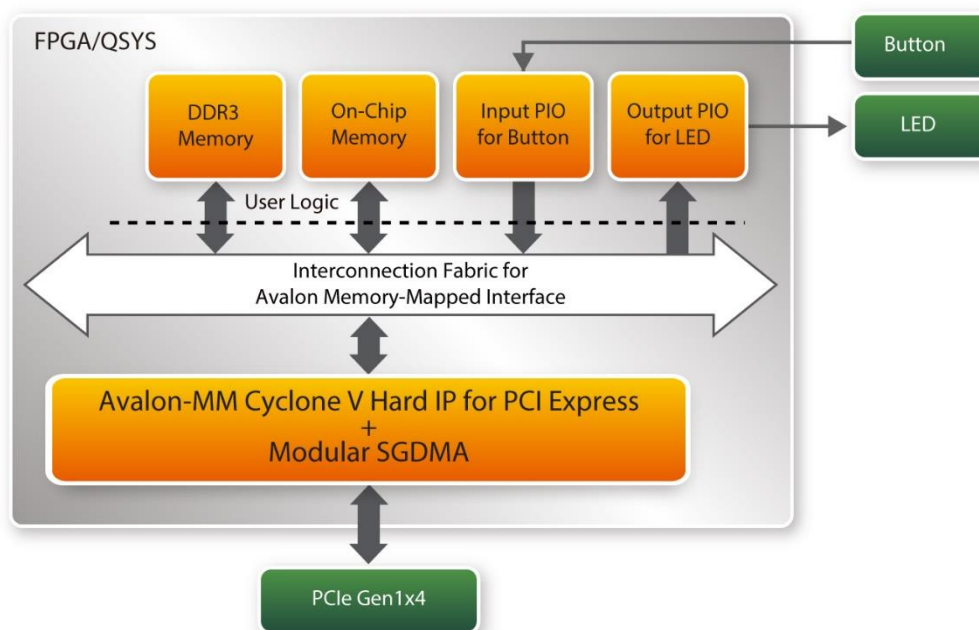

Figure 7-19 Hardware block diagram of the PCIe_DDR3 reference design

■ **Windows Based Application Software Design**

The application software project is built by Visual C++ 2012. The project includes the following major files:

Name	Description
------	-------------

PCIE_DDR3.cpp	Main program
PCIE.c	Implement dynamically load for
PCIE.h	TERASIC_PCIE_mSGDMA.DLL
TERASIC_PCIE_mSGDMA.h	SDK library file, defines constant and data structure

The main program PCIE_DDR3.cpp includes the header file "PCIE.h" and defines the controller address according to the FPGA design.

```
#define DEMO_PCIE_USER_BAR          PCIE_BAR4
#define DEMO_PCIE_IO_LED_ADDR      0x4000010
#define DEMO_PCIE_IO_BUTTON_ADDR  0x4000020
#define DEMO_PCIE_ONCHIP_MEM_ADDR 0x07000000
#define DEMO_PCIE_DDR3_MEM_ADDR   0x40000000

#define ONCHIP_MEM_TEST_SIZE      (512*1024) //512KB
#define DDR3_MEM_TEST_SIZE        (1*1024*1024*1024) //1GB
#define DMA_CHUNK_SIZE            (1*1024*1024*1024) //1GB
```

The above definition is the same as those in PCIE_Fundamental demo.

Before accessing the FPGA through PCIe, the application first calls PCIE_Load to dynamically load the TERASIC_PCIE_mSGDMA.DLL. Then, it calls PCIE_Open to open the PCIe driver. The constant DEFAULT_PCIE_VID and DEFAULT_PCIE_DID used in the PCIE_Open are defined in TERASIC_PCIE_mSGDMA.h. If developer changes the Vender ID and Device ID and PCI Express IP, they also need to change the ID value defined in TERASIC_PCIE_mSGDMA.h. If the return value of PCIE_Open is zero, it means the driver cannot be accessed successfully. In this case, please make sure:

- The FPGA is configured with the associated bit-stream file and the host is rebooted.
- The PCIe driver is loaded successfully.

The LED control is implemented by calling PCIE_Write32 API, as shown below:

```
bPass = PCIE_Write32(hPCIE, DEMO_PCIE_USER_BAR, DEMO_PCIE_IO_LED_ADDR, (uint32_t)
```

The button status query is implemented by calling the **PCIE_Read32** API, as shown below:

```
PCIE_Read32(hPCIE, DEMO_PCIE_USER_BAR, DEMO_PCIE_IO_BUTTON_ADDR, &Stat
```

The memory-mapped memory read and write test is implemented by **PCIE_DmaWrite** and **PCIE_DmaRead** API, as shown below:

```
PCIE_DmaWrite(hPCIE, LocalAddr, pWrite, nTestSize);  
PCIE_DmaRead(hPCIE, LocalAddr, pRead, nTestSize);
```

The pcie link information is implemented by PCIE_ConfigRead32 API, as shown below:

```
// read config - link status  
if (PCIE_ConfigRead32(hPCIE, 0x90, &Data32)){  
    switch((Data32 >> 16) & 0x0F){  
        case 1:  
            printf("Current Link Speed is Gen1\r\n");  
            break;  
        case 2:  
            printf("Current Link Speed is Gen2\r\n");  
            break;  
        case 3:  
            printf("Current Link Speed is Gen3\r\n");  
            break;  
        default:  
            printf("Current Link Speed is Unknown\r\n");  
            break;  
    }  
    switch((Data32 >> 20) & 0x3F){  
        case 1:  
            printf("Negotiated Link Width is x1\r\n");  
            break;  
        case 2:  
            printf("Negotiated Link Width is x2\r\n");  
            break;  
        case 4:  
            printf("Negotiated Link Width is x4\r\n");  
            break;  
        case 8:  
            printf("Negotiated Link Width is x8\r\n");  
            break;  
        case 16:  
            printf("Negotiated Link Width is x16\r\n");  
            break;  
        default:  
            printf("Negotiated Link Width is Unknown\r\n");  
            break;  
    }  
}else{  
    bPass = false;  
}
```

PCIe Reference Design for Linux

PCIe is commonly used in consumer, server, and industrial applications, to link motherboard-mounted peripherals. From this demonstration, it will show how the PC Linux and FPGA communicate with each other through the PCIe interface. Avalon-MM Cyclone V Hard IP for PCI Express with Modular SGDMA IP is used in this demonstration.

For detail about Modular SGDMA, please refer to Intel document : http://www.alterawiki.com/wiki/File:MSGDMA_Docs.zip

8.1 PCIe System Infrastructure

Figure 8-1 shows the infrastructure of the PCIe System in this demonstration. It consists of two primary components: FPGA System and PC System. The FPGA System is developed based on Avalon-MM Cyclone V Hard IP for PCIe with Modular SGDMA. The application software on the PC side is developed by Terasic based on Intel's PCIe kernel mode driver.

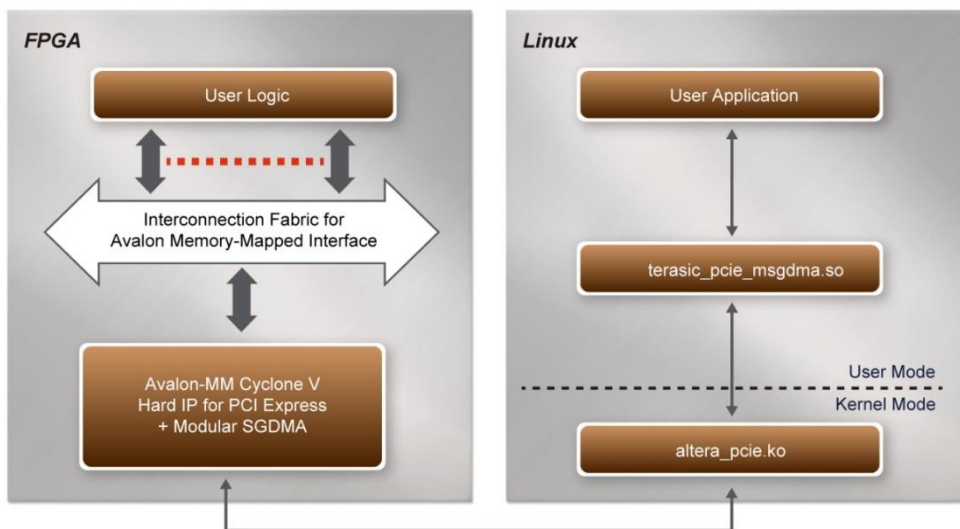

Figure 8-1 Infrastructure of PCIe System

8.2 PC PCIe Software SDK

The FPGA System CD contains a PC Windows based SDK to allow users to develop their 64-bit software application on 64-bits Linux. CentOS 7.2 is recommended. The SDK is located in the CDROM\Demonstration\PCIe_SW_KIT\Linux folder which includes:

- PCIe Driver
- PCIe Library
- PCIe Examples

The kernel mode driver assumes the PCIe vendor ID (VID) is 0x1172 and the device ID (DID) is 0xE001. If different VID and DID are used in the design, users need to modify the PCIe vendor ID (VID) and device ID (DID) in the config_file driver project.

The PCIe Library is implemented as a single .so file named terasic_pcie_msgdma.so. This file is a 64-bit library file. With the library exported software API, users can easily communicate with the FPGA. The library provides the following functions:

- Basic data read and write
- Data read and write by DMA

For high performance data transmission, Intel Modular SGDMA is required as the read and write operations are specified under the hardware design on the FPGA.

8.3 PCIe Software Stack

Figure 8-2 shows the software stack for the PCIe application software on 64-bit Linux. The PCIe driver included in the library is terasic_pcie_msgdma.so. Users can develop their applications based on this .so library file. The altera_pcie.ko kernel driver is provided by Intel.

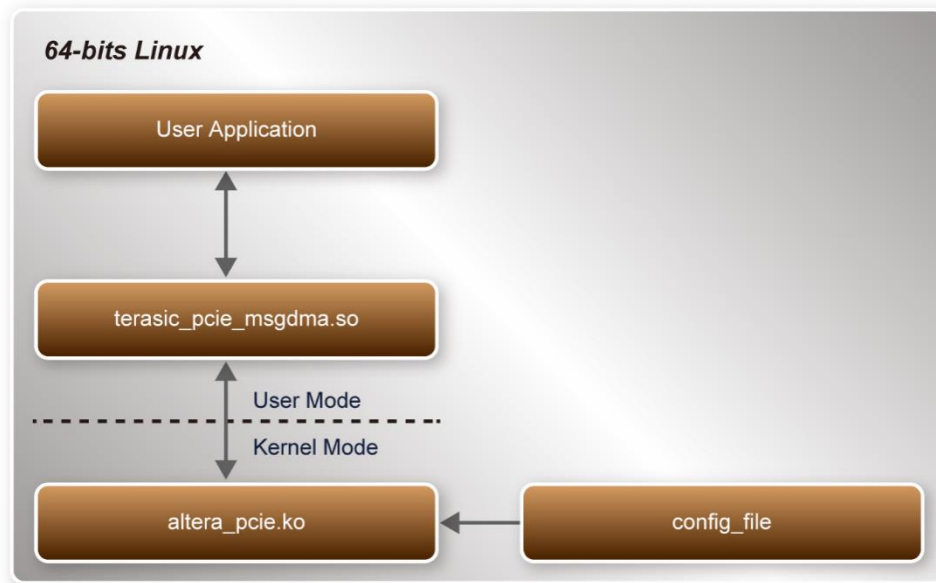

Figure 8-2 PCIe Software Stack

■ Install PCIe Driver on Linux

The PCIe driver project is located in the folder: CDRM/Demonstration/PCIe_SW_KIT/Linux/PCIe_Driver

The folder includes the following files:

- altera_pcie.c
- altera_pcie.h
- altera_pcie_cmd.h
- Makefile
- load_driver
- unload
- config_file

To compile and install the PCIe driver, please execute the steps below:

1. Install the C5P board on the PCIe slot of the host PC.
2. Make sure Quartus Programmer and USB-Blaster II driver are installed.
3. Open a terminal and use “cd” command to goto the folder “CDROM/Demonstration/C5P_PCIe_Fundamental/demo_batch”.
4. Set QUARTUS_ROOTDIR variable pointing to the Quartus installation path. Set QUARTUS_ROOTDIR variable by typing the following commands in the terminal. Replace “/home/centos/intelFPGA/17.1/quartus/” to your quartus

installation path.

export QUARTUS_ROOTDIR=/home/centos/intelFPGA/17.1/quartus/

5. Execute "sudo -E sh test.sh" command to configure the FPGA.
6. Restart the Linux operation system. In Linux, open a terminal and use "cd" command to goto the PCIe_Driver folder.
7. Type the following commands to compile and install the driver altera_pcie.ko, and make sure driver is loaded successfully and FPGA is detected by the driver as shown in **Figure 8-3**.
 - make
 - sudo sh load_driver
 - dmesg | tail -n 15

```
centos@localhost:PCIe_Driver$ sudo sh load_driver
Matching Device Found
centos@localhost:PCIe_Driver$ dmesg | tail -n 15
[ 33.606870] usb 3-5: reset high-speed USB device number 4 using xhci_hcd
[ 611.592676] Altera PCIe: altera_pcie_init(), Mar  5 2018 13:58:03
[ 611.592695] Altera PCIe 0000:01:00.0: enabling device (0000 -> 0002)
[ 611.592744] Altera PCIe 0000:01:00.0: pci_enable_device() successful
[ 611.592765] Altera PCIe 0000:01:00.0: irq 34 for MSI/MSI-X
[ 611.592770] Altera PCIe 0000:01:00.0: pci_enable_msi() successful
[ 611.592772] Altera PCIe 0000:01:00.0: BAR[0] 0xe0000000-0xe7ffffff flags 0x0014220c, length 134217728
[ 611.592773] Altera PCIe 0000:01:00.0: BAR[1] 0x00000000-0x00000000 flags 0x00000000, length 0
[ 611.592774] Altera PCIe 0000:01:00.0: BAR[2] 0xd8000000-0xdfffffff flags 0x0014220c, length 134217728
[ 611.592775] Altera PCIe 0000:01:00.0: BAR[3] 0x00000000-0x00000000 flags 0x00000000, length 0
[ 611.592776] Altera PCIe 0000:01:00.0: BAR[4] 0xd0000000-0xd7ffffff flags 0x0014220c, length 134217728
[ 611.592776] Altera PCIe 0000:01:00.0: BAR[5] 0x00000000-0x00000000 flags 0x00000000, length 0
[ 611.592790] Altera PCIe 0000:01:00.0: BAR[0] mapped to 0xffffc90040000000, length 134217728
[ 611.592794] Altera PCIe 0000:01:00.0: BAR[2] mapped to 0xffffc90050000000, length 134217728
[ 611.592798] Altera PCIe 0000:01:00.0: BAR[4] mapped to 0xffffc90060000000, length 134217728
```

Figure 8-3 Install PCIe Driver

■ Create a Software Application

All the files needed to create a PCIe software application are located in the directory: CDROM/Demonstration/PCIe_SW_KIT/Linux/PCIe_Library, It includes the following files:

- Terasic_PCIe_mSGDMA.h
- terasic_pcie_msgdma.so (64-bit Library)

Below list the procedures to use the library in users' C/C++ project:

1. Create a 64-bit C/C++ project.
2. Include Terasic_PCIe_mSGDMA.h in the C/C++ project.
3. Copy terasic_pcie_msgdma.so to the folder where the project execution file is located.
4. Dynamically load terasic_pcie_msgdma.so in C/C++ program. To load the

terasic_pcie_msgdma.so, please refer to the PCIe fundamental example below.

5. Call the library SDK API to implement the desired application.

Users can easily communicate with the FPGA through the PCIe bus through the terasic_pcie_msgdma.so API.

8.4 PCIe Library API

The API is the same as Windows Library. Please refer to the section **PCIe API**.

8.5 PCIe Reference Design - Fundamental

The application reference design shows how to implement fundamental control and data transfer in the DMA. In the design, basic I/O is used to control the BUTTON and LED on the FPGA board. High-speed data transfer is performed by the DMA.

■ Demonstration Files

The demo file is located in the batch folder: CDROM/Demonstration/C5P_PCIe_Fundamental/demo_batch/

The folder includes following files:

- FPGA Configuration File: C5P_PCIe_Fundamental.sof
- Download Batch file: test.sh
- Linux Application Software folder: linux_app, includes:
 - PCIE_FUNDAMENTAL
 - terasic_pcie_msgdma.so

■ Demonstration Setup

1. Install the FPGA board on your PC as shown in **Figure 8-4**.

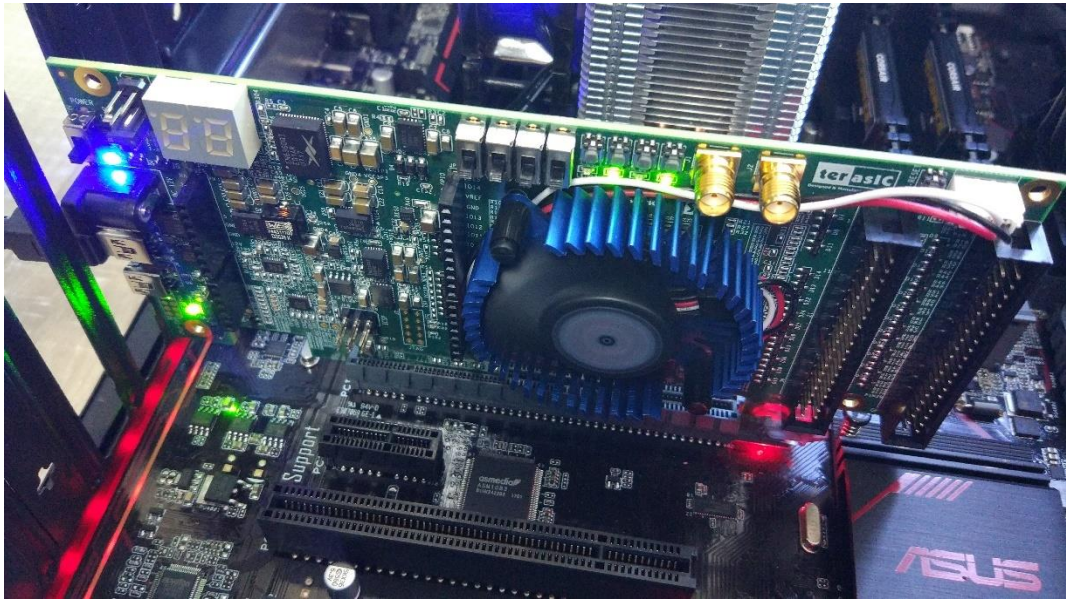

Figure 8-4 FPGA board installation on PC

2. Open a terminal and use "cd" command to goto "CDROM/Demonstration/C5P_PCl_e_Fundamental/demo_batch".
3. Set QUARTUS_ROOTDIR variable pointing to the Quartus installation path. Set QUARTUS_ROOTDIR variable by tying the following commands in terminal. Replace "/home/centos/intelFPGA/17.1/quartus/" Quartus installation path.

```
export QUARTUS_ROOTDIR=/home/centos/intelFPGA/17.1/quartus/
```

4. Execute "sudo -E sh test.sh" command to configure the FPGA.
5. Restart Linux.
6. Install PCIe driver. The driver is located in the folder: "CDROM/Demonstration/PCl_e_SW_KIT/Linux/PCl_e_Driver"
7. Type "ls -l /dev/altera_pcie*" to make sure the Linux has detected the FPGA Board. If the FPGA board is detected, developers can find the /dev/altera_pcieX (where X is 0~255) in Linux file system as shown in **Figure 8-5**.

```
centos@localhost:PCl_e_Driver$ ls -l /dev/altera_pcie*  
crw-rw-rw-. 1 root wheel 244, 0 Mar  5 13:58 /dev/altera_pcie0  
centos@localhost:PCl_e_Driver$
```

Figure 8-5 Detect FPGA PCIe

8. Goto linux_app folder, execute PCIE_FUNDAMENTAL. A menu will appear as shown in **Figure 8-6**.

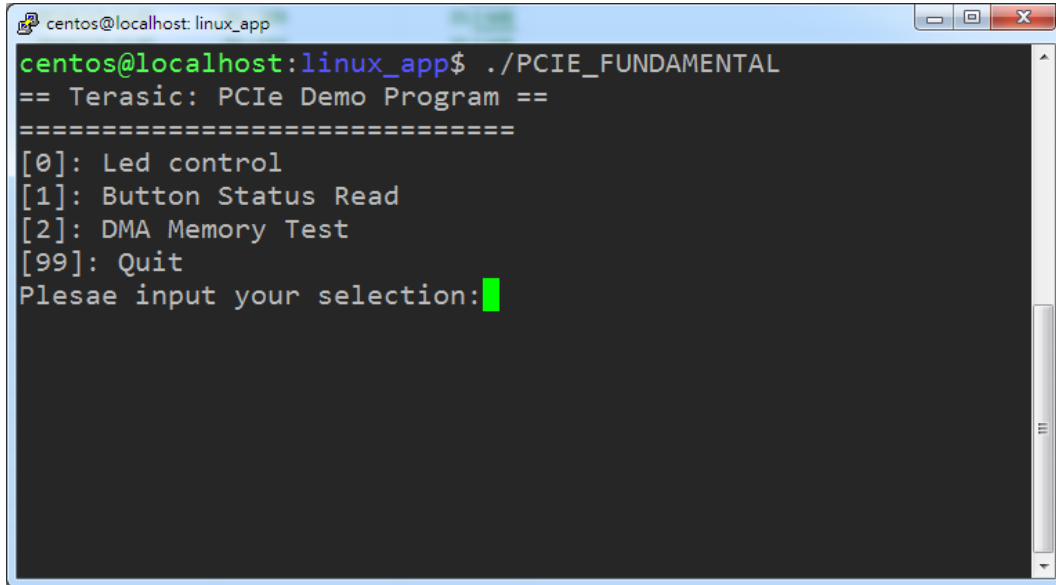

```
centos@localhost: linux_app
centos@localhost:linux_app$ ./PCIE_FUNDAMENTAL
== Terasic: PCIe Demo Program ==
=====
[0]: Led control
[1]: Button Status Read
[2]: DMA Memory Test
[99]: Quit
Plesae input your selection:█
```

Figure 8-6 Screenshot of Program Menu

9. Type 0 followed by the ENTER key to select the Led Control item, then input 15 (hex 0x0f) will turn all leds on as shown in **Figure 8-7**. If input 0 (hex 0x00), all the leds will be turned off.

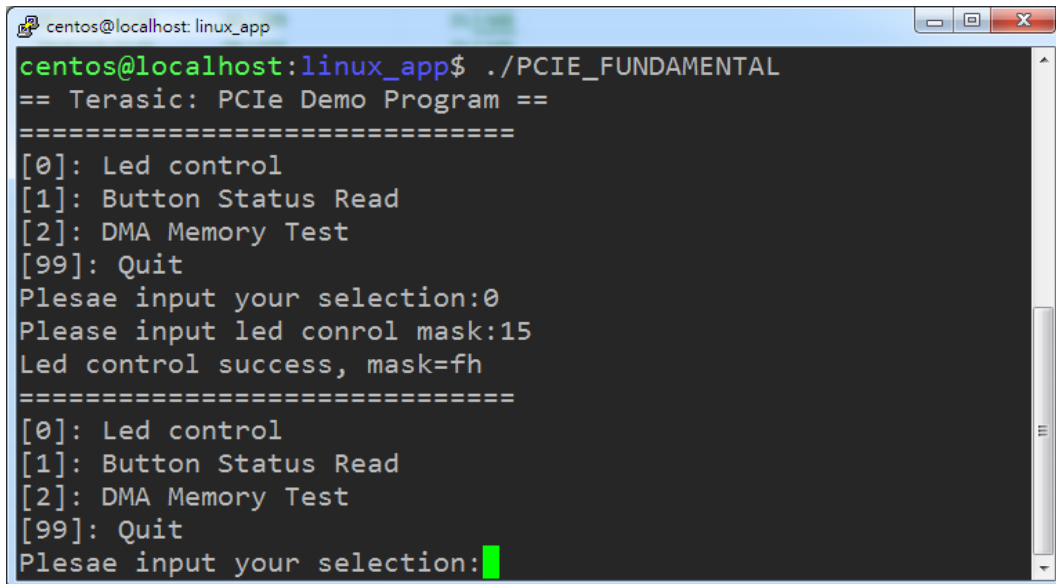

```
centos@localhost: linux_app
centos@localhost:linux_app$ ./PCIE_FUNDAMENTAL
== Terasic: PCIe Demo Program ==
=====
[0]: Led control
[1]: Button Status Read
[2]: DMA Memory Test
[99]: Quit
Plesae input your selection:0
Please input led conrol mask:15
Led control success, mask=fh
=====
[0]: Led control
[1]: Button Status Read
[2]: DMA Memory Test
[99]: Quit
Plesae input your selection:█
```

Figure 8-7 LED Control

10. Type 1 followed by the ENTER key to select the Button Status Read item. The button status will be reported as shown in **Figure 8-8**.

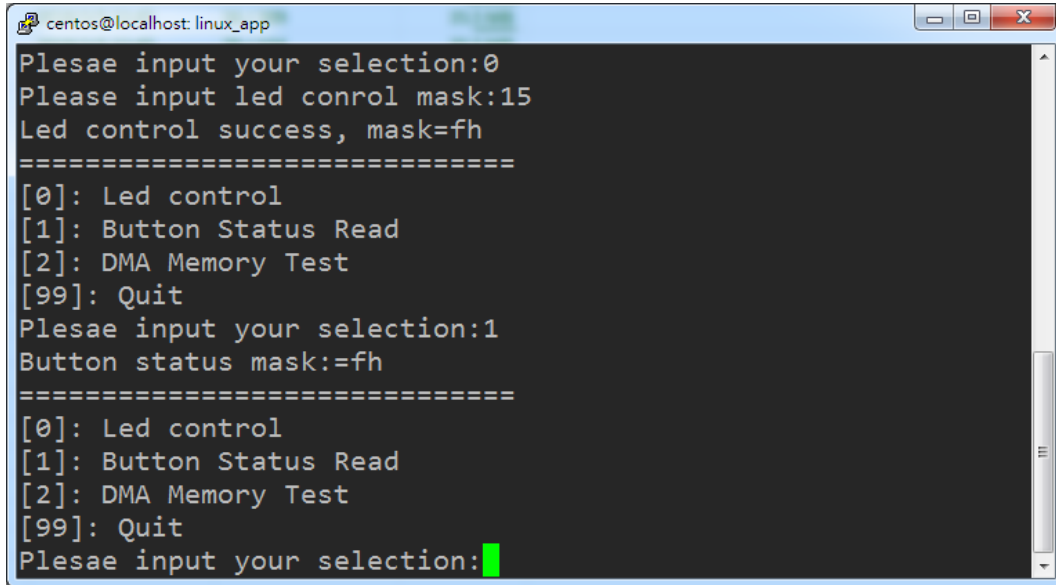

```
centos@localhost: linux_app
Plesae input your selection:0
Please input led conrol mask:15
Led control success, mask=fh
=====
[0]: Led control
[1]: Button Status Read
[2]: DMA Memory Test
[99]: Quit
Plesae input your selection:1
Button status mask:=fh
=====
[0]: Led control
[1]: Button Status Read
[2]: DMA Memory Test
[99]: Quit
Plesae input your selection:█
```

Figure 8-8 Button Status Report

11. Type 2 followed by the ENTER key to select the DMA Testing item. The DMA test result will be reported as shown in **Figure 8-9**.

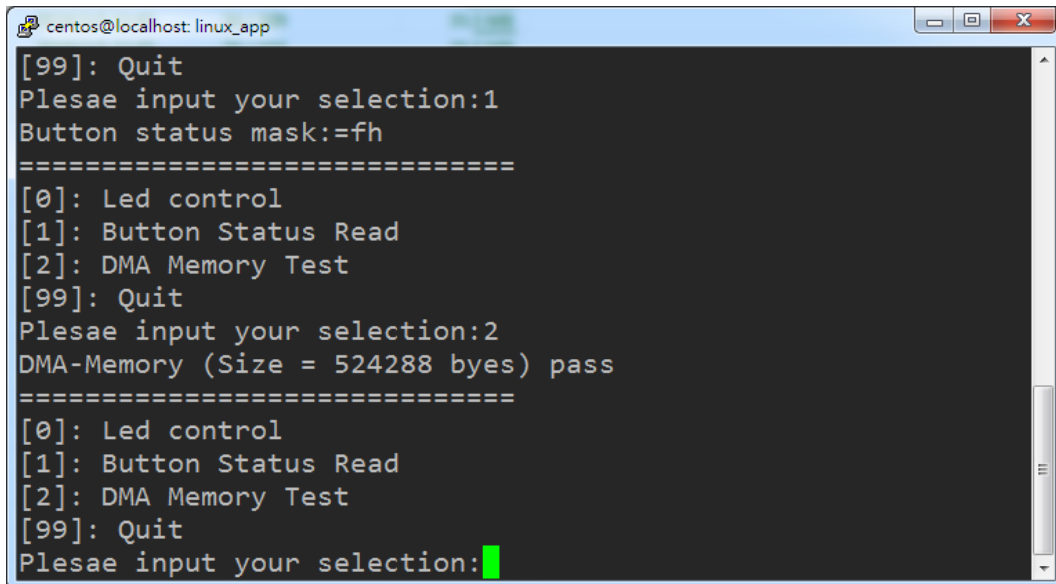

```
centos@localhost: linux_app
[99]: Quit
Plesae input your selection:1
Button status mask:=fh
=====
[0]: Led control
[1]: Button Status Read
[2]: DMA Memory Test
[99]: Quit
Plesae input your selection:2
DMA-Memory (Size = 524288 bytes) pass
=====
[0]: Led control
[1]: Button Status Read
[2]: DMA Memory Test
[99]: Quit
Plesae input your selection:█
```

Figure 8-9 DMA Memory Test Result

12. Type 99 followed by the ENTER key to exit this test program.

■ Development Tools

- Quartus Prime 17.1 Standard Edition
- GNU Compiler Collection, Version 4.8 is recommended

■ Demonstration Source Code Location

- Quartus Project: Demonstration/C5P_PCIE_Fundamental
- C++ Project: Demonstration/PCIE_SW_KIT/Linux/PCIE_FUNDAMENTAL

■ FPGA Application Design

Figure 8-10 shows the system block diagram in the FPGA system. In the Qsys, PIO controller is used to control the LED and monitor the Button Status, and the On-Chip Memory is used for performing DMA testing. The PIO controllers and the On-Chip Memory are connected to the PCIe Hard IP controller through the Avalon-MM Interface.

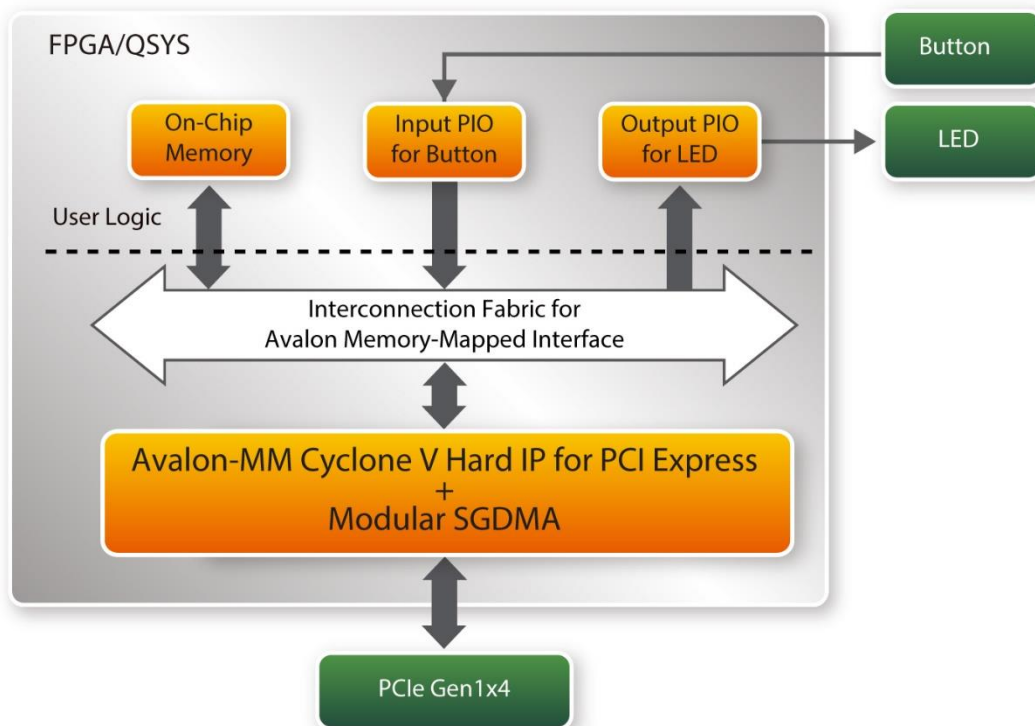

Figure 8-10 Hardware block diagram of the PCIe reference design

■ Linux Based Application Software Design

The application software project is built by the GNU Toolchain. The project includes the following major files:

Name	Description
PCIE_FUNDAMENTAL.cpp	Main Program
PCIE.c	Implement dynamically load for terasic_pcie_msgdma.so library file
PCIE.h	
TERASIC_PCIE_mSGDMA.h	SDK library file, defines constant and data structure

The main program PCIE_FUNDAMENTAL.cpp includes the header file "PCIE.h" and defines the controller address according to the FPGA design.

```
#include "PCIE.h"

#define DEMO_PCIE_USER_BAR          PCIE_BAR4
#define DEMO_PCIE_IO_LED_ADDR      0x4000010
#define DEMO_PCIE_IO_BUTTON_ADDR   0x4000020
#define DEMO_PCIE_MEM_ADDR         0x07000000

#define MEM_SIZE                    (512*1024) //512KB
```

Before accessing the FPGA through PCIe, the application first calls PCIE_Load to dynamically load the terasic_pcie_msgdma.so. Then, it calls PCIE_Open to open the PCIe driver. The constant DEFAULT_PCIE_VID and DEFAULT_PCIE_DID used in PCIE_Open are defined in TERASIC_PCIE_mSGDMA.h. If developer change the Vendor ID and Device ID and PCIe IP, they also need to change the ID value define in TERASIC_PCIE_mSGDMA.h. If the return value of PCIE_Open is zero, it means the driver cannot be accessed successfully. In this case, please make sure:

- The FPGA is configured with the associated bit-stream file and the host PC is rebooted.
- The PCI express driver is loaded successfully.

The LED control is implemented by calling **PCIE_Write32** API, as shown below:

```
bPass = PCIE_Write32(hPCIE, DEMO_PCIE_USER_BAR, DEMO_PCIE_IO_LED_ADDR, (uint32_t) Mask);
```

The button status query is implemented by calling the **PCIE_Read32** API, as shown below:

```
PCIE_Read32(hPCIE, DEMO_PCIE_USER_BAR, DEMO_PCIE_IO_BUTTON_ADDR, &Status);
```

The memory-mapped memory read and write test is implemented by **PCIE_DmaWrite** and **PCIE_DmaRead** API, as shown below:

```
PCIE_DmaWrite(hPCIE, LocalAddr, pWrite, nTestSize);  
PCIE_DmaRead(hPCIE, LocalAddr, pRead, nTestSize);
```

8.6 PCIe Reference Design - DDR3

The application reference design shows how to add DDR3 Memory Controllers into the PCIe Quartus project based on the PCIe_Fundamental Quartus project and perform DMA data transmission. Also, this demo shows how to call “PCIE_ConfigRead32” API to check PCIe link status.

■ Demonstration Files

The demo file is located in the batch folder: CDRM/Demonstration/C5P_PcIe_DD R3/demo_batch

The folder includes following files:

- FPGA Configuration File: C5P_PcIe_DDR3.sof
- Download Batch file: test.sh
- Linux Application Software folder: linux_app, includes
 - PCIE_DDR3
 - terasic_pcie_msgdma.so

■ Demonstration Setup

1. Install the FPGA board on your PC.
2. Open a terminal and use "cd" command to goto “CDROM/Demonstration/C5P_PcIe_DDR3/demo_batch”.
3. Set QUARTUS_ROOTDIR variable pointing to the Quartus installation path. Set QUARTUS_ROOTDIR variable by typing the following commands in the terminal. Replace /home/centos/intelFPGA/17.1/quartus/ to your Quartus installation path.

```
export QUARTUS_ROOTDIR=/home/centos/intelFPGA/17.1/quartus/
```

4. Execute "sudo -E sh test.sh" command to configure the FPGA.
5. Restart Linux.
6. Install PCIe driver
7. Goto linux_app folder, execute PCIE_DDR3. A menu will appear as shown in **Figure 8-11**.

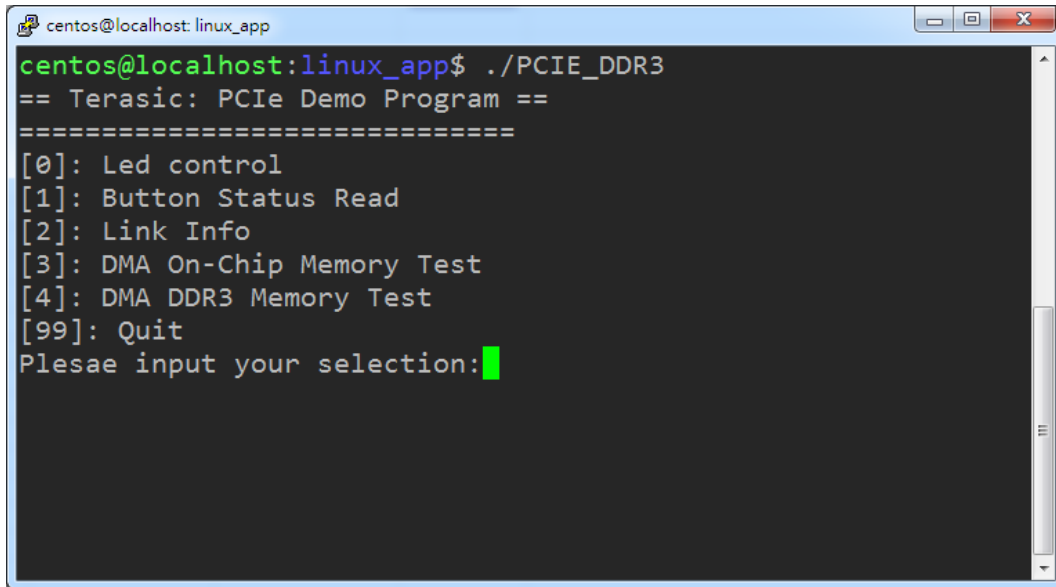

```
centos@localhost: linux_app
centos@localhost:linux_app$ ./PCIE_DDR3
== Terasic: PCIe Demo Program ==
=====
[0]: Led control
[1]: Button Status Read
[2]: Link Info
[3]: DMA On-Chip Memory Test
[4]: DMA DDR3 Memory Test
[99]: Quit
Plesae input your selection:█
```

Figure 8-11 Program Menu

8. Type 2 followed by the ENTER key to select Link Info item. The PCIe link information will be shown as in **Figure 8-12**.

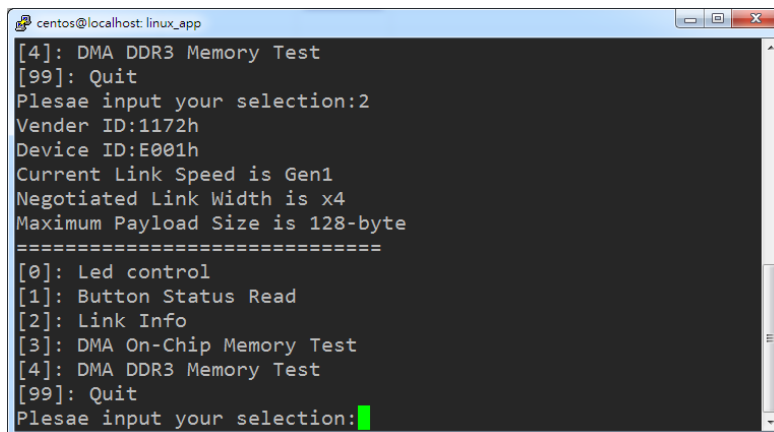

```
centos@localhost: linux_app
[4]: DMA DDR3 Memory Test
[99]: Quit
Plesae input your selection:2
Vender ID:1172h
Device ID:E001h
Current Link Speed is Gen1
Negotiated Link Width is x4
Maximum Payload Size is 128-byte
=====
[0]: Led control
[1]: Button Status Read
[2]: Link Info
[3]: DMA On-Chip Memory Test
[4]: DMA DDR3 Memory Test
[99]: Quit
Plesae input your selection:█
```

Figure 8-12 Link Information

9. Type 3 followed by the ENTER key to select the DMA On-Chip Memory Test item. The DMA write and read test result will be report as shown in **Figure 8-13**.

```

centos@localhost: linux_app
[99]: Quit
Plesae input your selection:3
DMA Memory Test, Address = 0x7000000, Size = 0x80000 Bytes...
Generate Test Pattern...
DMA Write...
DMA Read...
Readback Data Verify...
DMA-Memory Address = 0x7000000, Size = 0x80000 bytes pass
=====
[0]: Led control
[1]: Button Status Read
[2]: Link Info
[3]: DMA On-Chip Memory Test
[4]: DMA DDR3 Memory Test
[99]: Quit
Plesae input your selection:█

```

Figure 8-13 On-Chip Memory DMA Test Result

10. Type 4 followed by the ENTER key to select the DMA DDR Memory Test item. The DMA write and read test result will be report as shown in **Figure 8-14**.

```

centos@localhost: linux_app
Plesae input your selection:4
DMA Memory Test, Address = 0x40000000, Size = 0x40000000 Byte
s...
Generate Test Pattern...
DMA Write...
DMA Read...
Readback Data Verify...
DMA-Memory Address = 0x40000000, Size = 0x40000000 bytes pass
=====
[0]: Led control
[1]: Button Status Read
[2]: Link Info
[3]: DMA On-Chip Memory Test
[4]: DMA DDR3 Memory Test
[99]: Quit
Plesae input your selection:█

```

Figure 8-14 DDR3 Memory DMA Test Result

11. Type 99 followed by the ENTER key to exit this test program.

■ Development Tools

- Quartus Prime 17.1 Standard Edition
- GNU Compiler Collection, Version 4.8 is recommended

■ Demonstration Source Code Location

- Quartus Project: Demonstration/C5P_PCIE_DDR3
- C++ Project: Demonstration/PCIE_SW_KIT/Linux/PCIE_DDR3

■ FPGA Application Design

Figure 8-15 shows the system block diagram in the FPGA system. In the Qsys, PIO controller is used to control the LED and monitor the Button Status, and the On-Chip memory and DDR3 are used for performing DMA testing. The PIO controllers and the On-Chip Memory and DDR3 are connected to the PCIe Hard IP controller through the Avalon-MM Interface.

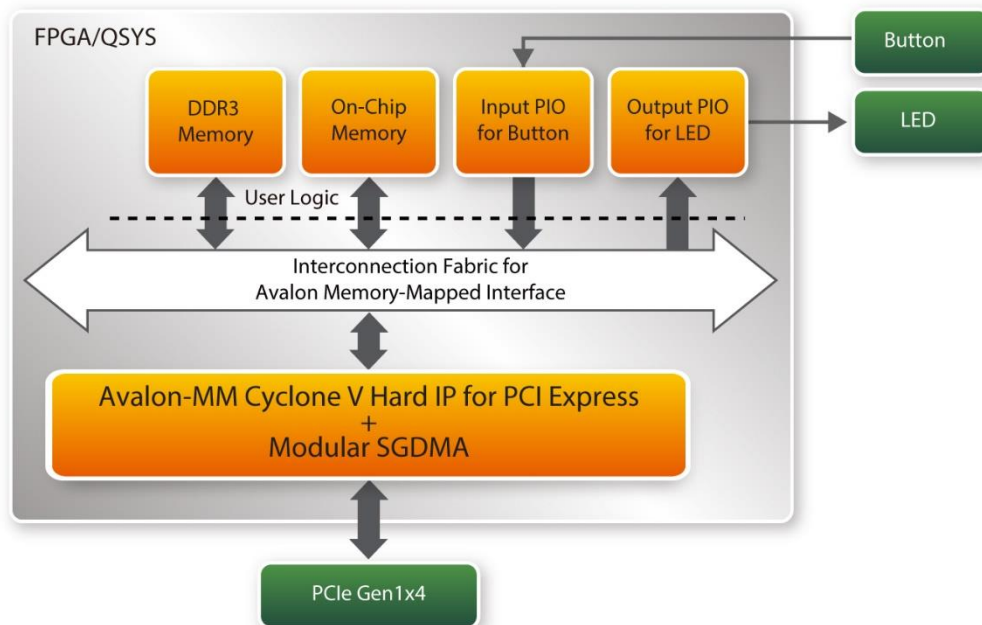

Figure 8-15 Hardware block diagram of the PCIe_DDR3 reference design

■ Linux Based Application Software Design

The application software project is built by the GNU Toolchain. The project includes the following major files:

Name	Description
PCIE_DDR3.cpp	Main program
PCIE.c	Implement dynamically load for terasic_pcie_qsys.so
PCIE.h	library file

TERASIC_PCIE_mSGDMA.h	SDK library file, defines constant and data structure
-----------------------	---

The main program PCIE_DDR3.cpp includes the header file PCIE.h and defines the controller address according to the FPGA design.

```
#define DEMO_PCIE_USER_BAR          PCIE_BAR4
#define DEMO_PCIE_IO_LED_ADDR       0x4000010
#define DEMO_PCIE_IO_BUTTON_ADDR    0x4000020
#define DEMO_PCIE_ONCHIP_MEM_ADDR   0x07000000
#define DEMO_PCIE_DDR3_MEM_ADDR     0x40000000

#define ONCHIP_MEM_TEST_SIZE        (512*1024) //512KB
#define DDR3_MEM_TEST_SIZE          (1*1024*1024*1024) //1GB
#define DMA_CHUNK_SIZE              (1*1024*1024*1024) //1GB
```

The above definition is the same as those in PCIe Fundamental demo.

Before accessing the FPGA through the PCIe, the application first calls the PCIE_Load to dynamically load the terasic_pcie_msgdma.so. Then, it calls the PCIE_Open to open the PCIe driver. The constant DEFAULT_PCIE_VID and DEFAULT_PCIE_DID are defined in TERASIC_PCIE_mSGDMA.h. If developer change the Vendor ID and Device ID and PCIe IP, they also need to change the ID value define in TERASIC_PCIE_mSGDMA.h. If the return value of the PCIE_Open is zero, it means the driver cannot be accessed successfully. In this case, please make sure:

- The FPGA is configured with the associated bit-stream file and the host is rebooted.
- The PCI express driver is loaded successfully.

The LED control is implemented by calling PCIE_Write32 API, as shown below:

```
bPass = PCIE_Write32(hPCIE, DEMO_PCIE_USER_BAR, DEMO_PCIE_IO_LED_ADDR, (uint32_t) Mask);
```

The button status query is implemented by calling the **PCIE_Read32** API, as shown below:

```
PCIE_Read32(hPCIE, DEMO_PCIE_USER_BAR, DEMO_PCIE_IO_BUTTON_ADDR, &Status);
```

The memory-mapped memory read and write test is implemented via the **PCIE_DmaWrite** and the **PCIE_DmaRead** API, as shown below:

```
PCIE_DmaWrite(hPCIE, LocalAddr, pWrite, nTestSize);  
PCIE_DmaRead(hPCIE, LocalAddr, pRead, nTestSize);
```

The PCIe link information is implemented by PCIE_ConfigRead32 API, as shown below:

```
// read config - link status  
if (PCIE_ConfigRead32(hPCIE, 0x90, &Data32)){  
    switch((Data32 >> 16) & 0x0F){  
        case 1:  
            printf("Current Link Speed is Gen1\r\n");  
            break;  
        case 2:  
            printf("Current Link Speed is Gen2\r\n");  
            break;  
        case 3:  
            printf("Current Link Speed is Gen3\r\n");  
            break;  
        default:  
            printf("Current Link Speed is Unknown\r\n");  
            break;  
    }  
    switch((Data32 >> 20) & 0x3F){  
        case 1:  
            printf("Negotiated Link Width is x1\r\n");  
            break;  
        case 2:  
            printf("Negotiated Link Width is x2\r\n");  
            break;  
        case 4:  
            printf("Negotiated Link Width is x4\r\n");  
            break;  
        case 8:  
            printf("Negotiated Link Width is x8\r\n");  
            break;  
        case 16:  
            printf("Negotiated Link Width is x16\r\n");  
            break;  
        default:  
            printf("Negotiated Link Width is Unknown\r\n");  
            break;  
    }  
}else{  
    bPass = false;  
}
```

Appendix

9.1 Revision History

Version	Changes Log
V1.0	Initial version
V1.1	Verify and modify the pin direction in Chapter 3

9.2 Copyright Statement

Copyright© 2018 Terasic Technologies Inc. All Rights Reserved.

Компания «Life Electronics» занимается поставками электронных компонентов импортного и отечественного производства от производителей и со складов крупных дистрибьюторов Европы, Америки и Азии.

С конца 2013 года компания активно расширяет линейку поставок компонентов по направлению коаксиальный кабель, кварцевые генераторы и конденсаторы (керамические, пленочные, электролитические), за счёт заключения дистрибьюторских договоров

Мы предлагаем:

- Конкурентоспособные цены и скидки постоянным клиентам.
- Специальные условия для постоянных клиентов.
- Подбор аналогов.
- Поставку компонентов в любых объемах, удовлетворяющих вашим потребностям.
- Приемлемые сроки поставки, возможна ускоренная поставка.
- Доставку товара в любую точку России и стран СНГ.
- Комплексную поставку.
- Работу по проектам и поставку образцов.
- Формирование склада под заказчика.
- Сертификаты соответствия на поставляемую продукцию (по желанию клиента).
- Тестирование поставляемой продукции.
- Поставку компонентов, требующих военную и космическую приемку.
- Входной контроль качества.
- Наличие сертификата ISO.

В составе нашей компании организован Конструкторский отдел, призванный помогать разработчикам, и инженерам.

Конструкторский отдел помогает осуществить:

- Регистрацию проекта у производителя компонентов.
- Техническую поддержку проекта.
- Защиту от снятия компонента с производства.
- Оценку стоимости проекта по компонентам.
- Изготовление тестовой платы монтаж и пусконаладочные работы.



Тел: +7 (812) 336 43 04 (многоканальный)

Email: org@lifeelectronics.ru