



12- and 14-Bit Hybrid Synchro/ Resolver-to-Digital Converters

SDC/RDC1740/1741/1742

FEATURES

- Internal Isolating Transformers
- Military Temperature Range
- Three Accuracy Options
- 14-Bit or 12-Bit Resolution
- High, Continuous Tracking Rate
- 32-Pin Welded Metal Package
- Hermetically Sealed
- Ratiometric Conversion
- Laser Trimmed - No External Adjustment
- Three-State Latched Outputs

APPLICATIONS

- Flight Instrumentation Systems
- Military Servo Control Systems
- Artillery Fire Control Systems
- Avionic Systems
- Antenna Monitoring
- Robotics
- Engine Controllers
- Coordinate Conversion
- Axis Transformation
- CNC Machine Tooling
- Process Control

GENERAL DESCRIPTION

The SDC/RDC1740/1741/1742 are hybrid 14- or 12-bit continuous tracking synchro or resolver to digital converters contained in 32-pin welded metal packages. In the core of this hybrid the conversion process is performed by a monolithic IC manufactured in Analog Devices proprietary BiMOS II process that combines the advantages of CMOS logic and bipolar high accuracy linear circuits on the same chip. Internal isolating micro-transformers are used to provide true isolation of the signal and reference inputs. The 14- or 12-bit digital word is in a three-state digital form available in two bytes. Using separate $\overline{\text{ENABLE}}$ inputs for the most significant 8 bits and the least significant 6 or 4 bits not only simplifies multiplexing of more than one device onto a single data bus, but also enables the $\overline{\text{INHIBIT}}$ input to be used without interrupting the operation of the tracking loop. The converters are hermetically sealed in a 32-pin welded metal package.

FUNCTIONAL BLOCK DIAGRAM

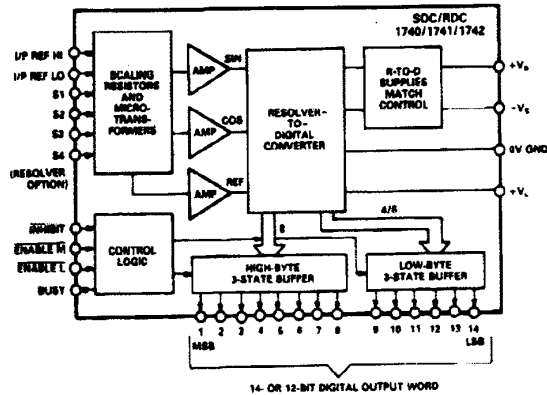

MODELS AVAILABLE

The three synchro/resolver-to-digital converters described in this data sheet differ primarily in the areas of resolution, accuracy and dynamic performance as follows:

Model SDC1740XYZ is a 14-bit converter with an overall accuracy of ± 5.3 arc minutes and a resolution of 1.3 arc minutes.

Model SDC1741XYZ is a 12-bit converter with an overall accuracy of ± 15.3 arc minutes and a resolution of 5.3 arc minutes.

Model SDC1742XYZ is a 12-bit converter with an overall accuracy of ± 8.5 arc minutes and a resolution of 5.3 arc minutes.

Each model has two operating temperature range versions, those covering the industrial temperature range (0 to +70°C) and the military temperature range (-55°C to +125°C). The XYZ code defines the option as follows: (X) signifies the operating temperature range, (Y) signifies the reference frequency, (Z) signifies the signal and reference voltage whether it will accept synchro or resolver format. To ensure a high level of reliability each converter receives stringent precap visual inspection, environmental screening and final electrical test.

Military temperature range devices and those processed to high reliability screening standards (suffix B) receive further levels of testing and screening to ensure high levels of reliability. More information about the option codes is given under the heading Ordering Information.

REV. A

Information furnished by Analog Devices is believed to be accurate and reliable. However, no responsibility is assumed by Analog Devices for its use; nor for any infringements of patents or other rights of third parties which may result from its use. No license is granted by implication or otherwise under any patent or patent rights of Analog Devices.

One Technology Way, P.O. Box 9106, Norwood, MA 02062-9106
Tel: 617/329-4700 Fax: 617/326-8703 Twx: 710/394-6577
West Coast Central Atlantic
714/641-9391 214/231-5094 215/643-7790

SDC/RDC1740/1741/1742—SPECIFICATIONS (typical at 25°C unless otherwise specified)

Parameter	SDC/RDC1740	SDC/RDC1741	SDC/RDC1742	Units	Comments	Notes
CONVERTER PERFORMANCE						
Accuracy	±5.3 max	±15.3 max	±8.5 max	arc min		1, 3
Tracking Rate	27 min	18 min	**	rev/s		4
Resolution	14 (1 LSB = 1.3 arc min)	12 (1 LSB = 5.3 arc min)	**	Bits	Output Coding Parallel Natural Binary	
Signal & Reference Frequency	400	*	*	Hz	Option X1Z	
	2.6	*	*	kHz	Option X4Z	
Repeatability of Position Output	1	*	*	LSB		4
Bandwidth	130	150	**	Hz		4
SIGNAL INPUT IMPEDANCE						
90V Signal	200	*	*	kΩ	Resistive Tolerance ±2%	4
26V Signal	57.7	*	*	kΩ		4
11.8V Signal	26	*	*	kΩ		4
REFERENCE INPUTS						
Reference Voltage	11.8, 26, 115	*	*	V rms	See Ordering Information	
Reference Impedance					Resistive Tolerance ±5%	
115V Ref	120	*	*	kΩ		4
26V Ref	27	*	*	kΩ		4
11.8V Ref	12.3	*	*	kΩ		4
ACCELERATION CONSTANT						
	56000	80000	**	sec ⁻²	Symbol K _a	4
LARGE STEP RESPONSE						
	85 typ 100 max	60 typ 75 max	** **	ms ms	179° Step for Settling to 1 LSB of Error	1, 3
POWER LINES						
+V _s = +15V	28 typ 35 max	*	*	mA	Quiescent Condition	1, 3
-V _s = -15V	28 typ 35 max	*	*	mA	Quiescent Condition	1, 3
V _L = +5V	35 typ 56 max	*	*	mA	Quiescent Condition	1, 3
Power Dissipation	1.4 max	*	*	W		
DIGITAL INPUTS (INHIBIT, ENABLE L, ENABLE M)						
V (Input High)	2 min	*	*	V dc	V _L = +5V	1, 3
V (Input Low)	0.7 max	*	*	V dc	V _L = +5V	1, 3
I (Input High)	20 max	*	*	μA	V _{IH} = 2.4V	1, 3
I (Input Low)	-400 max	*	*	μA	V _{IL} = 0.4V	1, 3
ENABLE AND DISABLE TIME						
	80 max	*	*	ns		2, 4
INHIBIT						
Sense	Logic Low to INHIBIT	*	*			
Time to Data Stable (after Negative-Going Edge of INHIBIT)	640 max	*	*	ns		4
BUSY OUTPUT						
Sense		Active Logic High when converter position output changing. Positive going edge 50ns before change in position output.				
Timing						
Width	400 typ 200 min 600 max	*	*	ns ns ns		4 4 4
Load	2 min	*	*	TTL		4
DIGITAL OUTPUTS						
Voltage Levels						
Logic High	2.4 min	*	*	V dc	V _L = +5V, I _{OH} = -240μA	1, 3
Logic Low	0.4 max	*	*	V dc	V _L = +5V I _{OL} = 9.6mA	1, 3
Load	6 max	*	*	TTL		

SDC/RDC1740/1741/1742

Parameter	SDC/RDC1740	SDC/RDC1741	SDC/RDC1742	Units	Comments	Notes
OPERATING TEMPERATURE RANGE						
Option 5YZ	0 to +70	*	*	°C		
Option 4YZ	-55 to +125	*	*	°C		
DIMENSIONS	1.74×1.14×0.28 (44.2×28.9×7.1)	*	*	Inch mm	See Package Information	4
WEIGHT	0.86 max 25 max	*	*	oz grams		4

NOTES

¹Specified over the appropriate operating temperature range and for: (a) ±10% signal and reference amplitude variation; (b) ±10% signal and reference harmonic distortion; (c) ±5% power supply variation; (d) ±10% variation in reference frequency.

²ENABLE M enables most significant 8 bits.

ENABLE L enables least significant 4 bits (or 6 bits for SDC/RDC1740).

³100% tested at nominal values of power supplies, input signal voltages and operating frequency.

⁴Guaranteed by design.

*Specifications same as SDC/RDC1740.

**Specifications same as SDC/RDC1741.

Specifications subject to change without notice.

ABSOLUTE MAXIMUM RATINGS

+V _S ¹ to GND	+17.25V dc
-V _S to GND	-17.25V dc
+V _L ² to GND	+7V dc
Reference Input HI to GND	±350V dc
Reference Input LO to GND	±350V dc
Common Mode Range	±175V rms
S1, S2, S3, S4 to GND	±350V dc
Any Logical Input to GND	-0.4V to +V _L

Case to GND	±20V dc
Storage Temperature Range	-65°C to +150°C

CAUTION:

¹Correct polarity voltages must be maintained on the +V_S and -V_S pins. The +5V power supply must never go below GND potential.

NOTE

Absolute maximum ratings are those values beyond which damage to the device may occur.

ORDERING INFORMATION

For full definition, the converter part number should be suffixed by an option code. All the standard options and their option codes are shown below. For options not shown, please consult Analog Devices.

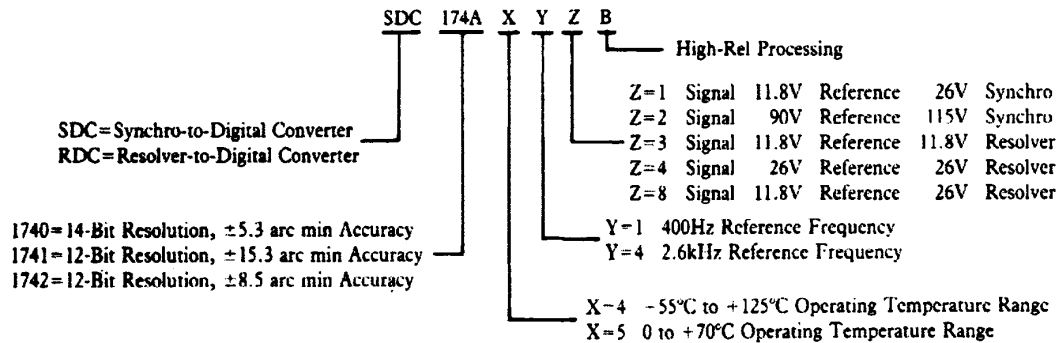

SDC/RDC1740/1741/1742

PIN CONFIGURATION



NOTE 1: FOR THE RESOLVER OPTION PIN 17 IS S4.
FOR THE SYNCHRO OPTION PIN 17 IS NOT CONNECTED.

NOTE 2: FOR THE 1741 AND 1742 PINS 13 AND 14 ARE NOT CONNECTED.

Bit Number	Weight in Degrees
1 (MSB)	180.0000
2	90.0000
3	45.0000
4	22.5000
5	11.2500
6	5.6250
7	2.8125
8	1.4063
9	0.7031
10	0.3516
11	0.1758
12 (LSB for 1741/1742)	0.0879
13	0.0439
14 (LSB for 1740)	0.0220

Table 1. Bit Weight Table

PIN FUNCTION DESCRIPTION

Pin	Maemonic	Description
1-14	Bit 1-14 (1740)	Parallel output data bits.
1-12	Bit 1-12 (1741/1742)	
15	REF LO	Input pins for the reference signal.
16	REF HI	
17	S4 OR N/C	S4 signal input for Resolver option. N/C for Synchro option.
18	S3	Synchro/Resolver input signals.
19	S2	
20	S1	
21	N/C	No Connection.
22	N/C	No Connection.
23	CASE	Should be connected to 0V GND.
24	N/C	No Connection.
25	ENABLE L	ENABLE L enables the 6 or 4 least significant bits.
26	ENABLE M	ENABLE M enables the 8 most significant bits. Logic High sets the output data bits to a high impedance state; a Logic Low presents the data in the latches to the output pins.
27	BUSY	Converter busy. A Logic High output indicates that the output latches are being updated and data should not be transferred.
28	INHIBIT	Logic Low inhibits the data transfer from the counter to the output latches.
29	+V _S	Main positive power supply.
30	0V GND	Power supply ground.
31	-V _S	Main negative power supply.
32	+V _L	Logic power supply.

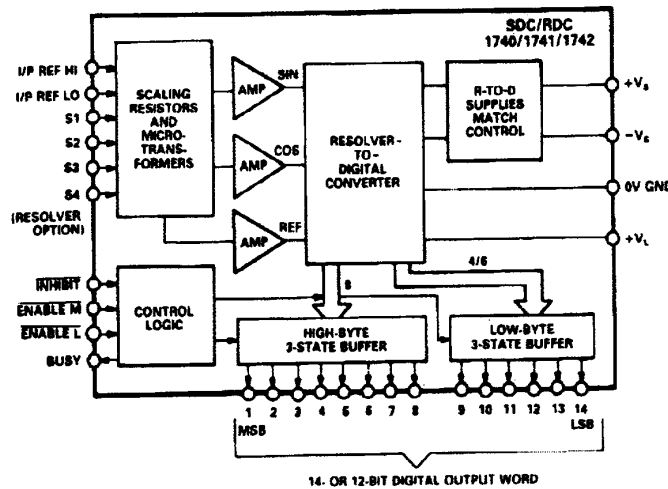

Figure 1. Functional Diagram of the SDC/RDC1740/1741/1742

THEORY OF OPERATION

In the synchro-to-digital converter configuration, the 3-wire synchro output should be connected to S1, S2 and S3 on the unit and the Scott T transformer pair will convert these signals into resolver format, i.e.,

$$V_1 = K E_O \sin \omega t \sin \theta \quad (\text{SIN})$$

$$V_2 = K E_O \sin \omega t \cos \theta \quad (\text{COS})$$

where θ is the angle of the synchro shaft.

In the resolver-to-digital converter configuration, the 4-wire resolver output should be connected to S1, S2, S3 and S4 on the unit and the transformers will act purely as isolators.

To understand the conversion process, then assume that the current word state of the up-down counter is ϕ .

V_1 is multiplied by $\text{COS}\phi$ and V_2 is multiplied by $\text{SIN}\phi$ to give:

$$K E_O \sin \omega t \sin \theta \cos \phi$$

$$\text{and } K E_O \sin \omega t \cos \theta \sin \phi.$$

These signals are subtracted by the error amplifier to give:

$$K E_O \sin \omega t (\sin \theta \cos \phi - \cos \theta \sin \phi)$$

$$\text{or } K E_O \sin \omega t \sin (\theta - \phi).$$

A phase sensitive detector, integrator and voltage controlled oscillator (VCO) form a closed loop system which seeks to null $\sin (\theta - \phi)$. The digital output (counter ϕ), then represents the synchro/resolver shaft angle θ within the specified accuracy of the converter.

INHIBIT INPUT

The INHIBIT logic input only inhibits the data transfer from the up-down counter to the output latches and, therefore, does not interrupt the operation of the tracking loop. Releasing the INHIBIT automatically generates a busy pulse to refresh the output data.

ENABLE INPUTS

The ENABLE inputs determine the state of the output data. A Logic High maintains the output data pins in the high impedance condition, and application of a Logic Low presents the data in the latches to the output pins. ENABLE M enables the most significant 8 bits, while ENABLE L, enables the least significant 4 bits (6 bits in the SDC/RDC1740). The operation of the ENABLE inputs has no effect on the conversion process.

DATA TRANSFER

Data transfer can be accomplished using either the INHIBIT input or the trailing edge, positive to negative transition of the BUSY pulse output.

The data will be valid 640ns after the application of a Logic Lo to the INHIBIT input. This is regardless of the time when the INHIBIT is applied and allows time for an active busy pulse to clear. By using the ENABLE M and ENABLE L inputs the two bytes of data can be transferred after which the INHIBIT should be returned to a Logic Hi state to enable the output latches to be updated.

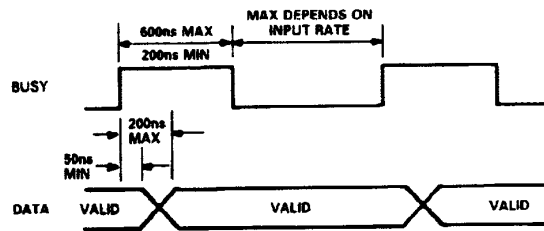

Figure 2. Timing Diagram

SDC/RDC1740/1741/1742

BUSY OUTPUT

The validity of the output data is indicated by the state of the BUSY output. When the input to the converter is changing, the signal appearing on the BUSY output is a series of pulses at TTL levels. A BUSY is initiated each time the input moves by an analog equivalent of an LSB and the internal counter is incremented or decremented or the INHIBIT input is released.

Typically the width of the BUSY pulse is 400ns during the position data output updates. The trailing edge, positive to negative transition, of the BUSY pulse indicates that the position data output has been updated and is ready for transfer (data valid). The maximum load on the BUSY output using the trailing edge of the BUSY pulse is 2 TTL loads.

CONNECTING THE CONVERTER

The power supply voltages connected to +V_s and -V_s pins should be ±15V and must not be reversed. The digital logic supply V_L is connected to +5V.

It is suggested that a parallel combination of a 0.1μF ceramic and a 6.8μF electrolytic capacitor is placed from each of the three supply pins to GND.

The pin marked CASE is connected electrically to the case and should be taken to a convenient zero volt potential in the system.

The digital output is taken from Pin 1 through to Pin 12 for the SDC/RDC1741/1742 and Pin 1 through to Pin 14 for the SDC/RDC1740 where Pin 1 is the MSB.

The reference connections are made to REF HI and REF LO. In the case of a synchro, the signals are connected to S1, S2 and S3 according to the following convention:

$$E_{S1-S3} = E_{RLO-RHI} \sin \omega t \sin \theta$$

$$E_{S3-S2} = E_{RLO-RHI} \sin \omega t \sin (\theta + 120^\circ)$$

$$E_{S2-S1} = E_{RLO-RHI} \sin \omega t \sin (\theta + 240^\circ)$$

For a resolver, the signals are connected to S1, S2, S3 and S4 according to the following convention:

$$E_{S1-S3} = E_{RLO-RHI} \sin \omega t \sin \theta$$

$$E_{S2-S4} = E_{RHI-RLO} \sin \omega t \cos \theta$$

The BUSY, INHIBIT and ENABLE pins should be connected as described under the heading Data Transfer.

RESISTIVE SCALING OF INPUTS

A feature of these converters is that the signal and reference inputs can be resistively scaled to accommodate any change of input signal and reference voltages.

This means that a standard converter can be used with a personality card in systems where a wide range of input and reference voltages are encountered.

Note: The accuracy of the converter will be affected by the matching accuracies of resistors used for external scaling.

To calculate the values of the external scaling resistors in the case of a synchro converter, add 1.11kΩ per extra volt of signal in series with S1, S2 and S3 and 1kΩ per extra volt of reference in series with RHI. In the case of a resolver-to-digital converter, add 2.22kΩ in series with S1 and S2 per extra volt of signal and 1kΩ per extra volt of reference in series with RHI.

DYNAMIC PERFORMANCE

The transfer function of the converter is given below.

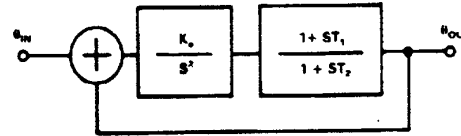

Figure 3. Transfer Function of SDC/RDC1740/1741/1742

Open loop gain:

$$\frac{\theta_{OUT}}{\theta_{IN}} = \frac{K_a}{s^2} \cdot \frac{1 + sT_1}{1 + sT_2}$$

Closed loop gain:

$$\frac{\theta_{OUT}}{\theta_{IN}} = \frac{1 + sT_1}{1 + sT_1 + \frac{s^2}{K_a} + \frac{s^2 T_2}{K_a}}$$

Model SDC/RDC1740

Where K_a = 56,000

T₁ = 0.01

T₂ = 0.001525

The gain and phase diagrams are shown in Figures 4 and 5.

Model SDC/RDC1741/1742

Where K_a = 80,000

T₁ = 0.0087

T₂ = 0.001569

The gain and phase diagrams are shown in Figures 6 and 7.

ACCELERATION ERROR

A tracking converter employing a type 2 servo loop does not suffer any velocity lag, however, there is an additional error due to acceleration. This additional error can be defined using the acceleration constant K_a of the converter.

$$K_a = \frac{\text{Input Acceleration}}{\text{Error in Output Angle}}$$

The numerator and denominator have the same units. K_a does not define maximum acceleration, only the error due to acceleration, maximum acceleration is in the region of 5 times the K_a figure. The following is an example using the K_a of the SDC1740.

Acceleration of 50 revolutions sec⁻² with K_a = 56000

$$\text{Error in LSBs} = \frac{50 \times 16384}{56000} = 14.62 \text{ LSBs}$$

SDC/RDC1740/1741/1742



Figure 4. SDC/RDC1740 Gain Plot



Figure 6. SDC/RDC1741/1742 Gain Plot

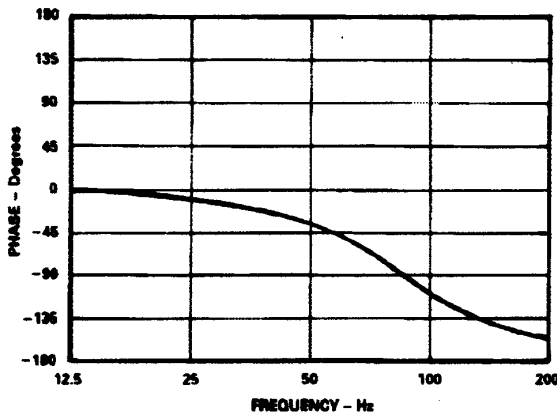

Figure 5. SDC/RDC1740 Phase Plot

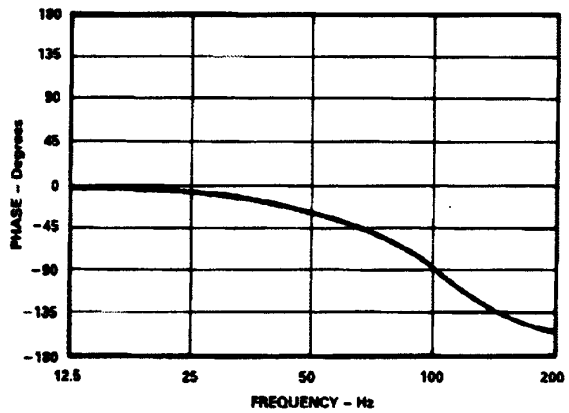

Figure 7. SDC/RDC1741/1742 Phase Plot

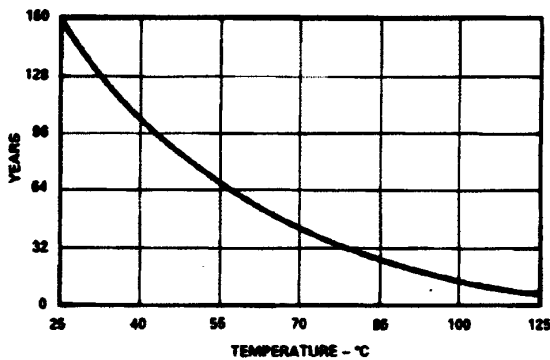

Figure 8. SDC/RDC1740/41/42 MTBF Curve

RELIABILITY

The reliability of these products is very high due to the extensive use of custom chip circuits that decrease the active component count. Calculations of the MTBF figure under various environmental conditions are available on request.

As an example of the Mean Time Between Failures (MTBF) calculated according to MIL-HDBK-217E, Figure 8 shows the MTBF in years versus case temperature in naval sheltered conditions for SDC/RDC1740/41/42.

SDC/RDC1740/1741/1742

OTHER PRODUCTS

Many other hybrid products concerned with the conversion of synchro data are manufactured by Analog Devices, some of which are listed below. If you have any questions about our products or require advice about their use for a particular application, please contact our Applications Engineering Department.

The *SDC/RDC1767* and *SDC/RDC1768* are hybrid synchro-to-digital converters with isolating microtransformers similar to the *SDC/RDC1740/41/42* described on this data sheet with the additional features of analog velocity output and dc error output.

The *OSC1758* is a hybrid sine/cosine power oscillator which can provide a maximum power output of 1.5 watts, over a frequency range of 0 to 10kHz.

The *DRC1745* and *DRC1746* are 14- and 16-bit natural binary latched output hybrid digital-to-resolver converters. The accuracies available are ± 2 and ± 4 arc mins, and the outputs can supply 2VA at 7V rms.

OUTLINE DIMENSIONS

Dimensions shown in inches and (mm).

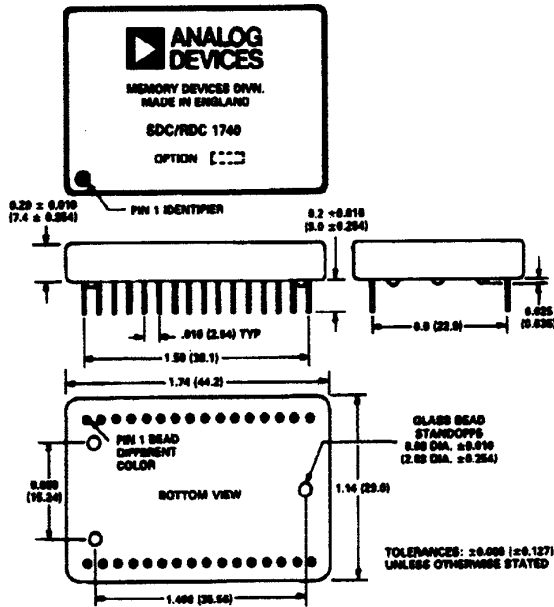

Компания «Life Electronics» занимается поставками электронных компонентов импортного и отечественного производства от производителей и со складов крупных дистрибьюторов Европы, Америки и Азии.

С конца 2013 года компания активно расширяет линейку поставок компонентов по направлению коаксиальный кабель, кварцевые генераторы и конденсаторы (керамические, пленочные, электролитические), за счёт заключения дистрибьюторских договоров

Мы предлагаем:

- Конкурентоспособные цены и скидки постоянным клиентам.
- Специальные условия для постоянных клиентов.
- Подбор аналогов.
- Поставку компонентов в любых объемах, удовлетворяющих вашим потребностям.
- Приемлемые сроки поставки, возможна ускоренная поставка.
- Доставку товара в любую точку России и стран СНГ.
- Комплексную поставку.
- Работу по проектам и поставку образцов.
- Формирование склада под заказчика.
- Сертификаты соответствия на поставляемую продукцию (по желанию клиента).
- Тестирование поставляемой продукции.
- Поставку компонентов, требующих военную и космическую приемку.
- Входной контроль качества.
- Наличие сертификата ISO.

В составе нашей компании организован Конструкторский отдел, призванный помогать разработчикам, и инженерам.

Конструкторский отдел помогает осуществить:

- Регистрацию проекта у производителя компонентов.
- Техническую поддержку проекта.
- Защиту от снятия компонента с производства.
- Оценку стоимости проекта по компонентам.
- Изготовление тестовой платы монтаж и пусконаладочные работы.



Тел: +7 (812) 336 43 04 (многоканальный)
Email: org@lifeelectronics.ru