

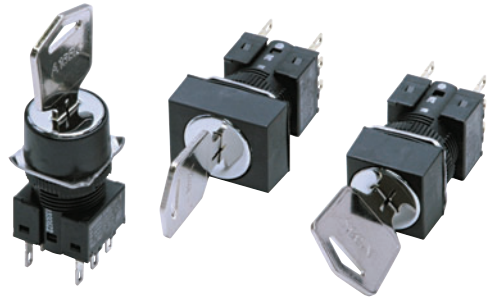

A165K

Separate Construction with Cylindrical 16-dia. Body

- Short mounting depth, less than 28.5 mm below panel
- Wide range of switching capacity from standard to microload
- Oil-resistant IP65 models



 Refer to *Safety Precautions for All Pushbutton Switches and Safety Precautions* on page 11.

List of Models

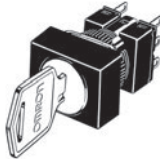
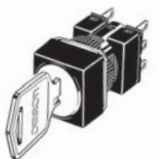
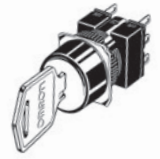
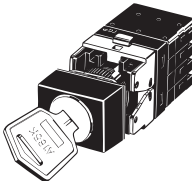
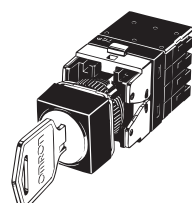
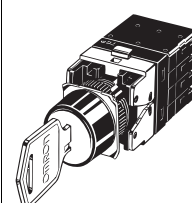
	Model		
	Rectangular	Square	Round
Solder terminals	 <p>A165K-J Series</p>	 <p>A165K-A Series</p>	 <p>A165K-T Series</p>
Screwless clamp connector	 <p>A165K-J Series</p>	 <p>A165K-A Series</p>	 <p>A165K-T Series</p>

Model Number Structure

Model Number Legend The model numbers used to order sets of Units are illustrated below. One set comprises the Selector, Switch, and 2 Keys.
For information on combinations, refer to *Ordering Information* on page 3.

(1) (2) (3)
A 1 6 5 K - J 3 M L - 2

(1) Shape of Selector

Symbol	Shape	Color
J	Rectangular	Black
A	Square	
T	Round	

(2) Number of Notches/Resetting Method

Symbol	No. of notches	Reset method	Key release position
2ML	2 notches	Manual	Left
2MR			Right
2M			Left and right
2AL		Automatic	Left
3MC	3 notches	Manual	Center
3MR			Right
3ML			Left
3M		Left, right, and center	
3AC	3 notches	Automatic	Center

(3) Contact Configuration

Symbol	Type	Terminal
1	SPDT	Solder Terminal
2	DPDT	
2S	DPDT	Screw-less Clamp

Note: Only DPDT contacts are available with 3-notch models.

Ordering Information

Ordering as a Set The model numbers used to order sets of Units are given in the following tables. One set comprises the Selector, Switch and 2 Keys.

Solder Terminals

Rectangular Models



Oil-resistant IP65

Number of notches	Output	Reset method	Key release position	Model
2 notches	SPDT	Manual	Left	A165K-J2ML-1
			Right	A165K-J2MR-1
			Left and right	A165K-J2M-1
	DPDT	Automatic	Left	A165K-J2AL-1
			Right	A165K-J2ML-2
			Left and right	A165K-J2MR-2
3 notches	DPDT	Manual	Center	A165K-J3MC-2
			Right	A165K-J3MR-2
			Left	A165K-J3ML-2
			Left, right, and center	A165K-J3M-2

Square Models



Oil-resistant IP65

Number of notches	Output	Reset method	Key release position	Model
2 notches	SPDT	Manual	Left	A165K-A2ML-1
			Right	A165K-A2MR-1
			Left and right	A165K-A2M-1
	DPDT	Automatic	Left	A165K-A2AL-1
			Right	A165K-A2ML-2
			Left and right	A165K-A2MR-2
3 notches	DPDT	Manual	Center	A165K-A3MC-2
			Right	A165K-A3MR-2
			Left	A165K-A3ML-2
			Left, right, and center	A165K-A3M-2

Round Models





Oil-resistant IP65

Number of notches	Output	Reset method	Key release position	Model
2 notches	SPDT	Manual	Left	A165K-T2ML-1
			Right	A165K-T2MR-1
			Left and right	A165K-T2M-1
	DPDT	Automatic	Left	A165K-T2AL-1
			Right	A165K-T2ML-2
			Left and right	A165K-T2MR-2
3 notches	DPDT	Manual	Center	A165K-T3MC-2
			Right	A165K-T3MR-2
			Left	A165K-T3ML-2
			Left, right, and center	A165K-T3M-2

Ordering Information

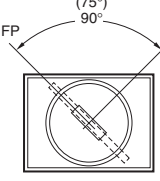
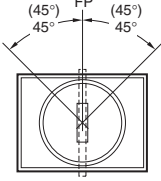

Ordering Individually Selectors and Switches can be ordered separately. Combinations that are not available as sets can be created using individual Units. Also, store the parts as spares for maintenance and repairs.

Operation Units (Listed on Page 5.)

<p>Rectangular (A165K-J)</p>  <p>Two keys are provided.</p>	<p>Square (A165K-A)</p> 	<p>Round (A165K-T)</p> 	<p>(Standard condition when shipped)</p> <div style="display: flex; justify-content: space-around;"> <div style="text-align: center;"> <p>Switches with 2 Notches</p> <p>(75°) 90°</p>  </div> <div style="text-align: center;"> <p>Switches with 3 Notches</p> <p>(45°) FP (45°) 45°</p>  </div> </div> <p>Note: The figures in parentheses are for self-resetting models. FP: Free position</p>
--	---	--	---



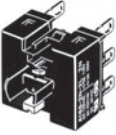
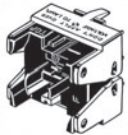

Socket Units (Listed on Page 5.)

<p>Solder terminals</p> 	<p>PCB terminals</p> 	<p>Screw-less clamp connector</p> 
--	---	--



Ordering Information

Ordering Individually Selectors and Switches can be ordered separately. Combinations that are not available as sets can be created using individual Units. Also, store the parts as spares for maintenance and repairs.

Selectors

Appearance	Number of notches	Reset method	Key release position	Model
Rectangular (A165K-J) 	2 notches	Manual	⊘	A165K-J2ML
			⊘	A165K-J2MR
		Automatic	⊘	A165K-J2M
			⊘	A165K-J2AL
	3 notches	Manual	⊘	A165K-J3MC
			⊘	A165K-J3MR
		Automatic	⊘	A165K-J3ML
			⊘	A165K-J3M
Square (A165K-A) 	2 notches	Manual	⊘	A165K-A2ML
			⊘	A165K-A2MR
		Automatic	⊘	A165K-A2M
			⊘	A165K-A2AL
	3 notches	Manual	⊘	A165K-A3MC
			⊘	A165K-A3MR
		Automatic	⊘	A165K-A3ML
			⊘	A165K-A3M
Round (A165K-T) 	2 notches	Manual	⊘	A165K-T2ML
			⊘	A165K-T2MR
		Automatic	⊘	A165K-T2M
			⊘	A165K-T2AL
	3 notches	Manual	⊘	A165K-T3MC
			⊘	A165K-T3MR
		Automatic	⊘	A165K-T3ML
			⊘	A165K-T3M
	Automatic	⊘	A165K-T3AC	

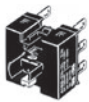
Switches

Appearance	Classification			Model	
	Switch	2 notches	SPDT	Solder terminal	A16S-2N-1
			DPDT		A16S-2N-2
		3 notches	DPDT	A16S-3N-2	
		2 notches	SPDT	PCB terminal	A16S-2N-1P
			DPDT		A16S-2N-2P

Switches with Screw-less Clamp

Appearance	Classification			Model	Remarks	
	Common to standard load and microload.	DPDT	2 notches	Non-lighted	A16-2S	Common to ones for pushbutton switches.
			3 notches		A16S-3N-2LS	



Ordering Information

Accessories and Tools (Order Separately)

Accessories

Name	Appearance	Classification	Model	Remarks
Panel Plugs		Rectangular	A16ZJ-3003	Used for covering the panel cutouts for future panel expansion. Degree of protection: IP40 Color: Black
		Square	A16ZA-3003	
		Round	A16ZT-3003	

Tools

Name	Appearance	Model	Applicable types					Remarks
			Pushbutton Switch	Knob-type Selector Switch	Key-type Selector Switch	Emergency Stop Switch	Indicator	
Screw Fitting		A16Z-3004	Yes	Yes	Yes	Yes	Yes	Convenient for ganged installation.
Extractor		A16Z-5080	Yes	Yes	Yes	Yes	Yes	Convenient for extracting the Lamp from a Solder-terminal Socket Unit.

Key

Appearance	Model
	A165K-KEY

Note: Two Keys are provided.

Ordering as a Set: Refer to page 3.

- Specifications, and dimensions: Refer to page 7 to 10.
- Accessories, replacements, and tools: Refer to this page.

Specifications

Approved Standard Ratings

UL, cUL (File No. E41515)

5 A at 125 VAC, 3 A at 250 VAC (general use)
3 A at 30 VDC (resistive)

Note: Certification has been obtained for the Switch Unit.
For detailed information on individual products that have received certification, consult your supplier.

TÜV (EN60947-5-1) (Low Voltage Directive)

3 A at 250 VAC
3 A at 30 VDC

CCC (GB14048.5)

5 A at 125 VAC
3 A at 250 VAC
3 A at 30 VDC

Ratings

Contacts

Rated voltage	Resistive load
125 VAC	5 A
250 VAC	3 A
30 VDC	3 A

Minimum applicable load: 1 mA at 5 VDC

Rated values are obtained from tests conducted under the following conditions.

1. Load: Resistive load
2. Mounting conditions: No vibration and no shock
3. Temperature: 20±2°C
4. Operating frequency: 20 times/min

Contact Form

Name	Contact form
SPDT	

Characteristics

Socket Units

Item	Type	Key-type Selector Switch
Allowable operating frequency	Mechanical	20 operations/minute max.
	Electrical	10 operations/minute max.
Insulation resistance		100 MΩ min. (at 500 VDC)
Dielectric strength	Between terminals of same polarity	1,000 VAC, 50/60 Hz for 1 minute
	Between terminals of different polarity	2,000 VAC, 50/60 Hz for 1 minute
	Between each terminal and ground	2,000 VAC, 50/60 Hz for 1 minute
Vibration resistance	Malfunction	10 to 55 Hz, 1.5-mm double amplitude (malfunction within 1 ms)
Shock resistance	Destruction	500 m/s ²
	Malfunction	150 m/s ² max. (malfunction within 1 ms)
Durability	Mechanical	250,000 operations min. (durability of key: 10,000 operations min.)
	Electrical	100,000 operations min.
Electric shock protection class		Class II
PTI (tracking characteristic)		175
Degree of contamination		3 (IEC60947-5-1)
Weight		Approx. 26.5 g (in the case of a DPDT switch key)
Ambient operating temperature		-10°C to 55°C (with no icing or condensation)
Ambient operating humidity		35% to 85%RH
Ambient storage temperature		-25°C to 65°C (with no icing or condensation)

Screw-less Clamp

Item	Type	Screw-less Clamp			
Recommended wire size		0.5 mm ² twisted wire or 0.8 mm-dia. solid wire			
Usable wires and tensile strength	Twisted wire	0.3 mm ²	0.5 mm ²	0.75 mm ²	1.25 mm ²
	Solid wire	0.5 mm dia.	0.8 mm dia.	1.0 mm dia.	---
	Tensile strength	10 N	20 N	30 N	40 N
Length of exposed wire		10 ±1 mm			
Compliant standards		JIS C 2811 Terminal Blocks for Industrial Use			

Operating Characteristics

Characteristics	Type	Key-type Selector Switch	
		2 notches	3 notches
Operating force (OF) max.		0.1 N·m	
Set position (SP)		90±5°	45° ⁺¹⁰ ₀

Operation Angle

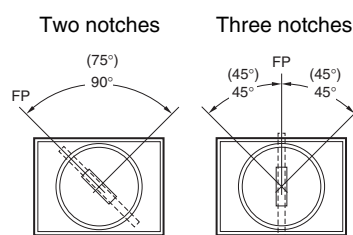

Note: The angle used for automatic reset is shown in parentheses.
FP: Free position

Contact Configuration

No. of notches	Contact configuration				
	SPDT		DPDT		
	Position	SW	Position	SW1	SW2
2 notches	↻	↻	↻	↻	↻
	↻	↻	↻	↻	↻
3 notches	---	---	↻	↻	↻
	---	---	↻	↻	↻
	---	---	↻	↻	↻

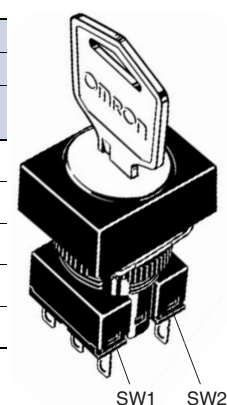

Nomenclature

Model Structure

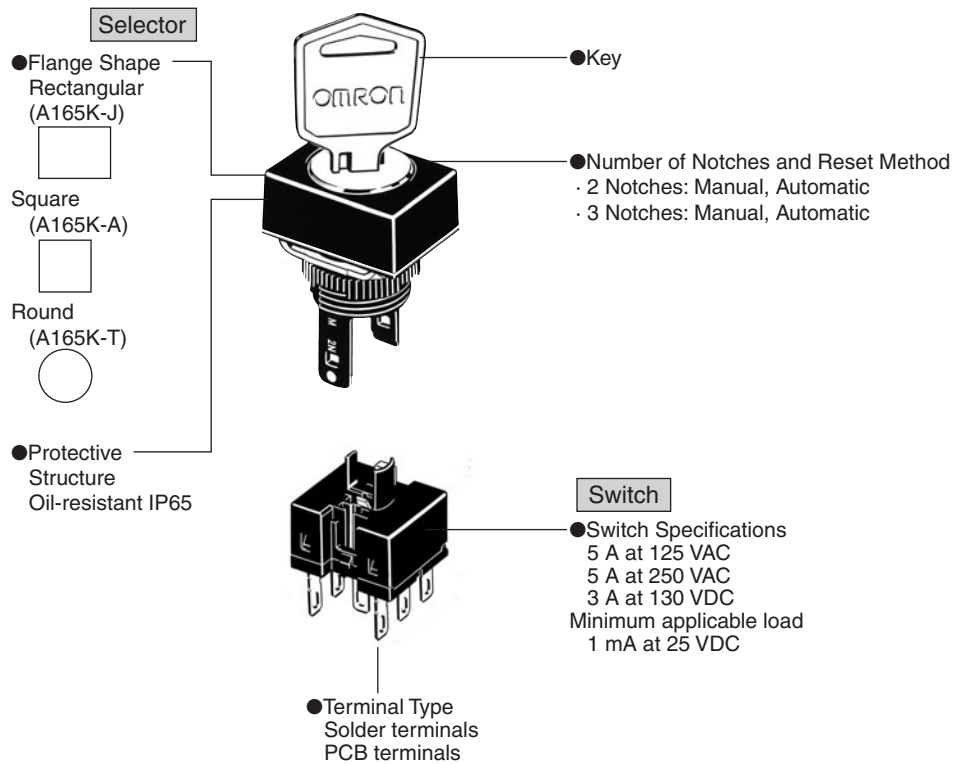

The flange can be rotated to easily change the operation angle of the knob.

For information on rotating the flange, refer to the A165S/W datasheet.

Example: Knob-type Selector Switch with Two Notches

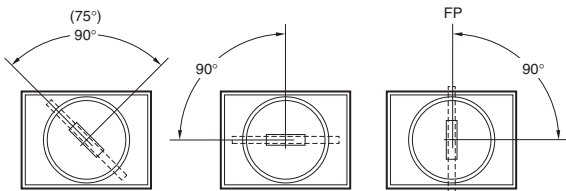

(Standard condition when shipped)

Note: The angle is 75° for self-resetting models.

Dimensions The Dimension shows 2-switch outputs.

Rectangular A165K-J Solder terminals (tab terminals #110)

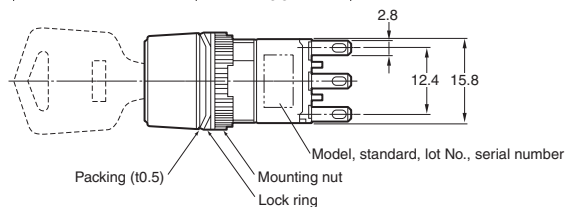
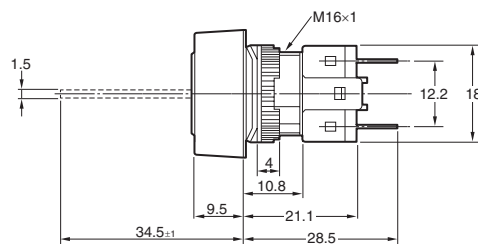
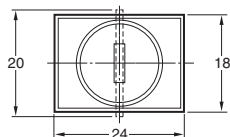
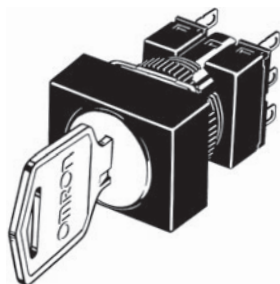

* Refer to the A165S/W for Panel cutouts.

Square A165K-A Solder terminals (tab terminals #110)

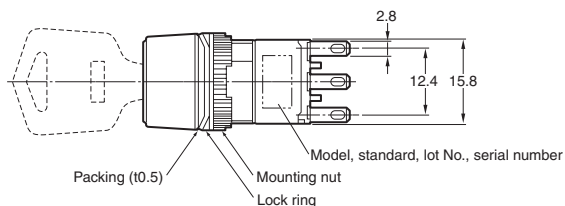
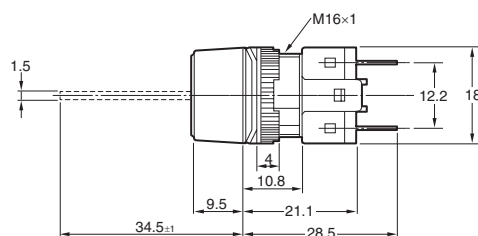
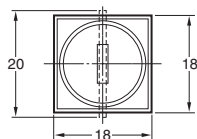
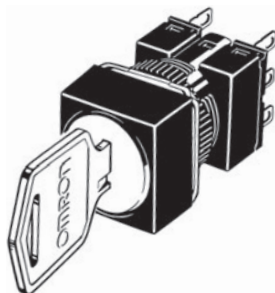

* Refer to the A165S/W for Panel cutouts.

Round A165K-T Solder terminals (tab terminals #110)

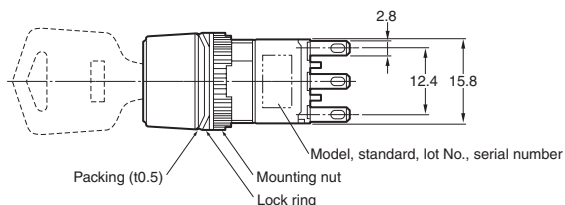
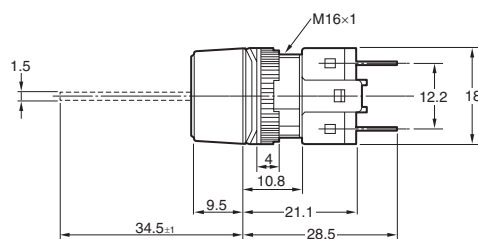
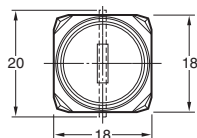
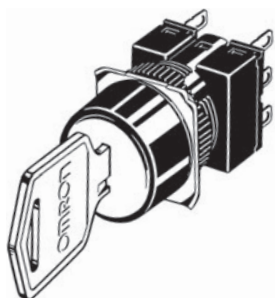

* Refer to the A165S/W for Panel cutouts.

Dimensions

• The Dimension shows 2-switch outputs. • The lamp terminal is also provided with non-lighted models. • A rectangular model is listed as an example. (Unit: mm)

Rectangular A165K□-2S

Screw-Less Clamp

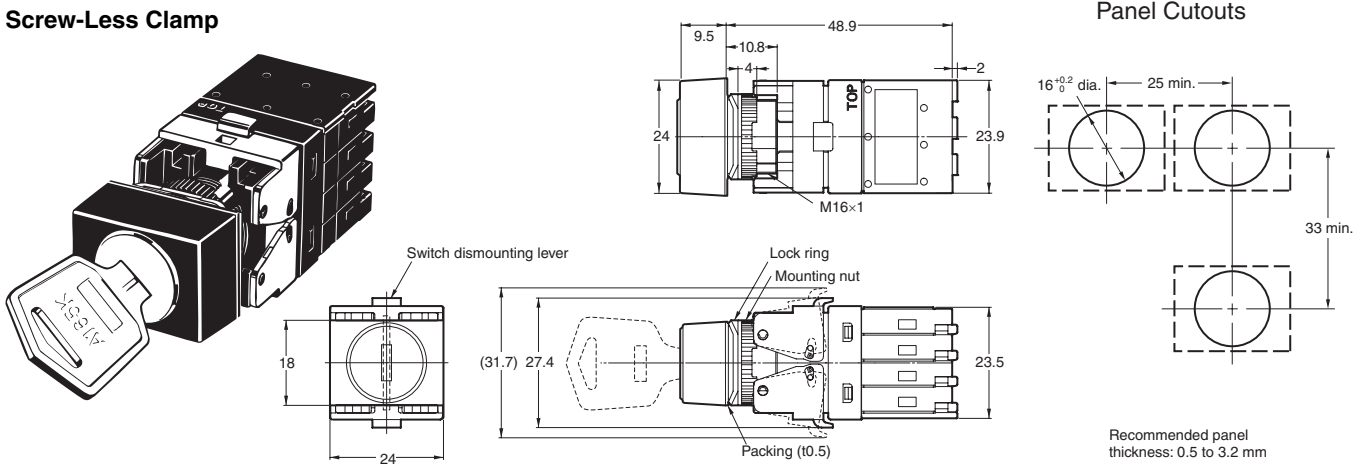

Terminal Arrangement

For information on the terminal arrangement, refer to the A165S/W datasheet.

Panel Mounting and Socket Unit Mounting and Removal

Refer to the A16 Pushbutton Switch datasheet.

Flange Rotation

Refer to the A165S/W datasheet.

Safety Precautions

Refer to *Safety Precautions for All Pushbutton Switches*.

WARNING

Do not apply a voltage between the incandescent lamp and the terminal that is greater than the rated voltage. If the incandescent lamp is broken, the operating part may pop out.



Always turn OFF the power and wait for 10 minutes before replacing the incandescent lamp. If the lamp is replaced immediately after the power is turned OFF, the remaining heat may cause burns.



Precautions for Correct Use

Mounting

- Always make sure that the power is turned OFF before mounting, removing, or wiring the Switch, or performing maintenance.
- Do not tighten the mounting nut more than necessary using tools such as pointed-nose pliers. Doing so will damage the mounting nut.
The tightening torque is 0.29 to 0.49 N·m.

Wiring

- Solder terminals and quick-connect terminals (#110) are commonly used for terminals.
- Be sure to use electrical wires that are a size appropriate for the applied voltage and carry current (conductor size is 0.5 to 0.75 mm²). Perform soldering according to the conditions provided below. If the soldering is not properly performed, the lead wires will become detached, resulting in short-circuits.
 1. Hand soldering: 350°C, within 3 s
 2. Dip soldering: 350°C, within 3 s
Wait for one minute after soldering before exerting any external force on the solder.
- Use non-corrosive resin fluid as the flux.
- Make sure that the electric cord is wired so that it does not touch the Unit. If the electric cord touches the Unit, then electric wires with a heat resistance of 100°C min. must be used.
- After wiring the Switch, maintain an appropriate clearance and creepage distance.

Operating Environment

- The IP65 model is designed with a degree of protection so that it will not sustain damage if it is subjected to water from any direction to the front of the panel.

Using the Microload

- Insert a contact protection circuit, if necessary, to prevent the reduction of life expectancy due to extreme wear on the contacts caused by loads where inrush current occurs when the contact is opened and closed.
- The A16 allows both a standard load (125 V at 5A, 250 V at 3 A) and a microload. If a standard load is applied, however, the microload area cannot be used. If the microload area is used with a standard load, the contact surface will become rough, and the opening and closing of the contact for a microload may become unreliable.
- The minimum applicable load is the N-level reference value. This value indicates the malfunction reference level for the reliability level of 60% ($\lambda 60$) (conforming to JIS C5003).
The equation, $\lambda 60 = 0.5 \times 10^{-4}/\text{operations}$ indicates that the estimated malfunction rate is less than 1/2,000,000 operations with a reliability level of 60%.

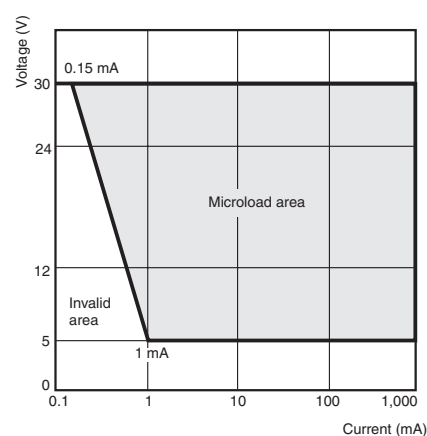

Others

- The oil-resistant IP65 uses NBR rubber and is resistant to general cutting oil and cooling oil. Some particular oils cannot be used with the oil-resistant IP65, however, so contact your OMRON representative for details.
- If the panel is to be finished with coating, etc., make sure that the panel meets the specified dimensions after the coating.
- Do not subject the Switch to extreme shock or vibration. Doing so will cause malfunctions and damage to the Switch.
Do not let sharp objects come into contact with the Switches that are made of resin. Doing so will damage the Switches, causing scratches on the outside of the operating parts, and malfunction. When handling the Switches, do not throw or drop them.

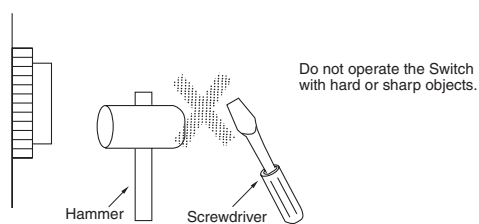
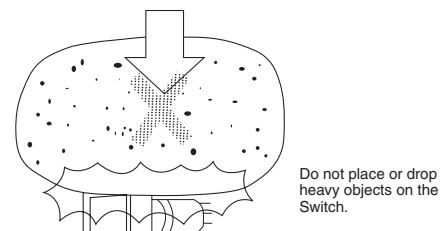
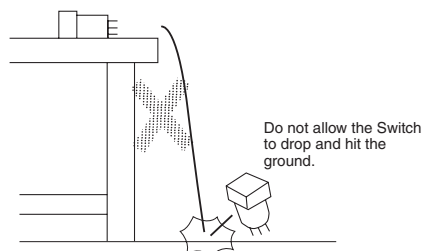

Read and Understand This Catalog

Please read and understand this catalog before purchasing the products. Please consult your OMRON representative if you have any questions or comments.

Warranty and Limitations of Liability

WARRANTY

OMRON's exclusive warranty is that the products are free from defects in materials and workmanship for a period of one year (or other period if specified) from date of sale by OMRON.

OMRON MAKES NO WARRANTY OR REPRESENTATION, EXPRESS OR IMPLIED, REGARDING NON-INFRINGEMENT, MERCHANTABILITY, OR FITNESS FOR PARTICULAR PURPOSE OF THE PRODUCTS. ANY BUYER OR USER ACKNOWLEDGES THAT THE BUYER OR USER ALONE HAS DETERMINED THAT THE PRODUCTS WILL SUITABLY MEET THE REQUIREMENTS OF THEIR INTENDED USE. OMRON DISCLAIMS ALL OTHER WARRANTIES, EXPRESS OR IMPLIED.

LIMITATIONS OF LIABILITY

OMRON SHALL NOT BE RESPONSIBLE FOR SPECIAL, INDIRECT, OR CONSEQUENTIAL DAMAGES, LOSS OF PROFITS OR COMMERCIAL LOSS IN ANY WAY CONNECTED WITH THE PRODUCTS, WHETHER SUCH CLAIM IS BASED ON CONTRACT, WARRANTY, NEGLIGENCE, OR STRICT LIABILITY.

In no event shall the responsibility of OMRON for any act exceed the individual price of the product on which liability is asserted.

IN NO EVENT SHALL OMRON BE RESPONSIBLE FOR WARRANTY, REPAIR, OR OTHER CLAIMS REGARDING THE PRODUCTS UNLESS OMRON'S ANALYSIS CONFIRMS THAT THE PRODUCTS WERE PROPERLY HANDLED, STORED, INSTALLED, AND MAINTAINED AND NOT SUBJECT TO CONTAMINATION, ABUSE, MISUSE, OR INAPPROPRIATE MODIFICATION OR REPAIR.

Application Considerations

SUITABILITY FOR USE

OMRON shall not be responsible for conformity with any standards, codes, or regulations that apply to the combination of products in the customer's application or use of the products.

At the customer's request, OMRON will provide applicable third party certification documents identifying ratings and limitations of use that apply to the products. This information by itself is not sufficient for a complete determination of the suitability of the products in combination with the end product, machine, system, or other application or use.

The following are some examples of applications for which particular attention must be given. This is not intended to be an exhaustive list of all possible uses of the products, nor is it intended to imply that the uses listed may be suitable for the products:

- Outdoor use, uses involving potential chemical contamination or electrical interference, or conditions or uses not described in this catalog.
- Nuclear energy control systems, combustion systems, railroad systems, aviation systems, medical equipment, amusement machines, vehicles, safety equipment, and installations subject to separate industry or government regulations.
- Systems, machines, and equipment that could present a risk to life or property.

Please know and observe all prohibitions of use applicable to the products.

NEVER USE THE PRODUCTS FOR AN APPLICATION INVOLVING SERIOUS RISK TO LIFE OR PROPERTY WITHOUT ENSURING THAT THE SYSTEM AS A WHOLE HAS BEEN DESIGNED TO ADDRESS THE RISKS, AND THAT THE OMRON PRODUCTS ARE PROPERLY RATED AND INSTALLED FOR THE INTENDED USE WITHIN THE OVERALL EQUIPMENT OR SYSTEM.

PROGRAMMABLE PRODUCTS

OMRON shall not be responsible for the user's programming of a programmable product, or any consequence thereof.

Disclaimers

CHANGE IN SPECIFICATIONS

Product specifications and accessories may be changed at any time based on improvements and other reasons.

It is our practice to change model numbers when published ratings or features are changed, or when significant construction changes are made. However, some specifications of the products may be changed without any notice. When in doubt, special model numbers may be assigned to fix or establish key specifications for your application on your request. Please consult with your OMRON representative at any time to confirm actual specifications of purchased products.

DIMENSIONS AND WEIGHTS

Dimensions and weights are nominal and are not to be used for manufacturing purposes, even when tolerances are shown.

PERFORMANCE DATA

Performance data given in this catalog is provided as a guide for the user in determining suitability and does not constitute a warranty. It may represent the result of OMRON's test conditions, and the users must correlate it to actual application requirements. Actual performance is subject to the OMRON Warranty and Limitations of Liability.

ERRORS AND OMISSIONS

The information in this document has been carefully checked and is believed to be accurate; however, no responsibility is assumed for clerical, typographical, or proofreading errors, or omissions.

2009.9

In the interest of product improvement, specifications are subject to change without notice.

OMRON Corporation
Industrial Automation Company

<http://www.ia.omron.com/>

(c)Copyright OMRON Corporation 2009 All Right Reserved.

Компания «Life Electronics» занимается поставками электронных компонентов импортного и отечественного производства от производителей и со складов крупных дистрибьюторов Европы, Америки и Азии.

С конца 2013 года компания активно расширяет линейку поставок компонентов по направлению коаксиальный кабель, кварцевые генераторы и конденсаторы (керамические, пленочные, электролитические), за счёт заключения дистрибьюторских договоров

Мы предлагаем:

- Конкурентоспособные цены и скидки постоянным клиентам.
- Специальные условия для постоянных клиентов.
- Подбор аналогов.
- Поставку компонентов в любых объемах, удовлетворяющих вашим потребностям.
- Приемлемые сроки поставки, возможна ускоренная поставка.
- Доставку товара в любую точку России и стран СНГ.
- Комплексную поставку.
- Работу по проектам и поставку образцов.
- Формирование склада под заказчика.
- Сертификаты соответствия на поставляемую продукцию (по желанию клиента).
- Тестирование поставляемой продукции.
- Поставку компонентов, требующих военную и космическую приемку.
- Входной контроль качества.
- Наличие сертификата ISO.

В составе нашей компании организован Конструкторский отдел, призванный помогать разработчикам, и инженерам.

Конструкторский отдел помогает осуществить:

- Регистрацию проекта у производителя компонентов.
- Техническую поддержку проекта.
- Защиту от снятия компонента с производства.
- Оценку стоимости проекта по компонентам.
- Изготовление тестовой платы монтаж и пусконаладочные работы.



Тел: +7 (812) 336 43 04 (многоканальный)
Email: org@lifeelectronics.ru