



E6486

User Manual

The New Vision of Touch™

QT60486 and QT60326 QMatrix™ IC Evaluation and Development Kit

OVERVIEW

This kit is designed for evaluation and development of QT60486 and QT60326-based *glass touch* matrix circuits. It includes all circuitry and materials required to make a fully-functioning, 48-key matrix touch control. This board has an RS232 serial interface that allows connection to a PC for function setup and data viewing. The E6486 makes use of QmBtn™ software, which is included.

The QT chip in this board uses two interfaces: SPI for high-speed synchronous communications or RS232 for communications with a PC. The RS232 interface is the primary interface used for evaluation.

A 16-pin header connector on the end of the board allows connection to a matrix panel. A 48-key sample matrix and plastic panel are supplied with the kit. An LED status indicator shows detection and error states.

For more detailed information about this product, please refer to the QT60486 datasheet.

Materials Provided:

- 1x E6486 eval board
- 1x Matrix Panel with 48 keys
- 1x RS232 serial cable
- 1x 9v Battery
- 1x CD-ROM with QmBtn™ software (or get the latest from www.qprox.com/downloads)
- 1x User Guide

You will also need:

A PC running any recent version of Windows (98, 98SE, NT4, 2000, XP) upwards, with a free RS232 port (Com 1 or Com 2).

BOARD PREPARATION

Before powering up, prepare the matrix panel and board using the following steps:

- 1 Place the panel on a bench so that it will be elevated and mechanically stable, otherwise you will get wildly fluctuating signal levels when you press on the panel.
- 2 Attach the 9V battery snap (or other power leads) to the board's power terminal block.

SETUP

After you have prepared the board and matrix, get the unit to run as follows:

- 1 Plug the matrix tail into the board's matrix connector. The matrix panel should be flex-side down so that you touch the plastic panel, not the flex.
- 2 Connect the E6486 to a PC using the RS232 serial cable (supplied). Make sure the serial port is not currently used by any other application or driver (like mouse software) and there are no Com conflicts. The board will work on Com 1 or Com 2.
- 3 Run the QmBtn™ software (on the supplied CD or from www.qprox.com/downloads).
- 4 Apply +8 to +20VDC to the screw terminal block. This can be a 9V alkaline battery or a bench supply.
- 5 The board should start communicating with QmBtn™, and you will see an array of 48 buttons as shown on the right.

If the board does not communicate with the PC, make sure the jumper J4 (located next to the power connector) is set on 'UART', then cycle power off and on again.

If the setups are correct, touching the keys on the panel will cause the QmBtn™ buttons to depress. The last key touched will leave an 'X' on the key afterwards. You can open the 'Key Settings' window and look at the signals from any specific key by clicking with your mouse on the key representation. You can change the settings for the chosen key or all keys using the 'Key Settings' window. You can also view all 48 signals in bar graph form in the 'Signal Levels' window.

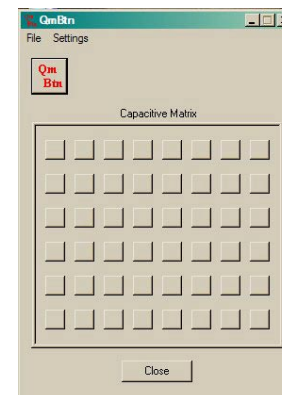

QmBtn™ Operation

BOARD DETAILS

Please refer to figure 2 on page 9

Power Terminal

This screw terminal strip is used to power the board. The voltage should be between +8 and +20VDC. Power should be free from switching noise and short-term fluctuations for best performance. Be sure to check for low voltage periodically if using a battery; low voltage will cause erratic performance.

RS232 (UART) Connector

This connector provides direct communications between the E6486 and the PC. It allows full control over the device including calibration and setups. It also allows for real-time supervision of signal, reference and calibration information. Use a straight-through type cable (supplied) — also known as an extender cable — to a PC. The RS232 and SPI interfaces cannot operate at the same time.

Matrix Connector

The E6486 has two headers (J2 and J3). The pinout of both ports is described in table 1 (page 7). The header provides the X-Y scanning of the matrix electrode. X lines drive charge into the matrix, and the Y lines conduct the charge back out. The keyboard supplied with the kit can be connected directly to J3.

Communication Port Select

The UART port can either come from the RS232 connector or from J1. This jumper allows the user to select the source of the UART signal.

J4	UART Source
RS232	RS232 Connector
DIRECT	J1

SPI / UART Direct Port

J1 header gives access to all the signals useful for communicating with the QT60486 or QT60326. The pinout of the connector is described below:

Pin	J1	Description
1	MISO	SPI - Data Input
2	Vcc	Power; +5V
3	SCK	SPI - Clock Input
4	MOSI	SPI - Data Output
5	/RST	Reset
6	GND	Supply Ground
7	n.c.	n.c.
8	n.c.	n.c.
9	/DRDY	SPI - Data Ready
10	/SS	SPI - Slave Select
11	Rx	UART - Receive
12	Tx	UART - Transmit
13	WS	Wake-up from sleep input / sync input
14	STATUS	Status Output

The QT60486/QT60326 can use either SPI or UART communications modes; it cannot use both at the same time. The part defaults to SPI mode unless it receives a byte over the UART interface. If a UART byte is received at any time, the UART interface is enabled and the SPI interface is totally disabled until after the next device reset.

The QT60486 datasheet contains substantial additional information on communications.

SCHEMATIC DIAGRAM

Figure 1 — Schematic Diagram

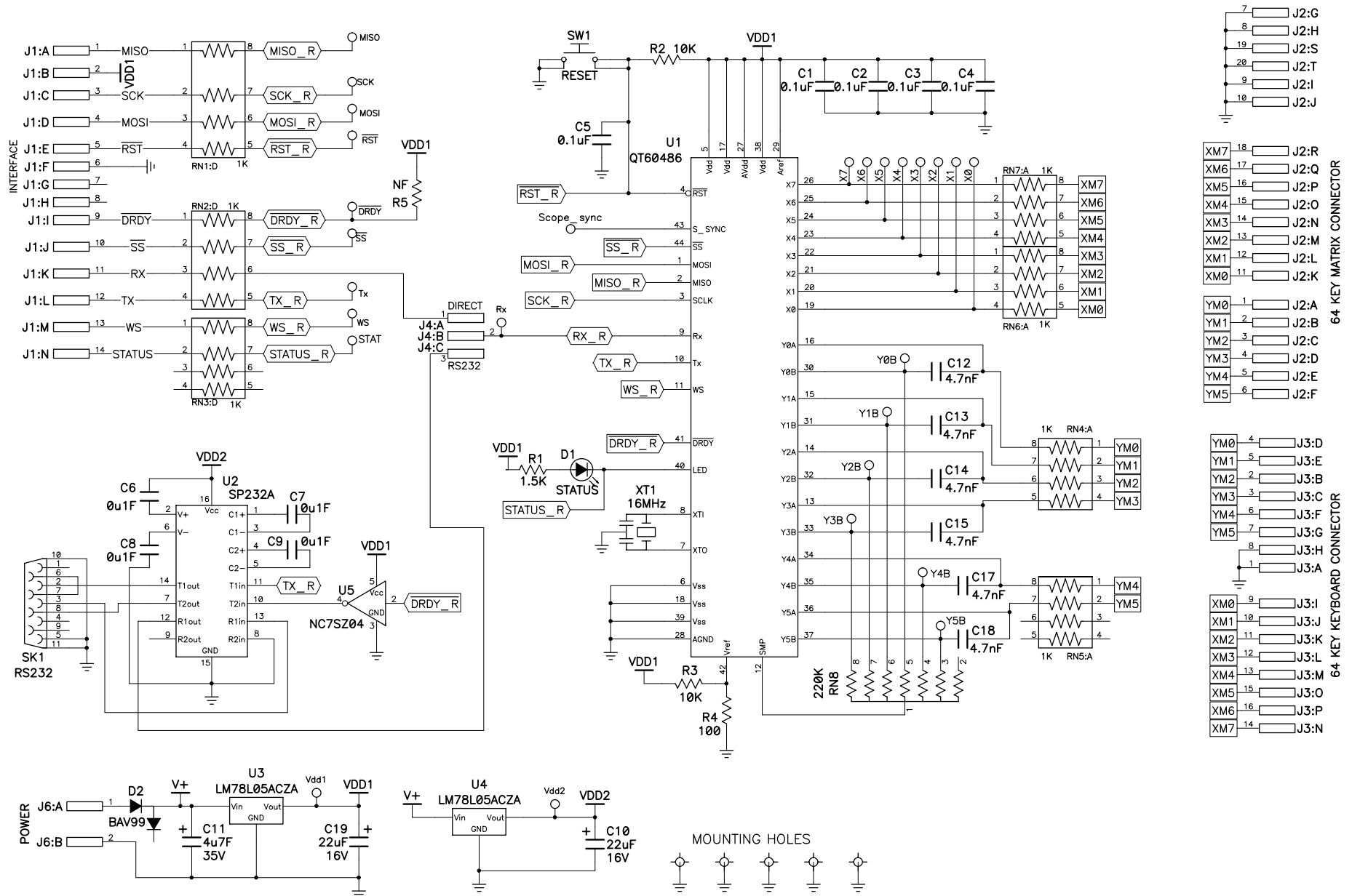

Sync/Sleep

This input performs two functions: wake-up from sleep input, or noise synchronization input.

Wake from Sleep via UART: Link this input to the Rx line to enable wake from sleep via UART. In this mode, the device will wake when a dummy transmission (a null byte) is received from the host over the UART RX line. The logic level change of the UART RX line is used to create a wakeup logic input to the chip's WS pin.

Wake from Sleep via SPI: Link this input to MOSI to enable wake from sleep via SPI. In this mode, the device will wake when a dummy transmission (a null byte) is received from the host over the SPI lines. The logic level change of the MOSI line is used to create a wakeup logic input to the chip's WS pin.

External Wake from Sleep: Feed a minimum 5us sync pulse (normal logic high, pulse low) to pin 13 of J1 with respect to GND to wake the part from a sleep state.

External Noise Sync: Feed a TTL or 5V CMOS synchronization pulse into pin 13 of J1 with respect to GND.

The QT60486 / QT60326 acquisition bursts can be synchronized to an external source of repetitive electrical noise, such as 50Hz or 60Hz using the Noise Sync feature, which is enabled via Setups. External repetitive signals are thereby heavily suppressed, since the system and the noise become synchronized and no longer beat or alias with respect to each other. The sync input triggers the burst for key 0 (X0Y0); the device waits for the sync signal for up to 100 ms after the end of a preceding full matrix scan (after key #47), then, when a sync pulse is received, the matrix is scanned in its entirety one time. If no sync pulse is received in 100ms, the part wakes on its own and re-scans the matrix one time then goes back to sleep. Sync pulses should be spaced no more than 99ms apart to prevent this from happening.

Reset / Recal Button

This button causes a hard reset and a recalibration of all keys. The recalibrate button in QmBtn™ will also accomplish a recalibration of all or some keys depending on current Scope. It is also possible to cause a hard reset via QmBtn™.

Oscilloscope Sync

The 'scope sync' test point can be used to synchronize an oscilloscope. When enabled in QmBtn™, this signal provides a pulse that brackets the chosen burst or bursts, making diagnostics much simpler. With the scope sync enabled for one key, the X matrix drive signals can be clearly seen.

Status LED

The LED shows touch and error activity. If there is a calibration error or another type of fault, this LED will glow solid. If the part is working normally, and no keys are detecting, the LED will be off. If one or more keys are touched, the LED will flicker. The brightness of the flicker will be proportional to the number of keys detecting.

Cs Capacitors

The Cs capacitors, C12, C13, C14, C15, C17, C18 are the charge integrators that are used to detect changes in key capacitance. Corresponding resistor network RN8 is used to convert the acquired charge to digital form. These parts are optimal and should not be changed in value without a known reason.



Figure 2 — Board Layout

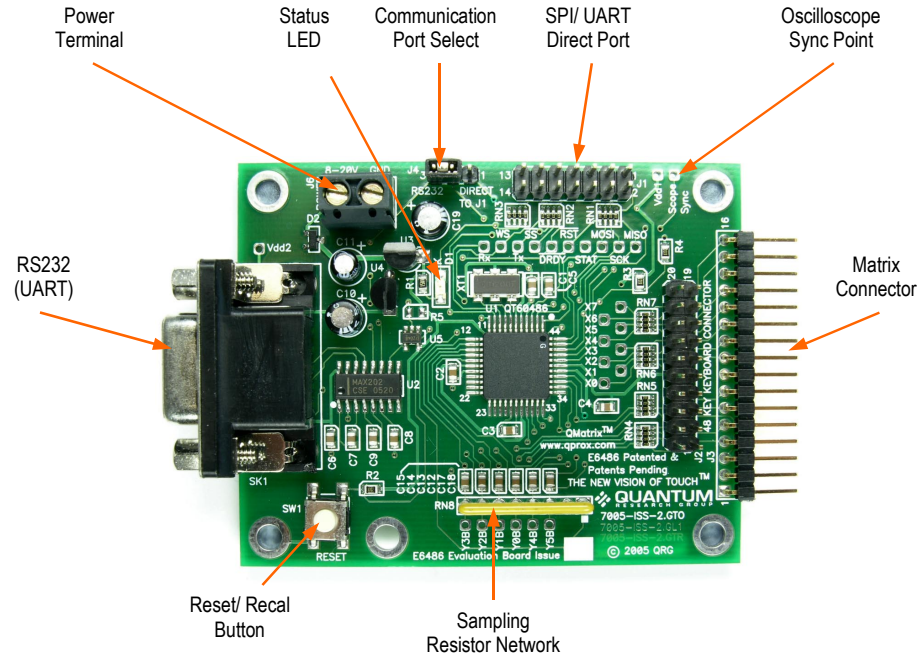

Table 1 — Matrix Connector Pinout

XM_n = X matrix drive pulses (driven by chip)
 YM_n = Y matrix receive lines (input to chip)

Pin	J2	J3
1	YM0	GND
2	YM1	YM2
3	YM2	YM3
4	YM3	YM0
5	YM4	YM1
6	YM5	YM4
7	GND	YM5
8	GND	GND
9	GND	XM0
10	GND	XM1
11	XM0	XM2
12	XM1	XM3
13	XM2	XM4
14	XM3	XM7
15	XM4	XM5
16	XM5	XM6
17	XM6	-
18	XM7	-
19	GND	-
20	GND	-

PCB LAYERS

Figure 3 — Silk Layer

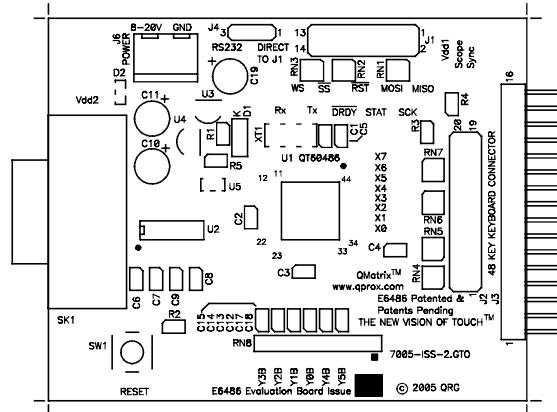

Figure 4 — Top Layer

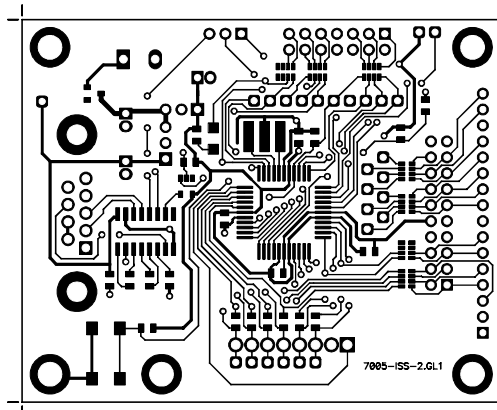
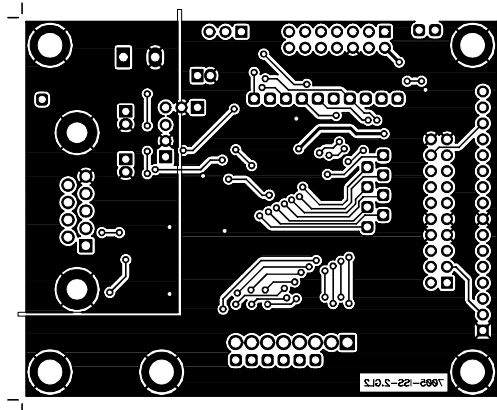

Figure 5 — Bottom Layer



TROUBLESHOOTER

Board Will Not Communicate with PC

▶ Bad Serial Connections

⇒ Check/replace serial cable

▶ Bad or Conflicting Com Port on PC

⇒ Shut down other tasks that may also be using the same com port IRQ or I/O address on the PC

⇒ Use a different PC

▶ Low Battery or Power Supply Out of Usable Range

⇒ Restore power to within correct range

▶ J4 is on the Wrong Setting

Board Will Not Calibrate

▶ Excess Capacitive Load

⇒ Reduce burst length

⇒ Reduce Cx loading

▶ Shorted X or Y Matrix Line

▶ Low Power Supply Voltage

Noisy or Erratic Signal

▶ Noisy Power Supply

⇒ Matrix or matrix cable too close to a noise source such as a power line or switching noise source

⇒ Use *Noise Sync* feature to overcome

⇒ Increase distance to noise source

⇒ Place grounded shield between noise source and matrix

▶ Ground Loop Interference

▶ Matrix or Matrix Cable not Mechanically Stable

▶ Strong RFI from a Transmitter or Adjacent Digital Product

▶ Insufficient Signal Filtering

⇒ Increase burst length and threshold level

⇒ Increase the detection integrator level

Corporate Headquarters

1 Mitchell Point
Ensign Way, Hamble
Southampton SO31 4RF
United Kingdom

Tel +44 (0)23 8056 5600
Fax +44 (0)23 8045 3939

Email sales@qprox.com

North America

651 Holiday Drive Bldg. 5 / 300
Pittsburgh, PA 15220
USA

Tel 412-391-7367
Fax 412-291-1015

Copyright © 2004 QRG Ltd
Version 200.180805
All rights reserved
Patented and patents pending

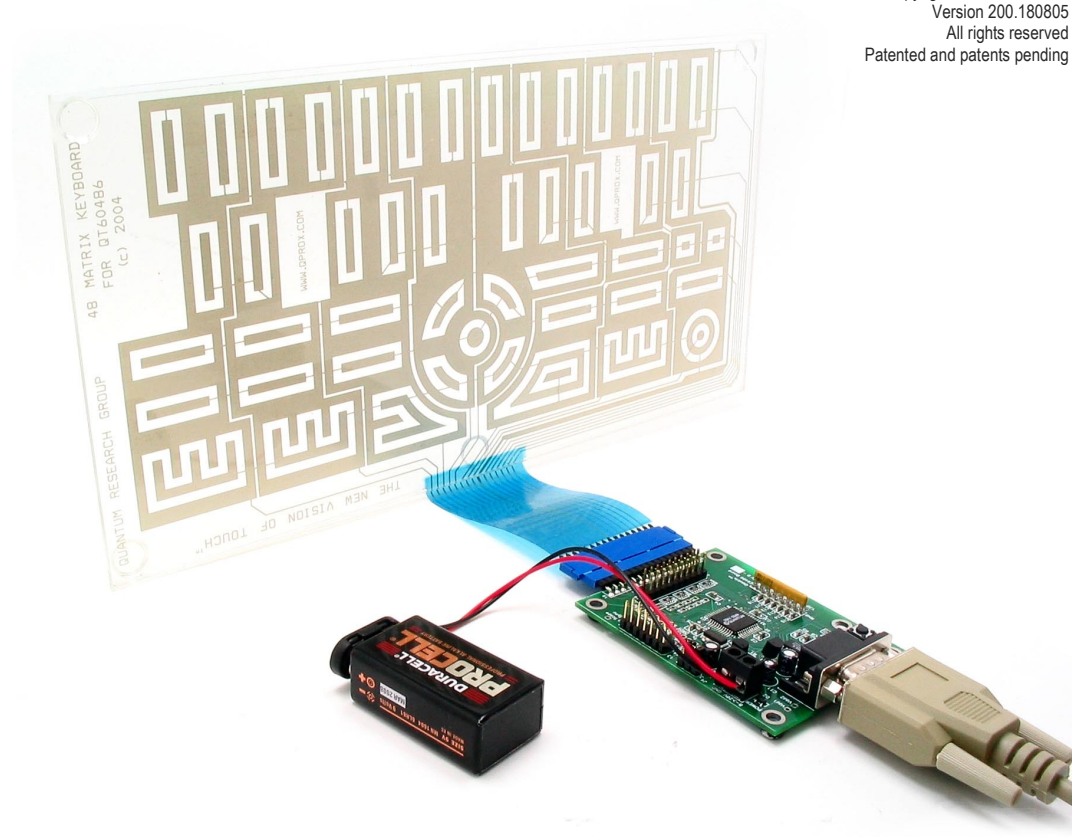

Компания «Life Electronics» занимается поставками электронных компонентов импортного и отечественного производства от производителей и со складов крупных дистрибьюторов Европы, Америки и Азии.

С конца 2013 года компания активно расширяет линейку поставок компонентов по направлению коаксиальный кабель, кварцевые генераторы и конденсаторы (керамические, пленочные, электролитические), за счёт заключения дистрибьюторских договоров

Мы предлагаем:

- Конкурентоспособные цены и скидки постоянным клиентам.
- Специальные условия для постоянных клиентов.
- Подбор аналогов.
- Поставку компонентов в любых объемах, удовлетворяющих вашим потребностям.
- Приемлемые сроки поставки, возможна ускоренная поставка.
- Доставку товара в любую точку России и стран СНГ.
- Комплексную поставку.
- Работу по проектам и поставку образцов.
- Формирование склада под заказчика.
- Сертификаты соответствия на поставляемую продукцию (по желанию клиента).
- Тестирование поставляемой продукции.
- Поставку компонентов, требующих военную и космическую приемку.
- Входной контроль качества.
- Наличие сертификата ISO.

В составе нашей компании организован Конструкторский отдел, призванный помогать разработчикам, и инженерам.

Конструкторский отдел помогает осуществить:

- Регистрацию проекта у производителя компонентов.
- Техническую поддержку проекта.
- Защиту от снятия компонента с производства.
- Оценку стоимости проекта по компонентам.
- Изготовление тестовой платы монтаж и пусконаладочные работы.



Тел: +7 (812) 336 43 04 (многоканальный)
Email: org@lifeelectronics.ru