

## Glass Passivated Ultrafast Bridge Rectifier

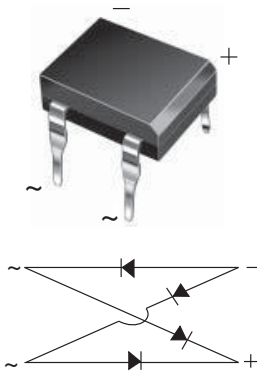

Case Style DFM

### FEATURES

- Ideal for automated placement
- High surge current capability
- Solder dip 275 °C max. 10 s, per JESD 22-B106
- Compliant to RoHS Directive 2002/95/EC and in accordance to WEEE 2002/96/EC

**RoHS**  
COMPLIANT

### TYPICAL APPLICATIONS

General purpose use in AC/DC bridge full wave rectification for SMPS, lighting ballaster, adapter, battery charger, home appliances, office equipment, and telecommunication applications.

### MECHANICAL DATA

**Case:** DFM

Molding compound meets UL 94 V-0 flammability rating  
Base P/N-E3 - RoHS compliant, commercial grade

**Terminals:** Matte tin plated leads, solderable per J-STD-002 and JESD22-B102

E3 suffix for consumer grade, meets JESD 201 class 1A whisker test

**Polarity:** As marked on body

### PRIMARY CHARACTERISTICS

$I_{F(AV)}$	0.9 A
$V_{RRM}$	65 V to 600 V
$I_{FSM}$	45 A
$I_R$	10 $\mu$ A
$V_F$	1.0 V
$T_J$ max.	125 °C

### MAXIMUM RATINGS ( $T_A = 25$ °C unless otherwise noted)

PARAMETER	SYMBOL	B40 C800DM	B80 C800DM	B125 C800DM	B250 C800DM	B380 C800DM	UNIT
Maximum repetitive peak reverse voltage	$V_{RRM}$	65	125	200	400	600	V
Maximum RMS input voltage R- and C-load	$V_{RMS}$	40	80	125	250	380	V
Maximum average forward output current for free air operation at $T_A = 45$ °C R- and L-load C-load	$I_{F(AV)}$	0.9 0.8					A
Maximum DC blocking voltage	$V_{DC}$	65	125	200	400	600	V
Maximum peak working voltage	$V_{RWM}$	90	180	300	600	900	V
Maximum non-repetitive peak voltage	$V_{RSM}$	100	200	350	650	1000	V
Maximum repetitive peak forward surge current	$I_{FRM}$	10					A
Peak forward surge current single sine-wave on rated load	$I_{FSM}$	45					A
Rating for fusing at $T_J = 125$ °C ( $t < 100$ ms)	$I^2t$	10					A <sup>2</sup> s
Minimum series resistor C-load at $V_{RMS} = \pm 10$ %	$R_T$	1.0	2.0	4.0	8.0	12.0	$\Omega$
Maximum load capacitance + 50 % - 10 %	$C_L$	5000	2500	1000	500	200	$\mu$ F
Operating junction temperature range	$T_J$	- 40 to + 125					°C
Storage temperature range	$T_{STG}$	- 40 to + 150					°C



ELECTRICAL CHARACTERISTICS (T <sub>A</sub> = 25 °C unless otherwise noted)								
PARAMETER	TEST CONDITIONS	SYMBOL	B40 C800DM	B80 C800DM	B125 C800DM	B250 C800DM	B380 C800DM	UNIT
Maximum instantaneous forward voltage drop per diode	0.9 A	V <sub>F</sub>	1.0					V
Maximum reverse current at rated repetitive peak voltage per diode		I <sub>R</sub>	10					μA

THERMAL CHARACTERISTICS (T <sub>A</sub> = 25 °C unless otherwise noted)							
PARAMETER	SYMBOL	B40 C800DM	B80 C800DM	B125 C800DM	B250 C800DM	B380 C800DM	UNIT
Typical thermal resistance <sup>(1)</sup>	R <sub>θJA</sub> R <sub>θJL</sub>	40			15		°C/W

**Note**

<sup>(1)</sup> Thermal resistance from junction to ambient and from junction to lead mounted on PCB with 0.5" x 0.5" (13 mm x 13 mm) copper pads

ORDERING INFORMATION (Example)				
PREFERRED P/N	UNIT WEIGHT (g)	PREFERRED PCKAGE CODE	BASE QUANTITY	DELIVERY MODE
B380C800DM-E3/45	0.416	45	50	Tube

### RATINGS AND CHARACTERISTICS CURVES (T<sub>A</sub> = 25 °C unless otherwise noted)

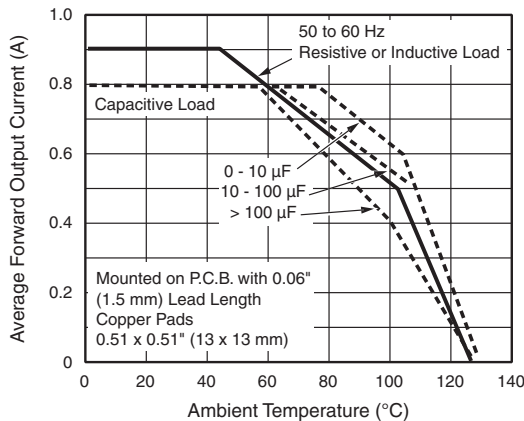

Fig. 1 - Derating Curves Output Rectified Current for B40C800D...B125C800DM

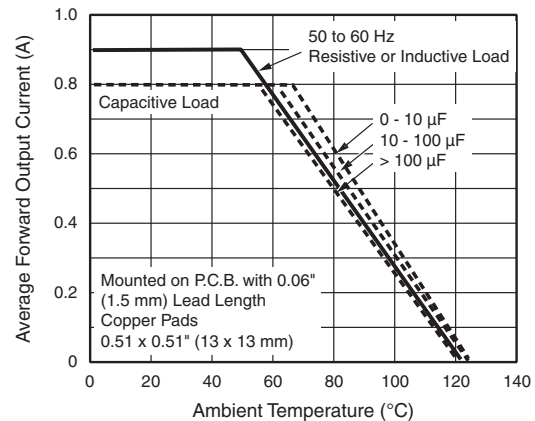

Fig. 2 - Derating Curves Output Rectified Current for B250C800D...B360C800DM

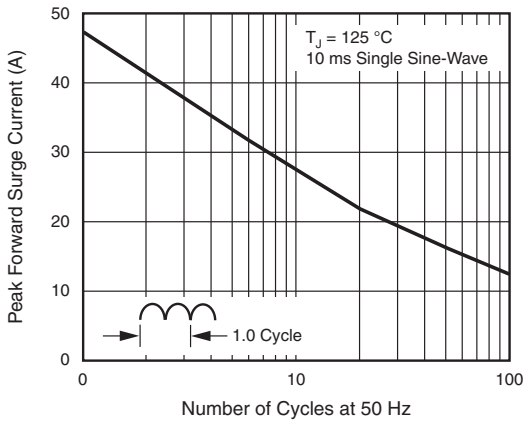

Fig. 3 - Maximum Non-Repetitive Peak Forward Surge Current Per Diode

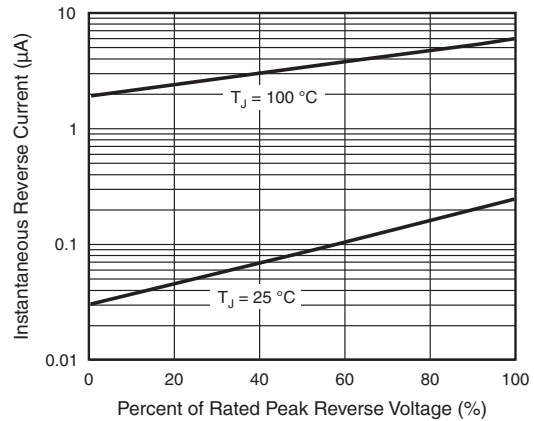

Fig. 5 - Typical Reverse Leakage Characteristics Per Diode

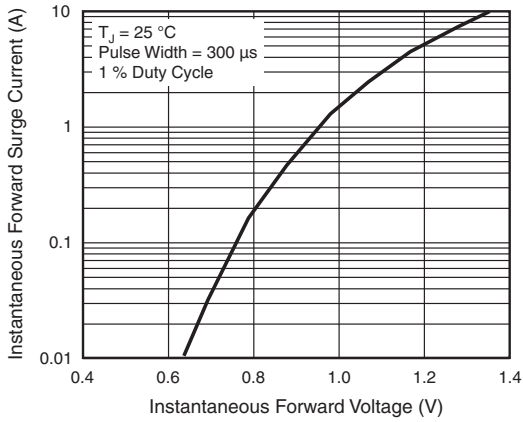

Fig. 4 - Typical Forward Characteristics Per Diode

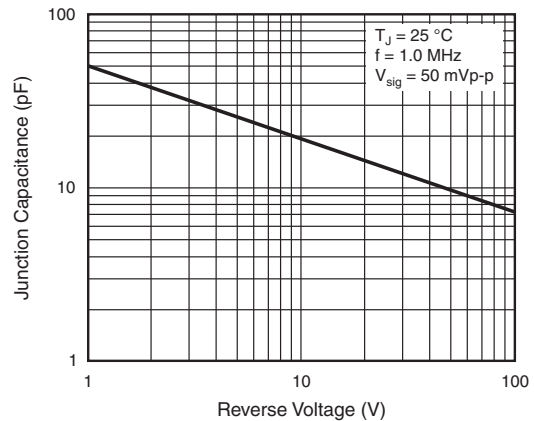
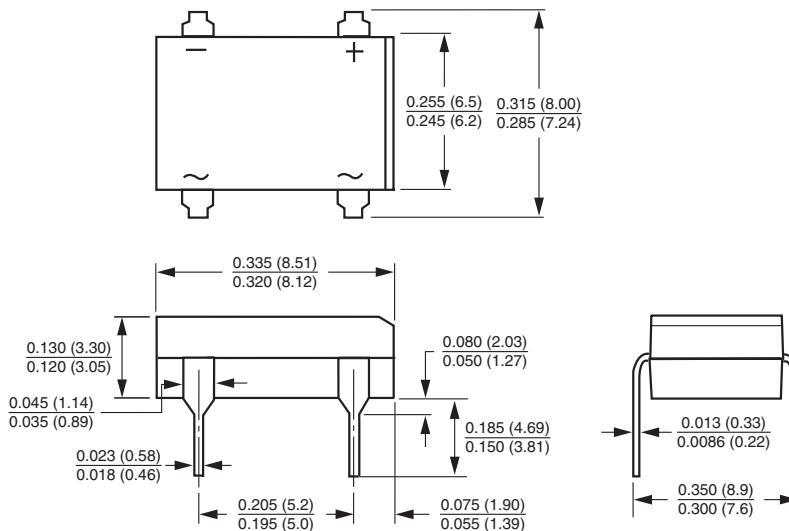

Fig. 6 - Typical Junction Capacitance Per Diode

## PACKAGE OUTLINE DIMENSIONS in inches (millimeters)

### Case Style DFM





## Disclaimer

ALL PRODUCT, PRODUCT SPECIFICATIONS AND DATA ARE SUBJECT TO CHANGE WITHOUT NOTICE TO IMPROVE RELIABILITY, FUNCTION OR DESIGN OR OTHERWISE.

Vishay Intertechnology, Inc., its affiliates, agents, and employees, and all persons acting on its or their behalf (collectively, "Vishay"), disclaim any and all liability for any errors, inaccuracies or incompleteness contained in any datasheet or in any other disclosure relating to any product.

Vishay makes no warranty, representation or guarantee regarding the suitability of the products for any particular purpose or the continuing production of any product. To the maximum extent permitted by applicable law, Vishay disclaims (i) any and all liability arising out of the application or use of any product, (ii) any and all liability, including without limitation special, consequential or incidental damages, and (iii) any and all implied warranties, including warranties of fitness for particular purpose, non-infringement and merchantability.

Statements regarding the suitability of products for certain types of applications are based on Vishay's knowledge of typical requirements that are often placed on Vishay products in generic applications. Such statements are not binding statements about the suitability of products for a particular application. It is the customer's responsibility to validate that a particular product with the properties described in the product specification is suitable for use in a particular application. Parameters provided in datasheets and/or specifications may vary in different applications and performance may vary over time. All operating parameters, including typical parameters, must be validated for each customer application by the customer's technical experts. Product specifications do not expand or otherwise modify Vishay's terms and conditions of purchase, including but not limited to the warranty expressed therein.

Except as expressly indicated in writing, Vishay products are not designed for use in medical, life-saving, or life-sustaining applications or for any other application in which the failure of the Vishay product could result in personal injury or death. Customers using or selling Vishay products not expressly indicated for use in such applications do so at their own risk. Please contact authorized Vishay personnel to obtain written terms and conditions regarding products designed for such applications.

No license, express or implied, by estoppel or otherwise, to any intellectual property rights is granted by this document or by any conduct of Vishay. Product names and markings noted herein may be trademarks of their respective owners.

## Material Category Policy

**Vishay Intertechnology, Inc. hereby certifies that all its products that are identified as RoHS-Compliant fulfill the definitions and restrictions defined under Directive 2011/65/EU of The European Parliament and of the Council of June 8, 2011 on the restriction of the use of certain hazardous substances in electrical and electronic equipment (EEE) - recast, unless otherwise specified as non-compliant.**

**Please note that some Vishay documentation may still make reference to RoHS Directive 2002/95/EC. We confirm that all the products identified as being compliant to Directive 2002/95/EC conform to Directive 2011/65/EU.**

**Vishay Intertechnology, Inc. hereby certifies that all its products that are identified as Halogen-Free follow Halogen-Free requirements as per JEDEC JS709A standards. Please note that some Vishay documentation may still make reference to the IEC 61249-2-21 definition. We confirm that all the products identified as being compliant to IEC 61249-2-21 conform to JEDEC JS709A standards.**

Компания «Life Electronics» занимается поставками электронных компонентов импортного и отечественного производства от производителей и со складов крупных дистрибьюторов Европы, Америки и Азии.

С конца 2013 года компания активно расширяет линейку поставок компонентов по направлению коаксиальный кабель, кварцевые генераторы и конденсаторы (керамические, пленочные, электролитические), за счёт заключения дистрибьюторских договоров

Мы предлагаем:

- Конкурентоспособные цены и скидки постоянным клиентам.
- Специальные условия для постоянных клиентов.
- Подбор аналогов.
- Поставку компонентов в любых объемах, удовлетворяющих вашим потребностям.
- Приемлемые сроки поставки, возможна ускоренная поставка.
- Доставку товара в любую точку России и стран СНГ.
- Комплексную поставку.
- Работу по проектам и поставку образцов.
- Формирование склада под заказчика.
- Сертификаты соответствия на поставляемую продукцию (по желанию клиента).
- Тестирование поставляемой продукции.
- Поставку компонентов, требующих военную и космическую приемку.
- Входной контроль качества.
- Наличие сертификата ISO.

В составе нашей компании организован Конструкторский отдел, призванный помогать разработчикам, и инженерам.

Конструкторский отдел помогает осуществить:

- Регистрацию проекта у производителя компонентов.
- Техническую поддержку проекта.
- Защиту от снятия компонента с производства.
- Оценку стоимости проекта по компонентам.
- Изготовление тестовой платы монтаж и пусконаладочные работы.



Тел: +7 (812) 336 43 04 (многоканальный)

Email: [org@lifeelectronics.ru](mailto:org@lifeelectronics.ru)