

Rack and Panel Connectors Subminiature Rectangular

SMP20

SMS20

ELECTRICAL SPECIFICATIONS

Current Rating: 7.5 A

Breakdown Voltage:

At sea level: 2000 V_{RMS}

At 70 000 feet [21 336 meters]: 500 V_{RMS}

PHYSICAL SPECIFICATIONS

Number of Contacts: 5, 7, 11, 14, 20, 26, 34, 42, 50, 75

Contact Spacing: 0.120" [3.05 mm]

Contact Gauge: #20 AWG

Minimum Creepage Path Between Contacts:

0.080" [2.03 mm]

Minimum Air Space Between Contacts: 0.050" [1.27 mm]

FEATURES

- Lightweight
- Polarized by guides or screwlocks
- Screwlocks lock connectors together to withstand vibration and accidental disconnect
- Overall height kept to a minimum
- Floating contacts aid in alignment and in withstanding vibration
- Contacts, precision machined and individually gauged, provide high reliability
- Insertion and withdrawal forces kept low without increasing contact resistance
- Contact plating provides protection against corrosion, assures low contact resistance and ease of soldering

APPLICATIONS

For use wherever space is at a premium and a high quality connector is required in avionics, automation, communications, controls, instrumentation, missiles, computers and guidance systems.

MATERIAL SPECIFICATIONS

Contact Pin: Brass, gold plated

Contact Socket: Phosphor bronze, gold plated

(Beryllium copper available on request)

Guides: Stainless steel, passivated

Screwlocks: Stainless steel, passivated

Standard Body: Glass-filled diallyl phthalate per MIL-M-14, Model GDI-30F, green

DIMENSIONS in inches [millimeters]

SMS With Fixed Standard Guides	SMDS - DETAIL B Dip Solder Contact Option	SMP With Fixed Standard Guides	SMDP - DETAIL C Dip Solder Contact Option
<p>0.190 [4.83] Typ.</p> <p>0.470 [11.94]</p> <p>0.220 [5.59]</p> <p>2-56 UNC-2A Threads Typ.</p> <p>0.156 [3.96] Typ.</p> <p>See Detail B</p>	<p>0.187 [4.75] Typ.</p> <p>0.030 [0.762] Typ.</p>	<p>0.530 [13.46]</p> <p>0.120 [3.05]</p> <p>0.220 [5.59]</p> <p>0.141 [3.58] Typ.</p> <p>0.046 [1.17] Dia. Solder Cup #20 AWG Typ.</p> <p>0.040 [1.02] Dia. Typ.</p> <p>See Detail C</p>	<p>0.141 [3.58] Typ.</p> <p>0.187 [4.75] Typ.</p> <p>0.030 [0.762] Typ.</p> <p>0.040 ± 0.001 [1.02 ± 0.025] Dia. Typ.</p>
<p>0.520 [13.21]</p> <p>0.220 [5.59]</p> <p>0.110 [2.79]</p> <p>2-56 UNC-2A Thread is standard</p>	<p>0.920 [23.37]</p> <p>0.220 [5.59]</p> <p>0.120 [3.05]</p>	<p>0.910 [23.11]</p> <p>0.220 [5.59]</p> <p>0.110 [2.79]</p> <p>0.046 [1.17] Wide x 0.062 [1.57] Deep Typ.</p> <p>2-56 UNC-2A Thread is standard</p>	<p>0.530 [13.46]</p> <p>0.220 [5.59]</p> <p>0.120 [3.05]</p>

DIMENSIONS in inches [millimeters]

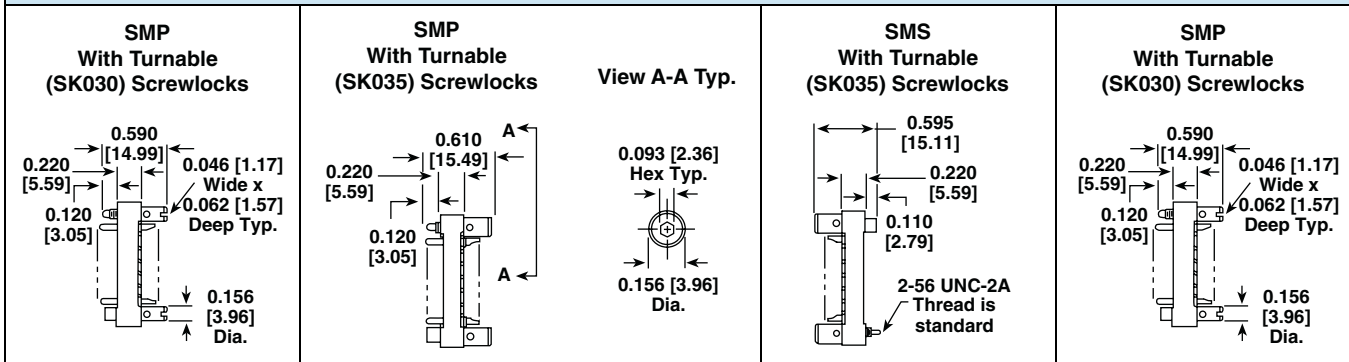

TERMINAL VARIATIONS in inches [millimeters]

DIP SOLDER PC BOARD MOUNTING PATTERNS

Male (SMP) Connector is shown - Female is opposite. Contact row and Mating Hole \varnothing to \varnothing Dimensions also applies to Solder Cup Connectors.

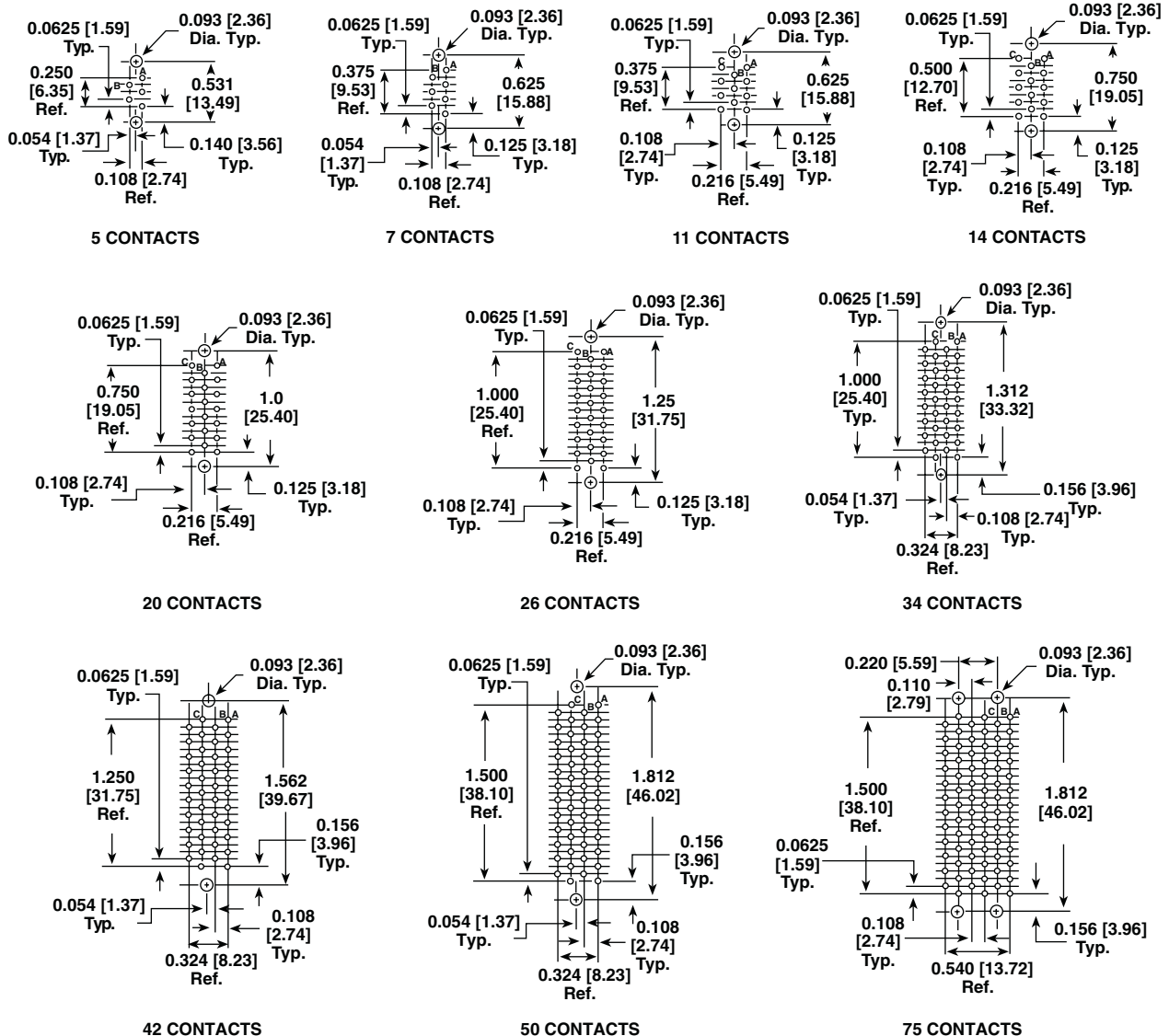

DIMENSIONS in inches [millimeters]

NOTE: The views below show the wiring side of a pin model connector (female is opposite). Socket hardware is assembled at "A" contact end of a pin model connector.



5 CONTACTS

7 CONTACTS

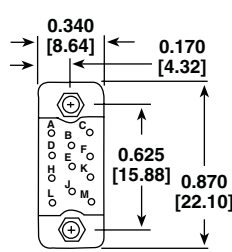

11 CONTACTS

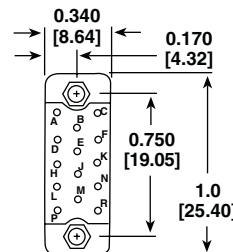

14 CONTACTS



20 CONTACTS



26 CONTACTS

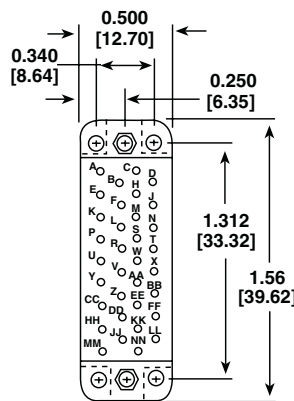

34 CONTACTS

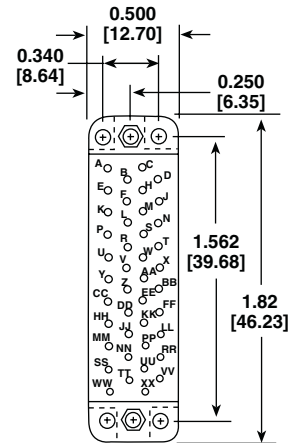

42 CONTACTS



50 CONTACTS

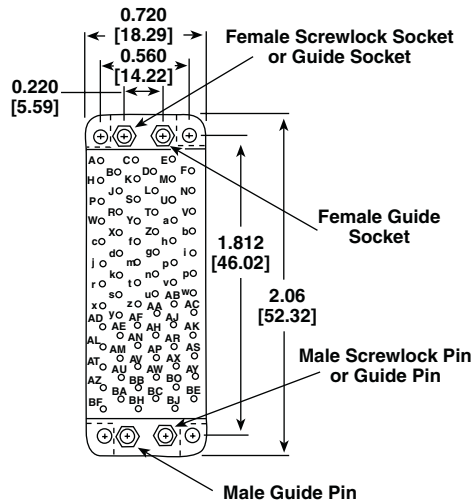

75 CONTACTS

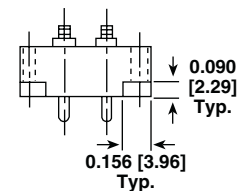
 TYPICAL END VIEW
34 THRU 50 CONTACTS

 TYPICAL END VIEW
75 CONTACTS

PANEL CUTOUT in inches [millimeters]								
		NUMBER OF CONTACTS	A	B	C	D	FIGURE	
<p>FIGURE I</p>	<p>FIGURE II</p>	<p>FIGURE III</p>	5	0.230 [5.84]	0.531 [13.49]	0.410 [10.41]	-	I
			7	0.230 [5.84]	0.625 [15.88]	0.500 [12.70]	-	
			11	0.340 [8.64]	0.625 [15.88]	0.530 [13.46]	-	
			14	0.340 [8.64]	0.750 [19.05]	0.620 [15.75]	-	
			20	0.340 [8.64]	1.0 [25.40]	0.910 [23.11]	-	
			26	0.340 [8.64]	1.25 [31.75]	1.16 [29.46]	-	
			34	0.500 [12.70]	1.312 [33.32]	1.16 [29.46]	0.343 [8.71]	
42	0.500 [12.70]	1.562 [39.68]	1.41 [35.81]	0.343 [8.71]				
50	0.500 [12.70]	1.812 [46.02]	1.66 [42.16]	0.343 [8.71]				
75	0.720 [18.29]	1.812 [46.02]	1.66 [42.16]	0.562 [14.28]	III			

ORDERING INFORMATION								
C	SM	B	S	20	G	26	R	027 ⁽¹⁾
CONTACTS	MODEL	CONTACT TYPE	CONTACT STYLE	CONTACT SIZE	PLATING	NUMBER OF CONTACTS	(OPTIONAL)	HARDWARE OPTIONS
	Subminiature		P = Pin S = Socket	#20 AWG		5, 7, 11, 14, 20, 26, 34, 42, 50, 75		
(OPTIONAL) Closed entry socket contacts only. Omit for standard contacts.					Optional plating available: G = Gold (0.00003 thick) over nickel G5 = Gold (0.00005 thick) over nickel Omit designator for gold (0.00001 thick) over nickel		(OPTIONAL) R = Reversed guides or screwlocks Omit for standard	
		(OPTIONAL) B = Beryllium copper, socket contacts (Solder cup) D = Dip solder contacts						(Omit if no hardware desired) 027 = Slotted cres guides 0.090" [2.29 mm] diameter SK = Turnable screwlocks with 2-56 threads SK3 = Turnable screwlocks with 3-48 threads SL = Fixed screwlocks with 2-56 threads SL3 = Fixed screwlocks with 3-48 threads SK030 = Turnable screwlocks with short slotted knobs SK035 = Turnable screwlocks with socket head knobs SK3030 = Turnable screwlocks with short slotted knobs with 3-48 threads SK3035 = Turnable screwlocks with socket head knobs with 3-48 threads
EXAMPLES: SMBS20-26SK035 = Female, 26 beryllium copper socket contacts with socket head knobs on turnable screwlocks for #20 AWG wiring. SMP20-14SL3 = Male, 14 contact pins, fixed screwlocks with 3-48 threads for #20 AWG wiring.								

Note

⁽¹⁾ To order complete connector with hardware supplied unassembled, add suffix "UA" on end of hardware designation.



Disclaimer

ALL PRODUCT, PRODUCT SPECIFICATIONS AND DATA ARE SUBJECT TO CHANGE WITHOUT NOTICE TO IMPROVE RELIABILITY, FUNCTION OR DESIGN OR OTHERWISE.

Vishay Intertechnology, Inc., its affiliates, agents, and employees, and all persons acting on its or their behalf (collectively, "Vishay"), disclaim any and all liability for any errors, inaccuracies or incompleteness contained in any datasheet or in any other disclosure relating to any product.

Vishay makes no warranty, representation or guarantee regarding the suitability of the products for any particular purpose or the continuing production of any product. To the maximum extent permitted by applicable law, Vishay disclaims (i) any and all liability arising out of the application or use of any product, (ii) any and all liability, including without limitation special, consequential or incidental damages, and (iii) any and all implied warranties, including warranties of fitness for particular purpose, non-infringement and merchantability.

Statements regarding the suitability of products for certain types of applications are based on Vishay's knowledge of typical requirements that are often placed on Vishay products in generic applications. Such statements are not binding statements about the suitability of products for a particular application. It is the customer's responsibility to validate that a particular product with the properties described in the product specification is suitable for use in a particular application. Parameters provided in datasheets and / or specifications may vary in different applications and performance may vary over time. All operating parameters, including typical parameters, must be validated for each customer application by the customer's technical experts. Product specifications do not expand or otherwise modify Vishay's terms and conditions of purchase, including but not limited to the warranty expressed therein.

Except as expressly indicated in writing, Vishay products are not designed for use in medical, life-saving, or life-sustaining applications or for any other application in which the failure of the Vishay product could result in personal injury or death. Customers using or selling Vishay products not expressly indicated for use in such applications do so at their own risk. Please contact authorized Vishay personnel to obtain written terms and conditions regarding products designed for such applications.

No license, express or implied, by estoppel or otherwise, to any intellectual property rights is granted by this document or by any conduct of Vishay. Product names and markings noted herein may be trademarks of their respective owners.

Компания «Life Electronics» занимается поставками электронных компонентов импортного и отечественного производства от производителей и со складов крупных дистрибьюторов Европы, Америки и Азии.

С конца 2013 года компания активно расширяет линейку поставок компонентов по направлению коаксиальный кабель, кварцевые генераторы и конденсаторы (керамические, пленочные, электролитические), за счёт заключения дистрибьюторских договоров

Мы предлагаем:

- Конкурентоспособные цены и скидки постоянным клиентам.
- Специальные условия для постоянных клиентов.
- Подбор аналогов.
- Поставку компонентов в любых объемах, удовлетворяющих вашим потребностям.
- Приемлемые сроки поставки, возможна ускоренная поставка.
- Доставку товара в любую точку России и стран СНГ.
- Комплексную поставку.
- Работу по проектам и поставку образцов.
- Формирование склада под заказчика.
- Сертификаты соответствия на поставляемую продукцию (по желанию клиента).
- Тестирование поставляемой продукции.
- Поставку компонентов, требующих военную и космическую приемку.
- Входной контроль качества.
- Наличие сертификата ISO.

В составе нашей компании организован Конструкторский отдел, призванный помогать разработчикам, и инженерам.

Конструкторский отдел помогает осуществить:

- Регистрацию проекта у производителя компонентов.
- Техническую поддержку проекта.
- Защиту от снятия компонента с производства.
- Оценку стоимости проекта по компонентам.
- Изготовление тестовой платы монтаж и пусконаладочные работы.



Тел: +7 (812) 336 43 04 (многоканальный)

Email: org@lifeelectronics.ru