

Altech Corp.®

Quality System



Quality Endorsed Company

22 & 30mm
Push Buttons,
Selector Switches
& LED Pilot Lights

High Quality Metal
and Long Life LEDs



Altech Corp. can provide other push button and actuator options. If your requirement calls for a 22 mm operator which is not shown, please do not hesitate to call.

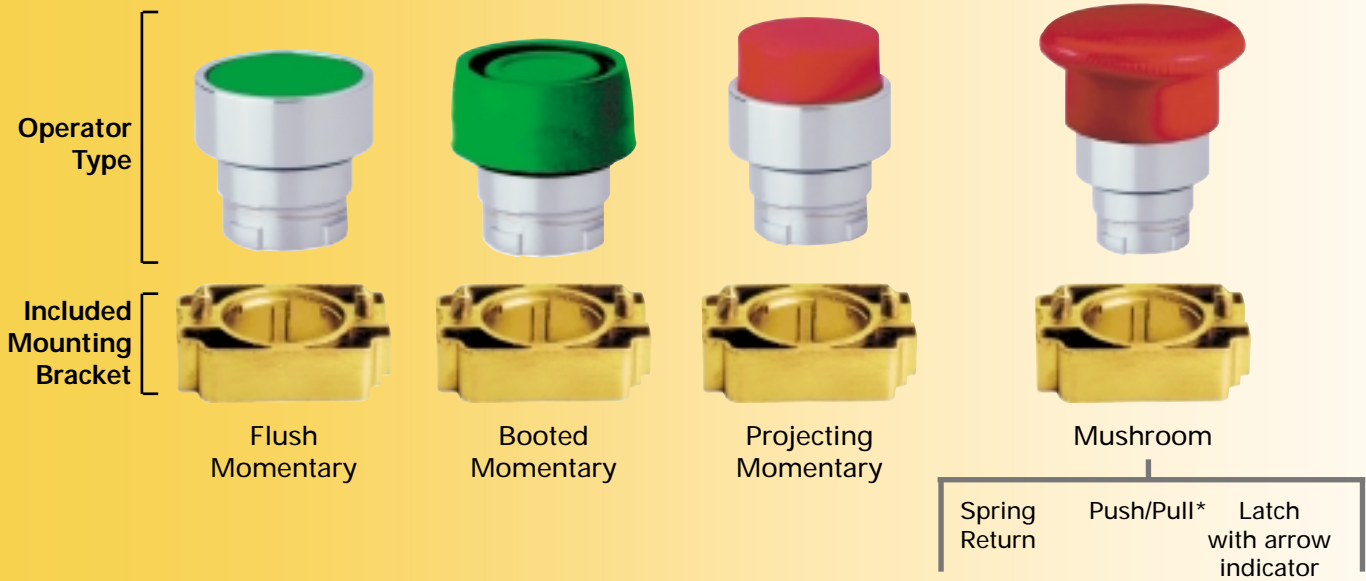

Push buttons

Color	Cat. No.	Cat. No.	Cat. No.	Cat. No.
White	2AF1	2AB1	2AP1	2AM2
Black	2AF2	2AB2	2AP2	2AM3
Green	2AF3	2AB3	2AP3	2AM4
Red	2AF4	2AB4	2AP4	2AM6
Blue	2AF6	2AB6	2AP6	2AM8
Yellow	2AF8	2AB8	2AP8	
				2AMPP2
				2AMPP4
				2AML2
				2AML4

For push button and selector switch dimensions see page 7.

*Illuminated available, please contact Altech.



Switch Contacts

- Panel Mount**
- Normally Open Silver S1
 - Normally Closed Silver S2
 - Normally Open Gold S3
 - Normally Closed Gold S4

Base Mount

(for use with thermoplastic enclosures listed on page 5)

- Normally Open Silver S5
- Normally Closed Silver S6
- Normally Open Gold S7
- Normally Closed Gold S8



Certified for type 4X, 12 environment.

S2 normally closed contact shown.

S1 normally open contact shown.



Notes:

Up to six switch contacts can be installed on any non illuminated operator.

Up to four switch contacts can be installed on any illuminated operator.

22mm Non Illuminated Metal Operators

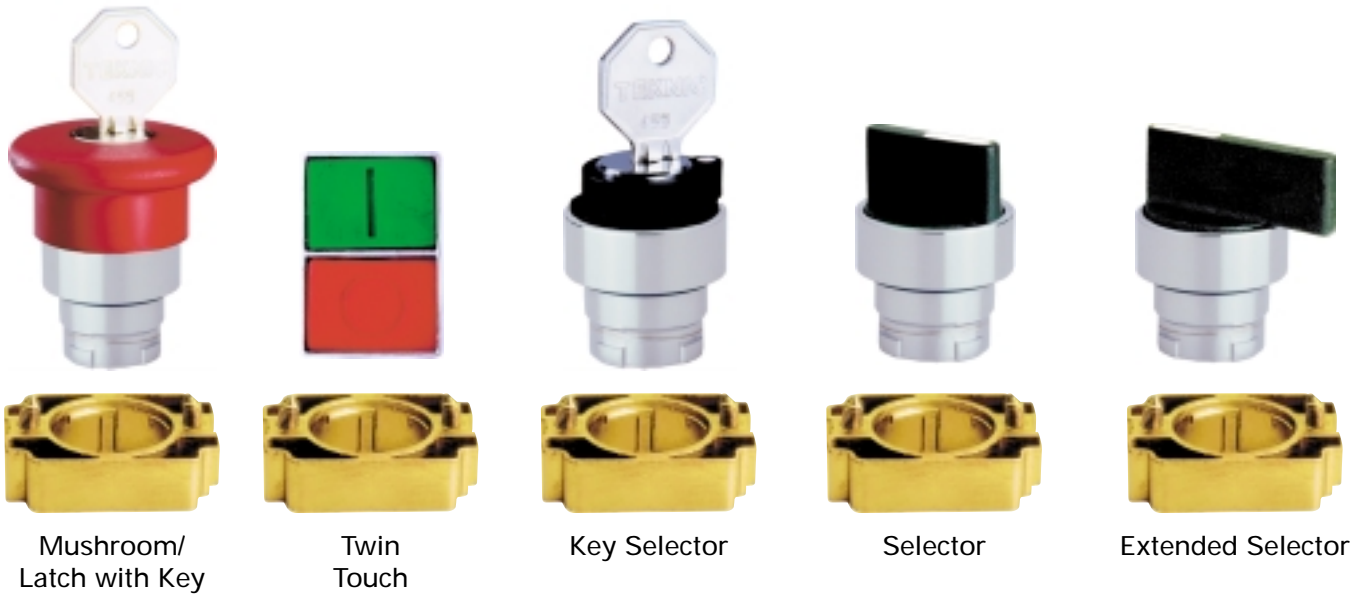

Push buttons

Selector Switches

Cat. No.

Cat. No.

Cat. No.

Cat. No.

Cat. No.

■ 2AMLKB2



Green/Red
2ATF3-F4-IO

■ 2AMLKB4

Green/ ExtendedRed
2ATF3P4

■ 2AK2-XX

■ 2AS2-X

■ 2AS2E-X

Key
Selector

2 A K 2 -

Function Codes

Key Removal

Ser. No.	Function	Left	Center	Right
01	Maintained	✓		✓
02	Maintained	✓		
03	Maintained			✓
04	Spring Return	✓		
05	Maintained	✓		✓
06	Maintained	✓	✓	✓
07	Maintained		✓	
08	Spring Return		✓	
09	Spring Return		✓	
10	Spring Return		✓	

Non
Illuminated
Selector

2 A S 2 -

Function Codes

Ser. No.	Function
1	Maintained
2	Spring Return
3	Maintained
4	Spring Return
5	Spring Return
6	Spring Return

Non Illuminated
Extended
Selector

2 A S 2 E -

Function Codes

Ser. No.	Function
1	Maintained
2	Spring Return
3	Maintained
4	Spring Return
5	Spring Return
6	Spring Return

22mm LED Illuminated Operators & Pilot Lights

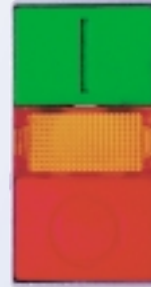

Included LED Bulb, Bulb Holder, Mounting Hardware



Selector



Projecting Momentary



Flush Momentary



Twin Touch



LED Pilot Light

Selector Switch

Push buttons

LED Pilot Lights

Color	Cat. No.	Cat. No.	Cat. No.	Cat. No.	Cat. No.
White	2ASL1LB-X-XXX	2ALP1LB-XXX	2ALF1LB-XXX	Green/Red 2ATL5LB F3F4-XXX	2PLB1LB-XXX
Green	2ASL3LB-X-XXX	2ALP3LB-XXX	2ALF3LB-XXX		2PLB3LB-XXX
Red	2ASL4LB-X-XXX	2ALP4LB-XXX	2ALF4LB-XXX	2PLB4LB-XXX	
Amber	2ASL5LB-X-XXX	2ALP5LB-XXX	2ALF5LB-XXX	2PLB5LB-XXX	
Blue	2ASL6LB-X-XXX	2ALP6LB-XXX	2ALF6LB-XXX	2PLB6LB-XXX	
Clear*	2ASL7LB-X-XXX*	2ALP7LB-XXX*	2ALF7LB-XXX*	2PLB7LB-XXX*	
Yellow	2ASL8LB-X-XXX	2ALP8LB-XXX	2ALF8LB-XXX	2PLB8LB-XXX	

*Supplied with yellow LED

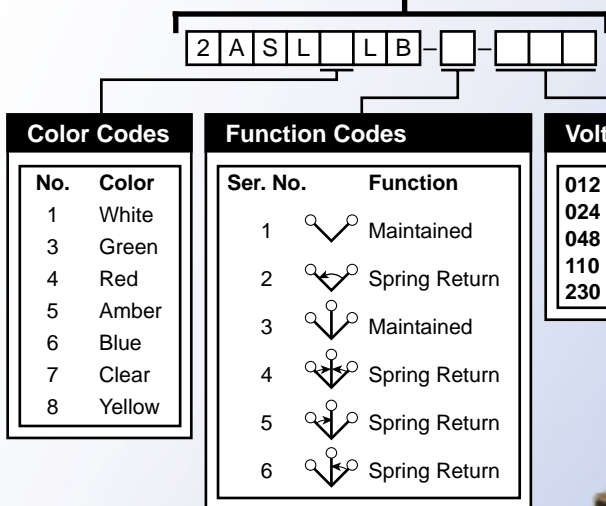

Note:
All LED pilot lights and illuminated actuators at a specified voltage will operate on either AC or DC.

Voltage Codes	
012	= 12VAC/DC
024	= 24VAC/DC
048	= 48VAC/DC
110	= 110VAC/DC
230	= 230VAC/DC

All illuminated operators and pilot lights are supplied with LED.

Notes:
Up to four switch contacts can be installed on any illuminated operator.

Up to six switch contacts can be installed on any non illuminated operator.

For push button and selector switch dimensions see page 7.



Certified for type 4X, 12 environment.

22mm Enclosures

For use with
panel mount
switch contacts

For use with
base mount
switch contacts

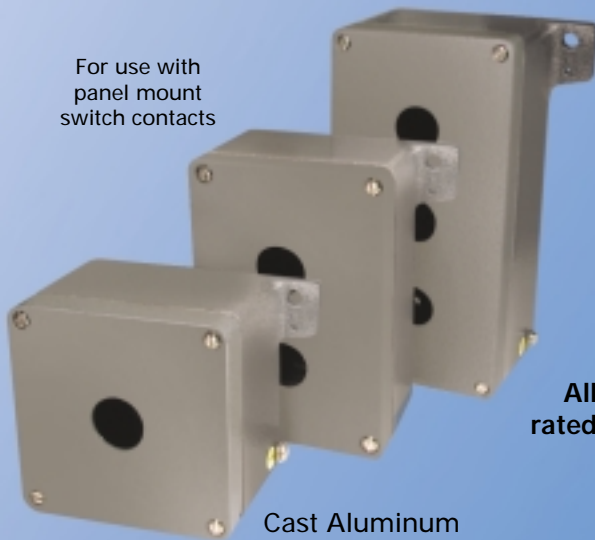

Cast Aluminum
Series

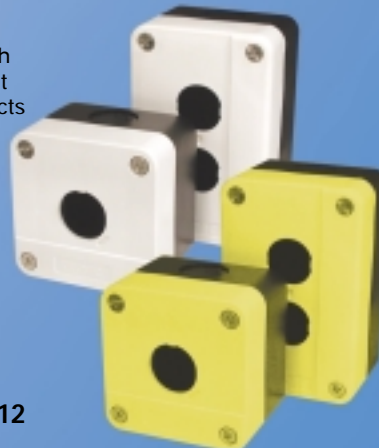

Thermoplastic
Series



All enclosures
rated NEMA 4X, 12

Cat. No.	Operator Capacity	Color Top/ Bottom	Construction	Dimensions (LxWxH) mm*	Cable Entry Size	No. of Knockouts	Mounting Hole Dia.
2-004-A-12	1	Gray	Cast Aluminum	70 x 90 x 90	1 x M20 x 1.5mm	-	8 mm
2-005-C-12	2	Gray	Cast Aluminum	70 x 90 x 135	2 x M20 x 1.5mm	-	8 mm
2-006-E-12	3	Gray	Cast Aluminum	70 x 90 x 180	2 x M20 x 1.5mm	-	8 mm
2-004-A-12	1	Gray	Cast Aluminum	52 x 80 x 90	2 x M20 x 1.5mm	-	6 mm
2-005-C-12	2	Gray	Cast Aluminum	52 x 80 x 135	2 x M20 x 1.5mm	-	6 mm
2-006-E-12	3	Gray	Cast Aluminum	52 x 80 x 180	2 x M20 x 1.5mm	-	6 mm
3-001-Q-11	1	White/ Black	Thermoplastic	50.5 x 68 x 68	2 x 21mm	2	-
4-001-Q-10	1	Yellow/ Black	Thermoplastic	50.5 x 68 x 68	2 x 21mm	2	-
3-001-R-11	2	White/ Black	Thermoplastic	50.5 x 68 x 104	2 x 21mm	2	-
4-001-R-10	2	Yellow/ Black	Thermoplastic	50.5 x 68 x 104	2 x 21mm	2	-

* To convert mm to inches, divide mm by 25.4.
Dimensions for metal enclosures do not include mounting ears.

Custom assemblies available.

Contact Altech for custom imprinting, enclosure color options, custom legend plates and prewired push button stations.

E-Stop Shroud for 22 mm

Cat. No.	Construction
2ESS1	Polimer Plastic
2ESS1-UL	UL Plastic

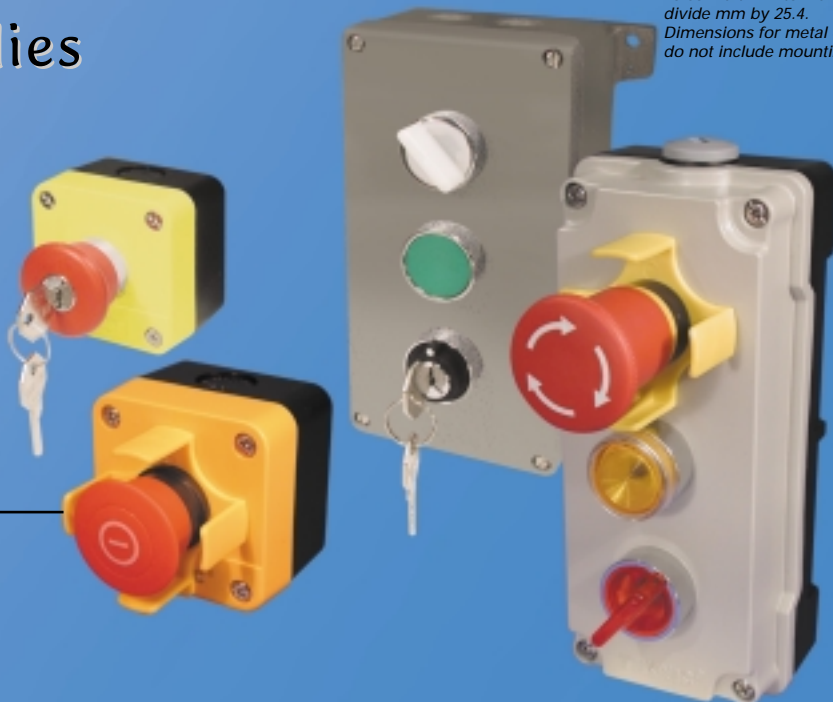

22mm LED Illuminated Operators & Pilot Lights

Control and Signalling devices Ø 22.5

This range of Ø 22.5 push buttons, selector switches, illuminated switches, illuminated selector switches and pilot lights have been designed to provide the following salient features:

- Economy of space
- Self Wiping Contact
- Safe in operation
- Simple to mount (screw driver is all that is required)
- Fixing method unaffected by excessive vibration-unit does not rotate
- Protection against electric shock (unit grounded)
- Aesthetically pleasing
- Heavy duty construction
- Shrouded terminals
- Very good flame resistance
- Use of LEDs for long life and minimum maintenance

Actuators

The circular actuators have chrome plated metal bezels, and are interchangeable on the different types of contact elements.

Contact Elements

The contact elements are double break and have self wiping contacts. The elements are interchangeable and can be stacked without additional hardware. 1 to 6 elements (NO or NC) can be used with non illuminated actuators, whereas, 1 to 4 elements (NO or NC) can be used for illuminated actuators. Gold plated NO and NC contact elements for low voltage, low current switching circuits < 25 mA, are available.

LED Illuminated Actuators and Pilot Lights

LED illuminated actuators & pilot lights are supplied, LED in bayonet cap suitable for operating at various voltages. LED bulbs with bayonet cap are constructed in the standard BA9S design with OAL max. 28 mm.

Terminals

Contact elements and pilot lights are designed to have shrouded terminals with combination flat/phillip screws.

Fixing

The control devices Ø 22.5 can be fixed in any position on panels of 1 to 6 mm (.039 - .236 in.) thickness. We recommend minimum fixing centers of 30 x 40 mm (1.2 x 1.57"). However, the dimensions and configuration should be decided on the basis of the application. The actuators and the lens assemblies lock on to the holding bracket using a bayonet type of fixing which enables a simple and fast assembly. The complete assembly is locked into position on the panel by two M4 pointed screws on the bracket, tightened equally from the rear. The screws should be tightened adequately to such an extent as to pierce through the paint on the panel from inside. These screws also ensure the grounding of the unit.

Electrical and Mechanical Characteristics Environment

Standard conformity:

Approvals:

Degree of protection:

Ambient :

Operating position:

Contact Block

Rated insulation voltage:

Rated thermal current:

Contact operation:

Make and break capacity

as per IEC 947 - 5 - (1) 1990:

As per CSA - C22.2 No. 14-95, UL508:

Terminal capacity:

Terminal marking:

Short circuit protection:

Mechanical life:

Electric rating (for 1 million operation cycles, operation at 3600 cycles per hour, load factor 0.5)

Modules for pilot light & illuminated switches with bulb LED

Current consumption (applicable to all colors)

24 VAC/DC, 100 VAC & 240 VAC:

110 VDC:

220 VDC:

Service life (at nominal voltage and at ambient temperature of 25°C):

Voltage limits (nominal voltage):

Short circuit protection:

Terminal capacity:

IEC 60947-5-1

VDE0660

CSA - C22.2 No. 14-95, UL508, IEC 947 - 5 (1) 1990, IS 13947

ASTA UK certified as per IEC 947 - 5 - (1) 1990

CSA - C22.2 No. 14-95, UL508

IP 65 as per IEC 529, NEMA 4X, 12 as per UL 508

- 25°C to + 70°C

All positions

500V

10A

Self wiping, slow break NO or NC

AC 15 4A, 415V AC

DC 13 0.5A, 110V DC

A600 Q600

minimum 1 x 0.5 mm² (20 AWG), maximum 2 x 1.5² mm² (2x16 AWG) or 1 x 2.5 mm² (1x14 AWG)

1-2 for NC, 3-4 for NO

10A cartridge fuse HRC type, rated for resistive loading

Over 1 million operations

	V	24	120	230		V	24	110
AC 15	A	5	4	3	DC 13	A	0.5	0.2

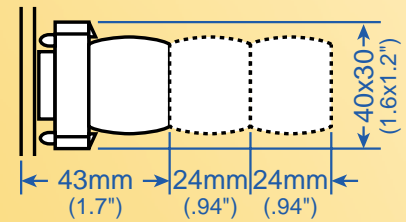

Fixing Arrangement

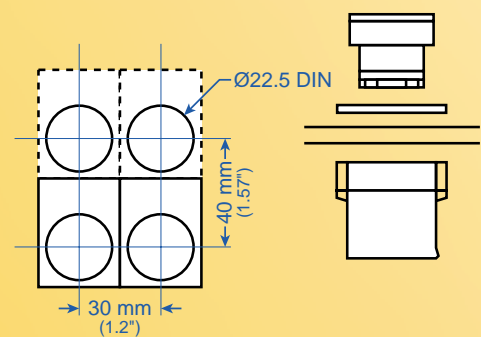

22mm LED Illuminated Operators & Pilot Lights

Accessories and Spares

Legend plates 30 x 40 mm (1.2 x 1.6") (black with white characters) are supplied with the following standard texts:

START 2LP01	FORWARD 2LP03	UP 2LP05	OPEN 2LP07	AUTO 2LP09	SLOW 2LP11	RESET 2LP13	ON 2LP15	RIGHT 2LP17	TRIP 2LP19
STOP 2LP02	REVERSE 2LP04	DOWN 2LP06	CLOSE 2LP08	HAND 2LP10	FAST 2LP12	INCH 2LP14	OFF 2LP16	LEFT 2LP18	POWER ON 2LP20
START/STOP 2LP28	UP/DOWN 2LP29	ON/OFF 2LP30	REV/FWD 2LP31	AUTO/HAND 2LP32	LOCAL/REMOTE 2LP33	I/II 2LP34	O/I 2LP35		
HAND/O/AUTO 2LP36	SLOW/OFF/FAST 2LP37	UP/OFF/DOWN 2LP38	I/O/II 2LP39	BLANK 2LP40	EMERGENCY STOP 2LP41				

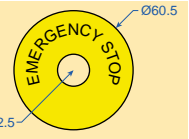
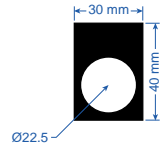

Custom Legends per customer specifications - 2LPXX

Legend plate Ø 60 mm
yellow with black characters
for EMERGENCY STOP.

Lenses and Replacement Boots

Color	White	Green	Red	Amber	Blue	Clear	Yellow
Lenses for pilot lights with LED	2PLL1L	2PLL3L	2PLL4L	2PLL5L	2PLL6L	2PLL7L	2PLL8L
Lenses for illuminated actuators with LED (flush/projecting)	2LAL1L	2LAL3L	2LAL4L	2LAL5L	2LAL6L	2LAL7L	2LAL8L
Boots for booted actuators	2BT2	2BT3	2BT4	-	2BT6	-	2BT8

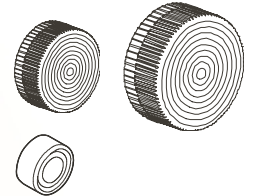

Replacement LED Bulbs

Color	White	Green	Red	Amber	Blue	Yellow	Voltage
Type No.	MCB9124	MCB9324	MCB9424	MCB9524	MCB9624	MCB9824	24
	MCB91110	MCB93110	MCB94110	MCB95110	MCB96110	MCB98110	110
	MCB91230	MCB93230	MCB94230	MCB95230	MCB96230	MCB98230	230

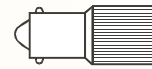

Push Push mechanism for converting spring return actuator into maintained

Type No.: 2PPM

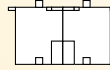

Adapter for fixing Ø 22.5 devices in Ø 30.5 cutout

Type No.: 2ADP

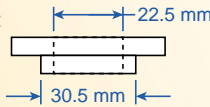

Mounting Bracket

Type No.: 2BRK



Type No.: 2BKKT (Thin Bracket for Plastic Enclosure)

Padlock

For mushroom actuator: Type No.: 2PAM
For projecting actuator: Type No.: 2PAP

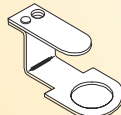

Transparent Silicone Rubber Boot for Flush Actuators

Color: Clear

Type No.: 2BT7



Rubber Boot for Twin Actuator

Color: Clear

Type No.: 2ATBT7 (non illuminated)

2ATLBT7 (illuminated)



Blanking plug for 22.5 mm holes

Color: Black

Type No.: 2BP2

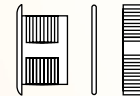

Bulb Extractor

Type No.: 2BA9SE

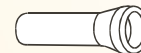

Push button Diagrams (to convert to inches multiply by 0.03937)

Non-Illuminated Flush

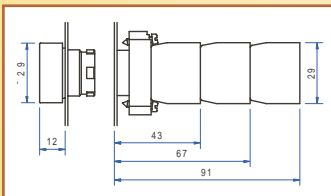

Non-Illuminated Projecting

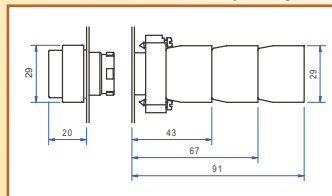

Non-Illuminated Mushroom

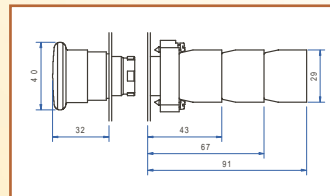

Non-Illuminated Key Mushroom

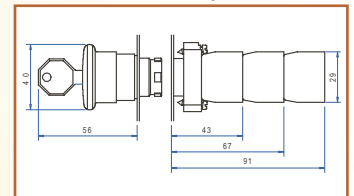

Non-Illuminated Double Head Flush

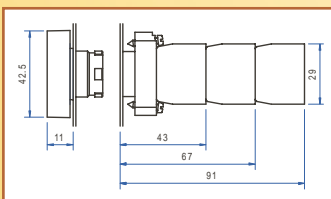

Non-Illuminated Key Selector

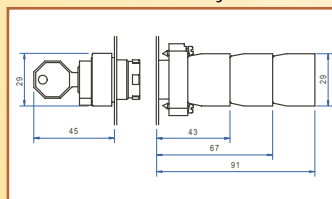

Non-Illuminated Selector & Extended

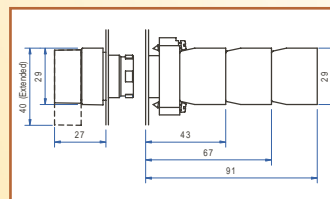

Pilot Light

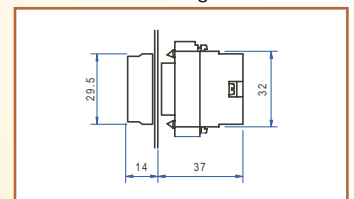

Illuminated Selector

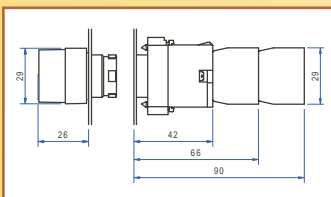

Illuminated Projecting

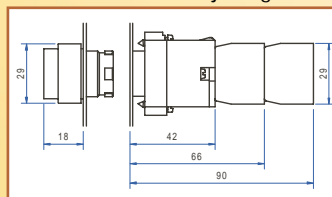

Illuminated Flush

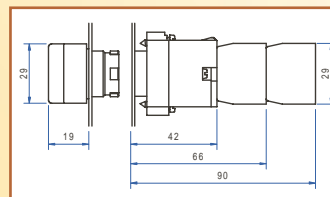

Illuminated Double Head Flush

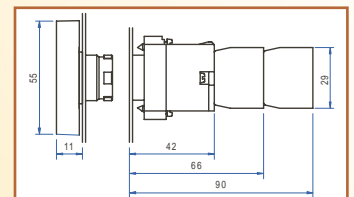

30 mm Push Buttons



Flush
Non Illuminated
Momentary



Flush
Illuminated
Momentary



Booted
Momentary



Projecting
Momentary



Selector
Maintained
Momentary

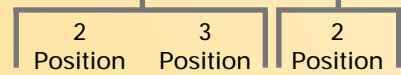
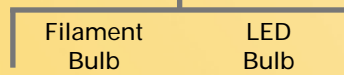

Color	Cat. No.	Cat. No.	Cat. No.	Cat. No.	Cat. No.	Cat. No.	Cat. No.	Cat. No.
White	AF1	ALF1-XXX	ALF1LB-XXX	AB1	AP1	AS2-2P	AS2-3P	AS2-2PSR
Black	AF2			AB2	AP2			
Green	AF3	ALF3-XXX	ALF3LB-XXX	AB3	AP3			
Red	AF4	ALF4-XXX	ALF4LB-XXX	AB4	AP4			
Amber		ALF5-XXX	ALF5LB-XXX					
Blue	AF6	ALF6-XXX	ALF6LB-XXX	AB6	AP6			
Clear*		ALF7-XXX	ALF7LB-XXX*					
Yellow	AF8	ALF8-XXX	ALF8LB-XXX	AB8	AP8			

* ALF7LB-XXX supplied with yellow LED

Note:
All LED pilot lights and illuminated actuators at a specified voltage will operate on either AC or DC.

Voltage Codes	
024	= 24V AC/DC
048	= 48V AC/DC
110	= 110V AC/DC
230	= 230V AC/DC



Certified for type 4X, 12 environment.

Note:
Up to 4 contact blocks may be installed on any non illuminated actuator. This will give the user up to 4 NO and 4 NC contacts. With an illuminated actuator (ALF series), 2 contact blocks may be installed.

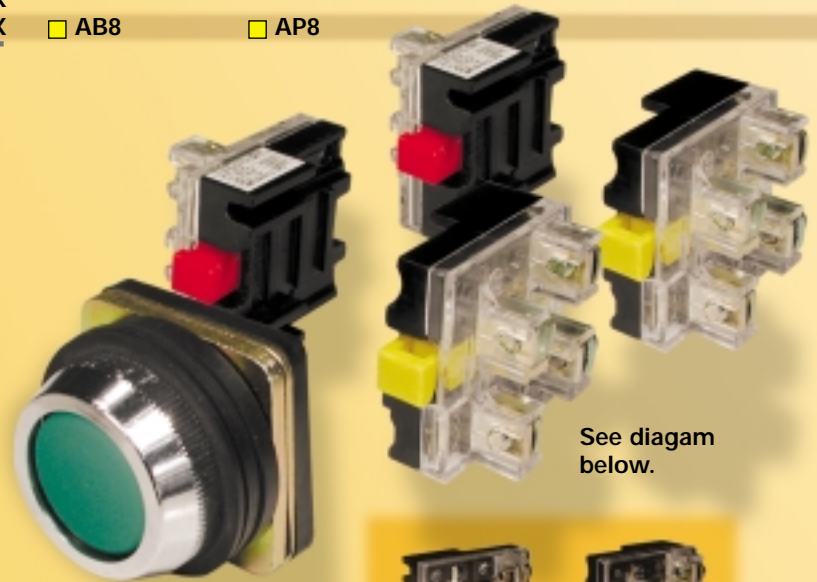

See diagram below.



S11

S12

30 mm Contact Elements

Description	Cat. No.
1 Normally Open + 1 Normally Closed Silver Contacts	S11
2 Normally Open + 2 Normally Closed Silver Contacts	S11 + S12

For additional contacts, see diagram at right.

* When using more than two contacts additional screws need to purchased separately (SC45 and SC90).

Contact Installation Screws		
Type	Dimensions	Used with
SC25	M4 x 25 mm	S11
SC45	M4 x 45 mm	S12, S11 + S12
SC65	M4 x 65 mm	2x S11 + S12
SC90	M4 x 90 mm	2x S11 + 2x S12

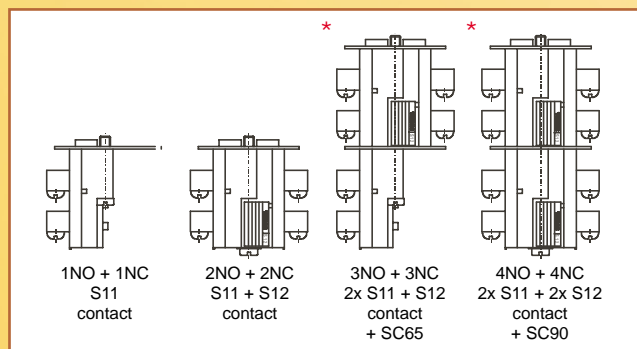

30 mm Push Buttons



Mushroom with Key



Mushroom with Indicating Arrows

Press to Lock,
Turn to Release



Mushroom Momentary



Key

Press to Lock, Key to Release Key to Lock, Key to Release

Cat. No.

Cat. No.

Cat. No.

Cat. No.

Cat. No.

■ AMLKB2

■ AMKB2

■ AML2

□ AM1

■ AM2

■ AK2-XXXXX

■ AMLKB4

■ AMKB4

■ AML4

■ AM3

■ AM4

■ AM6

■ AM8

Characteristics

Environment

Ambient Temperature	Storage	deg C	-25 to +70
Degrees of Protection	Conforming to IEC 529		IP65
Mechanical Life in millions of operating cycles	All push buttons except maintained mushroom		1
	maintained mushroom		0.3

Mechanical Characteristics of contact elements

Contact Operation	NC+NO	Double break, self wiping
Rated Insulation Voltage	500 V AC	
Operating Travel	Push buttons	Changing NC state 2.4mm Changing NO state 4.3mm Travel 8.7mm
Terminal Capacity	Cablings	2x1.5 sq.mm (2x16 AWG) or 1x2.5 sq.mm (14 AWG)
Contact Material	Bimetal (Cu/Ag)	Standard single element
Short Circuit Protection	Conforming to IS6875-II	10A HRC fuse
Rated Make Break	UL508, A600 Q600, ratings	standard block with screw clamp terminals 415V, 10A standard block with screw clamp terminals 220V, 2A
Dielectric Strength	Push Buttons, Pilot Lights	2500V for 1 minute

A K 2 - [] [] [] [] [] []

Function Codes

Ser. No.	Function
2PB	Maintained
2POSR	Momentary
2PI	Maintained
2PO	Maintained
3PB	Maintained
3PC	Maintained

Key Removal

Function
Both Positions
Left Position
Right Position
Left Position
Left and Right Position
Center Position



Certified for type 4X, 12 environment.

Note:
All LED pilot lights and illuminated actuators at a specified voltage will operate on either AC or DC.



Pilot Lights

Color

Filament Cat. No.

LED Cat. No.

- [X] [X] [X]

- White
- Green
- Red
- Amber
- Blue
- Clear
- Yellow

- PLB1-XXX
- PLB3-XXX
- PLB4-XXX
- PLB5-XXX
- PLB6-XXX
- PLB7-XXX
- PLB8-XXX

- PLB1LB-XXX
- PLB3LB-XXX
- PLB4LB-XXX
- PLB5LB-XXX
- PLB6LB-XXX
- PLB7LB-XXX*
- PLB8LB-XXX

Voltage Codes

024	= 24VAC/DC
048	= 48VAC/DC
110	= 110VAC/DC
230	= 230VAC/DC

* supplied with yellow LED

30 mm Push Buttons and LED Pilot Lights

Accessories and Spares

Legend plates 30 x 40 mm (1.2 x 1.6") (black with white characters) are supplied with the following standard texts:

START LP01	FORWARD LP03	UP LP05	OPEN LP07	AUTO LP09	SLOW LP11	RESET LP13
ON LP15	RIGHT LP17	TRIP LP19	STOP LP02	REVERSE LP04	DOWN LP06	CLOSE LP08
HAND LP10	FAST LP12	INCH LP14	OFF LP16	LEFT LP18	POWER ON LP20	



Legend plate 60mm diameter yellow with black characters for EMERGENCY STOP

Padlock

For mushroom actuator:
For projecting actuator:

Type No.: PAM
Type No.: PAP

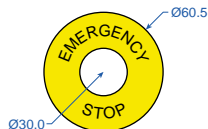

Type
LP41

Lenses and Replacement Boots

Color	Trans/White	Green	Red	Amber	Blue	Clear	Yellow
Lenses for pilot lights	PLL1	PLL3	PLL4	PLL5	PLL6	PLL7	PLL8
Lenses for illuminated actuators	ALL1	ALL3	ALL4	ALL5	ALL6	ALL7	ALL8

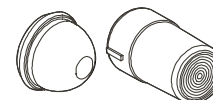

Rubber Boots for Booted Actuators

Color	White	Black	Green	Red	Blue	Yellow
Boot	BT1	BT2	BT3	BT4	BT6	BT8



Spare LED Bulbs

Color	24V AC/DC	48V AC/DC	110V AC/DC	230V AC/DC
White	MCB15124	MCB15148	MCB151110	MCB151230
Green	MCB15324	MCB15348	MCB153110	MCB153230
Red	MCB15424	MCB15448	MCB154110	MCB154230
Amber	MCB15524	MCB15548	MCB155110	MCB155230
Blue	MCB15624	MCB15648	MCB156110	MCB156230
Yellow	MCB15824	MCB15848	MCB158110	MCB158230

Bulb Extractor

Type No.: 2BA9SE

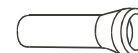

Spare Filament Bulbs

24V AC/DC	48V AC/DC	110V AC/DC	230V AC/DC
BA15D24	BA15D48	BA15D110	BA15D230

Contact Block Installation Screws

Type	Dimensions	used with
SC25	M4 x 25 mm	S11 only
SC45	M4 x 45 mm	S12, S11 + S12 (2NO + 2NC)
SC65	M4 x 65 mm	2 x S11 + S12 (3NO + 3NC)
SC90	M4 x 90 mm	2 x S11 + 2 x S12 (4NO + 4NC)

30mm Enclosures

Cast Aluminum Series



All enclosures
rated NEMA 4X, 12

Cat. No.	Operator Capacity	Color Top/ Bottom	Construction	Dimensions (LxWxH) mm*	Cable Entry Size	Mounting Hole (Dia.)
1-002-A-12	1	Gray	Cast Aluminum	70 x 90 x 90	1 x M20 x 1.5 mm	8 mm
1-003-C-12	2	Gray	Cast Aluminum	70 x 90 x 135	2 x M20 x 1.5 mm	8 mm
1-004-E-12	3	Gray	Cast Aluminum	70 x 90 x 180	2 x M20 x 1.5 mm	8 mm

* To convert mm to inches, divide mm by 25.4.

30 mm Push Button Diagrams

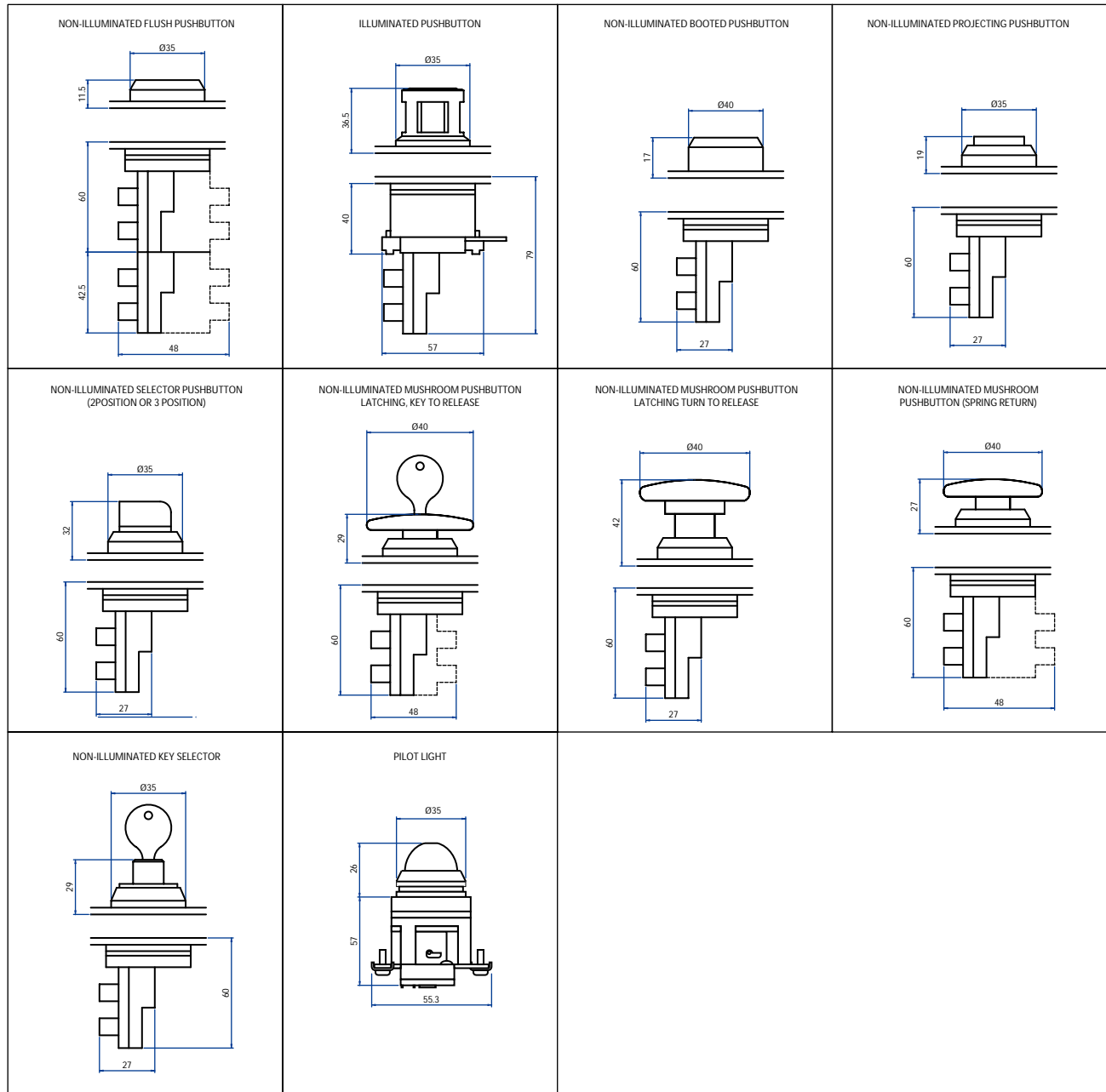

(to convert to inches multiply by 0.03937)

Altech Corp.[®] Serving the Automation & Control Industry Since 1984
ISO9001 Certified

Product Categories:

- Circuit Breakers
- Disconnect Switches
- Enclosures
- Foot Switches
- European Fuses
- Interface Modules
- Liquid Tight Strain Reliefs
- Pin & Sleeve Devices
- PCB Terminal Blocks
- Push Buttons
- Safety Relays
- Sensors
- Terminal Blocks
- Wire Ducts
- Distribution Blocks
- Receptacles
- Eurostrips
- Ferrules & Tools

Navigation: News, Online Catalogs, Part No. Search, Dealer Locator, Contact, Private, SPECIALS, ORDER ONLINE

PRODUCT LINES

- Miniature Circuit Breakers
- DIN Enclosures
- Electronic Enclosures
- European Fuses
- Foot Switches
- Inductive Proximity Sensors
- Industrial Enclosures
- Interface Modules
- Liquid Tight Strain Reliefs
- Metal Detection Systems
- Motor Disconnect Switches
- Pin and Sleeve Devices
- Push Buttons
- Safety Relays
- Terminal Blocks
- Safety Relays

Altech Corporation
35 Royal Road
Flemington, NJ 08822-6000
Phone (908) 806-9400
Fax (908) 806-9490
www.altechcorp.com

Компания «Life Electronics» занимается поставками электронных компонентов импортного и отечественного производства от производителей и со складов крупных дистрибьюторов Европы, Америки и Азии.

С конца 2013 года компания активно расширяет линейку поставок компонентов по направлению коаксиальный кабель, кварцевые генераторы и конденсаторы (керамические, пленочные, электролитические), за счёт заключения дистрибьюторских договоров

Мы предлагаем:

- Конкуренеспособные цены и скидки постоянным клиентам.
- Специальные условия для постоянных клиентов.
- Подбор аналогов.
- Поставку компонентов в любых объемах, удовлетворяющих вашим потребностям.
- Приемлемые сроки поставки, возможна ускоренная поставка.
- Доставку товара в любую точку России и стран СНГ.
- Комплексную поставку.
- Работу по проектам и поставку образцов.
- Формирование склада под заказчика.
- Сертификаты соответствия на поставляемую продукцию (по желанию клиента).
- Тестирование поставляемой продукции.
- Поставку компонентов, требующих военную и космическую приемку.
- Входной контроль качества.
- Наличие сертификата ISO.

В составе нашей компании организован Конструкторский отдел, призванный помогать разработчикам, и инженерам.

Конструкторский отдел помогает осуществить:

- Регистрацию проекта у производителя компонентов.
- Техническую поддержку проекта.
- Защиту от снятия компонента с производства.
- Оценку стоимости проекта по компонентам.
- Изготовление тестовой платы монтаж и пусконаладочные работы.



Тел: +7 (812) 336 43 04 (многоканальный)

Email: org@lifeelectronics.ru