

HLMA-Kx00

T-1 (3 mm), High Performance
AlInGaP LED Lamps



Data Sheet

SunPower Series

HLMA-KL00 Series, HLMA-KH00 Series



Description

These untinted, non-diffused, solid state lamps utilize the latest absorbing/transparent substrate aluminum indium gallium phosphide (AlInGaP) LED technology. These materials have a very high luminous efficiency, capable of producing high light output over a wide range of drive currents. In addition, these LED lamps are at wavelengths ranging from amber to reddish orange.

Features

- Outstanding LED material efficiency
- High light output over a wide range of currents
- Low electrical power dissipation
- Colors: 590/592 nm Amber, 615/617 nm Reddish-Orange

Applications

- Outdoor message boards
- Safety lighting equipment
- Signaling applications
- Emitter for emitter/detector applications
- Changeable message signs
- Portable equipment
- Medical equipment
- Automotive lighting
- Alternative to incandescent lamps

Package Dimensions

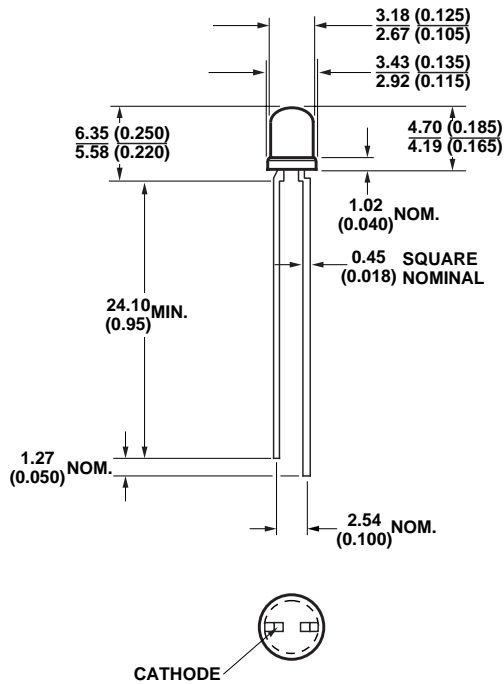

NOTES:

1. ALL DIMENSIONS ARE IN MILLIMETERS (INCHES).
2. THE LEADS ARE MILD STEEL, SOLDER DIPPED.
3. AN EPOXY MENISCUS MAY EXTEND ABOUT 1 MM (0.040") DOWN THE LEADS, UNLESS OTHERWISE NOTED.

Absolute Maximum Ratings at $T_A = 25^\circ\text{C}$

DC Forward Current ^[1,4,5]	50 mA
Peak Forward Current ^[2]	200 mA
Time Average Input Power ^[2]	103 mW
Transient Forward Current ^[3] (10 μs Pulse)	500 mA
Reverse Voltage ($I_R = 100 \mu\text{A}$)	5 V
Operating Temperature Range	-40 to 100°C
Storage Temperature	-40 to 100°C
Junction Temperature	110°C
Wave Soldering Temperature [1.59 mm (0.063 in.) from Body]	250°C for 3 seconds
Solder Dipping Temperature [1.59 mm (0.063 in.) from Body]	260°C for 5 seconds

Notes:

1. Derate linearly as shown in Figure 4.
2. Any pulsed operation cannot exceed the Absolute Max Peak Forward Current or the Max Allowable Time Average Power as specified in Figure 5.
3. The transient peak current is the maximum nonrecurring peak current the device can withstand without damaging the LED die and wire bonds.
4. Drive Currents between 10 mA and 30 mA are recommended for best long term performance.
5. Operation at currents below 10 mA is not recommended, please contact your Avago sales representative.

Optical Characteristics at $T_A = 25^\circ\text{C}$

Part Number	Luminous Intensity I_v (mcd) @ 20 mA ^[1]		Peak Wavelength λ_{peak} (nm)	Color, Dominant Wavelength λ_d ^[2] (nm)	Viewing Angle $2\theta_{1/2}$ Degrees ^[3]	Luminous Efficacy η_v (lm/w)
	Min.	Typ.	Typ.	Typ.	Typ.	
KL00	35	200	592	590	45	480
KH00	35	200	621	615	45	263

Notes:

1. The luminous intensity, I_v , is measured at the mechanical axis of the lamp package. The actual peak of the spatial radiation pattern may not be aligned with this axis.
2. The dominant wavelength, λ_d , is derived from the CIE Chromaticity Diagram and represents the color of the device.
3. $\theta_{1/2}$ is the off-axis angle where the luminous intensity is 1/2 the peak intensity.

Electrical Characteristics at $T_A = 25^\circ\text{C}$

Part Number	Forward Voltage V_F (Volts) @ $I_F = 20$ mA		Reverse Breakdown V_R (Volts) @ $I_R = 100$ μA		Capacitance C (pF) $V_F = 0$, $f = 1$ MHz	Thermal Resistance $R_{\theta J-PIN}$ ($^\circ\text{C}/\text{W}$)	Speed of Response τ_s (ns)
	Typ.	Max.	Min.	Typ.	Typ.		Time Constant e^{-t/τ_s}
KL00	1.9	2.4	5	25	40	290	13
KH00	1.9	2.4	5	25	40	290	13

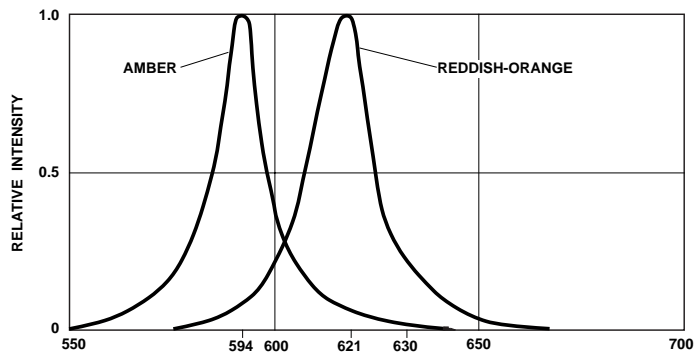

Figure 1. Relative intensity vs. wavelength.

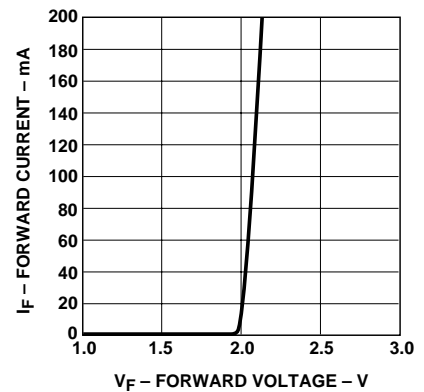

Figure 2. Forward current vs. forward voltage, AS-AlInGaP.

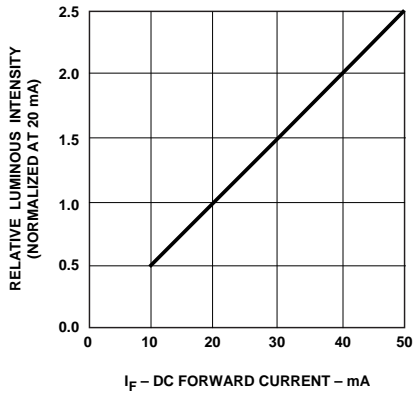

Figure 3. Relative luminous intensity vs. forward current. Derating based on T_{JMAX} .

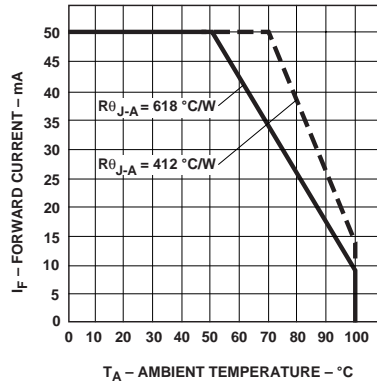

Figure 4. Maximum forward current vs. ambient temperature. Derating based on $T_{JMax} = 110$ °C.

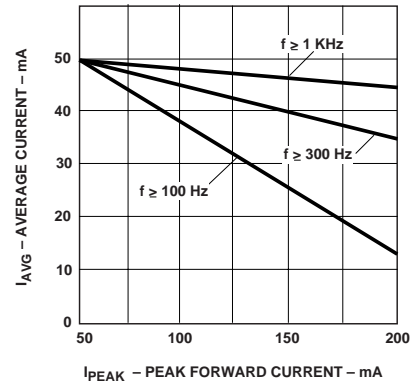

Figure 5. Maximum average current vs. peak forward current.

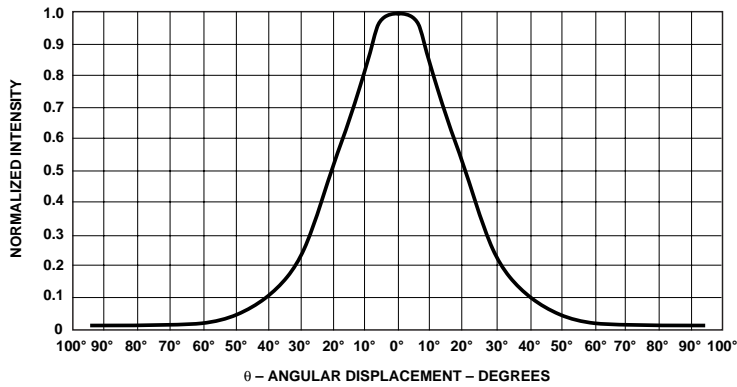

Figure 6. Normalized luminous intensity vs. angular displacement.

For product information and a complete list of distributors, please go to our website: www.avagotech.com

Avago, Avago Technologies, and the A logo are trademarks of Avago Technologies Limited in the United States and other countries. Data subject to change. Copyright © 2006 Avago Technologies Limited. All rights reserved. Obsoletes 5968-1439E 5989-3271EN June 30, 2006

AVAGO
TECHNOLOGIES

Компания «Life Electronics» занимается поставками электронных компонентов импортного и отечественного производства от производителей и со складов крупных дистрибьюторов Европы, Америки и Азии.

С конца 2013 года компания активно расширяет линейку поставок компонентов по направлению коаксиальный кабель, кварцевые генераторы и конденсаторы (керамические, пленочные, электролитические), за счёт заключения дистрибьюторских договоров

Мы предлагаем:

- Конкурентоспособные цены и скидки постоянным клиентам.
- Специальные условия для постоянных клиентов.
- Подбор аналогов.
- Поставку компонентов в любых объемах, удовлетворяющих вашим потребностям.
- Приемлемые сроки поставки, возможна ускоренная поставка.
- Доставку товара в любую точку России и стран СНГ.
- Комплексную поставку.
- Работу по проектам и поставку образцов.
- Формирование склада под заказчика.
- Сертификаты соответствия на поставляемую продукцию (по желанию клиента).
- Тестирование поставляемой продукции.
- Поставку компонентов, требующих военную и космическую приемку.
- Входной контроль качества.
- Наличие сертификата ISO.

В составе нашей компании организован Конструкторский отдел, призванный помогать разработчикам, и инженерам.

Конструкторский отдел помогает осуществить:

- Регистрацию проекта у производителя компонентов.
- Техническую поддержку проекта.
- Защиту от снятия компонента с производства.
- Оценку стоимости проекта по компонентам.
- Изготовление тестовой платы монтаж и пусконаладочные работы.



Тел: +7 (812) 336 43 04 (многоканальный)

Email: org@lifeelectronics.ru