

**HIGH EFFICIENCY 36V 1A BUCK LED DRIVER**

**Description**

The AL8805 is a step-down DC/DC converter designed to drive LEDs with a constant current. The device can drive up to 8 LEDs, depending on the forward voltage of the LEDs, in series from a voltage source of 6V to 36V. Series connection of the LEDs provides identical LED currents resulting in uniform brightness and eliminating the need for ballast resistors. The AL8805 switches at frequency up to 1MHz. This allows the use of small size external components, hence minimizing the PCB area needed.

Maximum output current of AL8805 is set via an external resistor connected between the  $V_{IN}$  and SET input pins. Dimming is achieved by applying either a DC voltage or a PWM signal at the CTRL input pin. An input voltage of 0.4V or lower at CTRL switches off the output MOSFET simplifying PWM dimming.

**Features**

- LED Driving Current up to 1A
- Better than 5% Accuracy
- High Efficiency up to 98%
- Operating Input Voltage from 6V to 36V
- High Switching Frequency up to 1MHz
- PWM/DC Input for Dimming Control
- Built-In Output Open-Circuit Protection
- SOT25: Available in "Green" Molding Compound (No Br,Sb) with lead Free Finish/ RoHS Compliant
  - **Totally Lead-Free & Fully RoHS Compliant (Notes 1 & 2)**
  - **Halogen and Antimony Free. "Green" Device (Note 3)**

- Notes:
1. No purposely added lead. Fully EU Directive 2002/95/EC (RoHS) & 2011/65/EU (RoHS 2) compliant.
  2. See <http://www.diodes.com> for more information about Diodes Incorporated's definitions of Halogen- and Antimony-free, "Green" and Lead-free.
  3. Halogen- and Antimony-free "Green" products are defined as those which contain <900ppm bromine, <900ppm chlorine (<1500ppm total Br + Cl) and <1000ppm antimony compounds.

**Pin Assignments**

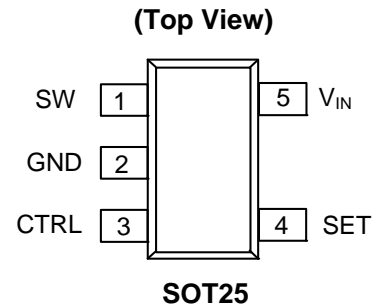

**Applications**

- MR16 Lamps
- General Illumination Lamps

**Typical Applications Circuit**

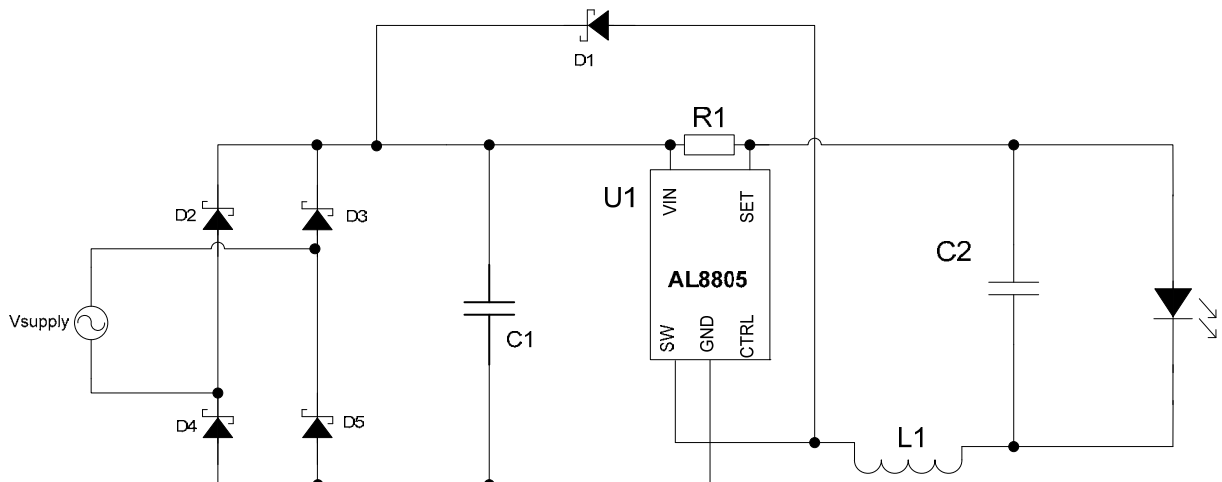

## Pin Descriptions

| Pin Number | Pin Name | Function   |
|------------|----------|--|
| 1          | SW       | Switch Pin. Connect inductor/freewheeling diode here, minimizing track length at this pin to reduce EMI.   |
| 2          | GND      | GND Pin  |
| 3          | CTRL     | Dimming and On/Off Control Input. <ul style="list-style-type: none"> <li>Leave floating for normal operation.<br/>(<math>V_{CTRL} = V_{REF} = 2.5V</math> giving nominal average output current <math>I_{OUTnom} = 0.1/R_S</math>)</li> <li>Drive to voltage below 0.4V to turn off output current</li> <li>Drive with DC voltage (<math>0.5V &lt; V_{CTRL} &lt; 2.5V</math>) to adjust output current from 20% to 100% of <math>I_{OUTnom}</math></li> <li>A PWM signal (low level <math>\leq 0.4V</math> and high level <math>&gt; 2.6</math>; transition times less than 1us) allows the output current to be adjusted below the level set by the resistor connected to SET input pin.</li> </ul> |
| 4          | SET      | Set Nominal Output Current Pin. Configure the output current of the device.  |
| 5          | $V_{IN}$ | Input Supply Pin. Must be locally decoupled to GND with $\geq 2.2\mu F$ X7R ceramic capacitor – see applications section for more information.   |

## Absolute Maximum Ratings (@ $T_A = +25^\circ C$ , unless otherwise specified.)

| Symbol      | Parameter                                       | Ratings     | Unit       |
|-------------|---|-------------|------------|
| ESD HBM     | Human Body Model ESD Protection                 | 2.5         | kV         |
| ESD MM      | Machine Model ESD Protection                    | 200         | V          |
| $V_{IN}$    | Continuous $V_{IN}$ Pin Voltage Relative to GND | -0.3 to 40  | V          |
| $V_{SET}$   | SET Pin Voltage Relative to $V_{IN}$ Pin        | -5 to +0.3  | V          |
| $V_{SW}$    | SW Voltage Relative to GND                      | -0.3 to 40  | V          |
| $V_{CTRL}$  | CTRL Pin Input Voltage                          | -0.3 to 6   | V          |
| $I_{SW-DC}$ | DC or RMS Switch current                        | 1.25        | A          |
| $I_{SW-PK}$ | Peak Switch Current (<10%)                      | 2.5         | A          |
| $T_J$       | Junction Temperature                            | 150         | $^\circ C$ |
| $T_{LEAD}$  | Lead Temperature Soldering                      | 300         | $^\circ C$ |
| $T_{ST}$    | Storage Temperature Range                       | -65 to +150 | $^\circ C$ |

Caution: Stresses greater than the 'Absolute Maximum Ratings' specified above, may cause permanent damage to the device. These are stress ratings only; functional operation of the device at these or any other conditions exceeding those indicated in this specification is not implied. Device reliability may be affected by exposure to absolute maximum rating conditions for extended periods of time.

Semiconductor devices are ESD sensitive and may be damaged by exposure to ESD events. Suitable ESD precautions should be taken when handling and transporting these devices

## Recommended Operating Conditions (@ $T_A = +25^\circ C$ , unless otherwise specified.)

| Symbol       | Parameter  | Min | Max | Unit       |
|--------------|--|-----|-----|------------|
| $V_{IN}$     | Operating Input Voltage relative to GND                  | 6.0 | 36  | V          |
| $V_{CTRLH}$  | Voltage High for PWM Dimming Relative to GND             | 2.6 | 5.5 | V          |
| $V_{CTRLDC}$ | Voltage Range for 20% to 100% DC Dimming Relative to GND | 0.5 | 2.5 | V          |
| $V_{CTRLLL}$ | Voltage Low for PWM Dimming Relative to GND              | 0   | 0.4 | V          |
| $I_{SW}$     | Continuous Switch Current                                | —   | 1   | A          |
| $T_J$        | Junction Temperature Range                               | -40 | 125 | $^\circ C$ |

---

**Electrical Characteristics** ( $V_{IN} = 12$ , @ $T_A = +25^\circ\text{C}$ , unless otherwise specified.)
 

---

| Symbol            | Parameter                                       | Conditions                            | Min | Typ      | Max | Unit                      |
|-------------------|---|---------------------------------------|-----|----------|-----|---------------------------|
| $V_{INSU}$        | Internal Regulator Start Up Threshold           | $V_{IN}$ rising                       |     |          | 5.9 | V                         |
| $V_{INSH}$        | Internal Regulator Hysteresis Threshold         | $V_{IN}$ falling                      | 100 |          | 300 | mV                        |
| $I_Q$             | Quiescent Current                               | Output not switching (Note 4)         |     |          | 350 | $\mu\text{A}$             |
| $I_S$             | Input Supply Current                            | CTRL pin floating $f = 250\text{kHz}$ |     | 1.8      | 5   | mA                        |
| $V_{TH}$          | Set Current Threshold Voltage                   |                                       | 95  | 100      | 105 | mV                        |
| $V_{TH-H}$        | Set Threshold Hysteresis                        |                                       |     | $\pm 20$ |     | mV                        |
| $I_{SET}$         | SET Pin Input Current                           | $V_{SET} = V_{IN} - 0.1$              |     | 16       | 22  | $\mu\text{A}$             |
| $R_{CTRL}$        | CTRL Pin Input Resistance                       | Referred to internal reference        |     | 50       |     | k $\Omega$                |
| $V_{REF}$         | Internal Reference Voltage                      |                                       |     | 2.5      |     | V                         |
| $R_{DS(on)}$      | On Resistance of SW MOSFET                      | $I_{SW} = 1\text{A}$                  |     | 0.25     | 0.4 | $\Omega$                  |
| $I_{SW\_Leakage}$ | Switch Leakage Current                          | $V_{IN} = 30\text{V}$                 |     |          | 0.5 | $\mu\text{A}$             |
| $f_{OSC}$         | Switching Frequency                             |                                       |     |          | 1   | MHz                       |
| $\theta_{JA}$     | Thermal Resistance Junction-to-Ambient (Note 5) | SOT25 (Note 6)                        |     | 250      |     | $^\circ\text{C}/\text{W}$ |
| $\Psi_{JB}$       | Thermal Resistance Junction-to-Lead (Note 7)    | SOT25                                 |     | 50       |     |                           |

- Notes:
4. AL8805 does not have a low power standby mode but current consumption is reduced when output switch is inhibited:  $V_{SENSE} = 0\text{V}$ . Parameter is tested with  $V_{CTRL} \leq 2.5\text{V}$
  5. Refer to figure 34 for the device derating curve.
  6. Test condition for SOT25: Device mounted on FR-4 PCB (25mm x 25mm 1oz copper, minimum recommended pad layout on top layer and thermal vias to bottom layer ground plane. For better thermal performance, larger copper pad for heat-sink is needed.
  7. As SOT25 doesn't have an exposed tab or exposed pad the majority of heat flow is through pin 2 down to ground.

**Typical Performance Characteristics** (@ $T_A = +25^\circ\text{C}$ , unless otherwise specified.)

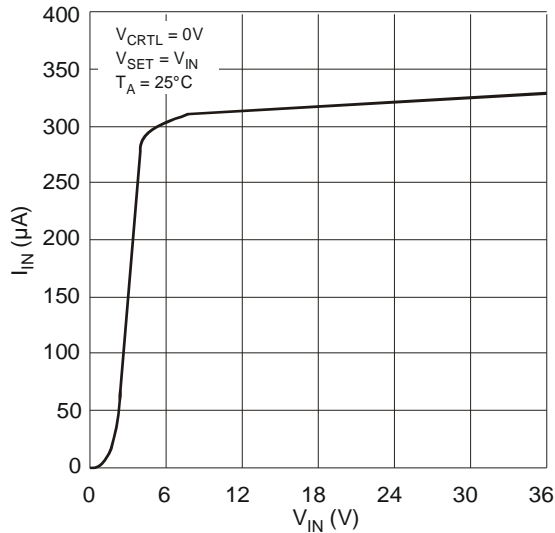

Figure 1 Supply Current (not switching) vs. Input Voltage

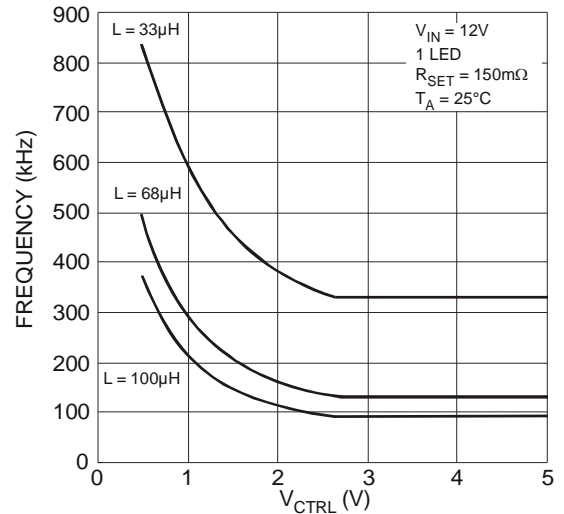

Figure 2 Switching Frequency vs.  $V_{CTRL}$

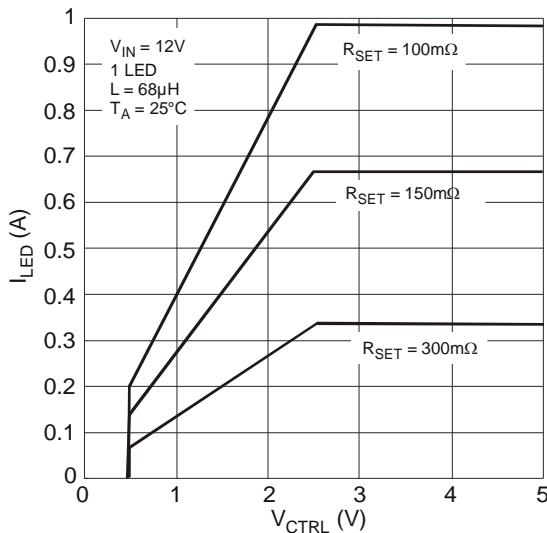

Figure 3 LED Current vs.  $V_{CTRL}$

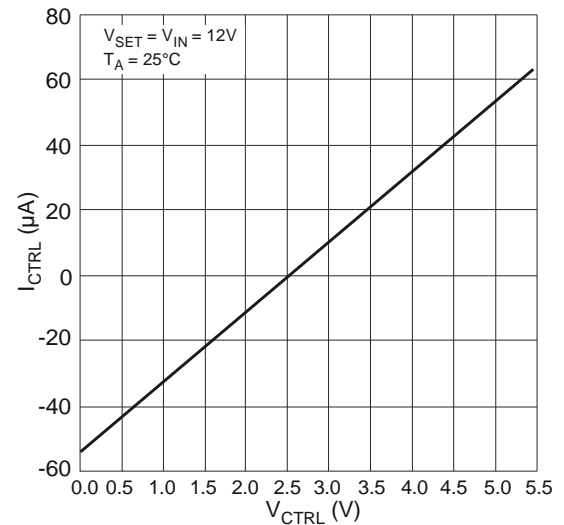

Figure 4  $I_{CTRL}$  vs.  $V_{CTRL}$

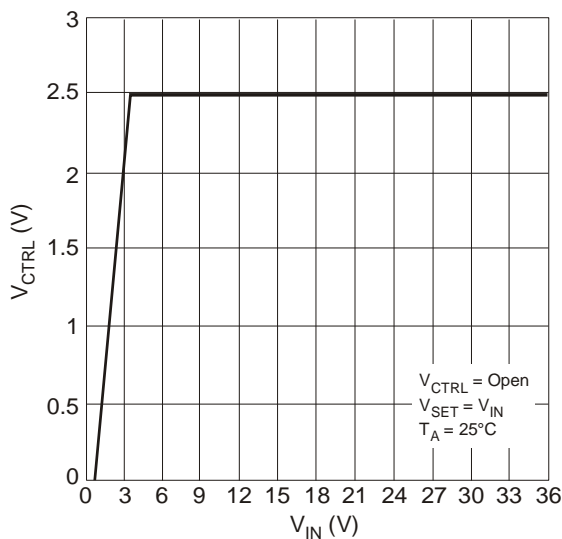

Figure 5  $V_{CTRL}$  vs. Input Voltage (CTRL Pin Open Circuit)

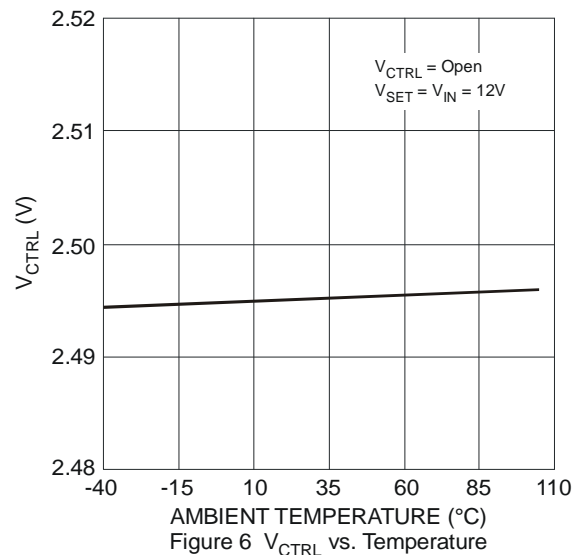

Figure 6  $V_{CTRL}$  vs. Temperature

**Typical Performance Characteristics** (cont.) (@ $T_A = +25^\circ\text{C}$ , unless otherwise specified.)

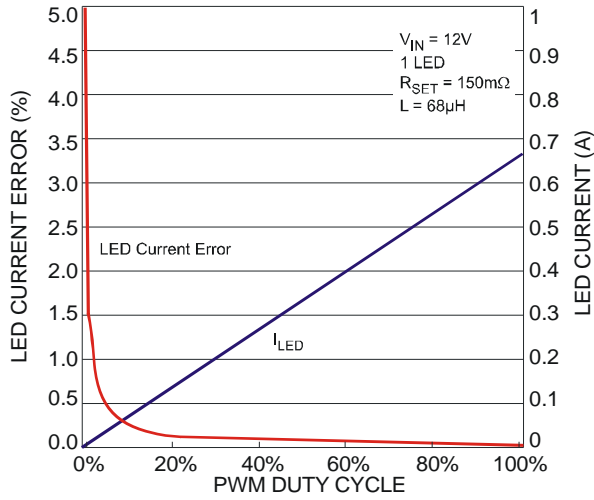

Figure 7  $I_{LED}$  vs. PWM Duty Cycle

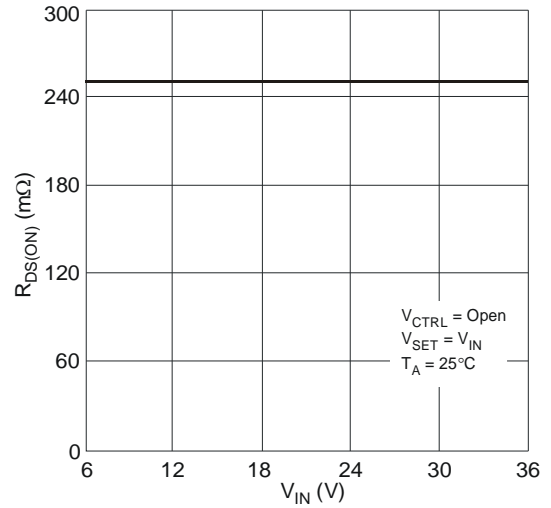

Figure 8 SW  $R_{DS(ON)}$  vs. Input Voltage

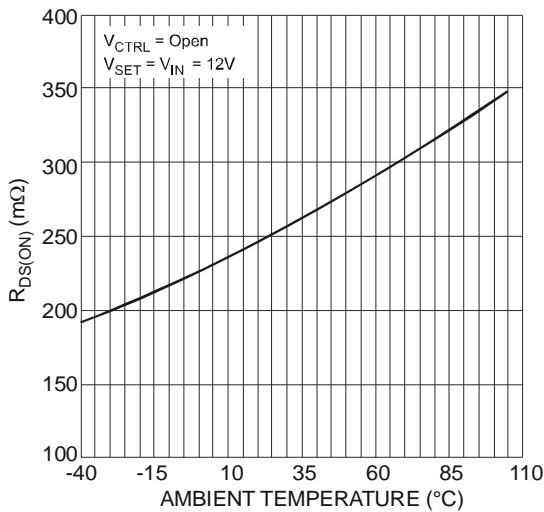

Figure 9 SW  $R_{DS(ON)}$  vs. Temperature

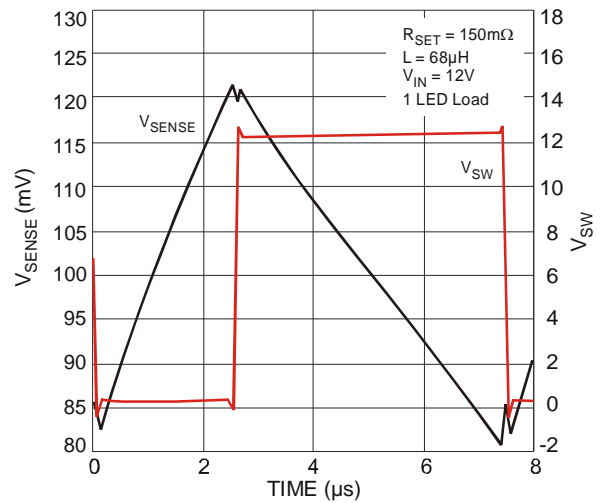

Figure 10 SW Output Switching Characteristics

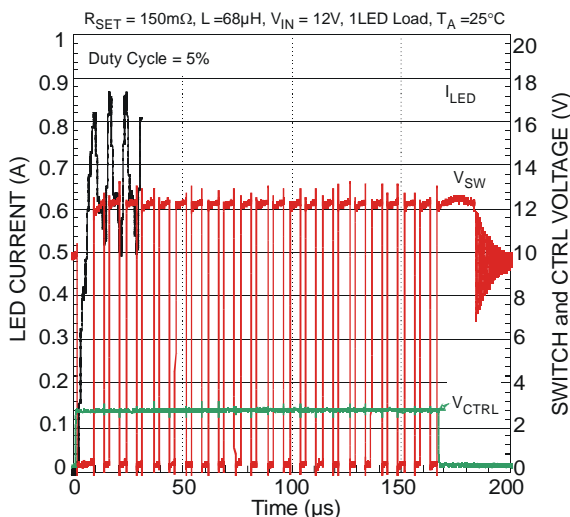

Figure 11 PWM Dimming

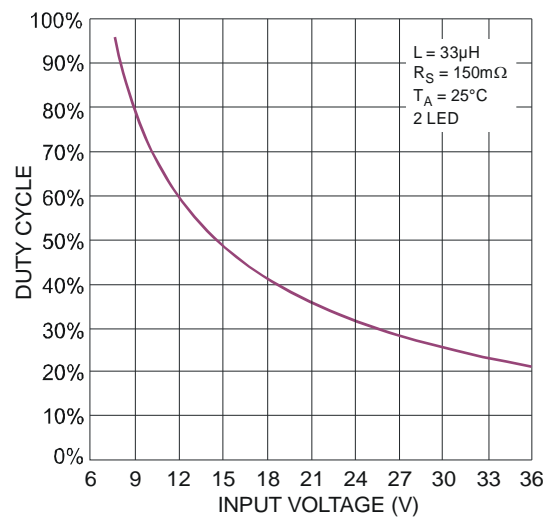

Figure 12 Duty Cycle vs. Input Voltage

**Typical Performance Characteristics** (cont.) (@ $T_A = +25^\circ\text{C}$ , unless otherwise specified.)

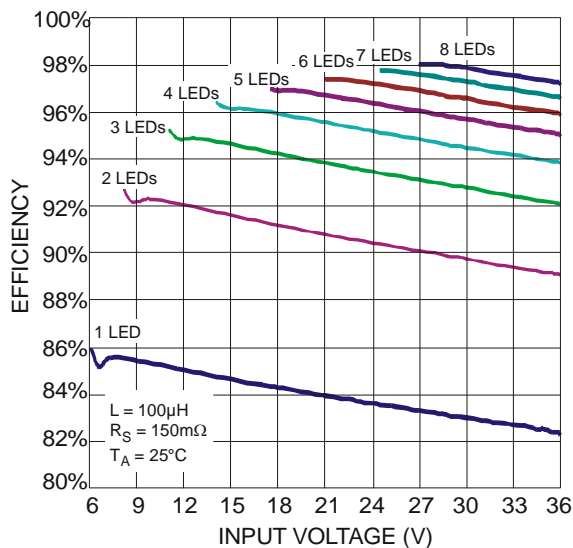

Figure 13 Efficiency vs. Input Voltage

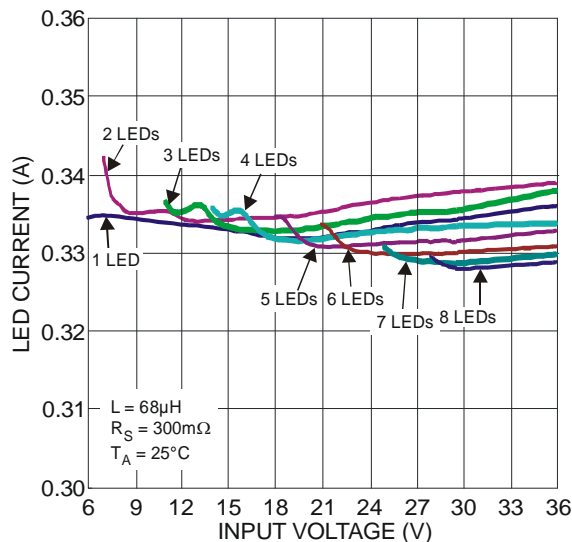

Figure 14 330mA LED Current vs. Input Voltage

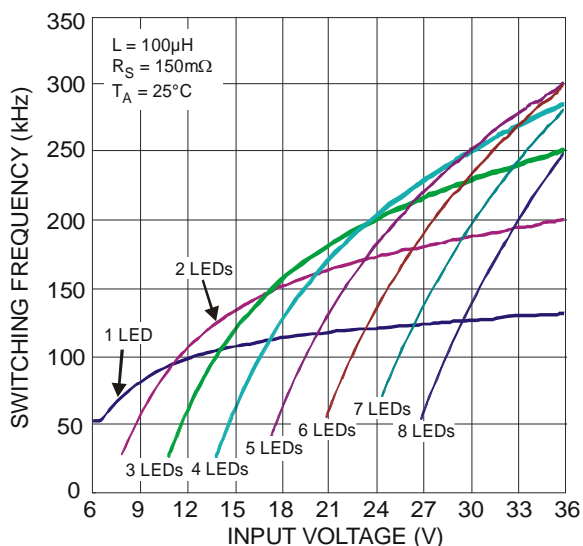

Figure 15 Switching Frequency vs. Input Voltage

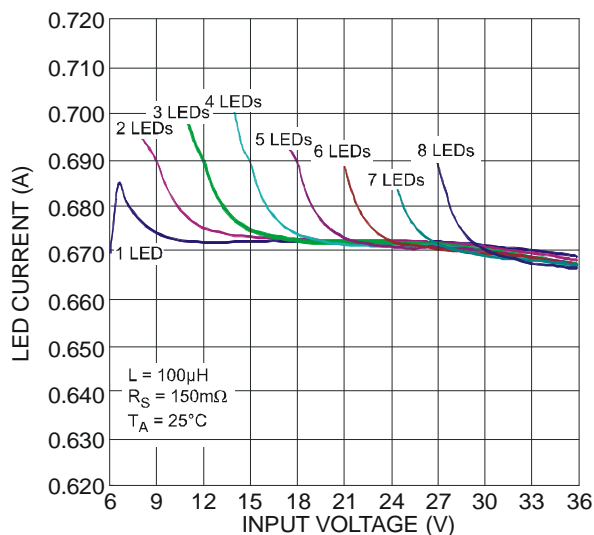

Figure 16 670mA LED Current vs. Input Voltage

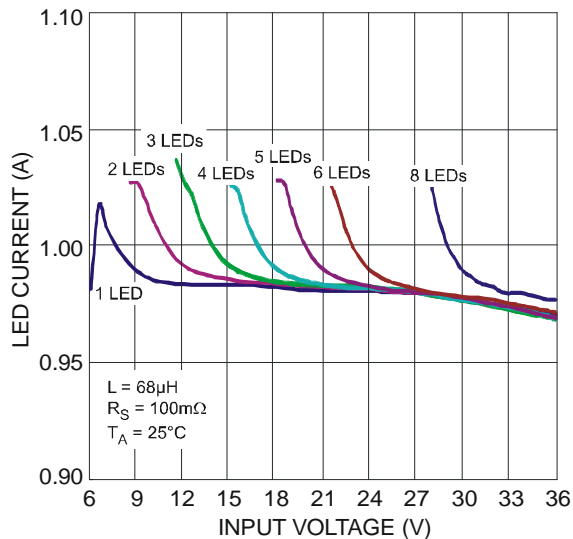

Figure 17 1A LED Current vs. Input Voltage

**Typical Performance Characteristics** (cont.) (670mA LED Current) (@ $T_A = +25^\circ\text{C}$ , unless otherwise specified.)

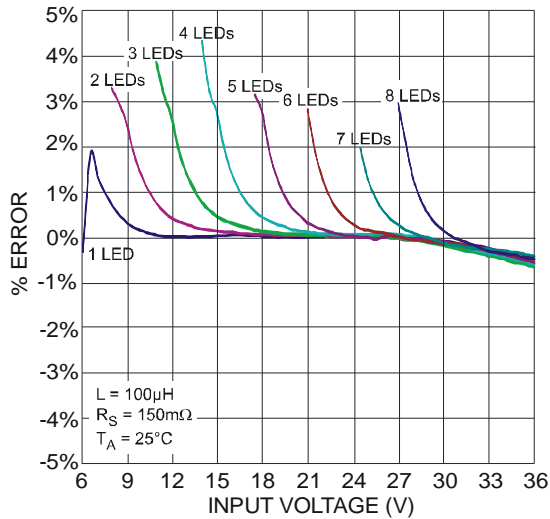

Figure 18 LED Current Deviation vs. Input Voltage

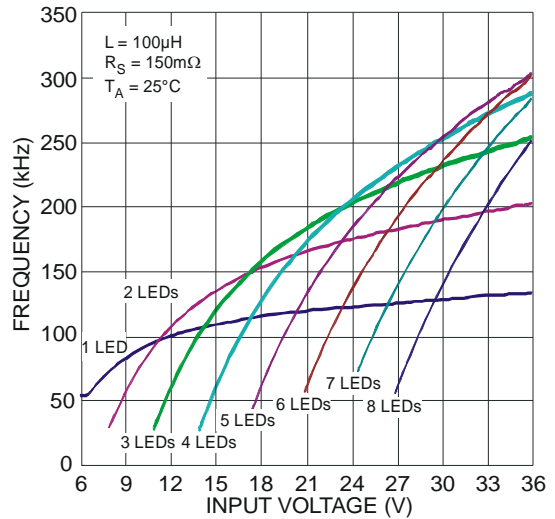

Figure 19 Switching Frequency vs. Input Voltage

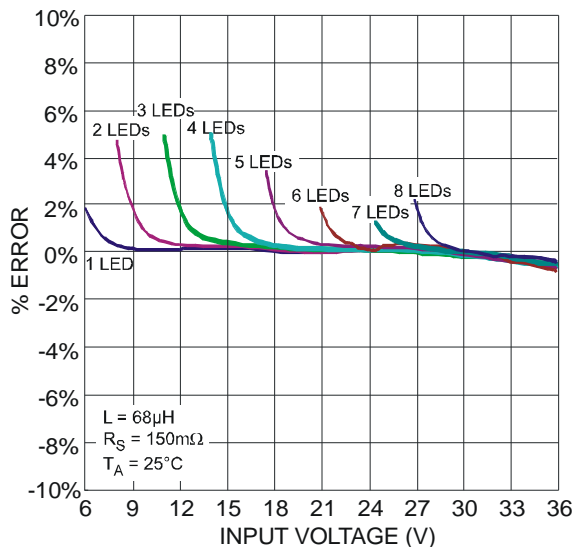

Figure 20 LED Current Deviation vs. Input Voltage

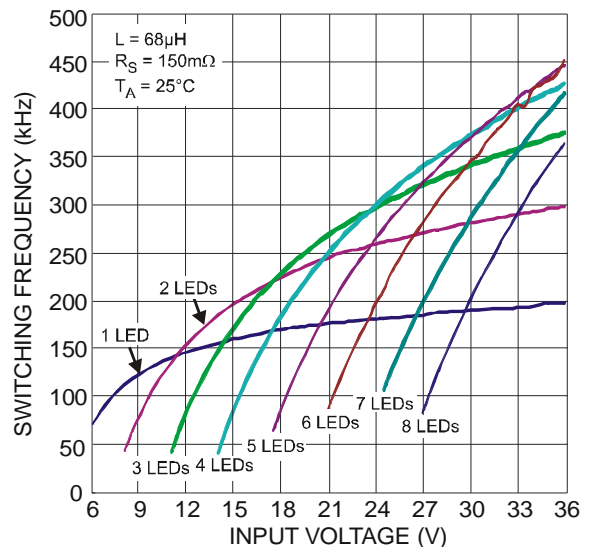

Figure 21 Switching Frequency vs. Input Voltage

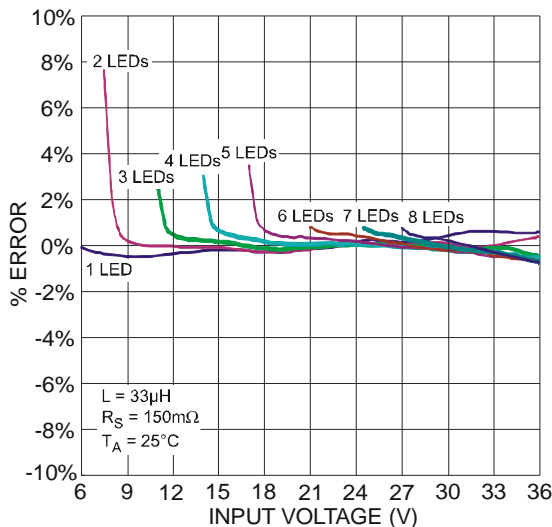

Figure 22 LED Current Deviation vs. Input Voltage

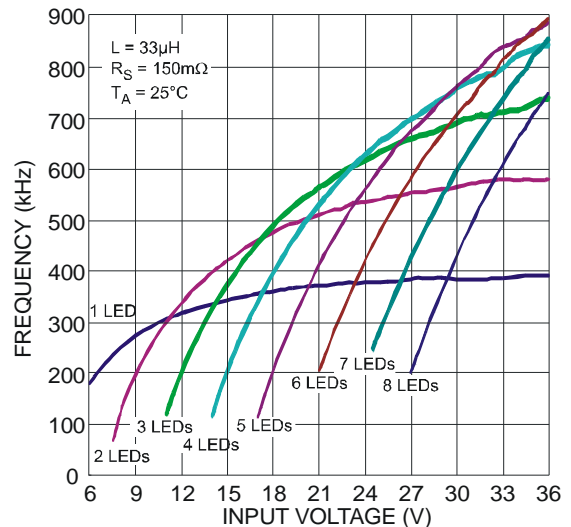

Figure 23 Switching Frequency vs. Input Voltage

**Typical Performance Characteristics** (cont.) (1A LED Current) (@ $T_A = +25^\circ\text{C}$ , unless otherwise specified.)

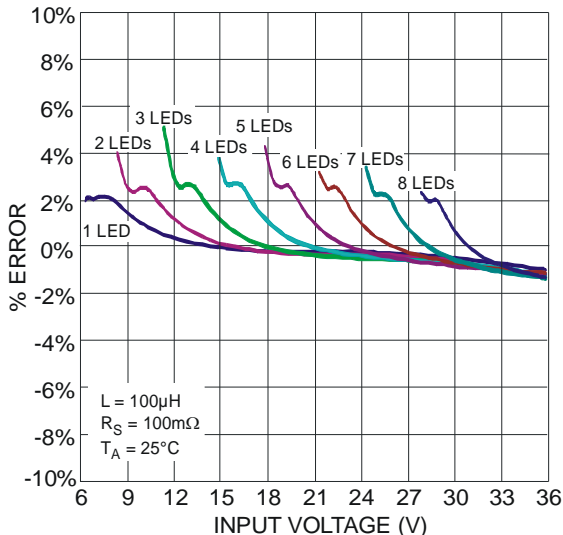

Figure 24 LED Current Deviation vs. Input Voltage

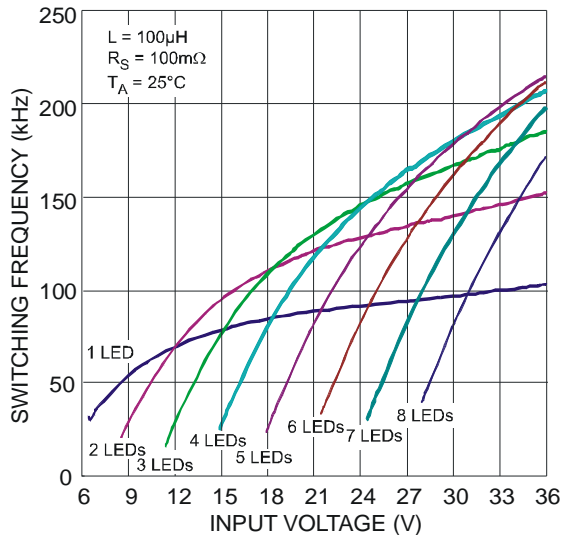

Figure 25 Switching Frequency vs. Input Voltage

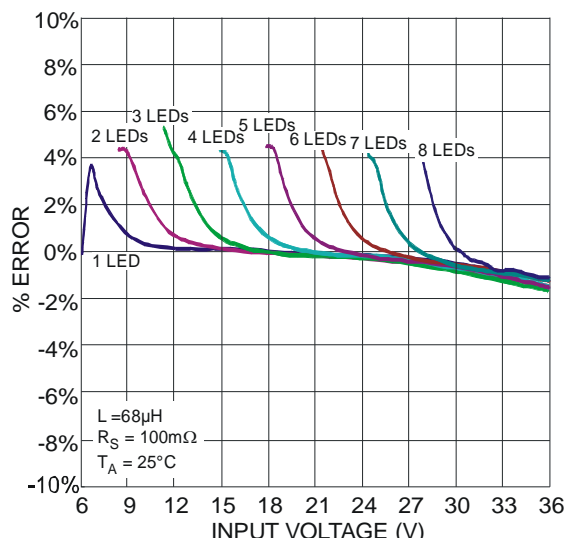

Figure 26 LED Current Deviation vs. Input Voltage

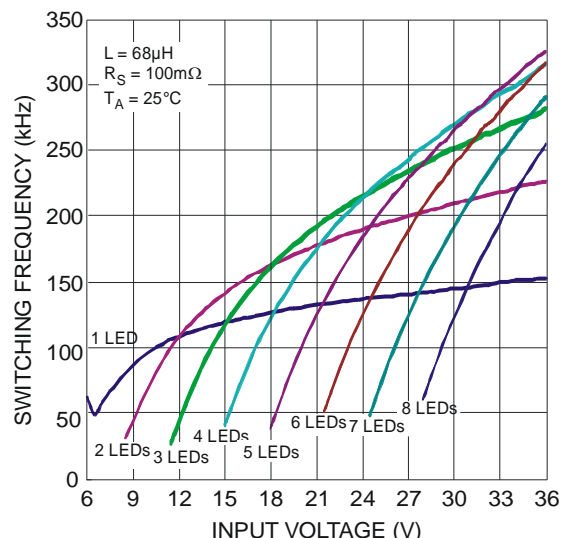

Figure 27 Switching Frequency vs. Input Voltage

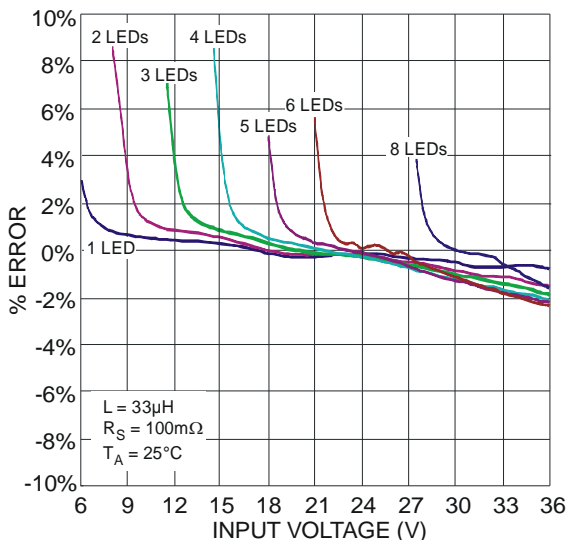

Figure 28 LED Current Deviation vs. Input Voltage

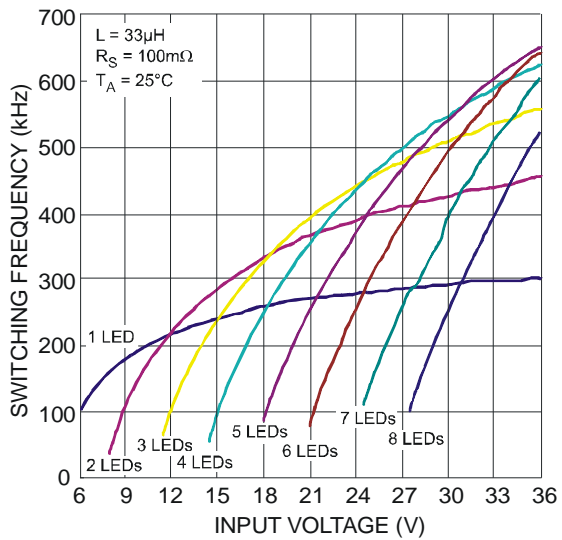

Figure 29 Switching Frequency vs. Input Voltage



## Application Information

### AL8805 Operation

In normal operation, when voltage is applied at +V<sub>IN</sub>, the AL8805 internal switch is turned on. Current starts to flow through sense resistor R<sub>1</sub>, inductor L<sub>1</sub>, and the LEDs. The current ramps up linearly, and the ramp rate is determined by the input voltage +V<sub>IN</sub> and the inductor L<sub>1</sub>.

This rising current produces a voltage ramp across R<sub>1</sub>. The internal circuit of the AL8805 senses the voltage across R<sub>1</sub> and applies a proportional voltage to the input of the internal comparator.

When this voltage reaches an internally set upper threshold, the internal switch is turned off. The inductor current continues to flow through R<sub>1</sub>, L<sub>1</sub>, the LEDs and the schottky diode D<sub>1</sub>, and back to the supply rail, but it decays, with the rate of decay determined by the forward voltage drop of the LEDs and the schottky diode.

This decaying current produces a falling voltage at R<sub>1</sub>, which is sensed by the AL8805. A voltage proportional to the sense voltage across R<sub>1</sub> is applied at the input of the internal comparator. When this voltage falls to the internally set lower threshold, the internal switch is turned on again. This switch-on-and-off cycle continues to provide the average LED current set by the sense resistor R<sub>1</sub>.

### LED Current Control

The LED current is controlled by the resistor R<sub>1</sub> in Figure 30.

Connected between V<sub>IN</sub> and SET the nominal average output current in the LED(s) is defined as:

$$I_{LED} = \frac{V_{THD}}{R_{SET}}$$

If the CTRL pin is driven by an external voltage (higher than 0.4V and lower than 2.5V), the average LED current is:

$$I_{LED} = \frac{V_{CTRL}}{V_{REF}} \frac{V_{THD}}{R_{SET}}$$

For example for a desired LED current of 660mA and a default voltage V<sub>CTRL</sub>=2.5V the resulting resistor is:

$$R_{SET} = \frac{V_{THD}}{I_{LED}} \frac{V_{CTRL}}{V_{REF}} = \frac{0.1}{0.66} \frac{2.5}{2.5} \approx 150m\Omega$$

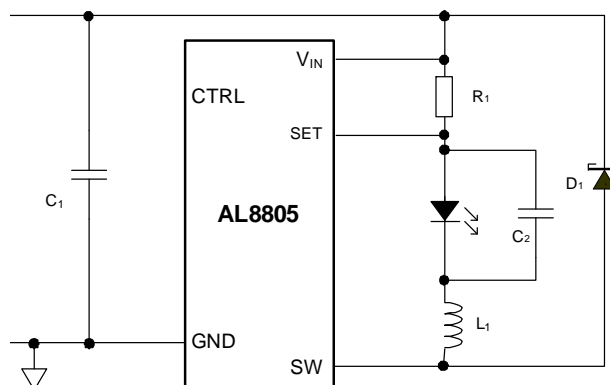

**Figure 30 Typical Application Circuit**

### DC Dimming

The CTRL pin can be driven by an external DC voltage (V<sub>CTRL</sub>), to adjust the output current to a value below the nominal average value defined by R<sub>SET</sub>. The LED current decreases linearly with the CTRL voltage when 0.5V ≤ V<sub>CTRL</sub> ≤ 2.5V, as in Figure 2 for 4 different current levels.

When the CTRL voltage falls below the threshold, 0.4V, the output switch is turned off which allows PWM dimming.

Note that 100% brightness setting corresponds to V<sub>CTRL</sub> = V<sub>REF</sub>, nominally 2.5V. For any voltage applied on the CTRL pin that is higher than V<sub>REF</sub>, the device will not overdrive the LED current and will still set the current according to the equation V<sub>CTRL</sub> = V<sub>REF</sub>.

**Application Information** (cont.)

**PWM Dimming**

LED current can be adjusted digitally, by applying a low frequency Pulse Width Modulated (PWM) logic signal to the CTRL pin to turn the device on and off. This will produce an average output current proportional to the duty cycle of the control signal. In particular, a PWM signal with a max resolution of 10bit can be applied to the CTRL pin to change the output current to a value below the nominal average value set by resistor  $R_{SET}$ . To achieve this resolution the PWM frequency has to be lower than 500Hz, however higher dimming frequencies can be used, at the expense of dimming dynamic range and accuracy.

Typically, for a PWM frequency of 500Hz the accuracy is better than 1% for PWM ranging from 1% to 100%.

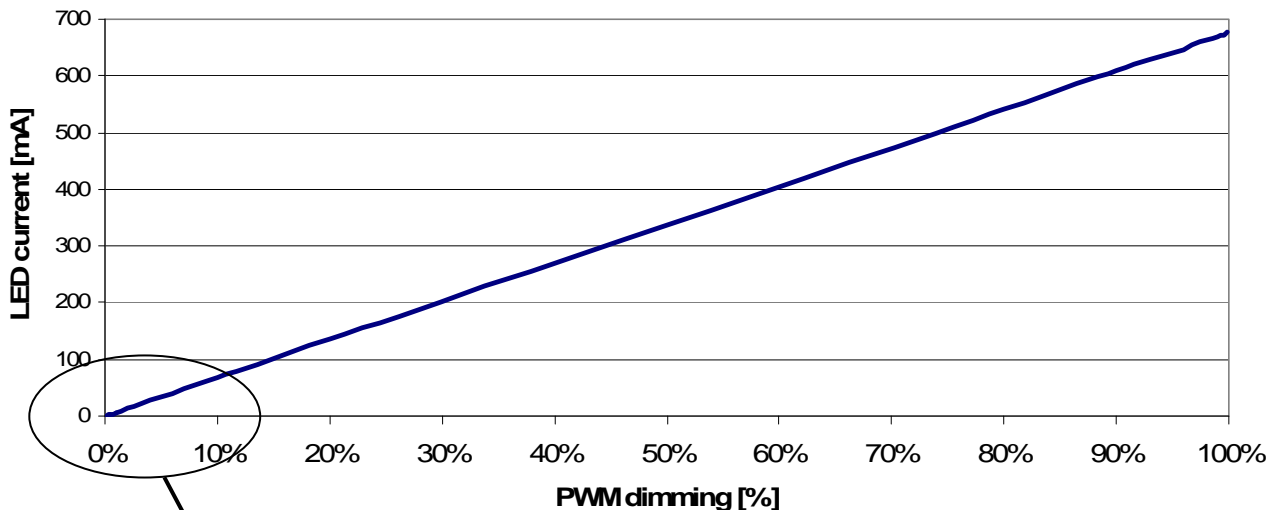

Figure 31 PWM Dimming at 500Hz

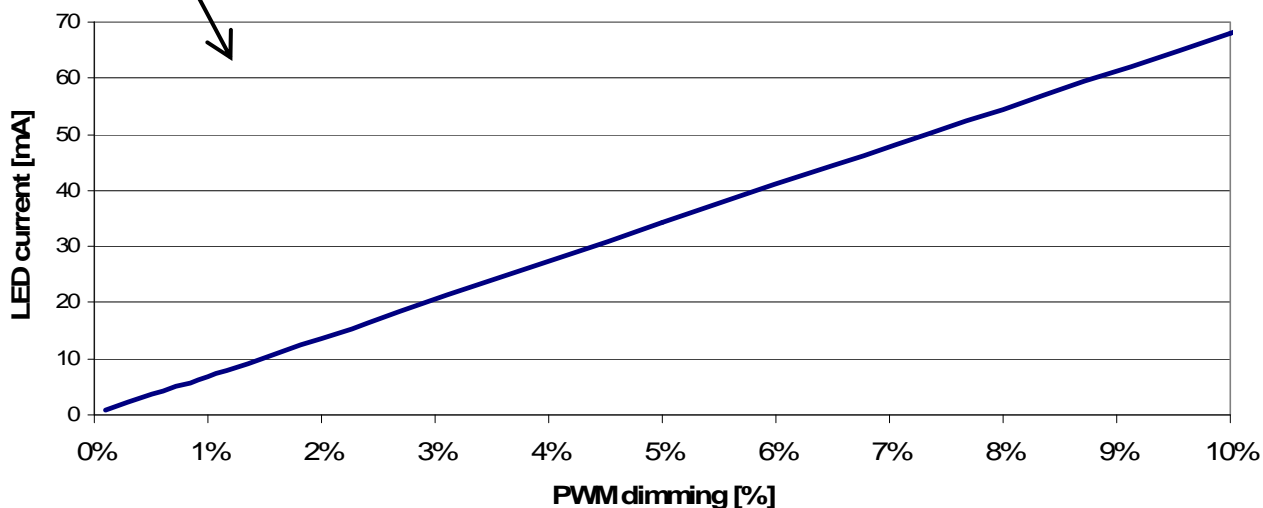
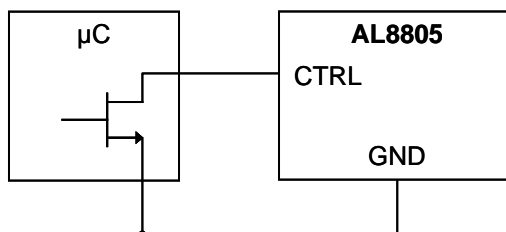

Figure 32 Low Duty Cycle PWM Dimming at 500Hz

The CTRL pin is designed to be driven by both 3.3V and 5V logic levels directly from a logic output with either an open drain output or push-pull output stage.



## Application Information (cont.)

### Soft Start

The AL8805 does not have in-built soft-start action – this provides very fast turn off of the output the stage improving PWM dimming accuracy; nonetheless, adding an external capacitor from the CTRL pin to ground will provide a soft-start delay. This is achieved by increasing the time taken for the CTRL voltage to rise to the turn-on threshold and by slowing down the rate of rise of the control voltage at the input of the comparator. Adding a capacitor increases the time taken for the output to reach 90% of its final value, this delay is 0.1ms/nF, but will impact on the PWM dimming accuracy depending on the delay introduced.

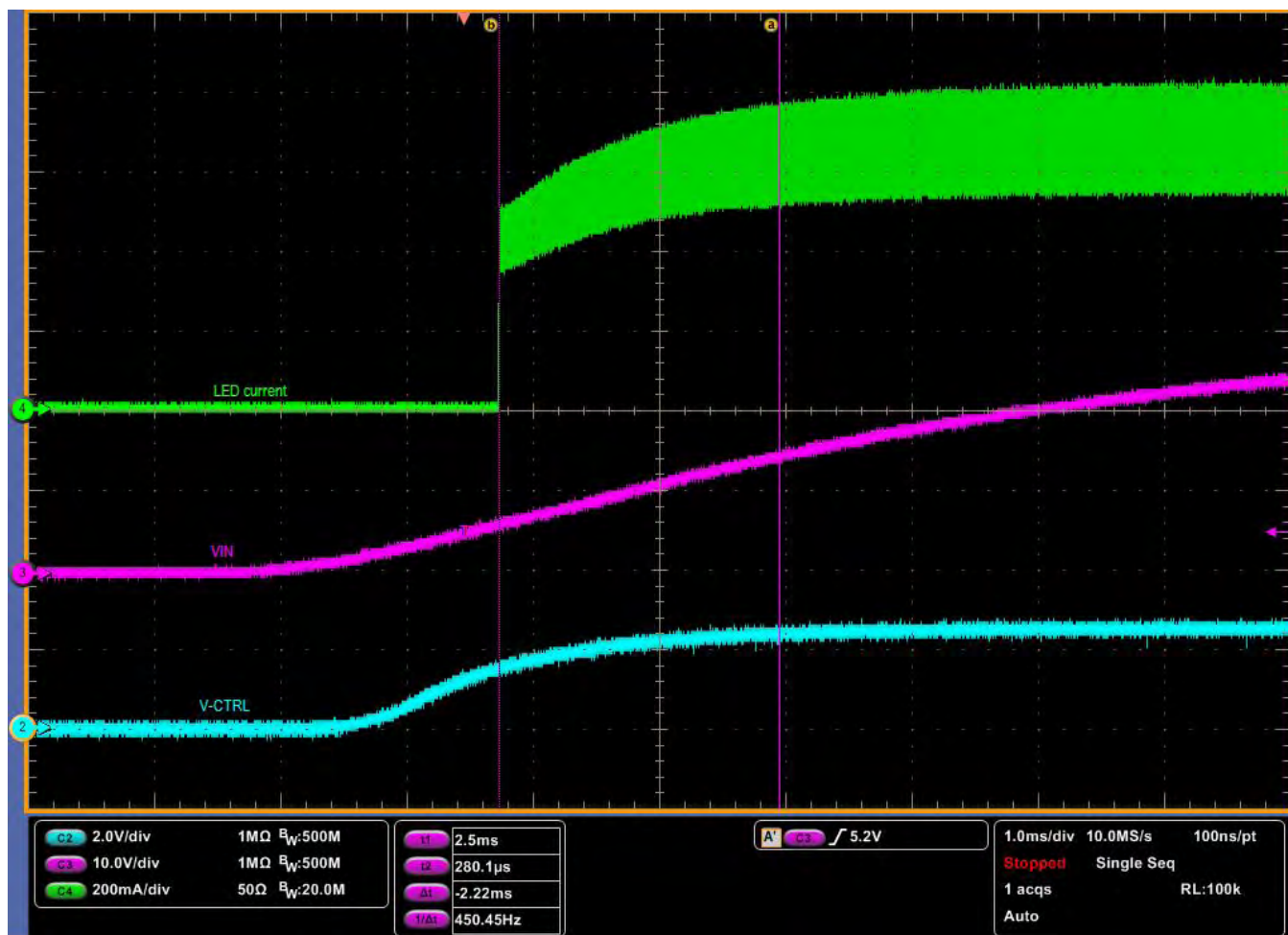

Figure 33 Soft Start with 22nF Capacitor on CTRL Pin ( $V_{IN} = 36V$ ,  $I_{LED} = 667mA$ , 1 LED)

### Reducing Output Ripple

Peak to peak ripple current in the LED(s) can be reduced, if required, by shunting a capacitor C2 across the LED(s) as shown already in the circuit schematic.

A value of 1 $\mu$ F will reduce the supply ripple current by a factor three (approx.). Proportionally lower ripple can be achieved with higher capacitor values. Note that the capacitor will not affect operating frequency or efficiency, but it will increase start-up delay, by reducing the rate of rise of LED voltage. By adding this capacitor the current waveform through the LED(s) changes from a triangular ramp to a more sinusoidal version without altering the mean current value.

### Capacitor Selection

The small size of ceramic capacitors makes them ideal for AL8805 applications. X5R and X7R types are recommended because they retain their capacitance over wider voltage and temperature ranges than other types such as Z5U.

A 2.2 $\mu$ F input capacitor is sufficient for most intended applications of AL8805; however a 4.7 $\mu$ F input capacitor is suggested for input voltages approaching 36V.

## Application Information (cont.)

### Diode Selection

For maximum efficiency and performance, the rectifier (D1) should be a fast low capacitance Schottky diode with low reverse leakage at the maximum operating voltage and temperature. The Schottky diode also provides better efficiency than silicon PN diodes, due to a combination of lower forward voltage and reduced recovery time.

It is important to select parts with a peak current rating above the peak coil current and a continuous current rating higher than the maximum output load current. In particular, it is recommended to have a diode voltage rating at least 15% higher than the operating voltage to ensure safe operation during the switching and a current rating at least 10% higher than the average diode current. The power rating is verified by calculating the power loss through the diode.

Schottky diodes, e.g. B240 or B140, with their low forward voltage drop and fast reverse recovery, are the ideal choice for AL8805 applications.

### Thermal and Layout Considerations

For continuous conduction mode of operation, the absolute maximum junction temperature must not be exceeded. The maximum power dissipation depends on several factors: the thermal resistance of the IC package  $\theta_{JA}$ , PCB layout, airflow surrounding the IC, and difference between junction and ambient temperature.

The maximum power dissipation can be calculated using the following formula:

$$P_{D(MAX)} = (T_{J(MAX)} - T_A) / \theta_{JA}$$

where

- $T_{J(MAX)}$  is the maximum operating junction temperature,
- $T_A$  is the ambient temperature, and
- $\theta_{JA}$  is the junction to ambient thermal resistance.

The recommended maximum operating junction temperature,  $T_J$ , is +125°C and so maximum ambient temperature is determined by the AL8805's junction to ambient thermal resistance,  $\theta_{JA}$ .

$\theta_{JA}$ , is layout dependent and the AL8805's  $\theta_{JA}$  on a 25 x 25mm single layer PCB with 1oz copper standing in still air is approximately +250°C/W (+160°C/W on a four-layer PCB).

The maximum power dissipation at  $T_A = +25^\circ\text{C}$  can be calculated by the following formulas:

$$P_{D(MAX)} = (+125^\circ\text{C} - +25^\circ\text{C}) / (250^\circ\text{C/W}) = 0.4\text{W for single-layer PCB}$$

$$P_{D(MAX)} = (+125^\circ\text{C} - +25^\circ\text{C}) / (160^\circ\text{C/W}) = 0.625\text{W for standard four-layer PCB}$$

Figure 34, shows the power derating of the AL8805 on two (one single-layer and four-layer) different 25x25mm PCB with 1oz copper standing in still air.

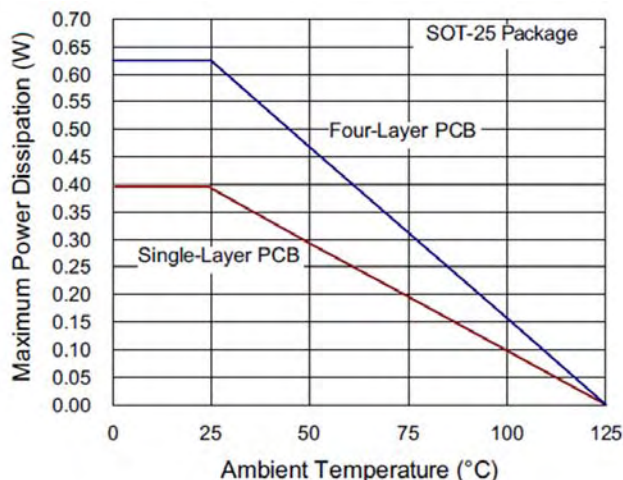

Figure 34 Derating Curve for Different PCB

**Application Information** (cont.)

**Thermal and Layout Considerations**

Figure 35 gives details about the PCB layout suggestions:

1. the capacitor C1 has to be placed as close as possible to  $V_{IN}$
2. The sense resistor R1 has to be placed as close as possible to  $V_{IN}$  and SET
3. The D1 anode, the SW pin and the inductor have to be placed as close as possible to avoid ringing.

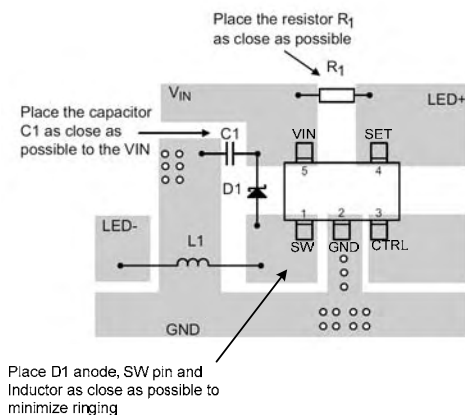

**Figure 35 Recommended PCB Layout**

**Application Example**

Typical application example for the AL8805 is the MR16 lamp. They typically operate from 12V<sub>DC</sub> or 12V<sub>AC</sub>, using conventional electromagnetic transformers or electronic transformers.

As a replacement in some halogen lamp applications LEDs offer a more energy efficient solution – providing no radiated heat and no Ultra Violet light.

This application example is intended to fit into the base connector space of an MR16 style LED lamp. The design has been optimized for part count and thermal performance for a single 3W LED in the Lens section.

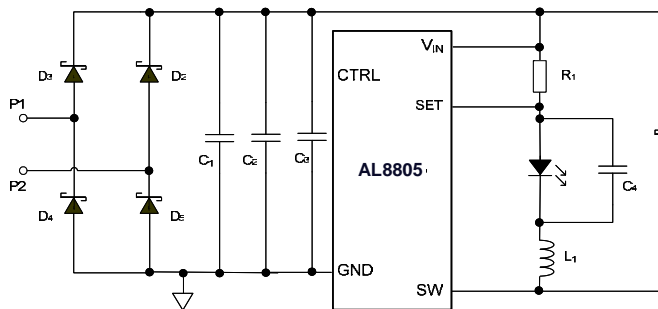

**Figure 36 MR16 Schematic**

An inductor choice of 33μH with saturation current higher than 1.1A, will limit the frequency variation between 230kHz and 350kHz over the whole input voltage variation (8V to 18V), and therefore represent the best choice for an MR16 solution also taking into account the size constraint of the lamp.

The AL8805 guarantee high level of performance both with 12V<sub>AC</sub> and 12V<sub>DC</sub> power supply.

The efficiency is generally higher than 81% and current regulation is better than 0.1mA/V in for a DC input voltage in the range from 8V to 18V. In table 1 can be found the bill of material of the MR16 application example.

**Application Information** (cont.)

In Figures 37 and 38 are displayed the top layer and the bottom layer of a typical PCB design for an MR16 solution.

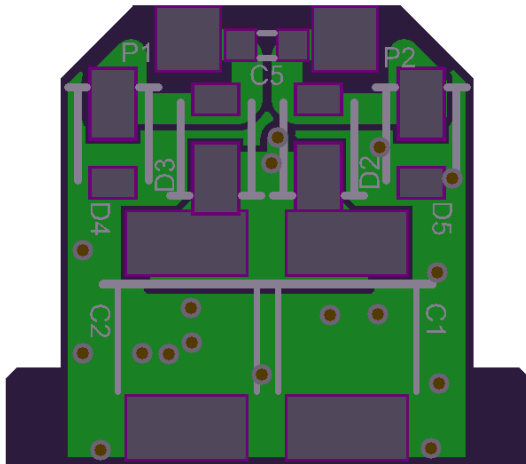

Figure 37 Top Layer

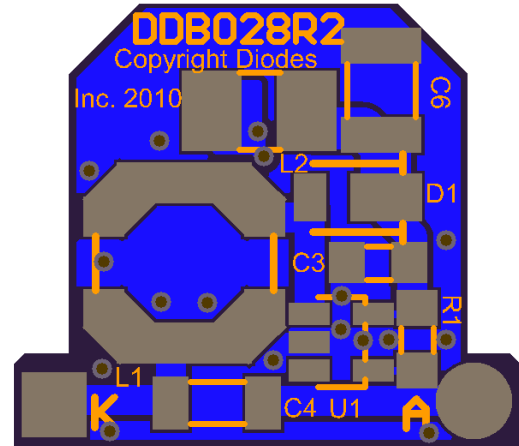
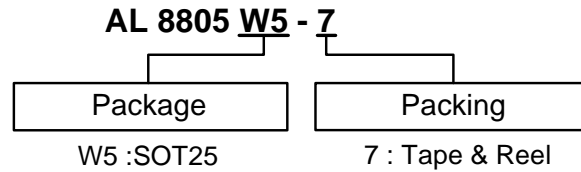

Figure 38 Bottom Layer

Table1 MR16 Application Example Bill of Material

| Quantity | PCB Ident      | Value         | Description   | Suggested Sources       |
|----------|----------------|---------------|---|-------------------------|
| 1        | U1             | AL8805        | LED Driver IC   | Diodes Zetex            |
| 1        | D1,            | DFLS240L      | freewheeling diode  | Diodes Zetex            |
| 4        | D2, D3, D4, D5 | SBR2A40       | Input bridge  | Diodes Zetex            |
| 1        | R1             | 0R15          | Resistor, 0805, +/-1% <+/-300ppm Generic<br>KOA SR732ATTDR150F                | Kemet                   |
| 1        | C1             | 150uF 20V     | SMD tantalum Kemet D case, T491X157K020AT                                     | Kemet                   |
| 0        | C2             | -             | Not fitted  |                         |
| 1        | C3             | 100nF > = 25V | X7R 0805 Generic Kemet C0805C104K5RAC (50v)<br>NIC NMC0805X7R104K50TRPF (50v) | Kemet<br>NIC Components |
| 1        | C4             | 1uF > = 25V   | X7R 1206 Generic Kemet C1206105K5RAC7800 (50v)<br>NIC NMC1206X7R105K50F (50v) | Kemet<br>NIC Components |
| 1        | L1             | 33uH          | LPS6235 - 333MLB  | Coilcraft               |

**Ordering Information**



| Device     | Package Code | Packaging (Note 6) | 7" Tape and Reel |                    |
|------------|--------------|--------------------|------------------|--------------------|
|            |              |                    | Quantity         | Part Number Suffix |
| AL8805W5-7 | W5           | SOT25              | 3000/Tape & Reel | -7                 |

Note: 8. Pad layout as shown on Diodes Inc. suggested pad layout document AP02001, which can be found on our website at: <http://www.diodes.com/datasheets/ap02001.pdf>.

**Marking Information**

(Top View)

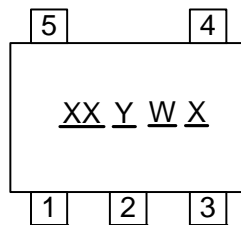

XX : Identification code  
Y : Year 0~9  
W : Week : A~Z : 1~26 week;  
a~z : 27~52 week; z represents 52 and 53 week  
X : A~Z : Internal code

| Part Number | Package | Identification Code |
|-------------|---------|---------------------|
| AL8805W5-7  | SOT25   | A6                  |

**Package Outline Dimensions** (All dimensions in mm.)

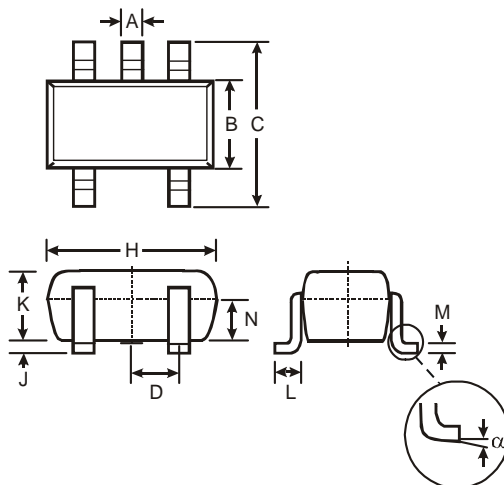

| SOT25                       |       |      |      |
|-----------------------------|-------|------|------|
| Dim                         | Min   | Max  | Typ  |
| A                           | 0.35  | 0.50 | 0.38 |
| B                           | 1.50  | 1.70 | 1.60 |
| C                           | 2.70  | 3.00 | 2.80 |
| D                           | —     | —    | 0.95 |
| H                           | 2.90  | 3.10 | 3.00 |
| J                           | 0.013 | 0.10 | 0.05 |
| K                           | 1.00  | 1.30 | 1.10 |
| L                           | 0.35  | 0.55 | 0.40 |
| M                           | 0.10  | 0.20 | 0.15 |
| N                           | 0.70  | 0.80 | 0.75 |
| $\alpha$                    | 0°    | 8°   | —    |
| <b>All Dimensions in mm</b> |       |      |      |

## Suggested Pad Layout

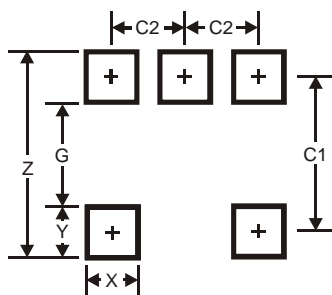

| Dimensions | Value (in mm) |
|------------|---------------|
| Z          | 3.20          |
| G          | 1.60          |
| X          | 0.55          |
| Y          | 0.80          |
| C1         | 2.40          |
| C2         | 0.95          |

### IMPORTANT NOTICE

DIODES INCORPORATED MAKES NO WARRANTY OF ANY KIND, EXPRESS OR IMPLIED, WITH REGARDS TO THIS DOCUMENT, INCLUDING, BUT NOT LIMITED TO, THE IMPLIED WARRANTIES OF MERCHANTABILITY AND FITNESS FOR A PARTICULAR PURPOSE (AND THEIR EQUIVALENTS UNDER THE LAWS OF ANY JURISDICTION).

Diodes Incorporated and its subsidiaries reserve the right to make modifications, enhancements, improvements, corrections or other changes without further notice to this document and any product described herein. Diodes Incorporated does not assume any liability arising out of the application or use of this document or any product described herein; neither does Diodes Incorporated convey any license under its patent or trademark rights, nor the rights of others. Any Customer or user of this document or products described herein in such applications shall assume all risks of such use and will agree to hold Diodes Incorporated and all the companies whose products are represented on Diodes Incorporated website, harmless against all damages.

Diodes Incorporated does not warrant or accept any liability whatsoever in respect of any products purchased through unauthorized sales channel. Should Customers purchase or use Diodes Incorporated products for any unintended or unauthorized application, Customers shall indemnify and hold Diodes Incorporated and its representatives harmless against all claims, damages, expenses, and attorney fees arising out of, directly or indirectly, any claim of personal injury or death associated with such unintended or unauthorized application.

Products described herein may be covered by one or more United States, international or foreign patents pending. Product names and markings noted herein may also be covered by one or more United States, international or foreign trademarks.

### LIFE SUPPORT

Diodes Incorporated products are specifically not authorized for use as critical components in life support devices or systems without the express written approval of the Chief Executive Officer of Diodes Incorporated. As used herein:

A. Life support devices or systems are devices or systems which:

1. are intended to implant into the body, or
2. support or sustain life and whose failure to perform when properly used in accordance with instructions for use provided in the labeling can be reasonably expected to result in significant injury to the user.

B. A critical component is any component in a life support device or system whose failure to perform can be reasonably expected to cause the failure of the life support device or to affect its safety or effectiveness.

Customers represent that they have all necessary expertise in the safety and regulatory ramifications of their life support devices or systems, and acknowledge and agree that they are solely responsible for all legal, regulatory and safety-related requirements concerning their products and any use of Diodes Incorporated products in such safety-critical, life support devices or systems, notwithstanding any devices- or systems-related information or support that may be provided by Diodes Incorporated. Further, Customers must fully indemnify Diodes Incorporated and its representatives against any damages arising out of the use of Diodes Incorporated products in such safety-critical, life support devices or systems.

Copyright © 2012, Diodes Incorporated

[www.diodes.com](http://www.diodes.com)



Компания «Life Electronics» занимается поставками электронных компонентов импортного и отечественного производства от производителей и со складов крупных дистрибьюторов Европы, Америки и Азии.

С конца 2013 года компания активно расширяет линейку поставок компонентов по направлению коаксиальный кабель, кварцевые генераторы и конденсаторы (керамические, пленочные, электролитические), за счёт заключения дистрибьюторских договоров

Мы предлагаем:

- Конкурентоспособные цены и скидки постоянным клиентам.
- Специальные условия для постоянных клиентов.
- Подбор аналогов.
- Поставку компонентов в любых объемах, удовлетворяющих вашим потребностям.
- Приемлемые сроки поставки, возможна ускоренная поставка.
- Доставку товара в любую точку России и стран СНГ.
- Комплексную поставку.
- Работу по проектам и поставку образцов.
- Формирование склада под заказчика.
- Сертификаты соответствия на поставляемую продукцию (по желанию клиента).
- Тестирование поставляемой продукции.
- Поставку компонентов, требующих военную и космическую приемку.
- Входной контроль качества.
- Наличие сертификата ISO.

В составе нашей компании организован Конструкторский отдел, призванный помогать разработчикам, и инженерам.

Конструкторский отдел помогает осуществить:

- Регистрацию проекта у производителя компонентов.
- Техническую поддержку проекта.
- Защиту от снятия компонента с производства.
- Оценку стоимости проекта по компонентам.
- Изготовление тестовой платы монтаж и пусконаладочные работы.



Тел: +7 (812) 336 43 04 (многоканальный)

Email: [org@lifeelectronics.ru](mailto:org@lifeelectronics.ru)