

Owner's Manual Model CT100

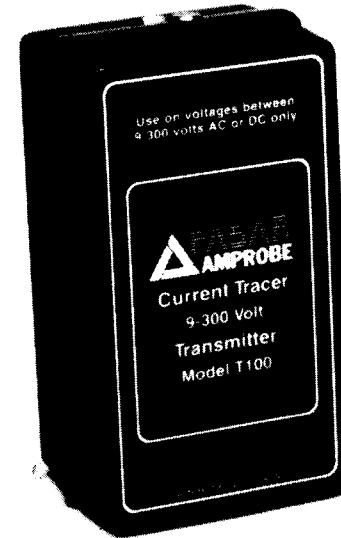

Current Tracer

Part No. 79-0001-10
6/95 REV. A

Made in USA
US Patent Nos.
4,491,785; 4,642,556;
4,775,832 and 4,804,907
Canadian Patent Nos.
1,219,911 and 1,219,912

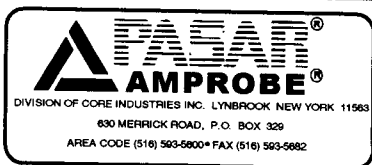

PRECAUTIONS

PRECAUTIONS FOR PERSONAL AND INSTRUMENT PROTECTION

IMPORTANT

1. Before using any electrical instrument, it should be checked to make certain it is operating properly.
2. In many instances, you will be working with dangerous levels of voltages and/or current, therefore it is important that you avoid direct contact with any uninsulated, current-carrying surfaces. Appropriate insulated gloves, safety glasses and protective clothing should be worn.
3. If the instrument is accidentally connected to a voltage beyond the range of the instrument, immediately remove the instrument from the circuit.
4. Keep the instrument in its carrying case when not in use.
5. Remove the battery when the probe will not be use for a period of time.

APPENDIX

LIMITED WARRANTY

Congratulations. You are now the owner of an Amprobe/Pasar instrument. It has been crafted according to quality standards and contains quality components and workmanship. This instrument has been inspected for proper operation of all of its functions. It has been tested by qualified, factory technicians according to the long established standards of Amprobe/Pasar.

Your Amprobe/Pasar instrument has a limited warranty against defective materials and/or workmanship for two years from the date of purchase provided the seal is unbroken or in the opinion of the factory the instrument has not been tampered with or taken apart. Should your instrument fail due to defective materials, and/or workmanship during the two year warranty period return it along with a copy of your dated bill of sale that must identify instrument by model and serial number.

For your protection, please use the instrument as soon as possible. If the unit is damaged or is ever in need of repair, please call Amprobe at (516) 593-5600 to obtain a Return of Materials Authorization (RMA) number. The unit must then be securely wrapped to prevent further damage in transit, insured and sent along with proof of purchase to:

**Service Division
AMPROBE INSTRUMENT
630 Merrick Road (For U.P.S.)
P.O. Box 329 (For P.P.)
Lynbrook, NY 11563-0329**

Outside of the U.S.A., your AMPROBE PASAR representative will assist you. For Technical Assistance call 1-800-477-VOLT.

Above limited warranty covers repair and replacement of instrument only and no other obligation is stated or implied. AMPROBE/PASAR shall not be liable for any loss or damage arising out of the use or misuse of this product.

TABLE OF CONTENTS

	Page
INTRODUCTION	
Theory of Operation	2
Components	3
APPLICATIONS	
Locating Circuit Breakers	6
Locating Open Breakers	8
Locating Wires in Walls	9
Locating Shorts	10
Locating Ground or Neutral Wires	11
Locating Shorts to Ground on Power Systems	12
Following Conduit	13
Tracing Coaxial Cable	14
Tracing Plumbing	14
APPENDIX	
Questions and Answers	15
Maintenance	17
Specifications	19
Warranty	20

INTRODUCTION

THEORY OF OPERATION

The Amprobe/Pasar Current Tracer allows fast, safe and easy tracing of energized conductors, on 9-300V AC/DC circuits, without turning off power or interrupting sensitive electronic equipment. The Current Tracer consists of a transmitter, and a probe. The transmitters draw short bursts of high frequency current from the power line. The probe senses the resulting magnetic field surrounding the conductors that supply power to the transmitter.

To operate, simply plug in or attach the transmitter to the conductor to be identified. The transmitter draws a 200mA load signal at a frequency one hundred times higher (6.25K) than the power line (60 Hz). The hand held probe containing custom filtering and signal conditioning networks will visually and audibly indicate which circuit is carrying the high frequency load signal.

The transmitter's signal is current drawn from the power source. Therefore, the signal will travel from the transmitter to the source of power (the power generating station) and back on the neutral, totally unaffected by distance. It's quick, easy and safe to use!

With the Current Tracer, you can trace any energized conductor, neutral line or ground line from any location in a facility back through main distribution panels, through transformers and switch gear. Without interrupting power, you can locate:

Circuit Breakers	Short Circuits
Feeder Lines	Conduit
Panel Boxes	Utility Boxes
Neutral and Ground Lines	Branch Lines

APPENDIX

SPECIFICATIONS

GENERAL

Operating Frequency	6.25 kHz
Operating Temperature	0°F to + 120°F
Shortage Temperature	-40°F + 150°F

T100 TRANSMITTER

Fuse	250V 1/4 amp, Normal 3 AG
Case	Flame Resistant ABS Plastic
Operating Voltage	9 to 300 Volts AC/DC
Operating Frequency	6250 Hertz (6.25 kHz)
Line Frequency Range	DC to 5 Hertz (5 kHz)
Maximum Load	200 ma. Peak at 110 Volts
Duty Cycle	Transmits every .164 seconds for .836 second.

P100 PROBE

Power	9 Volt Alkaline Battery
Battery Life	100 Hours (with normal use)
Case	Flame Resistant ABS Plastic

GAIN SETTINGS ON PROBE

Range Switch	Relative Gain
Wires	x1
Circuit Breakers	x2
Scan	x25

APPENDIX

TRANSMITTER FUSE REPLACEMENT

Disconnect instrument from all power sources before replacing fuse.

1. Using a small flat blade screwdriver, insert into slot located on fuse cover. Turn fuse cover 1/4 of a turn in a counter-clockwise direction. Fuse cover will pop out due to spring action.
2. Carefully pull the fuse cover away from transmitter case. The 250V, 1/4 amp, normal blow, 3 AG fuse should be attached to the fuse cover. If not, turn transmitter over so that fuse will fall out.
3. Place the replacement fuse into the fuse cover. Make sure that the replacement fuse is a 250V, 1/4 amp, normal blow, 3 AG fuse. A replacement fuse is provided in the instrument carrying case. Place the fuse and fuse cover combination into the transmitter case. Using a small screwdriver apply slight downward pressure and turn the fuse cover in the clockwise direction until it is felt to lock into position.

INTRODUCTION

T100 TRANSMITTER

The T100 transmitter is designed for tracing circuits with 9-300V AC/DC applied to them. It does this by drawing a high frequency load current from the power source, thus creating a traceable magnetic field around the conductors supplying its power. The transmitter houses a digital, crystal controlled circuit that never needs adjusting, and it will not interfere with sensitive electronic equipment on the line.

TRANSMITTER TEST POSITION

1. Plug the transmitter into any standard electrical outlet (see Figure 1). If there are no outlets available, use the pigtail connector provided in the instrument carrying case to connect the transmitter to any available voltage supply from 9-300V AC/DC (see Figure 2).
2. Verify that the L.E.D., located at the top of the transmitter, is flashing.
3. If the L.E.D. is not flashing and the voltage supply has been confirmed, check the fuse located on the L.E.D. end of the transmitter. (See fuse replacement on page 18.)
4. Repeat steps 1 and 2. When L.E.D. is flashing, this indicates that the T100 is functioning properly.
5. If the fuse is good and the L.E.D. on the T100 does not flash when attached to a voltage supply of 9-300V AC/DC, see the limited warranty for information on sending your unit in for repair.

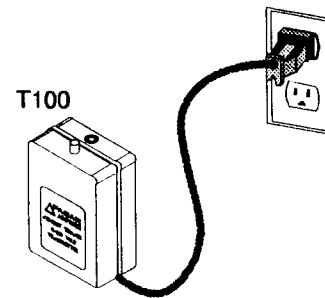

Figure 1

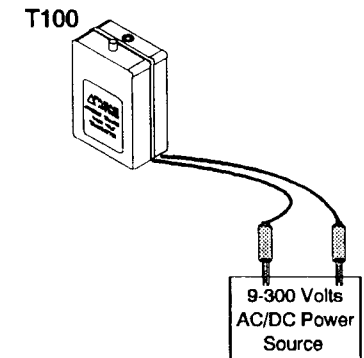

Figure 2

INTRODUCTION

P100 PROBE

The P100 probe is a tuned, magnetic field strength meter. When placed in close proximity (distance is dependent on range setting) of a conductor, or circuit breaker, which is in line with an Amprobe/Pasar transmitter, the magnetic sensor in the probe's tip will identify the proper conductor that is supplying power to that transmitter.

The probe is tuned to a 6.25 kHz frequency supplied in short continuous bursts by the Amprobe/Pasar transmitter. As the probe gets closer to the appropriate conductor, the 10 position L.E.D. display will indicate by lighting L.E.D.s in sequence from left to right. At the same time an audio signal will be heard in conjunction with visual indication on the display. The closer the probe is to the appropriate signal source the greater the visual and audio indication will be.

The probe's range and sensitivity will depend on the angle of the probe's tip in relation to the conductor being traced and the position of the range switch.

For maximum efficiency the tip of the probe should be oriented (as shown in Figure 3A) to the conductor being traced. Range settings are given on page 19. For battery replacement see page 18.

Figure 3A

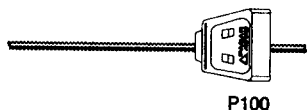
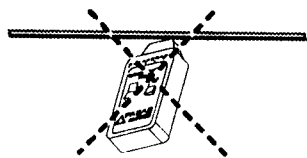

Figure 3B



APPENDIX

QUESTIONS & ANSWERS Cont.

15. Is the Current Tracer a quality product?

Yes, here are some of the Current Tracer's features:

- Digital Design
- Crystal Controlled Transmitters
- Special Proprietary Hybrid Circuit
- Advanced Signal Filtering Circuits
- High Noise Rejection
- Top Quality Components (Switches, ICs, L.E.D.s, etc.)
- Trim, Durable Design with Laminated Plastic Label (printed under plastic to eliminate wear)
- Transmitter Circuit Thermal Fuse Protected
- Probe Incorporates 3 Levels of Insulation (to protect the user)
- Manufactured in USA

MAINTENANCE

To replace the 9 volt battery located inside probe, model P100, use the following procedure:

1. Place probe on protective surface with the back facing upwards. Remove all four (4) Phillips machine screws from the back cover.
2. Carefully remove the old battery from the upper compartment. Care should be taken as to not extend battery cables farther than is necessary. Unclasp old battery from battery cables. Carefully press battery clip onto new battery.
3. Place the new battery into battery compartment. New battery should be placed into the exact same position as the old battery. Do not use excessive pressure in placing the battery into compartment, damage may occur to adjoining circuitry.
4. Replace cover and place all four (4) Phillips machine screws into proper position. Do not over tighten screws.

APPENDIX

QUESTIONS & ANSWERS Cont.

9. Will the Current Tracer trip a ground fault detector?

Ground fault detectors will trip when the transmitter is connected to ground.

10. What if I get the same reading on two different breakers?

Due to differing designs of circuit breakers and the unpredictability of internal wiring, the panel cover may need to be removed and the wires directly traced to accurately locate the correct breaker.

11. Is the probe sensitive to noise?

Noise on the power lines will have little effect on the Current Tracer probe. However, under extreme conditions, noise may cause L.E.D.s to light. This will not interfere with use of the probe because the transmitter's signal will continue to pulse at its normal rate while noise will remain at a constant level or a flicker without a pulse. In rare situations, you may have to turn off the equipment causing the noise. You can use the P100 probe itself to trace the cause of the noise.

12. Can I connect the transmitter at the fuse or breaker panel and identify the receptacle for that circuit?

NO! The transmitter draws current from the source of power. The signal will only exist on the conductors between the source of power and the transmitter.

13. What is the maximum distance from a conductor that the probe can detect a signal?

In the most sensitive position (SCAN), the L.E.D.s will begin to illuminate approximately 1-2 feet from the conductor. A full scale L.E.D. reading will be achieved at approximately 4-5 inches from the conductor. An audio indication will begin prior to the illumination.

14. What is the life expectancy of this unit?

The Current Tracer is made with only high quality components. This unit should last well over five years with normal use.

INTRODUCTION

PROBE TEST POSITION

1. Attach a known good T100 transmitter to a power source of 9-300V AC/DC. The L.E.D. located on top of the transmitter should be flashing.
2. Set the range switch of the P100 to the *Circuit Breakers* position. Hold the probe at a 90° angle to the front of the functioning transmitter. With the tip pointed at the middle of the transmitter, a visual display of eight (8) to ten (10) L.E.D.s and a clear audio tone will be indicated.
3. If the visual display is less than eight (8) L.E.D.s or if there is not a clear audio tone, the nine (9) volt battery located inside the probe may need replacing (see battery replacement on page 17).
4. Repeat step 2. If the unit does not function properly, see the limited warranty for information on sending your unit in for repair. If the unit does indicate between the 8th and 10th L.E.D. and has a clear audio tone during that time, then the unit is functioning properly.

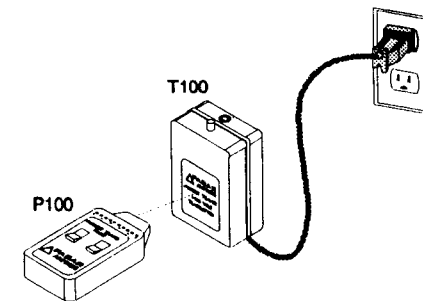

Figure 4

APPLICATIONS

LOCATING CIRCUIT BREAKERS

In areas where loss of power to a circuit will not cause damage, you can locate a circuit breaker without removing the panel cover.

1. Plug the T100 transmitter into an outlet.
2. Press the probe's Range Switch to SCAN.
3. Press the probe's ON/OFF Switch to ON.
4. Ensure that the probe is operational by holding it perpendicular to the transmitter and observing the L.E.D.s blink.
5. Hold the probe's tip to the distribution panel that the breaker is thought to be in and observe the probe's signal strength. The appropriate distribution panel produces the strongest signal.
6. Open the circuit breaker distribution panel door.
7. Press the probe's Range Switch to CIRCUIT BREAKER.
8. Press the probe's ON/OFF Switch to ON.
9. Hold the probe's tip to each circuit breaker as shown. The appropriate circuit breaker produces the strongest signal.

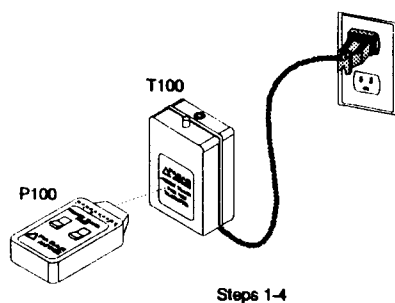

Figure 5

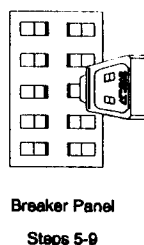

Figure 6

APPENDIX

QUESTIONS & ANSWERS

1. **What type of power does the transmitter require to operate?**
The T100 transmitter will operate at voltages from 9-300V AC/DC.
2. **What happens if I connect the transmitter to the wrong voltage?**
There is a fuse that will protect the transmitter from damage.
3. **Why not put a battery in the transmitter so that it could be used without power to the line?**
If the transmitter were battery operated, it would be injecting a signal into the line instead of drawing the signal from the line. An injected signal travels through out the system making it difficult to locate a particular circuit breaker or line.
4. **How far will the signal travel?**
The transmitter signal is current drawn from the power line. Therefore, it will travel from the transmitter to the source of power and back on the neutral, totally unaffected by distance.
5. **Is the transmitter signal affected by transformers?**
The transmitter signal can pass through transformers, and is affected only by the step-up or step-down ratio of the transformer. For example, if the signal passes through a 2 to 1 step-down transformer, the signal will be reduced by one half.
6. **What about neutral lines?**
Neutral lines may also be traced since the magnetic signal normally returns to the transmitter on the neutral line.
7. **Will the transmitter signal affect any sensitive electronic equipment?**
NO! This signal is only 200mA peak and produces less noise than a home dimmer switch. Only the Current Tracer probe can detect this signal.
8. **Why do I have to make a separate ground connection to the transmitter when tracing conductors through walls, floors or conduit?**
The transmitter causes current to flow in the "hot" conductor and the neutral or ground conductor. These two currents are alike but flow in opposite directions, therefore they create opposing electromagnetic fields. When the two conductors are within close proximity, their electromagnetic fields tend to cancel each other. This reduces the field strength and decreases the probe's ability to detect either conductor.

APPLICATIONS

TRACING COAXIAL CABLE

1. Clip one lead of the T100 transmitter to the shield on the coaxial cable.
2. Clip the other lead to a grounded 9-300V AC/DC power source.
3. Follow the transmitter's signal as explained in the LOCATING WIRES IN WALLS section.

(Note: Make sure the shield on the coaxial cable is at ground potential by using an ohm meter or other resistance measuring device.)

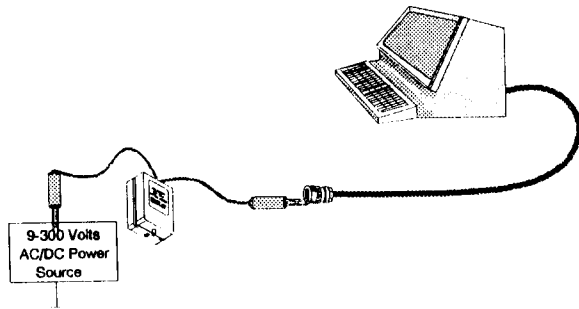

Figure 15

TRACING PLUMBING

1. Clip one lead of the T100 transmitter to the pipe you want to trace.
2. Clip the other lead to a grounded 9-300V AC/DC power source.
3. Press the probe's Range Switch to SCAN.
4. Press the probe's ON/OFF Switch to ON.
5. Hold the probe's tip to each pipe. The appropriate pipe will produce the strongest signal.

(Note: Remember you are tracing the current path to ground. If the pipe has many ground connections, the signal may be confusing. The larger the diameter of the pipe, the less the signal strength will be.)

APPLICATIONS

If you are working in a hospital, industrial setting, around computers, or sensitive electronic equipment, you can locate the appropriate circuit breaker without turning off power to the other circuits. Verification of results of the application on page 6 may be important so that critical power to equipment is not interrupted.

1. Follow steps 1 through 5.
2. Remove the cover of the circuit breaker box.
3. Press the probe's Range Switch to WIRES.
4. Press the ON/OFF Switch to ON.
5. Hold the probe's tip to the wires leading to each circuit breaker. The appropriate wire produces the strongest signal.
6. Visually follow the wire to the appropriate circuit breaker.

(Note: The probe actually detects the electromagnetic field surrounding the conductors that supply power to the transmitter. This is caused by the high frequency load signal the transmitter draws. The circuit breaker itself does not cause the signal.)

APPLICATIONS

LOCATING OPEN BREAKERS

1. Plug the pigtail connector into the T100 transmitter. Clip one of the leads to the neutral conductor at the location that does not have power.
2. Clip the other lead to a grounded 9-300V AC/DC power source.
3. Press the probe's Range Switch to WIRES.
4. Press the probe's ON/OFF Switch to ON.
5. Hold the probe and trace the neutral wire to the appropriate distribution panel.
6. Remove the panel cover.
7. Visually locate the neutral's corresponding hot wire and circuit breaker. Use a voltmeter to determine which breaker is open if there is more than one hot line in the conduit.

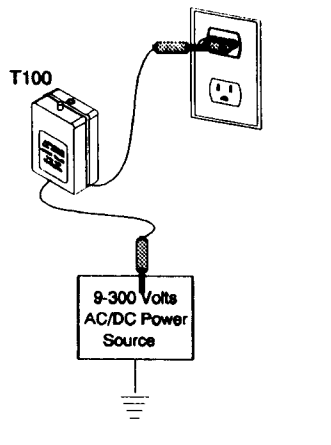

Figure 7

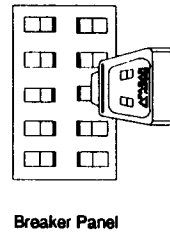

Figure 8

APPLICATIONS

FOLLOWING CONDUIT

1. Plug the pigtail connector into the T100 transmitter.
2. Clip one lead to a separate earth ground such as a water pipe or sprinkler system.
3. Clip the other lead of the transmitter to the hot conductor.
4. Follow the transmitter's signal as explained in the LOCATING WIRES IN WALLS section.

(Note: Since the feeder panel may radiate a magnetic signal to nearby conduit, make sure the probe is always more than 5 feet from the circuit breaker box. Also, although plastic and aluminum conduit do not affect the signal, thick steel conduit will reduce the signal strength.)

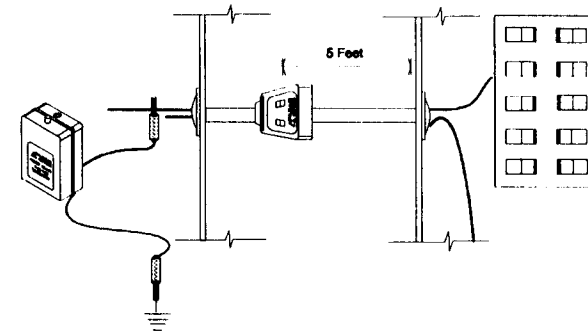

Figure 14

APPLICATIONS

LOCATING SHORTS TO GROUND ON POWER SYSTEMS

1. Clip one lead of the T100 transmitter to the shorted conductor at some point in the system or power line.
2. Clip the other lead to a grounded 9-300V AC/DC power source that is connected to ground.
3. Press the probe's Range Switch to SCAN.
4. Press the ON/OFF Switch to ON and test the transmitter signal.
5. Trace the probe's signal along the wire in both directions from the T100 transmitter. The signal will go directly to the short.

(Note: Connect the ground path far enough away from the shorted conductor so that it does not interfere with the signal. For example, when tracing a signal inside conduit, you would not want to use the conduit as a ground path.)

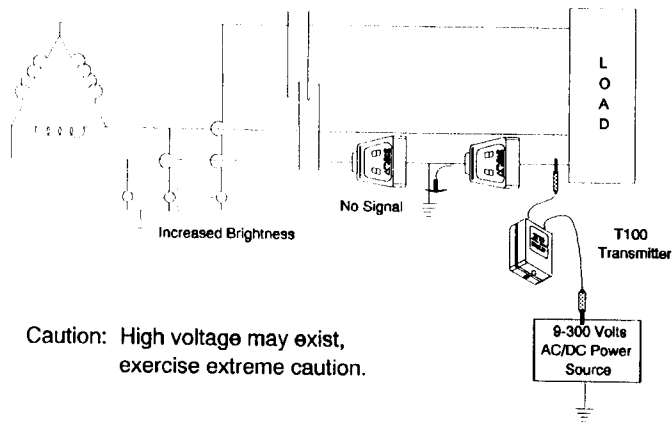

Figure 13

APPLICATIONS

LOCATING WIRES IN WALLS

1. Plug the pigtail connector into the T100 transmitter.
2. Clip one lead to a separate earth ground such as a water pipe.
3. Clip the other lead to the hot conductor.
4. Press the probe's Range Switch to SCAN.
5. Press the ON/OFF Switch to ON.
6. Hold the probe's tip close to the wall or floor where you suspect the conductor to be located.
7. Sweep the probe across large areas until the probe's signal locates the conductor.

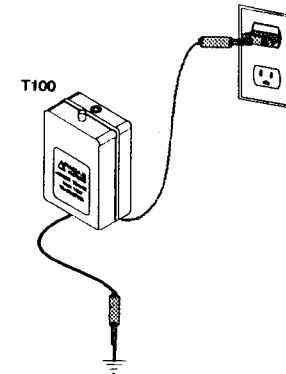

Figure 9

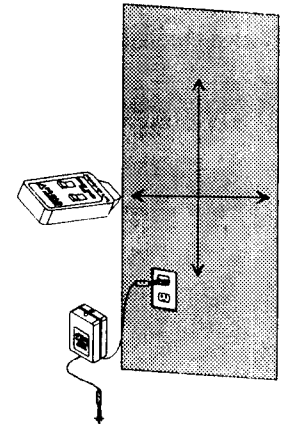

Figure 10

Caution: Always connect the transmitter to ground first.

(Note: This procedure may be used for tracing individual wires in bundles, etc.)

APPLICATIONS

LOCATING SHORTS

1. Find the affected breaker panel and make sure the switch is in the OFF position.
2. Plug the pigtail connector into the T100 transmitter.
3. Clip one lead to the shorted power line.
4. Clip the other lead to the hot conductor of an adjacent breaker or any source of power that is connected to ground.
5. Press the probe's Range Switch to SCAN.
6. Press the ON/OFF Switch to ON.
7. Hold the probe's tip close to the shorted wire.
8. Trace the wire until the signal suddenly stops. This is the location of the short.

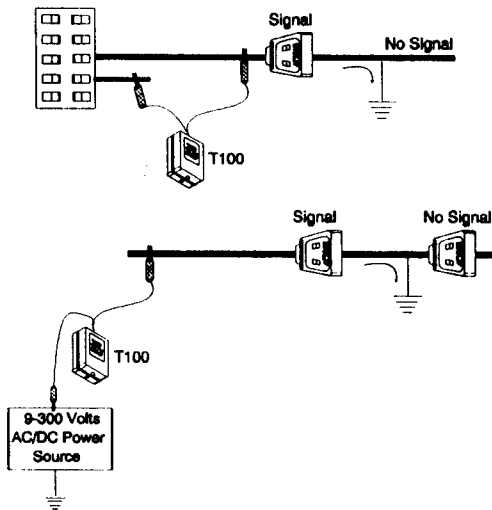

Figure 11

(Note: Since the signal should be fairly constant until you locate the short, you may have to adjust the Range Switch to a more selective gain level setting such as WIRES.)

APPLICATIONS

LOCATING GROUND OR NEUTRAL WIRES

1. Plug the pigtail connector into the T100 transmitter.
2. Clip one lead to the outlet ground or neutral.
3. Clip the other lead to the hot side of a grounded 9-300V AC/DC power source. An extension cord that is plugged into a powered outlet works well. The transmitter's L.E.D. should blink to indicate that it is operational.
4. Press the probe's Range Switch to SCAN.
5. Press the ON/OFF Switch to ON. Always check that you are getting a full scale reading on the wire to the transmitter with the probe in the WIRES position.
6. Follow the probe's signal to the desired location.

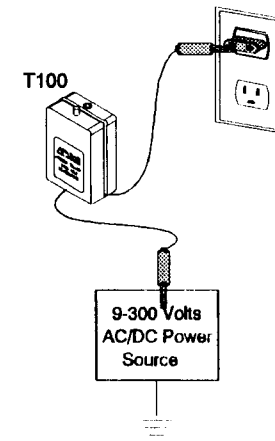

Figure 12

Компания «Life Electronics» занимается поставками электронных компонентов импортного и отечественного производства от производителей и со складов крупных дистрибьюторов Европы, Америки и Азии.

С конца 2013 года компания активно расширяет линейку поставок компонентов по направлению коаксиальный кабель, кварцевые генераторы и конденсаторы (керамические, пленочные, электролитические), за счёт заключения дистрибьюторских договоров

Мы предлагаем:

- Конкуренеспособные цены и скидки постоянным клиентам.
- Специальные условия для постоянных клиентов.
- Подбор аналогов.
- Поставку компонентов в любых объемах, удовлетворяющих вашим потребностям.
- Приемлемые сроки поставки, возможна ускоренная поставка.
- Доставку товара в любую точку России и стран СНГ.
- Комплексную поставку.
- Работу по проектам и поставку образцов.
- Формирование склада под заказчика.
- Сертификаты соответствия на поставляемую продукцию (по желанию клиента).
- Тестирование поставляемой продукции.
- Поставку компонентов, требующих военную и космическую приемку.
- Входной контроль качества.
- Наличие сертификата ISO.

В составе нашей компании организован Конструкторский отдел, призванный помогать разработчикам, и инженерам.

Конструкторский отдел помогает осуществить:

- Регистрацию проекта у производителя компонентов.
- Техническую поддержку проекта.
- Защиту от снятия компонента с производства.
- Оценку стоимости проекта по компонентам.
- Изготовление тестовой платы монтаж и пусконаладочные работы.



Тел: +7 (812) 336 43 04 (многоканальный)

Email: org@lifeelectronics.ru