

# HCPL-3140, HCPL-0314

## 0.4 Amp Output Current IGBT Gate Drive Optocoupler



### Data Sheet



#### Description

The HCPL-3140/HCPL-0314 family of devices consists of a GaAsP LED optically coupled to an integrated circuit with a power output stage. These optocouplers are ideally suited for driving power IGBTs and MOSFETs used in motor control inverter applications. The high operating voltage range of the output stage provides the drive voltages required by gate controlled devices. The voltage and current supplied by this optocoupler makes it ideally suited for directly driving small or medium power IGBTs. For IGBTs with higher ratings, the HCPL-3150 (0.5 A) or HCPL-3120 (2.0 A) opto-couplers can be used.

#### Functional Diagram



Truth Table

LED	V <sub>O</sub>
OFF	LOW
ON	HIGH

A 0.1 μF bypass capacitor must be connected between pins V<sub>CC</sub> and V<sub>EE</sub>.

#### Features

- 0.4 A minimum peak output current
- High speed response:  
0.7 μs maximum propagation delay over temperature range
- Ultra high CMR: minimum 25 kV/μs at V<sub>CM</sub> = 1 kV
- Bootstrappable supply current: maximum 3 mA
- Wide operating temperature range: -40°C to 100°C
- Wide V<sub>CC</sub> operating range: 10 V to 30 V over temp. range
- Available in DIP8 and SO8 package
- Safety approvals: UL approval, 3750 V<sub>rms</sub> for 1 minute. CSA approval. IEC/EN/DIN EN 60747-5-2 approval V<sub>IORM</sub> = 630 V<sub>peak</sub> (HCPL-3140)

#### Applications

- Isolated IGBT/Power MOSFET gate drive
- AC and brushless DC motor drives
- Inverters for home appliances
- Industrial inverters
- Switch Mode Power Supplies (SMPS)

CAUTION: It is advised that normal static precautions be taken in handling and assembly of this component to prevent damage and/or degradation which may be induced by ESD.

## Ordering Information

HCPL-3140 and HCPL-0314 are UL Recognized with 3750 Vrms for 1 minute per UL1577.

Part Number	Option		Package	Surface Mount	Gull Wing	Tape & Reel	IEC/EN/DIN EN 60747-5-2	Quantity
	RoHS Compliant	Non RoHS Compliant						
HCPL-3140	-000E	No option	300 mil DIP-8					50 per tube
	-300E	#300		X	X			50 per tube
	-500E	#500		X	X	X		1000 per reel
	-060E	#060					X	50 per tube
	-360E	#360		X	X		X	50 per tube
	-560E	#560		X	X	X	X	1000 per reel
HCPL-0314	-000E	No option	SO-8	X				100 per tube
	-500E	#500		X		X		1500 per reel
	-060E	#060		X			X	100 per tube
	-560E	#560		X		X	X	1500 per reel

To order, choose a part number from the part number column and combine with the desired option from the option column to form an order entry.

Example 1:

HCPL-3140-560E to order product of 300 mil DIP Gull Wing Surface Mount package in Tape and Reel packaging with IEC/EN/DIN EN 60747-5-2 Safety Approval in RoHS compliant.

Example 2:

HCPL-3140 to order product of 300 mil DIP package in tube packaging and non RoHS compliant.

Option datasheets are available. Contact your Avago sales representative or authorized distributor for information.

Remarks: The notation '#XXX' is used for existing products, while (new) products launched since 15<sup>th</sup> July 2001 and RoHS compliant option will use '-XXXE'.

## Package Outline Drawings

### HCPL-3140 Standard DIP Package



DIMENSIONS IN MILLIMETERS AND (INCHES).  
 \* MARKING CODE LETTER FOR OPTION NUMBERS  
 "V" = OPTION 060  
 OPTION NUMBERS 300 AND 500 NOT MARKED.

NOTE: FLOATING LEAD PROTRUSION IS 0.25 mm (10 mils) MAX.

### HCPL-3140 Gull Wing Surface Mount Option 300 Outline Drawing



### HCPL-0314 Small Outline SO-8 Package

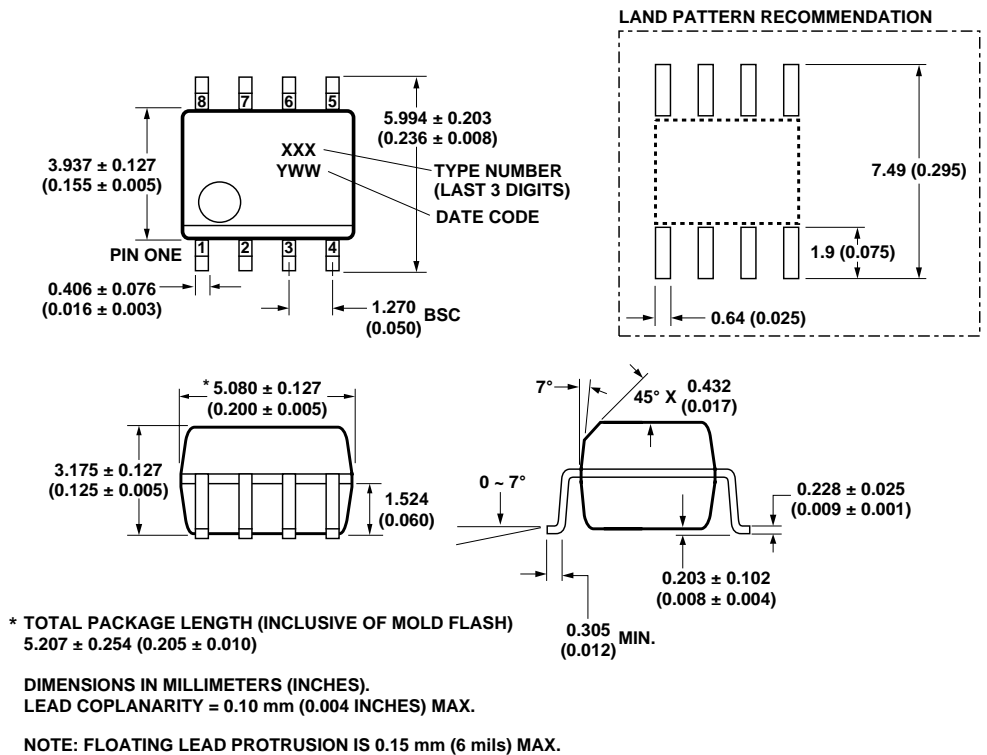

## Solder Reflow Temperature Profile

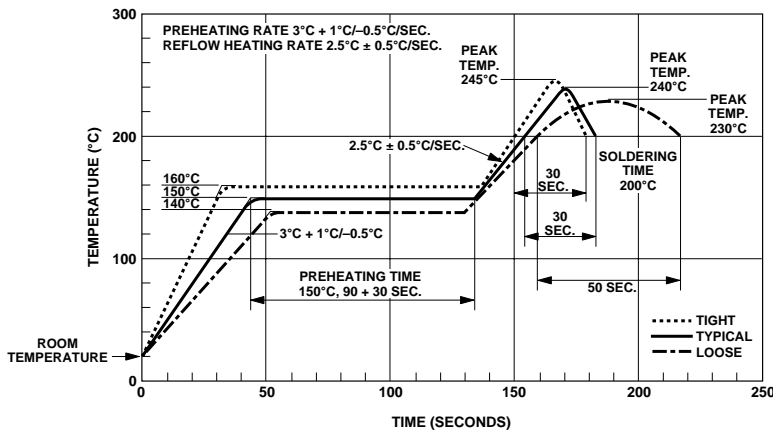

Note: Non-halide flux should be used.

## Recommended Pb-Free IR Profile

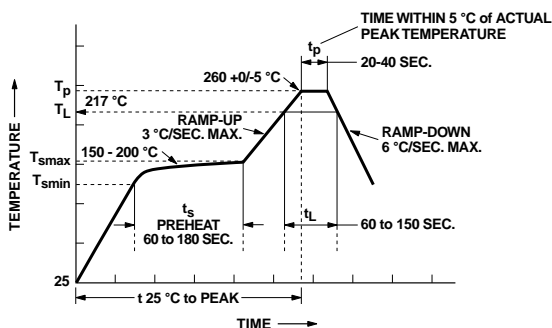

NOTES:  
THE TIME FROM 25 °C TO PEAK TEMPERATURE = 8 MINUTES MAX.  
 $T_{smax} = 200\text{ °C}$ ,  $T_{smin} = 150\text{ °C}$

Note: Non-halide flux should be used.

## Regulatory Information

The HCPL-3140/HCPL-0314 have been approved by the following organizations:

### IEC/EN/DIN EN 60747-5-2

Approved under:  
IEC 60747-5-2:1997 + A1:2002  
EN 60747-5-2:2001 + A1:2002  
DIN EN 60747-5-2 (VDE 0884  
Teil 2):2003-01  
(Option 060 only)

### UL

Approval under UL 1577,  
component recognition program  
up to  $V_{ISO} = 2500 V_{rms}$ . File  
E55361.

### CSA

Approval under CSA Component  
Acceptance Notice #5, File CA  
88324.

## IEC/EN/DIN EN 60747-5-2 Insulation Characteristics (HCPL-3140 Option 060)

Description	Symbol	Characteristic	Unit
Installation classification per DIN VDE 0110/1.89, Table 1 for rated mains voltage $\leq 150 V_{rms}$ for rated mains voltage $\leq 300 V_{rms}$ for rated mains voltage $\leq 600 V_{rms}$		I - IV I - III I-II	
Climatic Classification		55/100/21	
Pollution Degree (DIN VDE 0110/1.89)		2	
Maximum Working Insulation Voltage	$V_{IORM}$	630	$V_{peak}$
Input to Output Test Voltage, Method b* $V_{IORM} \times 1.875 = V_{PR}$ , 100% Production Test with $t_m = 1\text{ sec}$ , Partial discharge $< 5\text{ pC}$	$V_{PR}$	1181	$V_{peak}$
Input to Output Test Voltage, Method a* $V_{IORM} \times 1.5 = V_{PR}$ , Type and Sample Test, $t_m = 60\text{ sec}$ , Partial discharge $< 5\text{ pC}$	$V_{PR}$	945	$V_{peak}$
Highest Allowable Overvoltage (Transient Overvoltage $t_{inj} = 10\text{ sec}$ )	$V_{IOTM}$	6000	$V_{peak}$
Safety-limiting values - maximum values allowed in the event of a failure.			
Case Temperature	$T_S$	175	°C
Input Current**	$I_{S,INPUT}$	230	mA
Output Power**	$P_{S,OUTPUT}$	600	mW
Insulation Resistance at $T_S$ , $V_{IO} = 500\text{ V}$	$R_S$	$> 10^9$	$\Omega$

\* Refer to the optocoupler section of the Isolation and Control Components Designer's Catalog, under Product Safety Regulations section IEC/EN/DIN EN 60747-5-2 for a detailed description of Method a and Method b partial discharge test profiles.

\*\* Refer to the following figure for dependence of  $P_S$  and  $I_S$  on ambient temperature.

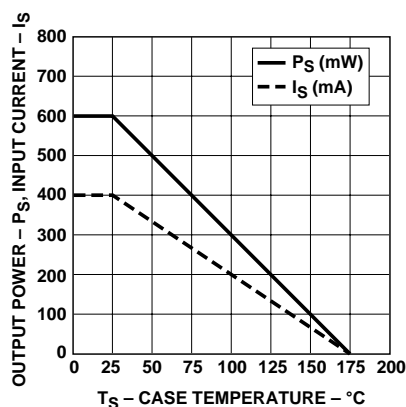

### Insulation and Safety Related Specifications

Parameter	Symbol	HCPL-3140	HCPL-0314	Units	Conditions
Minimum External Air Gap (Clearance)	L(101)	7.1	4.9	mm	Measured from input terminals to output terminals, shortest distance through air.
Minimum External Tracking (Creepage)	L(102)	7.4	4.8	mm	Measured from input terminals to output terminals, shortest distance path along body.
Minimum Internal Plastic Gap (Internal Clearance)		0.08	0.08	mm	Through insulation distance conductor to conductor, usually the straight line distance thickness between the emitter and detector.
Tracking Resistance (Comparative Tracking Index)	CTI	>175	>175	V	DIN IEC 112/VDE 0303 Part 1
Isolation Group		IIIa	IIIa		Material Group (DIN VDE 0110, 1/89, Table 1)

### Absolute Maximum Ratings

Parameter	Symbol	Min.	Max.	Units	Note
Storage Temperature	T <sub>S</sub>	-55	125	°C	
Operating Temperature	T <sub>A</sub>	-40	100	°C	
Average Input Current	I <sub>F(AVG)</sub>		25	mA	1
Peak Transient Input Current (<1 μs pulse width, 300pps)	I <sub>F(TRAN)</sub>		1.0	A	
Reverse Input Voltage	V <sub>R</sub>		5	V	
"High" Peak Output Current	I <sub>OH(PEAK)</sub>		0.6	A	2
"Low" Peak Output Current	I <sub>OL(PEAK)</sub>		0.6	A	2
Supply Voltage	V <sub>CC-V<sub>EE</sub></sub>	-0.5	35	V	
Output Voltage	V <sub>O(PEAK)</sub>	-0.5	V <sub>CC</sub>	V	
Output Power Dissipation	P <sub>O</sub>		250	mW	3
Input Power Dissipation	P <sub>I</sub>		45	mW	4
Lead Solder Temperature		260°C for 10 sec., 1.6 mm below seating plane			
Solder Reflow Temperature Profile		See Package Outline Drawings section			

## Recommended Operating Conditions

Parameter	Symbol	Min.	Max.	Units	Note
Power Supply	$V_{CC}-V_{EE}$	10	30	V	
Input Current (ON)	$I_{F(ON)}$	8	12	mA	
Input Voltage (OFF)	$V_{F(OFF)}$	-3.6	0.8	V	
Operating Temperature	$T_A$	-40	100	°C	

## Electrical Specifications (DC)

Over recommended operating conditions unless otherwise specified.

Parameter	Symbol	Min.	Typ.	Max.	Units	Test Conditions	Fig.	Note
High Level Output Current	$I_{OH}$	0.2			A	$V_o = V_{CC} - 4$	2	5
		0.4	0.5			$V_o = V_{CC} - 10$	3	2
Low Level Output Current	$I_{OL}$	0.2	0.4		A	$V_o = V_{EE} + 2.5$	5	5
		0.4	0.5			$V_o = V_{EE} + 10$	6	2
High Level Output Voltage	$V_{OH}$	$V_{CC} - 4$	$V_{CC} - 1.8$		V	$I_o = -100$ mA	1	6,7
Low Level Output Voltage	$V_{OL}$		0.4	1	V	$I_o = 100$ mA	4	
High Level Supply Current	$I_{CCH}$		0.7	3	mA	$I_o = 0$ mA	7,8	14
Low Level Supply Current	$I_{CCL}$		1.2	3	mA	$I_o = 0$ mA		
Threshold Input Current Low to High	$I_{FLH}$			7	mA	$I_o = 0$ mA, $V_o > 5$ V		9,15
Threshold Input Voltage High to Low	$V_{FHL}$	0.8			V			
Input Forward Voltage	$V_F$	1.2	1.5	1.8	V	$I_F = 10$ mA	16	
Temperature Coefficient of Input Forward Voltage	$DV_F/DT_A$		-1.6		mV/°C			
Input Reverse Breakdown Voltage	$BV_R$	5			V	$I_R = 10$ $\mu$ A		
Input Capacitance	$C_{IN}$		60		pF	$f = 1$ MHz, $V_F = 0$ V		

## Switching Specifications (AC)

Over recommended operating conditions unless otherwise specified.

Parameter	Symbol	Min.	Typ.	Max.	Units	Test Conditions	Fig.	Note
Propagation Delay Time to High Output Level	$t_{PLH}$	0.1	0.2	0.7	$\mu\text{s}$	$R_g = 47 \Omega$ , $C_g = 3 \text{ nF}$ ,	10,11, 12,13,	14
Propagation Delay Time to Low Output Level	$t_{PHL}$	0.1	0.3	0.7	$\mu\text{s}$	$f = 10 \text{ kHz}$ , Duty Cycle =	14,17	
Propagation Delay Difference Between Any Two Parts or Channels	PDD	-0.5		0.5	$\mu\text{s}$	50%, $I_F = 8 \text{ mA}$ , $V_{CC} = 30 \text{ V}$		10
Rise Time	$t_R$		50		ns			
Fall Time	$t_F$		50		ns			
Output High Level Common Mode Transient Immunity	$ CM_H $	25	35		$\text{kV}/\mu\text{s}$	$T_A = 25^\circ\text{C}$ , $V_{CM} = 1 \text{ kV}$	18	11
Output Low Level Common Mode Transient Immunity	$ CM_L $	25	35		$\text{kV}/\mu\text{s}$		18	12

## Package Characteristics

Parameter	Symbol	Min.	Typ.	Max.	Units	Test Conditions	Fig.	Note
Input-Output Momentary Withstand Voltage	$V_{ISO}$	3750			$V_{rms}$	$T_A = 25^\circ\text{C}$ , $RH < 50\%$ for		8,9
Input-Output Resistance	$R_{I-O}$		$10^{12}$		$\Omega$	$V_{I-O} = 500 \text{ V}$		9
Input-Output Capacitance	$C_{I-O}$		0.6		pF	Freq=1 MHz		

### Notes:

- Derate linearly above  $70^\circ\text{C}$  free air temperature at a rate of  $0.3 \text{ mA}/^\circ\text{C}$ .
- Maximum pulse width =  $10 \mu\text{s}$ , maximum duty cycle = 0.2%. This value is intended to allow for component tolerances for designs with  $I_O$  peak minimum =  $0.4 \text{ A}$ . See Application section for additional details on limiting  $I_{OL}$  peak.
- Derate linearly above  $85^\circ\text{C}$ , free air temperature at the rate of  $4.0 \text{ mW}/^\circ\text{C}$ .
- Input power dissipation does not require derating.
- Maximum pulse width =  $50 \mu\text{s}$ , maximum duty cycle = 0.5%.
- In this test,  $V_{OH}$  is measured with a DC load current. When driving capacitive load  $V_{OH}$  will approach  $V_{CC}$  as  $I_{OH}$  approaches zero amps.
- Maximum pulse width =  $1 \text{ ms}$ , maximum duty cycle = 20%.
- In accordance with UL 1577, each optocoupler is proof tested by applying an insulation test voltage  $\geq 4500 V_{rms}$  for 1 second (leakage detection current limit  $I_{I-O} \leq 5 \mu\text{A}$ ). This test is performed before 100% production test for partial discharge (method B) shown in the IEC/EN/DIN EN 60747-5-2 Insulation Characteristics Table, if applicable.
- Device considered a two-terminal device: pins on input side shorted together and pins on output side shorted together.
- PDD is the difference between  $t_{PHL}$  and  $t_{PLH}$  between any two parts or channels under the same test conditions.
- Common mode transient immunity in the high state is the maximum tolerable  $|dV_{CM}/dt|$  of the common mode pulse  $V_{CM}$  to assure that the output will remain in the high state (i.e.  $V_o > 6.0 \text{ V}$ ).
- Common mode transient immunity in a low state is the maximum tolerable  $|dV_{CM}/dt|$  of the common mode pulse,  $V_{CM}$ , to assure that the output will remain in a low state (i.e.  $V_o < 1.0 \text{ V}$ ).
- This load condition approximates the gate load of a 1200 V/25 A IGBT.
- The power supply current increases when operating frequency and  $Q_g$  of the driven IGBT increases.



Figure 1.  $V_{OH}$  vs. temperature.



Figure 2.  $I_{OH}$  vs. temperature.



Figure 3.  $V_{OH}$  vs.  $I_{OH}$ .



Figure 4.  $V_{OL}$  vs. temperature.



Figure 5.  $I_{OL}$  vs. temperature.

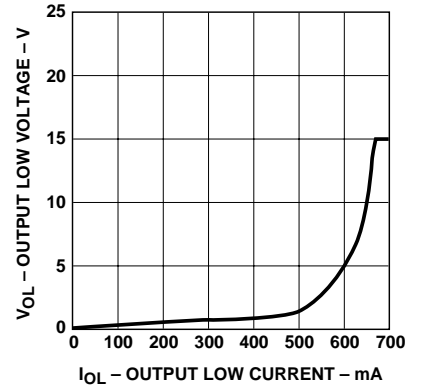

Figure 6.  $V_{OL}$  vs.  $I_{OL}$ .



Figure 7.  $I_{CC}$  vs. temperature.

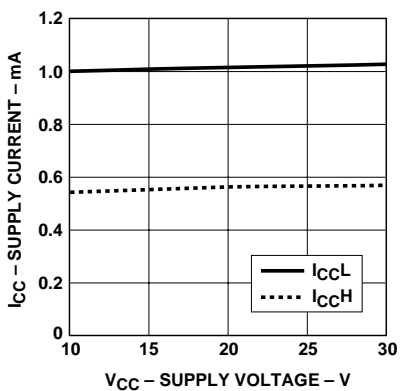

Figure 8.  $I_{CC}$  vs.  $V_{CC}$ .



Figure 9.  $I_{FLH}$  vs. temperature.





Figure 10. Propagation delay vs.  $V_{CC}$ .



Figure 11. Propagation delay vs.  $I_F$ .



Figure 12. Propagation delay vs. temperature.



Figure 13. Propagation delay vs.  $R_g$ .



Figure 14. Propagation delay vs.  $C_g$ .



Figure 15. Transfer characteristics.

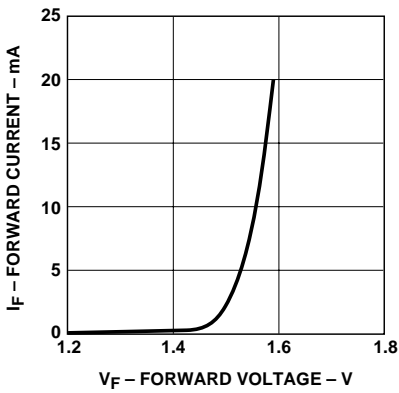

Figure 16. Input current vs. forward voltage.



Figure 17. Propagation delay test circuit and waveforms.



Figure 18. CMR test circuit and waveforms.

**Applications Information**  
**Eliminating Negative IGBT Gate Drive**

To keep the IGBT firmly off, the HCPL-3140/HCPL-0314 has a very low maximum  $V_{OL}$  specification of 1.0 V. Minimizing  $R_g$  and the lead inductance from the HCPL-3140/HCPL-0314 to the IGBT gate and emitter (possibly by mounting the

HCPL-3140/HCPL-0314 on a small PC board directly above the IGBT) can eliminate the need for negative IGBT gate drive in many applications as shown in Figure 19. Care should be taken with such a PC board design to avoid routing the IGBT collector or emitter traces close to the HCPL-3140/HCPL-0314 input as this can result in unwanted

coupling of transient signals into the input of HCPL-3140/HCPL-0314 and degrade performance. (If the IGBT drain must be routed near the HCPL-3140/HCPL-0314 input, then the LED should be reverse biased when in the off state, to prevent the transient signals coupled from the IGBT drain from turning on the HCPL-3140/HCPL-0314.)



Figure 19. Recommended LED drive and application circuit for HCPL-3140/HCPL-0314.

### Selecting the Gate Resistor (Rg)

Step 1: Calculate R<sub>g</sub> minimum from the I<sub>OL</sub> peak specification. The IGBT and R<sub>g</sub> in Figure 19 can be analyzed as a simple RC circuit with a voltage supplied by the HCPL-3140/HCPL-0314.

$$\begin{aligned} R_g &\geq \frac{V_{CC} - V_{OL}}{I_{OLPEAK}} \\ &= \frac{24 \text{ V} - 5 \text{ V}}{0.6 \text{ A}} \\ &= 32 \Omega \end{aligned}$$

The V<sub>OL</sub> value of 5 V in the previous equation is the V<sub>OL</sub> at the peak current of 0.6A. (See Figure 6).

Step 2: Check the HCPL-3140/HCPL-0314 power dissipation and increase R<sub>g</sub> if necessary. The HCPL-3140/HCPL-0314 total power dissipation (P<sub>T</sub>) is equal to the sum of the emitter power (P<sub>E</sub>) and the output power (P<sub>O</sub>).

$$P_T = P_E + P_O$$

$$P_E = I_F \cdot V_F \cdot \text{Duty Cycle}$$

$$\begin{aligned} P_O &= P_{O(BIAS)} + P_{O(SWITCHING)} = I_{CC} \cdot V_{CC} + E_{SW}(R_g, Q_g) \cdot f \\ &= (I_{CCBIAS} + K_{ICC} \cdot Q_g \cdot f) \cdot V_{CC} + E_{SW}(R_g, Q_g) \cdot f \end{aligned}$$

where  $K_{ICC} \cdot Q_g \cdot f$  is the increase in I<sub>CC</sub> due to switching and K<sub>ICC</sub> is a constant of 0.001 mA/(nC\*kHz). For the circuit in Figure 19 with I<sub>F</sub> (worst case) = 10 mA, R<sub>g</sub> = 32 Ω, Max Duty Cycle = 80%, Q<sub>g</sub> = 100 nC, f = 20 kHz and T<sub>AMAX</sub> = 85°C:

$$P_E = 10 \text{ mA} \cdot 1.8 \text{ V} \cdot 0.8 = 14 \text{ mW}$$

$$P_O = (3 \text{ mA} + (0.001 \text{ mA}/(\text{nC} \cdot \text{kHz})) \cdot 20 \text{ kHz} \cdot 100 \text{ nC}) \cdot 24 \text{ V} + 0.4 \mu\text{J} \cdot 20 \text{ kHz} = 128 \text{ mW}$$

$$< 250 \text{ mW} (P_{O(MAX)} @ 85^\circ\text{C})$$

The value of 3 mA for I<sub>CC</sub> in the previous equation is the max. I<sub>CC</sub> over entire operating temperature range.

Since P<sub>O</sub> for this case is less than P<sub>O(MAX)</sub>, R<sub>g</sub> = 32 Ω is alright for the power dissipation.



Figure 20. Energy dissipated in the HCPL-0314 and for each IGBT switching cycle.

### LED Drive Circuit Considerations for Ultra High CMR Performance

Without a detector shield, the dominant cause of optocoupler CMR failure is capacitive coupling from the input side of the optocoupler, through the package, to the detector IC as shown in Figure 21. The HCPL-3140/HCPL-0314 improves CMR performance by using a detector IC with an optically transparent Faraday shield, which diverts the capacitively coupled current away from the sensitive IC circuitry. However, this shield does not eliminate the capacitive coupling between the LED and opto-coupler pins 5-8 as shown in Figure 22. This capacitive coupling causes perturbations in the LED current during common mode transients and becomes the major source of CMR failures for a shielded optocoupler. The main design objective of a high CMR LED drive circuit becomes keeping the LED in the proper state (on or off) during common mode transients. For example, the recommended application circuit (Figure 19), can achieve 10 kV/μs CMR while minimizing component complexity.

Techniques to keep the LED in the proper state are discussed in the next two sections.



Figure 21. Optocoupler input to output capacitance model for unshielded optocouplers.



Figure 22. Optocoupler input to output capacitance model for shielded optocouplers.



Figure 23. Equivalent circuit for Figure 17 during common mode transient.



Figure 24. Not recommended open collector drive circuit.



Figure 25. Recommended LED drive circuit for ultra-high CMR IPM dead time and propagation delay specifications.

#### CMR with the LED On (CMR<sub>H</sub>)

A high CMR LED drive circuit must keep the LED on during common mode transients. This is achieved by overdriving the LED current beyond the input threshold so that it is not pulled below the threshold during a transient. A minimum LED current of 8 mA provides adequate margin over the maximum I<sub>FLH</sub> of 5 mA to achieve 10 kV/μs CMR.

#### CMR with the LED Off (CMR<sub>L</sub>)

A high CMR LED drive circuit must keep the LED off ( $V_F \leq V_{F(OFF)}$ ) during common mode transients. For example, during a -dV<sub>CM</sub>/dt transient in Figure 23, the current flowing through C<sub>LEDP</sub> also flows through the R<sub>SAT</sub> and V<sub>SAT</sub> of the logic gate. As long as the low state voltage developed across the logic gate is less than V<sub>F(OFF)</sub> the LED will remain off and no common mode failure will occur.

The open collector drive circuit, shown in Figure 24, can not keep the LED off during a +dV<sub>CM</sub>/dt transient, since all the current flowing through C<sub>LEDN</sub> must be

supplied by the LED, and it is not recommended for applications requiring ultra high CMR<sub>1</sub> performance. The alternative drive circuit which like the recommended application circuit (Figure 19), does achieve ultra high CMR performance by shunting the LED in the off state.

#### IPM Dead Time and Propagation Delay Specifications

The HCPL-3140/HCPL-0314 includes a Propagation Delay Difference (PDD) specification intended to help designers minimize “dead time” in their power inverter designs. Dead time is the time high and low side power transistors are off. Any overlap in Q1 and Q2 conduction will result in large currents flowing through the power devices from the high-voltage to the low-voltage motor rails. To minimize dead time in a given design, the turn on of LED2 should be delayed (relative to the turn off of LED1) so that under worst-case conditions, transistor Q1 has just turned off when transistor Q2 turns on, as shown in Figure 26. The amount of delay necessary to achieve this

condition is equal to the maximum value of the propagation delay difference specification, PDD max, which is specified to be 500 ns over the operating temperature range of -40° to 100°C.

Delaying the LED signal by the maximum propagation delay difference ensures that the minimum dead time is zero, but it does not tell a designer what the maximum dead time will be. The maximum dead time is equivalent to the difference between the maximum and minimum propagation delay difference specification as shown in Figure 27. The maximum dead time for the HCPL-3140/HCPL-0314 is 1 μs (= 0.5 μs - (-0.5 μs)) over the operating temperature range of -40°C to 100°C.

Note that the propagation delays used to calculate PDD and dead time are taken at equal temperatures and test conditions since the optocouplers under consideration are typically mounted in close proximity to each other and are switching identical IGBTs.

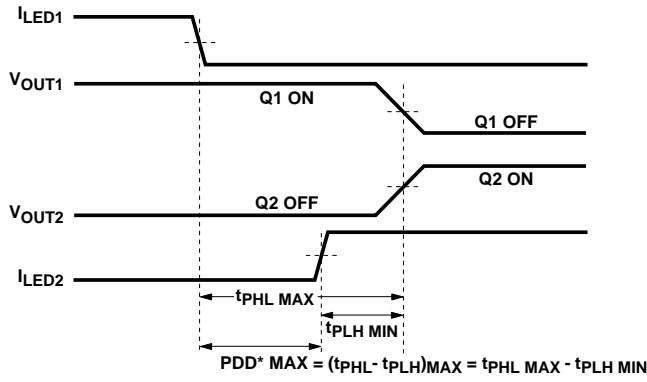

\*PDD = PROPAGATION DELAY DIFFERENCE  
 NOTE: FOR PDD CALCULATIONS THE PROPAGATION DELAYS ARE TAKEN AT THE SAME TEMPERATURE AND TEST CONDITIONS.

Figure 26. Minimum LED skew for zero dead time.



\*PDD = PROPAGATION DELAY DIFFERENCE  
 NOTE: FOR DEAD TIME AND PDD CALCULATIONS ALL PROPAGATION DELAYS ARE TAKEN AT THE SAME TEMPERATURE AND TEST CONDITIONS.

Figure 27. Waveforms for dead time.

For product information and a complete list of distributors, please go to our website: [www.avagotech.com](http://www.avagotech.com)

Avago, Avago Technologies, and the A logo are trademarks of Avago Technologies Limited in the United States and other countries.  
Data subject to change. Copyright © 2007 Avago Technologies Limited. All rights reserved. Obsoletes AV01-0366EN  
AV02-0162EN April 26, 2007





Компания «Life Electronics» занимается поставками электронных компонентов импортного и отечественного производства от производителей и со складов крупных дистрибьюторов Европы, Америки и Азии.

С конца 2013 года компания активно расширяет линейку поставок компонентов по направлению коаксиальный кабель, кварцевые генераторы и конденсаторы (керамические, пленочные, электролитические), за счёт заключения дистрибьюторских договоров

Мы предлагаем:

- Конкурентоспособные цены и скидки постоянным клиентам.
- Специальные условия для постоянных клиентов.
- Подбор аналогов.
- Поставку компонентов в любых объемах, удовлетворяющих вашим потребностям.
- Приемлемые сроки поставки, возможна ускоренная поставка.
- Доставку товара в любую точку России и стран СНГ.
- Комплексную поставку.
- Работу по проектам и поставку образцов.
- Формирование склада под заказчика.
- Сертификаты соответствия на поставляемую продукцию (по желанию клиента).
- Тестирование поставляемой продукции.
- Поставку компонентов, требующих военную и космическую приемку.
- Входной контроль качества.
- Наличие сертификата ISO.

В составе нашей компании организован Конструкторский отдел, призванный помогать разработчикам, и инженерам.

Конструкторский отдел помогает осуществить:

- Регистрацию проекта у производителя компонентов.
- Техническую поддержку проекта.
- Защиту от снятия компонента с производства.
- Оценку стоимости проекта по компонентам.
- Изготовление тестовой платы монтаж и пусконаладочные работы.



Тел: +7 (812) 336 43 04 (многоканальный)

Email: [org@lifeelectronics.ru](mailto:org@lifeelectronics.ru)