



BBS3002

P-Channel Power MOSFET -60V, -100A, 5.8mΩ, TO-263-2L/TO-263

ON Semiconductor®

<http://onsemi.com>

TO-263

Features

- ON-resistance $R_{DS(on)1}=4.4\text{m}\Omega$ (typ.)
- Input capacitance $C_{iss}=13200\text{pF}$ (typ.)
- 4V drive

Specifications

Absolute Maximum Ratings at $T_a=25^\circ\text{C}$

Parameter	Symbol	Conditions	Ratings	Unit
Drain to Source Voltage	V_{DSS}		-60	V
Gate to Source Voltage	V_{GSS}		± 20	V
Drain Current (DC)	I_D		-100	A
Drain Current (Pulse)	I_{DP}	$PW \leq 10\mu\text{s}$, duty cycle $\leq 1\%$	-400	A
Allowable Power Dissipation	P_D	$T_c=25^\circ\text{C}$	90	W
Channel Temperature	T_{ch}		150	$^\circ\text{C}$
Storage Temperature	T_{stg}		-55 to +150	$^\circ\text{C}$
Avalanche Energy (Single Pulse) *1	E_{AS}		340	mJ
Avalanche Current *2	I_{AV}		-60	A

Note : *1 $V_{DD}=-30\text{V}$, $L=100\mu\text{H}$, $I_{AV}=-60\text{A}$ (Fig.1)*2 $L \leq 100\mu\text{H}$, Single pulse

Stresses exceeding Maximum Ratings may damage the device. Maximum Ratings are stress ratings only. Functional operation above the Recommended Operating Conditions is not implied. Extended exposure to stresses above the Recommended Operating Conditions may affect device reliability.

Electrical Characteristics at $T_a=25^\circ\text{C}$

Parameter	Symbol	Conditions	Ratings			Unit
			min	typ	max	
Drain to Source Breakdown Voltage	$V_{(BR)DSS}$	$I_D=-1\text{mA}$, $V_{GS}=0\text{V}$	-60			V
Zero-Gate Voltage Drain Current	I_{DSS}	$V_{DS}=-60\text{V}$, $V_{GS}=0\text{V}$			-1	μA
Gate to Source Leakage Current	I_{GSS}	$V_{GS}=\pm 16\text{V}$, $V_{DS}=0\text{V}$			± 10	μA
Cutoff Voltage	$V_{GS(off)}$	$V_{DS}=-10\text{V}$, $I_D=-1\text{mA}$	-1.2		-2.6	V
Forward Transfer Admittance	$ y_{fs} $	$V_{DS}=-10\text{V}$, $I_D=-50\text{A}$	54	90		S
Static Drain to Source On-State Resistance	$R_{DS(on)1}$	$I_D=-50\text{A}$, $V_{GS}=-10\text{V}$		4.4	5.8	$\text{m}\Omega$
	$R_{DS(on)2}$	$I_D=-50\text{A}$, $V_{GS}=-4\text{V}$		6.4	9.0	$\text{m}\Omega$
Input Capacitance	C_{iss}			13200		pF
Output Capacitance	C_{oss}	$V_{DS}=-20\text{V}$, $f=1\text{MHz}$		1300		pF
Reverse Transfer Capacitance	C_{rss}			950		pF
Turn-ON Delay Time	$t_d(on)$	See Fig.2		95		ns
Rise Time	t_r			1000		ns
Turn-OFF Delay Time	$t_d(off)$			800		ns
Fall Time	t_f			820		ns
Total Gate Charge	Q_g				280	
Gate to Source Charge	Q_{gs}	$V_{DS}=-30\text{V}$, $V_{GS}=-10\text{V}$, $I_D=-100\text{A}$		50		nC
Gate to Drain "Miller" Charge	Q_{gd}			55		nC
Diode Forward Voltage	V_{SD}	$I_S=-100\text{A}$, $V_{GS}=0\text{V}$	-1.0		-1.5	V

ORDERING INFORMATION

See detailed ordering and shipping information on page 6 of this data sheet.

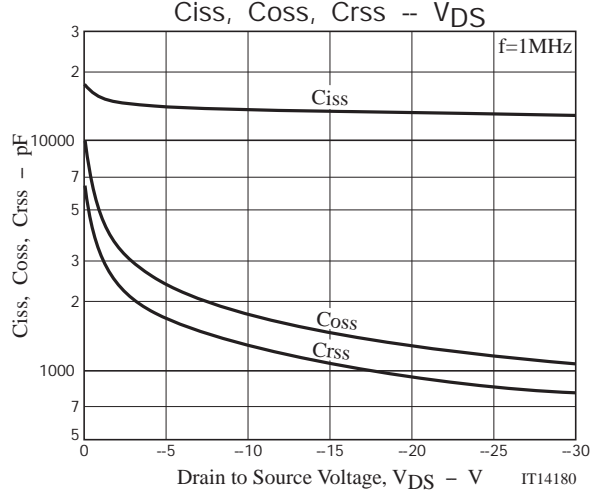
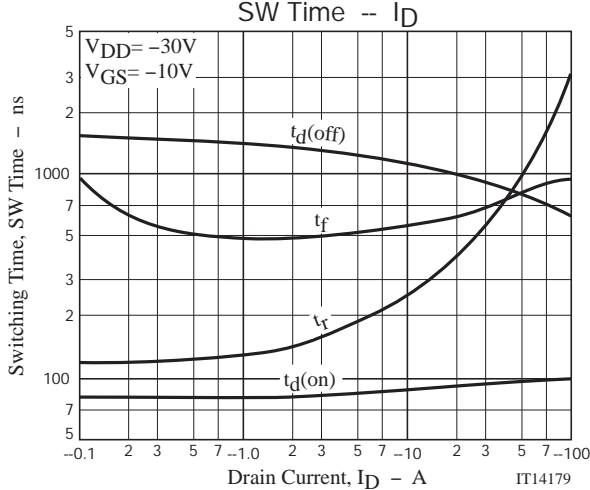
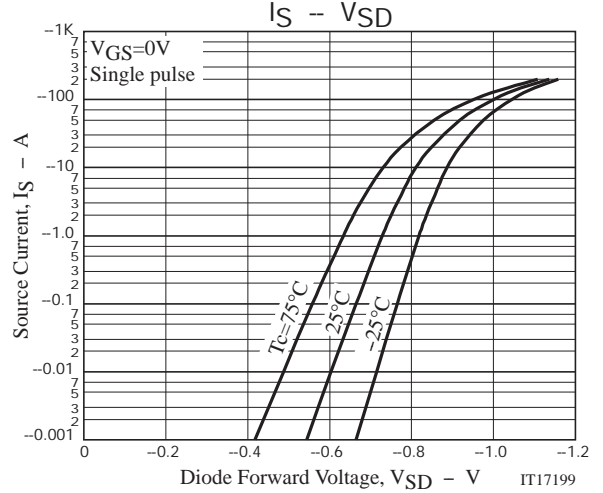
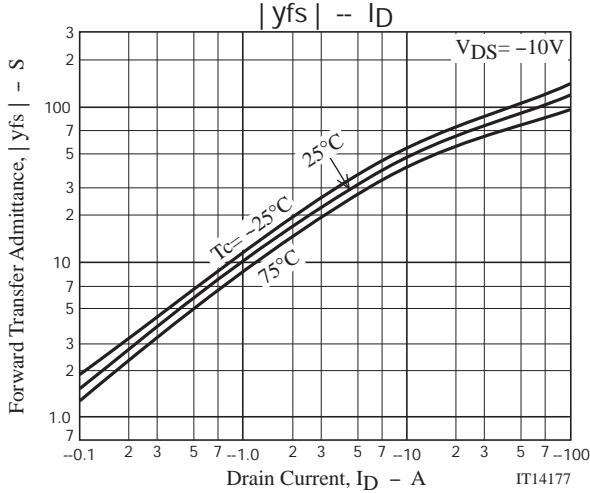
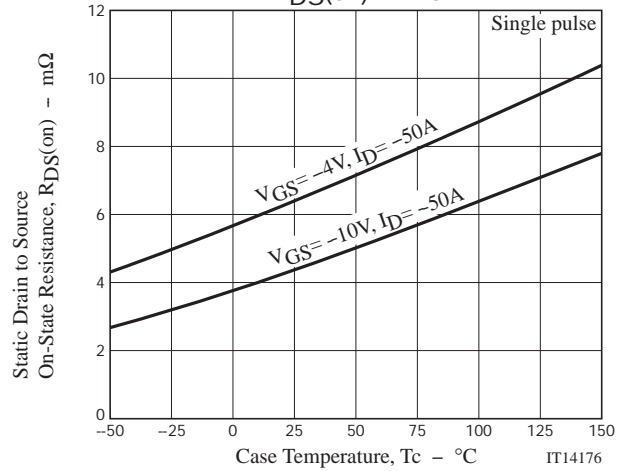
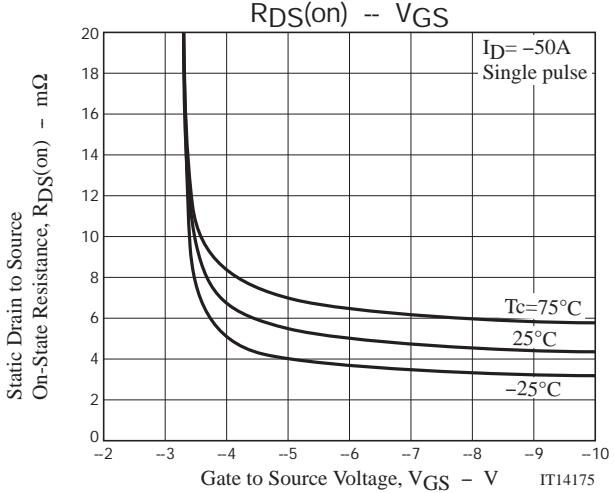
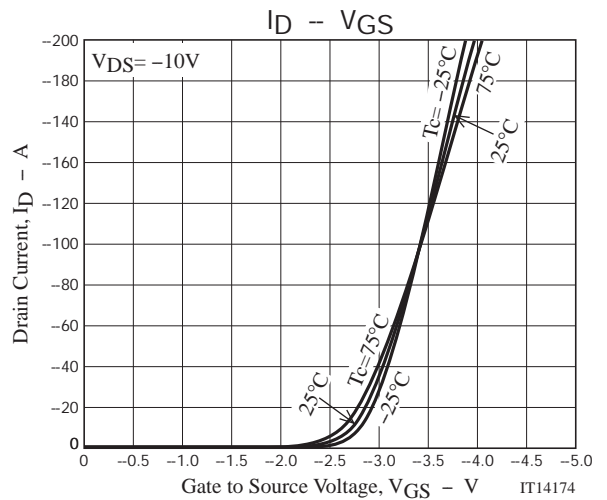
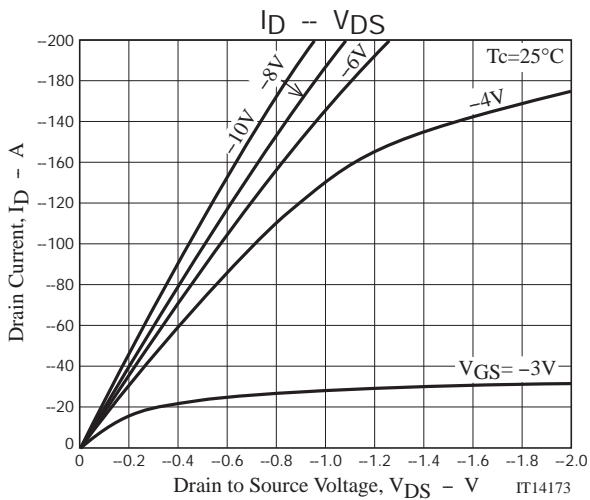

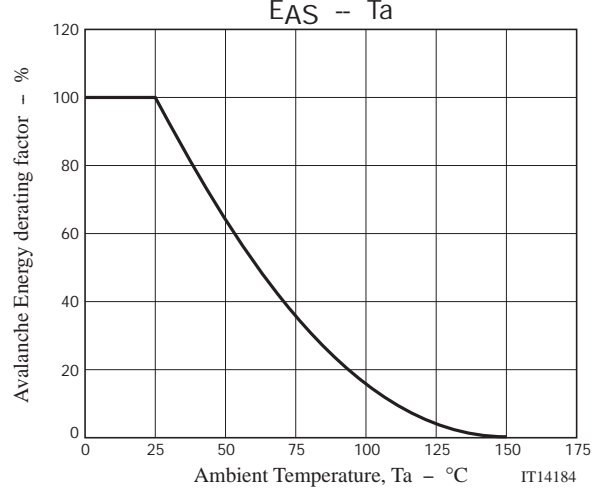
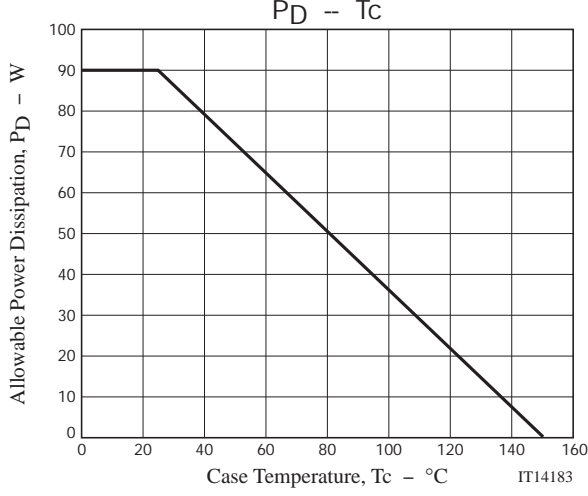
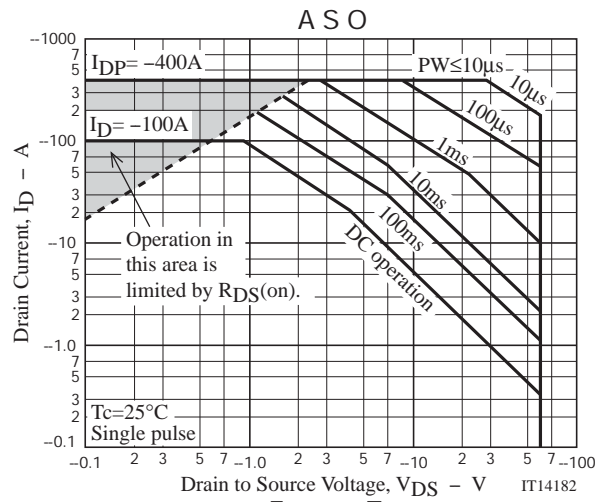
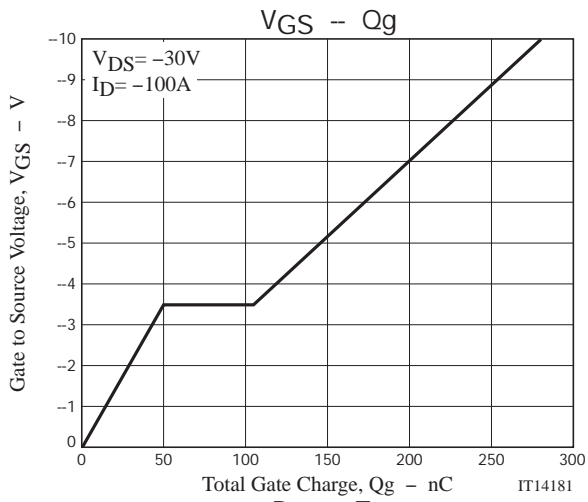

Package Dimensions

BBS3002-DL-1E

D2PAK/TO-263-2L

CASE 418AP

ISSUE O

Unit : mm

- 1: Gate
- 2: Drain
- 3: Source
- 4: Drain

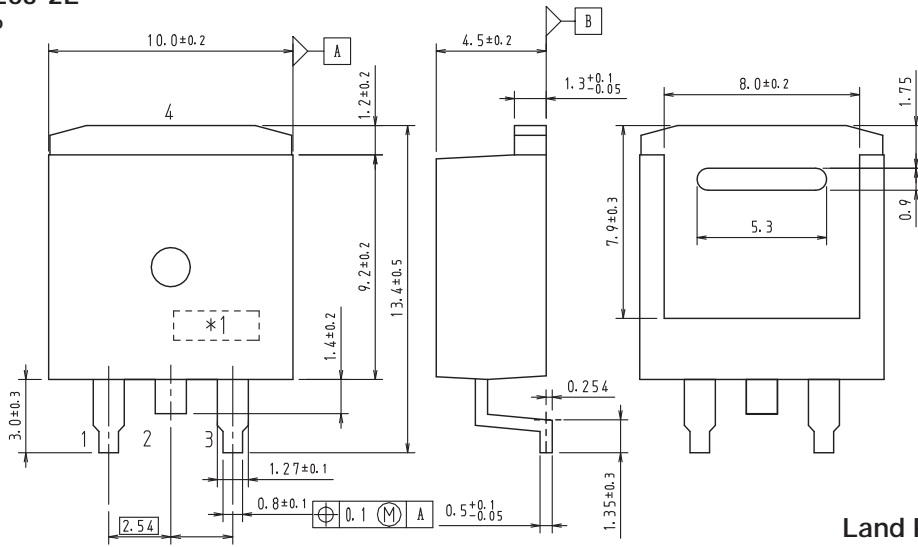

Land Pattern Example

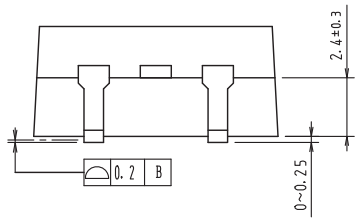

- 1. These dimension do not include mold protrusion
- 2. Pin2 is idle pin with electrical designation only carried

*1: Lot indication

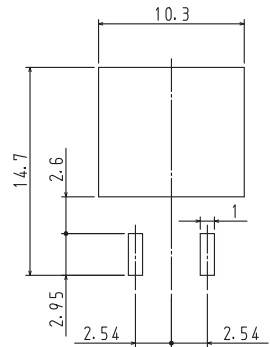

Packing Type: DL

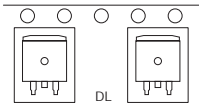

Electrical Connection

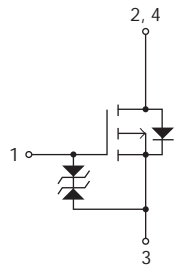

Package Dimensions

BBS3002-TL-1E

Unit : mm

- 1: Gate
- 2: Drain
- 3: Source
- 4: Drain

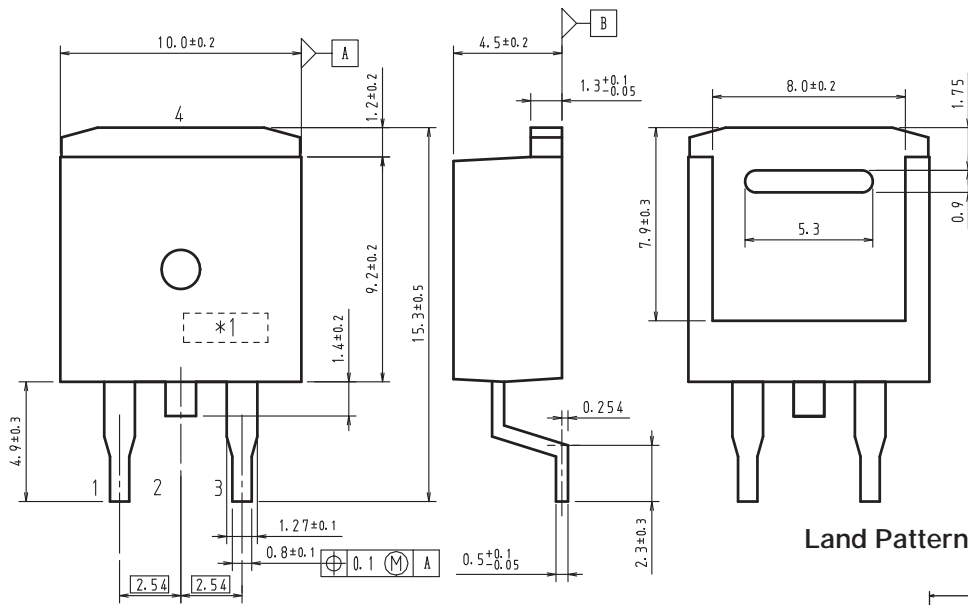

Land Pattern Example

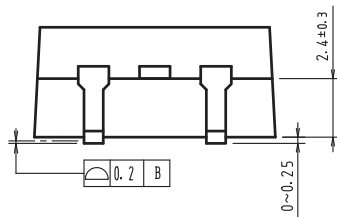

1. These dimension do not include mold protrusion
2. Pin2 is idle pin with electrical designation only carried

*1: Lot indication

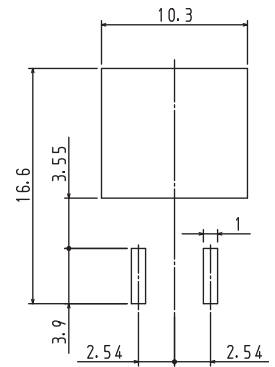

Packing Type: TL

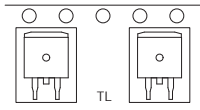

Electrical Connection

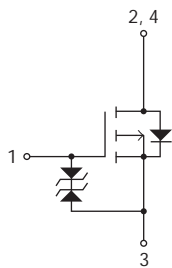

Ordering & Package Information

Device	Package	Shipping	memo
BBS3002-DL-1E	TO-263-2L SC-83, TO-263	800 pcs./reel	Pb-Free
BBS3002-TL-1E	TO-263		

Marking

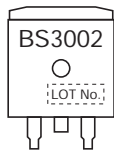

Fig.1 Unclamped Inductive Switching Test Circuit

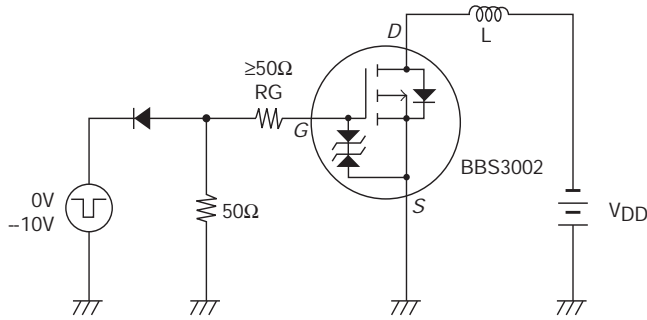
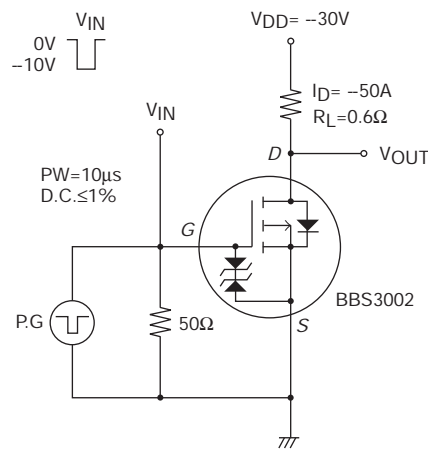

Fig.2 Switching Time Test Circuit



Note on usage : Since the BBS3002 is a MOSFET product, please avoid using this device in the vicinity of highly charged objects.

ON Semiconductor and the ON logo are registered trademarks of Semiconductor Components Industries, LLC (SCILLC). SCILLC owns the rights to a number of patents, trademarks, copyrights, trade secrets, and other intellectual property. A listing of SCILLC's product/patent coverage may be accessed at www.onsemi.com/site/pdf/Patent-Marking.pdf. SCILLC reserves the right to make changes without further notice to any products herein. SCILLC makes no warranty, representation or guarantee regarding the suitability of its products for any particular purpose, nor does SCILLC assume any liability arising out of the application or use of any product or circuit, and specifically disclaims any and all liability, including without limitation special, consequential or incidental damages. "Typical" parameters which may be provided in SCILLC data sheets and/or specifications can and do vary in different applications and actual performance may vary over time. All operating parameters, including "Typicals" must be validated for each customer application by customer's technical experts. SCILLC does not convey any license under its patent rights nor the rights of others. SCILLC products are not designed, intended, or authorized for use as components in systems intended for surgical implant into the body, or other applications intended to support or sustain life, or for any other application in which the failure of the SCILLC product could create a situation where personal injury or death may occur. Should Buyer purchase or use SCILLC products for any such unintended or unauthorized application, Buyer shall indemnify and hold SCILLC and its officers, employees, subsidiaries, affiliates, and distributors harmless against all claims, costs, damages, and expenses, and reasonable attorney fees arising out of, directly or indirectly, any claim of personal injury or death associated with such unintended or unauthorized use, even if such claim alleges that SCILLC was negligent regarding the design or manufacture of the part. SCILLC is an Equal Opportunity/Affirmative Action Employer. This literature is subject to all applicable copyright laws and is not for resale in any manner.

Компания «Life Electronics» занимается поставками электронных компонентов импортного и отечественного производства от производителей и со складов крупных дистрибьюторов Европы, Америки и Азии.

С конца 2013 года компания активно расширяет линейку поставок компонентов по направлению коаксиальный кабель, кварцевые генераторы и конденсаторы (керамические, пленочные, электролитические), за счёт заключения дистрибьюторских договоров

Мы предлагаем:

- Конкурентоспособные цены и скидки постоянным клиентам.
- Специальные условия для постоянных клиентов.
- Подбор аналогов.
- Поставку компонентов в любых объемах, удовлетворяющих вашим потребностям.
- Приемлемые сроки поставки, возможна ускоренная поставка.
- Доставку товара в любую точку России и стран СНГ.
- Комплексную поставку.
- Работу по проектам и поставку образцов.
- Формирование склада под заказчика.
- Сертификаты соответствия на поставляемую продукцию (по желанию клиента).
- Тестирование поставляемой продукции.
- Поставку компонентов, требующих военную и космическую приемку.
- Входной контроль качества.
- Наличие сертификата ISO.

В составе нашей компании организован Конструкторский отдел, призванный помогать разработчикам, и инженерам.

Конструкторский отдел помогает осуществить:

- Регистрацию проекта у производителя компонентов.
- Техническую поддержку проекта.
- Защиту от снятия компонента с производства.
- Оценку стоимости проекта по компонентам.
- Изготовление тестовой платы монтаж и пусконаладочные работы.

