

0805 Multilayer Ferrite Chip Bead

ACML-0805



RoHS/RoHS II compliant



2.00 x 1.25 x 0.85mm

FEATURES:

- Multilayer monolithic construction yields high reliability
- Nickel barrier terminations provide excellent solder heat resistance
- Suitable for flow and RoHS reflow soldering

APPLICATIONS:

- Video equipment, audio equipment
- Automotive electrical equipment
- Communication equipment
- OA equipment and other

ELECTRICAL SPECIFICATIONS:

PARAMETERS

Operating temperature: -55°C to + 125°C

Storage temperature : -55°C to + 125°C

| Part Number | Impedance | Frequency | DC resistance | Rated Current |
|---------------|-------------------|-----------|-----------------|----------------|
| Units | $\Omega \pm 25\%$ | MHz | Ω max | mA max |
| Symbol | Z | F | R _{DC} | I _R |
| ACML-0805-070 | 7 | 100 | 0.05 | 2200 |
| ACML-0805-110 | 11 | 100 | 0.05 | 2000 |
| ACML-0805-170 | 17 | 100 | 0.05 | 2000 |
| ACML-0805-190 | 19 | 100 | 0.05 | 2000 |
| ACML-0805-260 | 26 | 100 | 0.05 | 1500 |
| ACML-0805-310 | 31 | 100 | 0.05 | 1500 |
| ACML-0805-360 | 36 | 100 | 0.05 | 1500 |
| ACML-0805-500 | 50 | 100 | 0.05 | 1000 |
| ACML-0805-600 | 60 | 100 | 0.05 | 1000 |
| ACML-0805-700 | 70 | 100 | 0.08 | 1000 |
| ACML-0805-800 | 80 | 100 | 0.10 | 1000 |
| ACML-0805-101 | 100 | 100 | 0.12 | 1000 |
| ACML-0805-121 | 120 | 100 | 0.15 | 800 |
| ACML-0805-151 | 150 | 100 | 0.15 | 800 |
| ACML-0805-181 | 180 | 100 | 0.20 | 600 |
| ACML-0805-221 | 220 | 100 | 0.20 | 600 |
| ACML-0805-301 | 300 | 100 | 0.25 | 500 |
| ACML-0805-501 | 500 | 100 | 0.30 | 500 |
| ACML-0805-601 | 600 | 100 | 0.35 | 500 |
| ACML-0805-751 | 750 | 100 | 0.35 | 300 |
| ACML-0805-102 | 1000 | 100 | 0.45 | 300 |
| ACML-0805-122 | 1200 | 50 | 0.50 | 200 |
| ACML-0805-152 | 1500 | 50 | 0.65 | 200 |
| ACML-0805-202 | 2000 | 50 | 0.80 | 200 |

Test Conditions and Equipments

I_R: Rated current applied when the chip surface temperature rise just 20°C against chip surface temperature.

Electric power supplier, Electric current meter, Thermometer.

Z: Impedance Analyzer HP4291 or equivalent, 50mV.

DCR: LCR Meter HP4263A or equivalent



0805 Multilayer Ferrite Chip Bead

ACML-0805



RoHS/RoHS II compliant



2.00 x 1.25 x 0.85mm

OPTIONS AND PART IDENTIFICATION

ACML-0805 - -

Impedance Code

Please refer to the P/N table

Packaging

T: Tape and Reel
(4kpcs / reel)

FREQUENCY CHARACTERISTICS

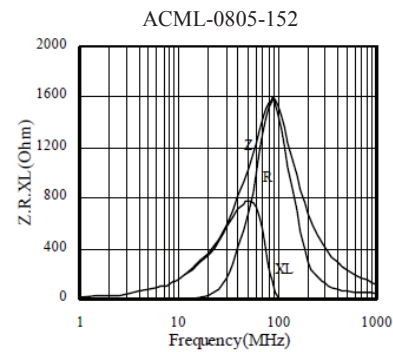
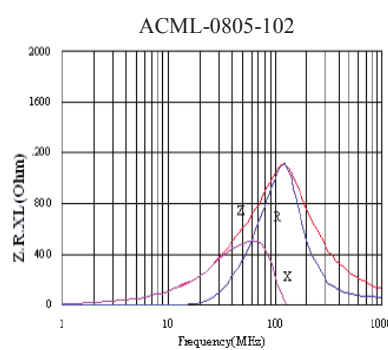
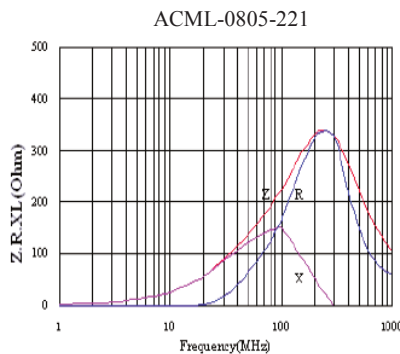
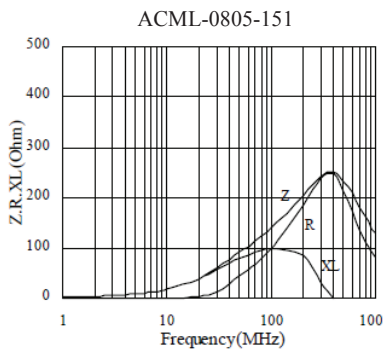
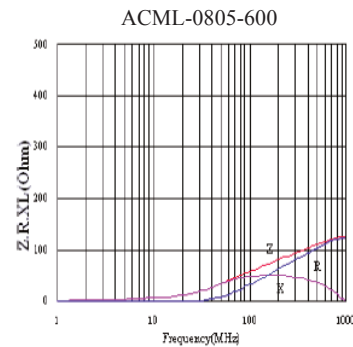
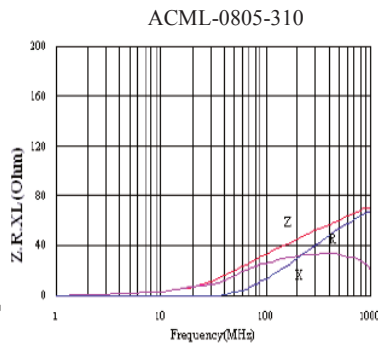
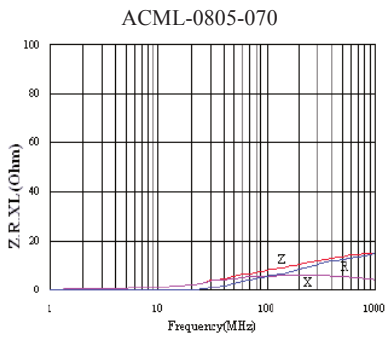

ABRACON IS
ISO9001:2008
CERTIFIED



ABRACON
CORPORATION

Visit www.abracon.com for Terms & Conditions of Sale **Revised: 04.09.14**
30332 Esperanza, Rancho Santa Margarita, California 92688
tel 949-546-8000 | fax 949-546-8001 | www.abracon.com

0805 Multilayer Ferrite Chip Bead

ACML-0805



RoHS/RoHS II compliant



2.00 x 1.25 x 0.85mm

MECHANICAL DIMENSIONS

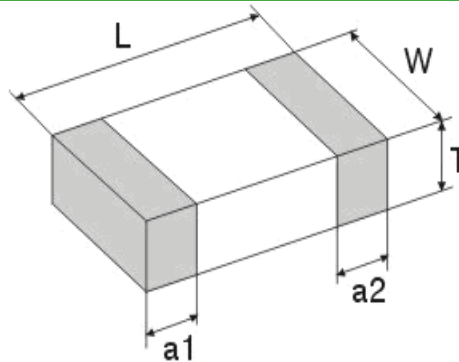

| L | W | T | a1, a2 |
|-----------|-----------|-----------|-----------|
| 2.00±0.20 | 1.25±0.20 | 0.85±0.20 | 0.50±0.30 |

Materials

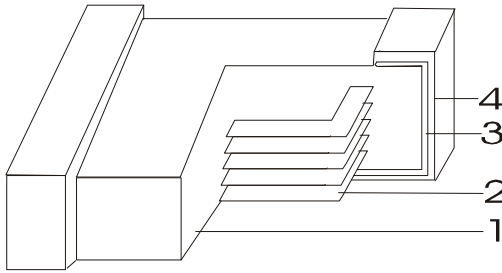

| | Part Name | Material |
|---|--------------------|----------|
| 1 | Base Material | Ferrite |
| 2 | Internal Conductor | Ag |
| 3 | Terminal Electrode | Ag |
| 4 | Terminal Electrode | Ni-Sn |

Dimension: mm

REFLOW PROFILE

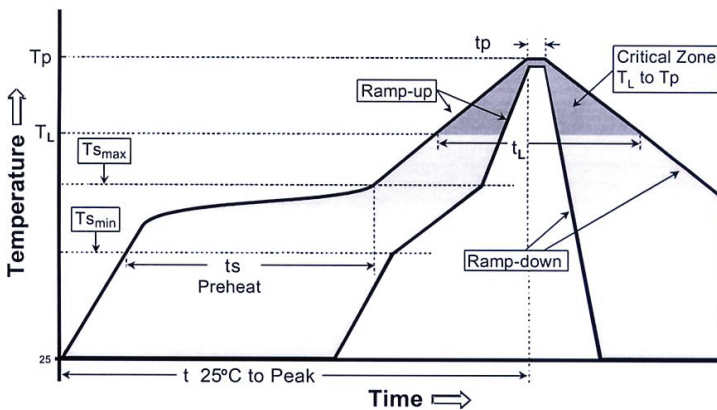

| Profile Feature | Lead-Free Assembly |
|-------------------------------------------------------------------------------------------------------------------------------------------------|------------------------------------|
| Average Ramp-Up Rate (T _{smax} to T _p) | 3°C/second max. |
| Preheat – Temperature Min (T _{smin}) – Temperature Max (T _{smax}) – Time (t _{smin} to t _{smax}) | 150 °C 200 °C 60-180 seconds |
| Time maintained above: – Temperature (T _L) – Time (t _L) | 217 °C 60-150 seconds |
| Peak/Classification Temperature (T _p) Peak/Classification Time (t _p) | 260 °C 3-4 seconds |
| Time within 5 °C of actual Peak Temperature (t _p) | 20-40 seconds |
| Ramp-Down Rate | 6°C/second max. |
| Time 25 °C to Peak Temperature | 8 minutes max. |

ABRACON IS
ISO9001:2008
CERTIFIED



Visit www.abracon.com for Terms & Conditions of Sale **Revised: 04.09.14**
30332 Esperanza, Rancho Santa Margarita, California 92688
tel 949-546-8000 | fax 949-546-8001 | www.abracon.com

0805 Multilayer Ferrite Chip Bead

ACML-0805



RoHS/RoHS II compliant



2.00 x 1.25 x 0.85mm

TAPE & REEL:

T= tape and reel (4,000 pcs per reel)



| | |
|--------|------------|
| A | 1.5±0.15 |
| B | 2.5±0.2 |
| C | 8.0±0.3 |
| D | 3.5±0.05 |
| E | 1.75±0.1 |
| F | 4.0±0.1 |
| G | 2.0±0.05 |
| H | 4.0±0.1 |
| ΦJ | 1.5+0.1/-0 |
| t(max) | 1.1±0.05 |



| | |
|---|-----------|
| A | 178±2 |
| B | 60±2 |
| C | 13.0±0.5 |
| D | 21.0±0.8 |
| E | 2.0±0.5 |
| W | 10.0±1.15 |
| t | 1.2±0.2 |
| R | 1.0±0.25 |

Dimension: mm

ATTENTION: Abracon Corporation's products are COTS – Commercial-Off-The-Shelf products; suitable for Commercial, Industrial and, where designated, Automotive Applications. Abracon's products are not specifically designed for Military, Aviation, Aerospace, Life-dependant Medical applications or any application requiring high reliability where component failure could result in loss of life and/or property. For applications requiring high reliability and/or presenting an extreme operating environment, written consent and authorization from Abracon Corporation is required. Please contact Abracon Corporation for more information.

ABRACON IS
ISO9001:2008
CERTIFIED



Visit www.abracon.com for Terms & Conditions of Sale **Revised: 04.09.14**
30332 Esperanza, Rancho Santa Margarita, California 92688
tel 949-546-8000 | fax 949-546-8001 | www.abracon.com

Компания «Life Electronics» занимается поставками электронных компонентов импортного и отечественного производства от производителей и со складов крупных дистрибьюторов Европы, Америки и Азии.

С конца 2013 года компания активно расширяет линейку поставок компонентов по направлению коаксиальный кабель, кварцевые генераторы и конденсаторы (керамические, пленочные, электролитические), за счёт заключения дистрибьюторских договоров

Мы предлагаем:

- Конкурентоспособные цены и скидки постоянным клиентам.
- Специальные условия для постоянных клиентов.
- Подбор аналогов.
- Поставку компонентов в любых объемах, удовлетворяющих вашим потребностям.
- Приемлемые сроки поставки, возможна ускоренная поставка.
- Доставку товара в любую точку России и стран СНГ.
- Комплексную поставку.
- Работу по проектам и поставку образцов.
- Формирование склада под заказчика.
- Сертификаты соответствия на поставляемую продукцию (по желанию клиента).
- Тестирование поставляемой продукции.
- Поставку компонентов, требующих военную и космическую приемку.
- Входной контроль качества.
- Наличие сертификата ISO.

В составе нашей компании организован Конструкторский отдел, призванный помогать разработчикам, и инженерам.

Конструкторский отдел помогает осуществить:

- Регистрацию проекта у производителя компонентов.
- Техническую поддержку проекта.
- Защиту от снятия компонента с производства.
- Оценку стоимости проекта по компонентам.
- Изготовление тестовой платы монтаж и пусконаладочные работы.



Тел: +7 (812) 336 43 04 (многоканальный)

Email: org@lifeelectronics.ru