

Right-Angle Posted Connectors

Right-Angle Posted Connectors



Connector Density	Type	Style and Shell Finish	No. of Contact Positions	Footprint	Mating Hardware	Board Mounting	Contact Plating (Mating Area/Solder Tails)	Post Length
HD-22	Plug and Receptacle	Front Metal-Shell, Tin Plated (Pg. 52)	15	.350 [8.89]	Threaded Inserts	Boardlocks	Duplex (0.000030 [0.00076] Gold/Tin)	.125 [3.18]
			26		Female Screwlocks		Duplex (Gold Flash/Tin)	
			44		Standard Screws		Duplex (.000030 [0.00076] Gold/Tin)	
			62		Female Screwlocks		Duplex (Gold Flash/Tin)	
HD-20	Plugs and Receptacles	Full Metal-Shell With and Without Grounding Indents, Tin Plated (Pgs. 71, 139, 155)	9	.454 [11.53]	Standard Screws	Dia. Holes	Duplex (.000030 [0.00076] Gold/Tin)	.125 [3.18]
			15		Female Screwlocks		Duplex (Gold Flash/Tin)	
			25		Female Screwlocks		Duplex (Gold Flash/Tin)	
			37		Female Screwlocks		Duplex (Gold Flash/Tin)	
			50		Female Screwlocks		Duplex (Gold Flash/Tin)	
		Front Metal-Shell With Grounding Indents, Tin Plated (Pgs. 55-58, 60-63, 65-67, 131, 134, 138, 143, 150)	9	.318 [8.08]	.120 [3.05] Dia. Holes	Boardlocks	Duplex (.000030 [0.00076] Gold/Tin)	.125 [3.18]
			15		Threaded Inserts		Duplex (Gold Flash/Tin)	
			25		Threaded Inserts		Duplex (Gold Flash/Tin)	
			37		Female Screwlocks		Duplex (Gold Flash/Tin)	
			37		Female Screwlocks		Duplex (Gold Flash/Tin)	
All-Plastic (Pgs. 68-70, 132, 133, 135, 136)	9	.318 [8.08]	.120 [3.05] Dia. Holes	Boardlocks	Duplex (.000030 [0.00076] Gold/Tin)	.125 [3.18]		
	15		Threaded Inserts		Duplex (Gold Flash/Tin)			
	25		Threaded Inserts		Duplex (Gold Flash/Tin)			
	37		Female Screwlocks		Duplex (Gold Flash/Tin)			

Right-Angle Posted Connectors (Continued)

Product Facts:

- Flame retardant thermoplastic housing material, UL 94V-0 rated
- HD-20 right-angle connectors are available in 9, 15, 25 and 37 positions (Shell Sizes 1 thru 4) in both plug and receptacle versions; some versions available in 50 position, (Shell Size 5)
- HD-20 stacked connectors are available in 9/9, 15/15, 25/25, and 37/37 positions (Shell Sizes 1 thru 4) in receptacle over receptacle, plug over plug and combination versions
- HD-22 right-angle receptacle connectors are available in 15, 26, 44, 62 and 78 positions (Shell Sizes 1 thru 5)
- Low cost front metal-shell design compatible with full metal-shell connectors
- Integral boardlock versions secure posted connectors to pc boards prior to soldering

- HD-20 and HD-22 connector contacts are available in plating types to satisfy different applications
- HD-22 right-angle posted connectors are designed for high temperature applications
- Integral fixed 4-40 threaded inserts and screwlocks are available in both HD-20 and HD-22 connectors
- Connectors are intermate-able with any size 20 or 22 subminiature D connectors dimensionally complying with MIL-C-24308

Section Contents

HD-22 and HD-20 Contact Arrangements 40
 HD-22 and HD-20 Performance Specifications 41
 Plug/Receptacle Mating and Panel Mounting Specifications 42
 AMPLIMITE HD-20 Subminiature D Stacked PCB Connectors
 Hybrid and Mixed Styles 43-48
 AMPLIMITE 2000 Subminiature D Connectors 49, 50
 HD-20 and HD-22 Slimline Connectors 51
 HD-22 Right-Angle Posted Subminiature D Connectors 52, 53
 HD-20 Front Metal-Shell Right-Angle Posted Connectors
 318 Mount 54-57
 HD-20 Full Metal-Shell Right-Angle Posted Connectors
 454 Mount 58, 59
 HD-20 Front Metal-Shell Right-Angle Posted Connectors
 478 Mount 60, 61
 HD-20 Full Metal-Shell Right-Angle Posted Connectors
 545 Mount 62, 63
 HD-20 Front Metal-Shell Right-Angle Posted Connectors
 590 Mount 64, 65
 HD-20 All-Plastic Right-Angle Posted Connectors
 318 Mount 66-68
 HD-20 All-Plastic Right-Angle Posted Connectors
 590 Mount 69-71
 Right-Angle Mounting Connectors—European Standard Footprint 72
 Right-Angle Mounting Connectors—Eurostyle Footprint 73
 Standard Density Press Fit Termination, Right-Angle Mounting 74
 Subminiature D Connectors for Cable Mounting 75

Right-Angle Stacked Connectors (Centerline-to-centerline height .750 [19.05])

Connector Density	Type	Style and Shell Finish	No. of Contact Positions	Footprint	Mating Hardware	Board Mounting	Contact Plating (Mating Area/Solder Tails)	Post Length
HD-20	Receptacle over Receptacle							
	Plug over Plug	Front Metal-Shell, Tin Plated (Pgs. 144-149, 151)	9/9 15/15 25/25 37/37 (Std.)	See Customer Drawings	Threaded Inserts	.120 [3.05] Dia. Holes	Duplex (.000030 [0.00076] Gold/Tin) (.000010 [0.00025] Gold/Tin)	.125 [3.18]
	Receptacle over Plug				Female Screwlocks	Boardlocks	Duplex (Gold Flash/Tin)	
	Plug over Receptacle							

HD-22 and HD-20 Commercial Connectors (AMPLIMITE)

Contact Arrangements

HD-22 Inserts



Shell Size 1
(15 Position)



Shell Size 2
(26 Position)



Shell Size 3
(44 Position)



Shell Size 4
(62 Position)



Shell Size 5
(78 Position)

HD-20 Inserts



Shell Size 1
(9 Position)



Shell Size 2
(15 Position)

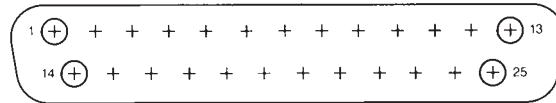

Shell Size 3
(25 Position)

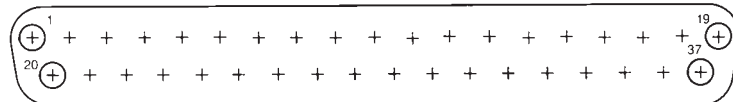

Shell Size 4
(37 Position)

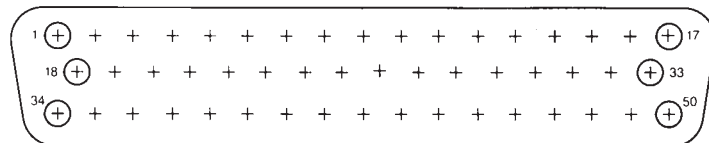

Shell Size 5
(50 Position)

Note: Mating face of plug is shown, receptacle is mirror-image.

HD-22 and HD-20 Connectors Performance Characteristics

Cable Connectors

	Connector Type		
	HDP-22	HDE-20	HDP-20
Electrical Characteristics			
Contact Current Rating (One pair of contacts)	22 AWG [0.4mm ²] Wire 5.0 amperes	20 AWG [0.6mm ²] 3 amperes	20 AWG [0.6mm ²] 7.5 amperes
Termination Resistance	15 milliohms (max.)	30 milliohms (max.)	15 milliohms (max.)
Dielectric Withstanding Voltage	1000 VAC min.	1000 VAC min.	1000 VAC min.
Insulation Resistance	5000 megohms min.	5000 megohms min.	5000 megohms min.
Mechanical Characteristics			
Contact Insertion Force	3 lb. max. [13.34 N max.]	N/A	3 lb. max. [13.34 N max.]
Contact Retention	5 lb. min. [22.24 N min.]	7 lb. min. [31.14 N min.]	10 lb. min. [44.48 N min.]
Contact Mating Force (Per contact circuit pair)	8 oz. max. [2.22 N max.]	8 oz. max. [2.22 N max.]	8 oz. max. [2.22 N max.]
Contact Unmating Force (Per contact circuit pair)	.75 oz. min. [0.209 N min.]	.75 oz. min. [0.209 N min.]	.75 oz. min. [0.209 N min.]
Tensile Strength	22 AWG—12 lb. [0.4mm ² —53.4 N] 24 AWG—8 lb. [0.2mm ² —35.6 N] 26 AWG—4.5 lb. [0.15mm ² —20.02 N] 28 AWG—2.7 lb. [0.08mm ² —12.01 N]	20 AWG—9.5 lb. [0.6mm ² —42.3 N] 22 AWG—6 lb. [0.4mm ² —26.7 N] 24 AWG—4 lb. [0.2mm ² —17.79 N] 26 AWG—2.5 lb. [0.15mm ² —11.12 N] 28 AWG—2.5 lb. [0.08mm ² —11.12 N] 30 AWG—1 lb. [0.05mm ² —4.45 N]	20 AWG—20 lb. [0.6mm ² —89 N] 22 AWG—12 lb. [0.4mm ² —53.4 N] 24 AWG—8 lb. [0.2mm ² —35.6 N] 26 AWG—4.5 lb. [0.15mm ² —20.02 N] 28 AWG—2.7 lb. [0.08mm ² —12.01 N]
Durability	.000030 [0.00076] gold—500 cycles Gold Flash— 100 cycles	.000030 [0.00076] gold—500 cycles Gold Flash— 100 cycles	.000030 [0.00076] gold—500 cycles Gold Flash— 100 cycles
Environmental Characteristics			
Vibration	Random 20 G's rms max.	Random 20 G's rms max.	Random 20 G's rms max.
Physical Shock	50 G's Duration 11 ms	50 G's Duration 11 ms	50 G's Duration 11 ms

Board Mount Connectors

	Connector Type
	HD-20
Electrical Characteristics	
Single Contact Current Rating (30°C Rise) Duration 11 ms	18 AWG 6.0 amperes 24 AWG 4.3 amperes 28 AWG 2.9 amperes
Termination Resistance	15 milliohms* (max.)
Dielectric Withstanding Voltage	1000 VAC min.**
Insulation Resistance	5000 megohms min.

*Stacked Connectors—30 milliohms (max.)
**Stacked Connectors—500 VAC min.

	Connector Type		
	HD-20		
Mechanical Characteristics			
Durability	.000030 [0.00076] gold—500 cycles Gold Flash—100 cycles		
Connector Mating and Unmating Force (lbs. max. over [N max.])	Size	HD-20 Without Grounding Indents	HD-20 With Grounding Indents
	1	4.5 [20.02]	30.0 [133.5]
	2	7.5 [33.4]	33.0 [146.8]
	3	12.5 [55.6]	37.0 [164.6]
	4	18.5 [82.3]	40.0 [177.9]
5	25.0 [111.2]	44.0 [195.7]	

Plug/Receptacle Mating and Panel Mounting Specifications

Plug/Receptacle Mating



The .265 [6.73] dimension is required to assure full mating of connector halves. This dimension must be taken into consideration when determining the method of mounting, panel thickness, etc.

Panel Mounting



Cutout for Rear Mount and Short Latching Block

Note: Cutouts are for either plug or receptacle, front or rear panel mount.

Most plugs and receptacles can be mounted to a panel from either the front or rear, using a variety of accessory hardware. Posted receptacles are rear panel mounted only. Typical examples are shown below.

Shell Size (Pos.)	Mounting Method Front/Rear Panel	Dimensions								
		A	B	C	D	E	F	H*	J*	K
1 (9)	Front	.984	.492	.874	.437	.513	.257	—	—	.083
	Rear	.984	.492	.806	.403	.449	.225	.550	.750	.132
2 (15)	Front	1.312	.656	1.202	.601	.513	.257	—	—	.083
	Rear	1.312	.656	1.134	.567	.449	.225	.730	.750	.132
3 (25)	Front	1.852	.926	1.743	.872	.513	.257	—	—	.083
	Rear	1.852	.926	1.674	.837	.449	.225	1.275	.750	.132
4 (37)	Front	2.500	1.250	2.391	1.196	.513	.257	—	—	.083
	Rear	2.500	1.250	2.326	1.163	.449	.225	1.920	.750	.132
5 (50)	Front	2.406	1.203	2.297	1.149	.623	.312	—	—	.083
	Rear	2.406	1.203	2.218	1.109	.555	.278	1.753	.750	.132

*Panel cutout configuration with H and J dimensions provides clearance for mounting connectors with cable clamps.
 **This dimension is .190^{+0.002} [4.83^{+0.05}] when posted connectors with fixed female screwlocks are rear-panel mounted.



Typical Front-Panel Mounted Subminiature D Plug



Typical Rear-Panel Mounted Subminiature D Receptacle

AMPLIMITE HD-20 Subminiature D Stacked PCB Connectors Hybrid and Mixed Styles

Product Facts

- Stacked pcb connectors save board real estate
- Wide choice of configurations available
- Front Metal-Shells for EMI/RFI shielding
- Housings made of UL 94V-0 rated thermoplastic
- Plug connectors have built-in grounding indents
- Choice of 4-40 threaded insert or female screwlock mating hardware
- Hybrid styles provide maximum selectivity and permit mixing of signal speeds
- Packaged in plastic trays for ease of handling
- Recognized under the Component Program of the Underwriters Laboratories, Inc.  File No. 28476
- Certified by Canadian Standards Association, File No. LR 7189 

See customer drawings for pcb layouts.



AMPLIMITE HD-20 Subminiature D Stacked PCB Connectors are members of the complete line of AMPLIMITE Subminiature D Connector family which has been accepted by the electronic industry for their rugged design and ease of application.

Stacked connectors add the advantage of reducing overall board real estate normally consumed by individual pcb connectors. The versatility of the AMPLIMITE HD-20 line enables you to select the stacked connector best suited for your specific application.

AMPLIMITE HD-20 Stacked Connectors, Series II offer a high degree of performance and a reduced cost. The line consists of:

- Receptacle over Receptacle in 9/9, 15/15, 25/25 and 37/37 contact positions

- Plug over Plug in 9/9, 15/15, 25/25 and 37/37 contact positions
- Receptacle over Plug in 9/9, 15/15, 25/25 and 37/37 contact positions
- Plug over Receptacle in a total of 9/9, 15/15, 25/25 and 37/37 contact positions

Configurations are available with a choice of mounting hardware—4-40 threaded inserts and female screwlocks.

Hybrid and Mixed Styles

AMPLIMITE Hybrid and Mixed Stacked Connectors combine a variety of subminiature D connector configurations into a single connector. This permits mixing signal speeds with a substantial reduction in pc board real estate.

All AMPLIMITE Stacked and Mixed PCB Connectors fea-

ture front metal-shells for EMI/RFI shielding, with housings made of UL 94V-0 approved material. The series offers gold plating in 30µ", 10µ" and gold flash on the mating end and tin plating on the termination end, with the entire contact nickel underplated.

Due to the versatility of the AMPLIMITE Hybrid and Mixed lines of connectors any combination with an AMPLIMITE HD-20 Connector as the top connector, HD-22 High Density, and AMPLIMITE .050 Series as the bottom connector can be provided based on your application requirements. Contact TE for additional information.

AMPLIMITE HD-20 Subminiature D Stacked PCB Connectors Hybrid and Mixed Styles (Continued)

Material and Finish:

Housing—94V-0 rated thermoplastic, black

Shell—Steel, tin plated

Contacts:

Pins—Brass

Sockets—Phosphor bronze

Contact Plating:

A—Gold flash on mating end, tin on solder tails with overall nickel plating underneath

B—.000010 [0.00025] gold on mating end, tin on solder tails with overall nickel underplate

C—.000030 [0.00076] gold on mating end, tin on solder tails with overall nickel underplate

Boardlocks—Brass, tin plated

Female Screwlocks—Brass, nickel plated

Threaded Inserts—Brass, tin plated

Brackets—Zinc

Technical Documents:

Product Specification
108-57517

See customer drawings for printed circuit board layouts.

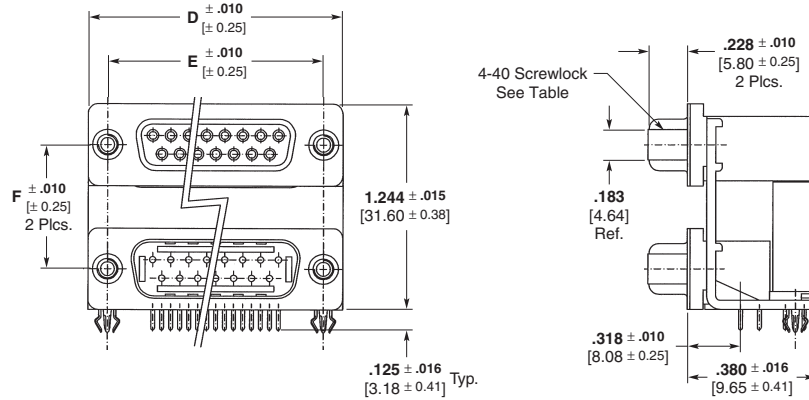

Upper D-Sub	Lower D-Sub	Dimensions			Contact Finish	Mounting Hardware	Part Number
		D	E	F			
9p Plug / 9p Plug	A	1.22	.984	.750	A	4-40 inserts	1734279-1
		30.95	24.99	19.05	B	4-40 inserts	1734279-2
		1.22	.984	.750	C	4-40 inserts	1734279-3
	C	1.22	.984	.750	A	4-40 fem s/l	1734280-1
		30.95	24.99	19.05	C	4-40 fem s/l	1734280-3
		1.22	.984	.750	A	4-40 inserts	1734282-1
	9p Plug / 9p Rcpt.	1.22	.984	.750	B	4-40 inserts	1734282-2
		30.95	24.99	19.05	C	4-40 inserts	1734282-3
		1.22	.984	.750	A	4-40 inserts	1734285-1
	9p Rcpt. / 9p Rcpt.	1.22	.984	.750	B	4-40 inserts	1734285-2
		30.95	24.99	19.05	C	4-40 inserts	1734285-3
		1.22	.984	.750	A	4-40 fem s/l	1734286-1
9p Rcpt. / 9p Plug	1.22	.984	.750	B	4-40 fem s/l	1734286-2	
	30.95	24.99	19.05	C	4-40 fem s/l	1734286-3	
	1.22	.984	.750	A	4-40 inserts	1734207-1	
15p Plug / 15p Plug	1.22	.984	.750	B	4-40 inserts	1734207-2	
	30.95	24.99	19.05	C	4-40 inserts	1734207-3	
	1.55	1.31	.750	A	4-40 inserts	1-1734279-1	
15p Plug / 15p Rcpt.	1.55	1.31	.750	B	4-40 inserts	1-1734279-2	
	39.30	33.30	19.05	C	4-40 inserts	1-1734279-3	
	1.55	1.31	.750	A	4-40 inserts	1-1734282-1	
15p Plug / 15p Rcpt.	1.55	1.31	.750	B	4-40 inserts	1-1734282-2	
	39.30	33.30	19.05	C	4-40 inserts	1-1734282-3	
	1.55	1.31	.750				

Continued on next page

Note: All part numbers are RoHS compliant.

AMPLIMITE HD-20 Subminiature D Stacked PCB Connectors Hybrid and Mixed Styles

Upper D-Sub	Lower D-Sub	Dimensions			Contact Finish	Mounting Hardware	Part Number
		D	E	F			
15p Rcpt.	/ 15p Rcpt.	1.55	1.31	.750	A	4-40 inserts	1-1734285-1
		39.30	33.30	19.05			
		1.55	1.31	.750	B	4-40 inserts	1-1734285-2
		39.30	33.30	19.05			
		1.55	1.31	.750	C	4-40 inserts	1-1734285-3
		39.30	33.30	19.05			
1.55	1.31	.750	A	4-40 fem s/l	1-1734286-1		
39.30	33.30	19.05					
15p Rcpt.	/ 15p Plug	1.55	1.31	.750	B	4-40 fem s/l	1-1734286-2
		39.30	33.30	19.05			
		1.55	1.31	.750	C	4-40 fem s/l	1-1734286-3
		39.30	33.30	19.05			
		1.55	1.31	.750	A	4-40 inserts	1-1734207-1
		39.30	33.30	19.05			
1.55	1.31	.750	B	4-40 inserts	1-1734207-2		
39.30	33.30	19.05					
25p Plug	/ 25p Plug	1.55	1.31	.750	C	4-40 inserts	1-1734207-3
		39.30	33.30	19.05			
		2.09	1.85	.750	A	4-40 inserts	2-1734279-1
		53.10	47.04	19.05			
		2.09	1.85	.750	B	4-40 inserts	2-1734279-2
		53.10	47.04	19.05			
2.09	1.85	.750	C	4-40 inserts	2-1734279-3		
53.10	47.04	19.05					
25p Plug	/ 25p Rcpt.	2.09	1.85	.750	A	4-40 inserts	2-1734282-1
		53.10	47.04	19.05			
		2.09	1.85	.750	B	4-40 inserts	2-1734282-2
		53.10	47.04	19.05			
		2.09	1.85	.750	C	4-40 inserts	2-1734282-3
		53.10	47.04	19.05			
2.09	1.85	.750	A	4-40 inserts	2-1734285-1		
53.10	47.04	19.05					
25p Rcpt.	/ 25p Rcpt.	2.09	1.85	.750	B	4-40 inserts	2-1734285-2
		53.10	47.04	19.05			
		2.09	1.85	.750	C	4-40 inserts	2-1734285-3
		53.10	47.04	19.05			
		2.09	1.85	.750	A	4-40 fem s/l	2-1734286-1
		53.10	47.04	19.05			
2.09	1.85	.750	B	4-40 fem s/l	2-1734286-2		
53.10	47.04	19.05					
25p Rcpt.	/ 25p Plug	2.09	1.85	.750	C	4-40 fem s/l	2-1734286-3
		53.10	47.04	19.05			
		2.09	1.85	.750	A	4-40 inserts	2-1734207-1
		53.10	47.04	19.05			
		2.09	1.85	.750	B	4-40 inserts	2-1734207-2
		53.10	47.04	19.05			
2.09	1.85	.750	C	4-40 inserts	2-1734207-3		
53.10	47.04	19.05					
37p Plug	/ 37p Plug	2.73	2.500	.750	A	4-40 inserts	3-1734279-1
		69.34	63.50	19.05			
		2.73	2.500	.750	B	4-40 inserts	3-1734279-2
		69.34	63.50	19.05			
		2.73	2.500	.750	C	4-40 inserts	3-1734279-3
		69.34	63.50	19.05			
2.73	2.500	.750	A	4-40 inserts	3-1734282-1		
69.34	63.50	19.05					
37p Plug	/ 37p Rcpt.	2.73	2.500	.750	B	4-40 inserts	3-1734282-2
		69.34	63.50	19.05			
		2.73	2.500	.750	C	4-40 inserts	3-1734282-3
		69.34	63.50	19.05			

Continued on next page

Note: All part numbers are RoHS compliant.

AMPLIMITE HD-20 Subminiature D Stacked PCB Connectors
Hybrid and Mixed Styles (Continued)

Upper D-Sub	Lower D-Sub	Dimensions			Contact Finish	Mounting Hardware	Part Number
		D	E	F			
37p Rcpt. / 37p Rcpt.		2.73 69.34	2.500 63.50	.750 19.05	A	4-40 inserts	3-1734285-1
		2.73 69.34	2.500 63.50	.750 19.05	B	4-40 inserts	3-1734285-2
		2.73 69.34	2.500 63.50	.750 19.05	C	4-40 inserts	3-1734285-3
		2.73 69.34	2.500 63.50	.750 19.05	A	4-40 fem s/l	3-1734286-1
		2.73 69.34	2.500 63.50	.750 19.05	B	4-40 fem s/l	3-1734286-2
		2.73 69.34	2.500 63.50	.750 19.05	C	4-40 fem s/l	3-1734286-3
37p Rcpt. / 37p Plug		2.73 69.34	2.500 63.50	.750 19.05	A	4-40 inserts	3-1734207-1
		2.73 69.34	2.500 63.50	.750 19.05	B	4-40 inserts	3-1734207-2
		2.73 69.34	2.500 63.50	.750 19.05	C	4-40 inserts	3-1734207-3

HD-20 Subminiature D Stacked PCB Connectors

Note: All part numbers are RoHS compliant.

AMPLIMITE HD-20 Subminiature D Stacked PCB Connectors Hybrid and Mixed Styles

HD-20 Front Metal Shell, Right-Angle AMPLIMITE Connectors

Material and Finish:

Housings and Pin Spacer—94V-0 rated thermoplastic, black

Contacts:

Sockets—Phosphor bronze or brass

Contact Plating—

Gold flash on mating end, tin on termination end, with entire contact nickel underplated

Shell—Steel, tin plated

Boardlocks—Copper alloy, plated tin

Bracket—Steel



9 Position HD-20 Receptacle over
15 Position HD-22 Receptacle
Part No. 1734870-1 (without Female Screwlocks)
Part No. 1-1734870-1 (as shown, with Female Screwlocks)

Note: All part numbers are RoHS compliant.

AMPLIMITE HD-20 Subminiature D Stacked PCB Connectors Hybrid and Mixed Styles (Continued)

HD-20 Front Metal Shell, Right-Angle Connectors

Material and Finish:

Housing—94V-0 rated PBT, see table

Contacts—Phosphor bronze or brass

HD22 Receptacle

Contact Plating—

Gold flash on contact area, tin on solder tail area, all over nickel underplated

Audio Jack—.000100 [.00254] min. tin over nickel underplate



15 Position HD-20 Receptacle over 3 Position Audio Plug

Description	Part Number	PC 99
With female screwlocks & color-coded audio ¹	1734287-2	—
With color-coded audio ¹	1-1734287-2	—
With color-coded audio ¹	—	1-1734287-3
With female screwlocks & back cover & color-coded audio ¹	—	2-1734287-3
With female screwlocks & color-coded audio ¹	—	3-1734287-3

¹ Color coded audio:
Audio line in — light blue
Audio line out — lime
Microphone — pink

HD-20 Subminiature D Stacked PCB Connectors

High-Rise Connectors

Material and Finish:

Housing—94V-0 rated thermoplastic, burgundy

Contacts—Phosphor bronze

Contact Plating:

A—.000010 [.000254] gold on mating area, tin on solder tails, all over nickel

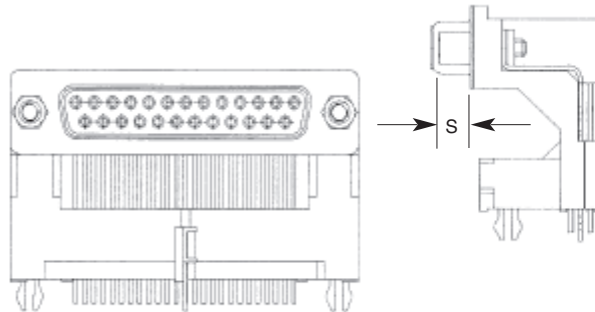

High-Rise 25 Position HD-20 Receptacle

Dimension S	Plating Code	Part Number	PC 99
.236 6.00	A	—	2-1734024-3

Note: All part numbers are RoHS compliant.

AMPLIMITE 2000 Subminiature D Connectors**Product Facts**

- Flame retardant housings, rated up to 105°C
- Front metal-shell design
- Duplex plated gold flash or .000015 [0.00038] min. gold on mating end, tin on solder end, all over nickel underplate
- With boardlocks and 4-40 threads or female screwlocks
- Designed to Office Class II
- 9, 15 & 25 right-angle plugs and receptacles
- Recognized under the Component Program of the Underwriters Laboratories, Inc.  File No. E28476

See customer drawings for circuit board layout.

**AMPLIMITE 2000**

Subminiature D connectors represent the latest breakthrough in economical Subminiature D connector design.

Presently available in the more popular sizes — 9-, 15- and 25-receptacles and plugs with a .318 [8.08] printed circuit board footprint, the AMPLIMITE 2000 connector line features front metal-shell RFI/EMI protection, flame retardant housings with integral 4-40 threads, boardlocks, and duplex plated gold-over-nickel contacts.

AMPLIMITE 2000 Subminiature Connectors (Continued)

HD-20 Front Metal Shell Right-Angle Connectors

Material and Finish:

Housing—94V-0 rated thermoplastic, black

Shell—Steel, nickel plated

Contacts:

Pins—Brass

Sockets—Phosphor bronze

Contact Plating:

A—Gold flash on mating end, tin on solder tails with overall nickel underplate

B—.000015 [0.00038] gold on mating end, tin on solder tails with overall nickel underplate

Boardlocks—Brass, tin or tin plated

Female Screwlocks—Brass, nickel plated

Threaded Inserts—Brass, nickel plated

Technical Documents:

Product Specification

108-57541



Typical Plug

Shell Size	Contact Finish	Dimension L Ref.	With Female Screwlocks	With 4-40 Threaded Inserts
9	A	1.210	1734351-1	1734352-1
	B	30.80	1734351-2	1734352-2
15	A	1.540	—	1734360-1
	B	39.20	—	1734360-2
25	A	2.090	Pending Obs.	Pending Obs.
	B	53.10	Pending Obs.	Pending Obs.



Typical Receptacle

Shell Size	Contact Finish	Dimension L Ref.	With Female Screwlocks	With 4-40 Threaded Inserts
9	A	1.210	1734354-1	1734348-1
	B	30.80	1734354-2	1734348-2
15	A	1.540	1734357-1	1734355-1
	B	39.20	1734357-2	1734355-2
25	A	2.090	1734349-1	1734350-1
	B	53.10	1734349-2	1734350-2

Note: All part numbers are RoHS compliant.

HD-20 and HD-22 Slimline Connectors

2 Rows of Solderetails

Material and Finish:

Housing—94V-0 rated thermoplastic, black

Shell—Low carbon steel, nickel plated

Contacts—Phosphor bronze or brass

Contact Plating—Gold flash on mating area; .000100 [0.00254] min. tin on solder tail area; overall .000050 [0.00127] min. nickel underplate

Boardlocks—Brass, tin plated over nickel underplate

Threaded Inserts—Brass, nickel plated

Technical Documents:

Product Specification
108-57541



9 Position Plug
Part Number 1734340-1



15 Position VESA Receptacle HD-22
Part Number 1734341-1

1 Row of Solderetails

Material and Finish:

Housing—94V-0 rated thermoplastic, black

Shell—Low carbon steel, nickel plated

Contacts—Brass

Contact Plating—.000015 [0.00038] min. gold on mating area; .000100 [0.00254] min. tin on solder tail area; overall .000050 [0.00127] min. nickel underplate

Boardlocks—Brass, tin plated over nickel underplate

Threaded Inserts—Brass, nickel plated

Technical Documents:

Product Specification
108-57541



15 Position VESA Receptacle HD-22
Part Number 1734335-1

Note: All part numbers are RoHS compliant.

HD-22 Right-Angle Posted Subminiature D Connectors

Product Facts

- Flame retardant thermoplastic housing material, UL94V-0 rated
- Low cost front metal shell design compatible with full metal-shell connectors
- Integral boardlock versions secure connectors to pc boards prior to soldering
- Contacts available in platings to satisfy different applications
- Integral threaded inserts and screwlocks available
- Recognized under the Component Program of Underwriters Laboratories, Inc., File No. E28476



HD-22 Front Metal Shell .350 [8.89] PCB Footprint



Plug



Receptacle

HD-22 Right-Angle Posted Subminiature D Connectors (Continued)

Material and Finish:

Housing—94V-0 rated thermoplastic, black

▲ VESA Std. 15-position Receptacle Housing Material—Thermoplastic 94V-0 blue per VESA Std.

Shell—Steel, nickel plated

Contacts

Pins—Brass

Sockets—Phosphor bronze

Contact Plating—

Gold flash, .000010 [0.00025] or .000030 [0.00076] on mating end, tin on solder tails with overall nickel underplate

Boardlocks—Brass, tin plated

Female Screwlocks—Brass, nickel plated

Threaded Inserts—Brass, nickel plated

Technical Documents:

Product Specification—108-1092

Application Specification—114-13198

See customer drawings for printed circuit board layouts.

■ Recognized under the Component Program of Underwriters Laboratories, Inc., File No. E28476



Right-Angle Plug

No. of Contact Positions	Dimensions			Mounting Hardware	PCB Mounting Style	Part Numbers		
	A	B	C			Gold Flash	15µ" Gold	30µ" Gold
15	1.212	.984	.582	4-40 inserts	board locks	—	5749767-2	5749767-1
	30.81	24.99	14.80	4-40 screw locks	board locks	5749768-3	5749768-2	5749768-1
26	1.543	1.312	.583	4-40 inserts	board locks	5749769-3	5749769-2	5749769-1
44	2.089	1.852	.593	4-40 inserts	board locks	5749771-3	5749771-2	5749771-1
62	2.732	2.500	.593	4-40 inserts	board locks	5749639-3	5749639-2	5749639-1
78	2.638	2.400	.693	4-40 screw locks	board locks	5749234-3	5749234-2	—
	67.00	61.00	17.60					



Right-Angle Receptacle

No. of Contact Positions	Dimensions			Mounting Hardware	PCB Mounting Style	Part Numbers		
	A	B	C			Gold Flash	15µ" Gold	30µ" Gold
15	1.212	.984	.630	4-40 inserts	board locks	1-1734530-1	1-1734530-2	1-1734530-3
	30.81	25.00	16.00	4-40 screw locks	board locks	1734530-1	1734530-2	1734530-3
▲ 15 VESA	1.212	.984	.630	4-40 inserts	board locks	1734344-1	—	2-1734344-3
	30.81	25.00	16.00	4-40 screw locks	board locks	Pending Obs.	Pending Obs.	Pending Obs.
26	1.543	1.311	.593	4-40 inserts	board locks	2-5748481-3	2-5748481-2	5748481-5
	39.20	44.32	15.06	4-40 screw locks	board locks	2-5748481-5	2-5748481-4	5748481-6
44	2.089	1.852	.583	4-40 inserts	board locks	2-5748482-4	2-5748482-3	5748482-5
	53.05	47.04	14.81	4-40 screw locks	board locks	—	2-5748482-5	—
62	2.732	2.500	.583	4-40 inserts	board locks	2-5748394-4	2-5748394-3	5748394-5
	69.40	63.50	14.81	4-40 screw locks	board locks	2-5748394-6	2-5748394-5	5748394-6
78	2.638	2.400	.693	4-40 inserts	board locks	2-5748483-1	2-5748483-0	5748483-5
	67.00	61.00	17.60	4-40 screw locks	board locks	—	2-5748483-2	5748483-6
	67.00	61.00	17.60					

Note: All part numbers are RoHS compliant.

HD-20 Front Metal-Shell Right-Angle Posted Connectors 318 Mount

Post Size—.026 [0.66] Dia. Plug



With Grounding Indents and Grounding Straps



With Threaded Insert



With Fixed Female Screwlock

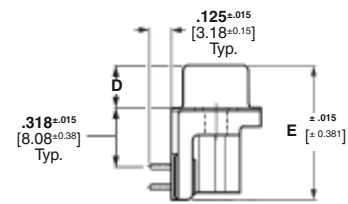

Material and Finish:

- Front Shell**—Steel, tin plated
- Housing**—94V-0 rated thermoplastic, black
- Eyelets**—Brass, tin plated
- Threaded Inserts**—Zinc
- Female Screwlock**—Zinc
- Boardlocks**—Copper alloy, tin plated
- Pin Contacts (Posted)**—Brass, duplex plated as follows:
A—.000030 [0.00076] gold on mating end, tin on termination end, with entire contact nickel underplated
B—Gold flash on mating end, tin on termination end, with entire contact nickel underplated

Technical Documents:

- Product Specification**—108-40025
- Application Specification**—114-40010
- See customer drawings for printed circuit board layouts.

- **Recognized under the Component Program of Underwriters Laboratories, Inc., File No. E28476**
- **Certified by Canadian Standards Association, File No. LR 7189**



Shell Size	No. of Contact Positions	Dimensions				Contact Finish (Plating Code)	Plug Part Numbers					
							Without Boardlocks			With Boardlocks		
							With Standard Mounting Holes	With Threaded Inserts	With Fixed Female Screwlocks	With Standard Mounting Holes	With Threaded Inserts	With Fixed Female Screwlocks
1	9	1.213 30.81	.984 24.99	.235 5.97	.733 18.62	A	5747250-2	5747250-4	5747250-6	5747840-2	5747840-4	5747840-6
						B	—	5747250-3	—	5747840-3	5747840-5	
2	15	1.541 39.14	1.312 33.33	.235 5.97	.733 18.62	A	5747236-2	5747236-4	5747236-6	5747841-2	5747841-4	5747841-6
						B	—	5747236-4	—	5747841-3	—	
3	25	2.088 53.04	1.852 47.04	.230 5.84	.738 18.75	A	5747238-2	5747238-4	5747238-6	5747842-2	5747842-4	5747842-6
						B	5747238-2	5747238-3	—	5747842-3	5747842-5	
4	37	2.729 69.32	2.500 63.50	.230 5.84	.740 18.80	A	—	5747252-4	—	5747843-2	5747843-4	5747843-6
						B	—	—	—	5747843-3	—	

- Notes:**
1. All plug connectors are preloaded with size 20 DF posted pin contacts.
 2. Recommended pc board thickness is .062 [1.58] for connectors with boardlocks and .093 [2.36] max. for all others.
 3. Male screw retainers are used as mating hardware for connectors with 4-40 female screwlocks.

Note: All part numbers are RoHS compliant.

HD-20 Front Metal-Shell Right-Angle Posted Connectors 318 Mount (Continued)

Post Size—.026 [0.66] Dia. Receptacle



With Grounding Straps



With Threaded Insert



With Fixed Female Screwlock

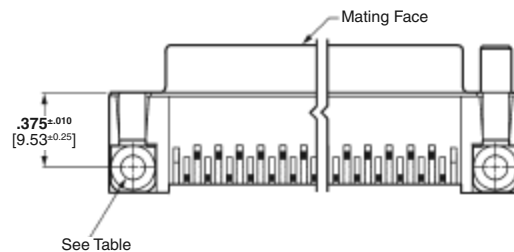
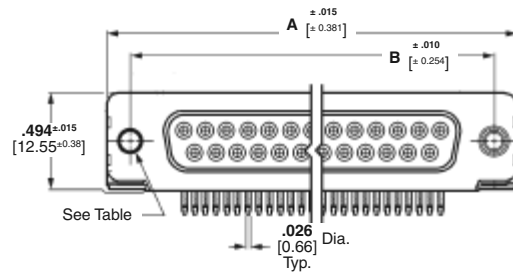

Material and Finish:

- Front Shell**—Steel, tin plated
- Housing**—94V-0 rated thermoplastic, black
- Eyelets**—Brass, tin plated
- Threaded Inserts**—Zinc
- Female Screwlock**—Zinc
- Boardlocks**—Copper alloy, tin plated
- Socket Contacts (Posted)**—Phosphor bronze, duplex plated as follows:
 - A**—.000030 [0.00076] gold on mating end, tin on termination end, with entire contact nickel underplated
 - B**—Gold flash on mating end, tin on termination end, with entire contact nickel underplated

Technical Documents:

- Product Specification**—108-40025
- Application Specification**—114-40010

Shell Size	No. of Contact Positions	Dimensions		Contact Finish (Plating Code)	Receptacle Part Numbers					
					Without Boardlocks			With Boardlocks		
					With Standard Mounting Holes	With Threaded Inserts	With Fixed Female Screwlocks	With Standard Mounting Holes	With Threaded Inserts	With Fixed Female Screwlocks
1	9	1.213 30.81	.984 24.99	A	5745781-2	5745781-4	5745781-6	5747844-2	5747844-4	5747844-6
				B	—	5745781-3	—	—	5747844-3	5747844-5
2	15	1.541 39.14	1.312 33.33	A	5745782-2	5745782-4	5745782-6	—	5747845-4	5747845-6
				B	—	—	—	—	5747845-3	5747845-5
3	25	2.088 53.04	1.852 47.04	A	5745783-2	5745783-4	5745783-6	5747846-2	5747846-4	5747846-6
				B	—	5745783-3	5745783-5	—	5747846-3	5747846-5
4	37	2.729 69.32	2.500 63.50	A	5745784-2	5745784-4	5745784-6	—	5747847-4	5747847-6

- Notes:**
- All receptacle connectors are preloaded with size 20 DF posted socket contacts.
 - Recommended pc board thickness is .062 [1.58] for connectors with boardlocks and .093 [2.36] max. for all others.
 - Male screw retainers are used as mating hardware for connectors with 4-40 female screwlocks.

Note: All part numbers are RoHS compliant.

HD-20 Front Metal-Shell Right-Angle Posted Connectors 318 Mount (Continued)

Post Size—.026 [0.66] Dia.

Plug



With Grounding Indents and Grounding Straps



With Threaded Insert



With Fixed Female Screwlock

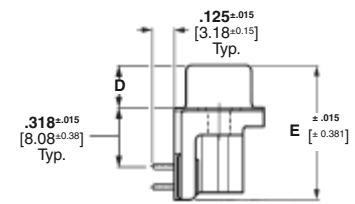
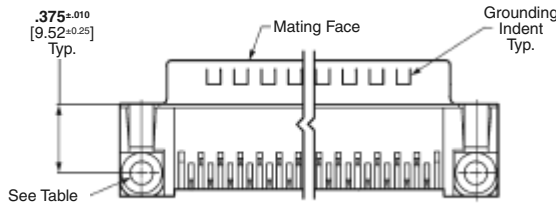
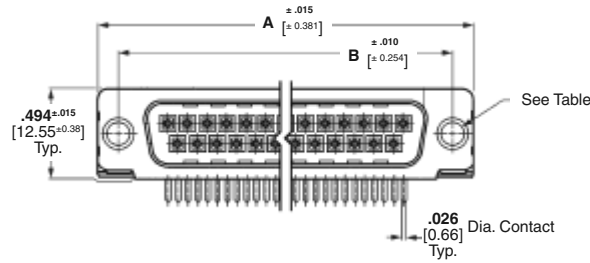

Material and Finish:

- Front Shell**—Steel, tin plated
- Housing**—94V-0 rated thermoplastic, compatible with standard wave, vapor phase, and infra-red reflow (SMT) soldering, black
- Eyelets**—Brass, tin plated
- Threaded Inserts**—Zinc
- Female Screwlock**—Zinc
- Boardlocks**—Copper alloy, tin plated
- Pin Contacts (Posted)**—Brass, duplex plated as follows:
 - A**—.000030 [0.00076] gold on mating end, tin on termination end, with entire contact nickel underplated
 - B**—Gold flash on mating end, tin on termination end, with entire contact nickel underplated

Technical Documents:

- Product Specification**—108-40025
- Application Specification**—114-40010

Shell Size	No. of Contact Positions	Dimensions				Contact Finish (Plating Code)	Plug Part Numbers With Boardlocks	
		A	B	D	E		With Threaded Inserts	With Fixed Female Screwlocks
1	9	1.213	.984	.235	.733	A	5788792-1	5788793-1
		30.81	24.99	5.97	18.62	B	5788792-2	5788793-2
3	25	2.088	1.852	.230	.738	A	5788794-1	5788795-1
		53.04	47.04	5.84	18.75	B	5788794-2	—

- Notes:**
1. All plug connectors are preloaded with size 20 DF posted pin contacts.
 2. Recommended pc board thickness is .062 [1.58] for connectors with boardlocks and .093 [2.36] max. for all others.
 3. Male screw retainers are used as mating hardware for connectors with 4-40 female screwlocks.

Note: All part numbers are RoHS compliant.

.318 [8.08] Board Mount Footprint

HD-20 Front Metal-Shell Right-Angle Posted Connectors 318 Mount (Continued)

Post Size— .026 [0.66] Dia.

Receptacle



With Grounding Straps



With Threaded Insert



With Fixed Female Screwlock

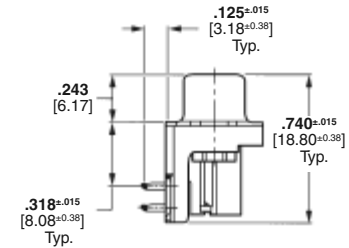
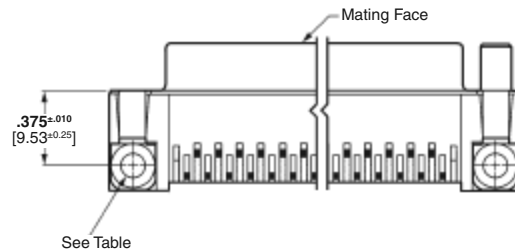
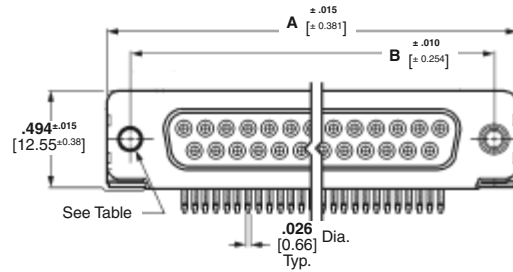

Material and Finish:

- Front Shell**—Steel, tin plated
- Housing**—94V-0 rated thermoplastic, compatible with standard wave, vapor phase, and infra-red reflow (SMT) soldering, black
- Eyelets**—Brass, tin plated
- Threaded Inserts**—Zinc
- Female Screwlock**—Zinc
- Boardlocks**—Copper alloy, tin plated
- Socket Contacts (Posted)**—Phosphor bronze, duplex plated as follows:
 - A**—.000030 [0.00076] gold on mating end, tin on termination end, with entire contact nickel underplated
 - B**—Gold flash on mating end, tin on termination end, with entire contact nickel underplated

- Technical Documents:**
- Product Specification**—108-40025
- Application Specification**—114-40010

Shell Size	No. of Contact Positions	Dimensions		Contact Finish (Plating Code)	Receptacle Part Numbers		
		A	B		Without Boardlocks		With Boardlocks
					With Fixed Female Screwlocks	With Threaded Inserts	With Fixed Female Screwlocks
1	9	1.213 30.81	.984 24.99	A	5788803-1	5788796-1	5788797-1
				B	—	5788796-2	5788797-2
2	15	1.541 39.14	1.312 33.33	A	—	5788798-1	5788799-1
				B	—	5788798-1	—
3	25	2.088 53.04	1.852 47.04	A	—	5788800-1	5788801-1
				B	—	5788800-2	5788801-2
4	37	2.729 69.32	2.500 63.50	A	—	5788802-1	—

- Notes:**
1. All receptacle connectors are preloaded with size 20 DF posted socket contacts.
 2. Recommended pc board thickness is .062 [1.58] for connectors with boardlocks and .093 [2.36] max. for all others.
 3. Male screw retainers are used as mating hardware for connectors with 4-40 female screwlocks.

Note: All part numbers are RoHS compliant.

HD-20 Full Metal-Shell Right-Angle Posted Connectors 454 Mount

Post Size—.025 [0.64] Sq.

Receptacle



Material and Finish:

Shell—Steel, tin plated
Insert—94V-0 rated thermoplastic, black

Contacts (Posted):

Pin—Brass
Socket—Phosphor bronze

Contact Plating:

A—.000030 [0.00076] gold on mating end, tin on termination end, with entire contact nickel underplated
B—Gold flash on mating end, tin on termination end, with entire contact nickel underplated

Technical Documents:

Product Specification—108-40025
Application Specification—114-40013

See customer drawings for printed circuit board layouts.

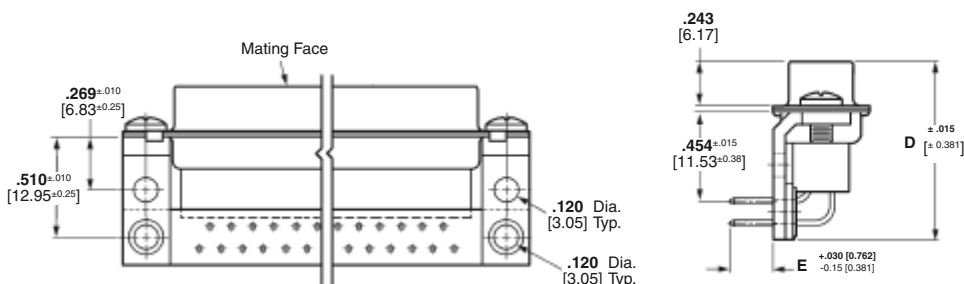
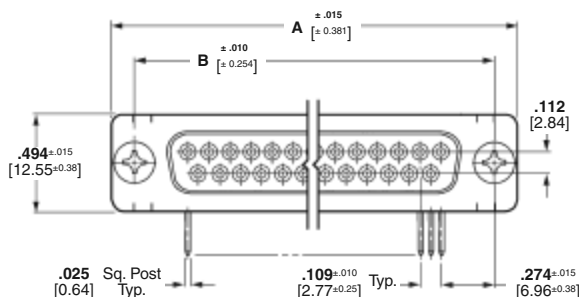

Shell Size	No. of Contact Positions	Dimensions				Contact Finish (Plating Code)	Part Number
		A	B	D	E		
1	9	1.213 30.81	.984 24.99	.915 23.24	.125 3.18	A	5745438-4
					.220 5.59	B	5745438-3
2	15	1.541 39.14	1.312 33.33	.915 23.24	.125 3.18	A	5745439-4
					.220 5.59	A	5745439-2
3	25	2.088 53.04	1.852 47.04	.919 23.34	.125 3.18	A	5745440-4
					.220 5.59	B	5745440-1
4	37	2.729 69.32	2.500 63.50	.919 23.34	.125 3.18	A	5745441-4
					.220 5.59	B	—

- Notes:**
- All connectors are preloaded with size 20 DF posted contacts; plugs with pin contacts and receptacles with socket contacts.
 - .125 [3.18] post length is recommended for pc board thickness of .093 [2.36] max.; .220 [5.59] post length is recommended for pc board thickness of .125 [3.18] max.

Note: All part numbers are RoHS compliant.

.454 [11.53] Board Mount Footprint

HD-20 Full Metal-Shell Right-Angle Posted Connectors 454 Mount (Continued)

Post Size—.025 [0.64] Sq.

Plug



Without Grounding Indents



With Grounding Indents

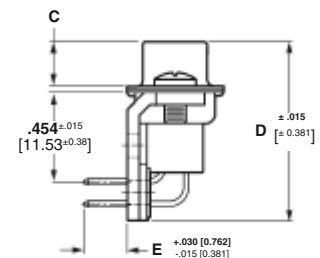

Material and Finish:

Shell—Steel, tin plated
Insert—94V-0 rated thermoplastic, black

Contacts (Posted):
Pin—Brass
Socket—Phosphor bronze

Contact Plating:
A—.000030 [0.00076] gold on mating end, tin on termination end, with entire contact nickel underplated
B—Gold flash on mating end, tin on termination end, with entire contact nickel underplated

Technical Documents:

Product Specification—108-40025
Application Specification—114-40013

Shell Size	No. of Contact Positions	Dimensions					Contact Finish (Plating Code)	Part Numbers With Grounding Indents
		A	B	C	D	E		
1	9	1.213 30.81	.984 24.99	.235 5.97	.915 23.24	.125 3.18	A	5745434-8
						.220 5.59	B	—
2	15	1.541 39.14	1.312 33.33	.235 5.97	.915 23.24	.125 3.18	A	5745435-8
						.220 5.59	A	—
3	25	2.088 53.04	1.852 47.04	.230 5.84	.919 23.34	.125 3.18	A	—
						.220 5.59	B	5745436-3
4	37	2.729 69.32	2.500 63.50	.230 5.84	.919 23.34	.125 3.18	A	5745437-8
						.220 5.59	B	5745437-3

- Notes:**
- All connectors are preloaded with size 20 DF posted contacts; plugs with pin contacts and receptacles with socket contacts.
 - .125 [3.18] post length is recommended for pc board thickness of .093 [2.36] max.; .220 [5.59] post length is recommended for pc board thickness of .125 [3.18] max.

Note: All part numbers are RoHS compliant.

.454 [11.53] Board Mount Footprint

HD-20 Front Metal-Shell Right-Angle Posted Connectors 478 Mount

Post Size—.026 [0.66] Dia. Plug



With Grounding Indents and Grounding Straps



With Threaded Insert



With Fixed Female Screwlock

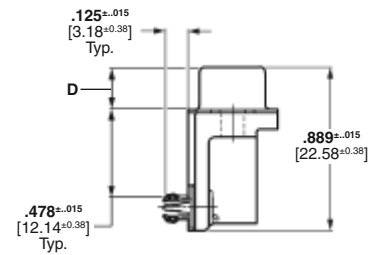
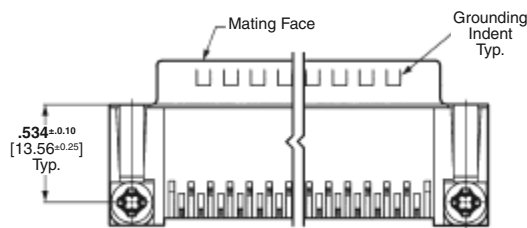
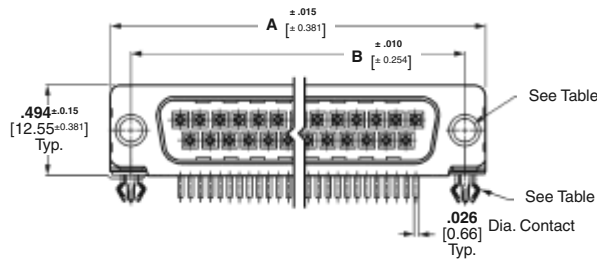

Material and Finish:

- Front Shell**—Steel, tin plated
- Housing**—94V-0 rated thermoplastic, black
- Eyelets**—Brass, tin plated
- Threaded Inserts**—Zinc
- Female Screwlock**—Zinc
- Boardlocks**—Copper alloy, tin plated
- Pin Contacts (Posted)**—Brass, duplex plated as follows:
 - A**—.000030 [0.00076] gold on mating end, tin on termination end, with entire contact nickel underplated
 - B**—Gold flash on mating end, tin on termination end, with entire contact nickel underplated

Technical Documents:

- Product Specification**—108-40025
- Application Specification**—114-40010

See customer drawings for printed circuit board layouts.

Shell Size	No. of Contact Positions	Dimensions			Contact Finish (Plating Code)	Plug Part Number With Boardlocks	
		A	B	D		With Threaded Inserts	With Fixed Female Screwlocks
1	9	1.213 30.81	.984 24.99	.235 5.97	A	5747848-4	—
3	25	2.088 53.04	1.852 47.04	.230 5.84	A	—	5747850-6

- Notes:**
- All plug connectors are preloaded with size 20 DF posted pin contacts.
 - Recommended pc board thickness is .062 [1.58] for connectors with boardlocks and .093 [2.36] max. for all others.
 - Male screw retainers are used as mating hardware for connectors with 4-40 female screwlocks.

Note: All part numbers are RoHS compliant.

.478 [12.14] Board Mount Footprint

HD-20 Front Metal-Shell Right-Angle Posted Connectors 478 Mount (Continued)

Post Size— .026 [0.66] Dia. Receptacle



With Grounding Straps



With Threaded Insert



With Fixed Female Screwlock

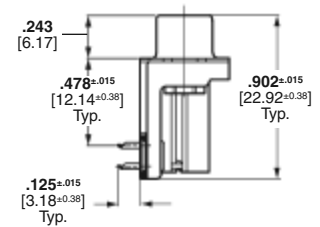
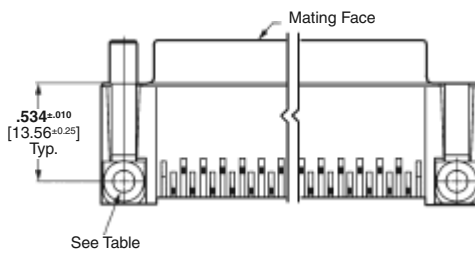
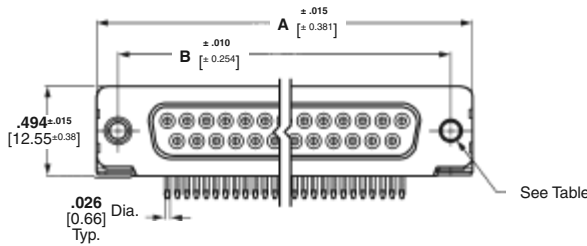

Material and Finish:

- Front Shell**—Steel, tin plated
- Housing**—94V-0 rated thermoplastic, black
- Eyelets**—Brass, tin plated
- Threaded Inserts**—Zinc
- Female Screwlock**—Zinc
- Boardlocks**—Copper alloy, tin plated
- Socket Contacts (Posted)**—Phosphor bronze, duplex plated as follows:
 - A**—.000030 [0.00076] gold on mating end, tin on termination end, with entire contact nickel underplated
 - B**—Gold flash on mating end, tin on termination end, with entire contact nickel underplated

Technical Documents:

- Product Specification**—108-40025
- Application Specification**—114-40010

Shell Size	No. of Contact Positions	Dimensions		Contact Finish (Plating Code)	Receptacle Part Numbers	
		A	B		Without Boardlocks	With Boardlocks
1	9	1.213 30.81	.984 24.99	A	5747418-4 With Threaded Inserts	5747852-4 With Threaded Inserts

- Notes:**
1. All receptacle connectors are preloaded with size 20 DF posted socket contacts.
 2. Recommended pc board thickness is .062 [1.58] for connectors with boardlocks and .093 [2.36] max. for all others.
 3. Male screw retainers are used as mating hardware for connectors with 4-40 female screwlocks.

Note: All part numbers are RoHS compliant.

.478 [12.14] Board Mount Footprint

HD-20 Full Metal-Shell Right-Angle Posted Connectors 545 Mount

Post Size—.025 [0.64] Sq.

Plug



Without Grounding Indents



With Grounding Indents



With 4-40 Female Screwlocks

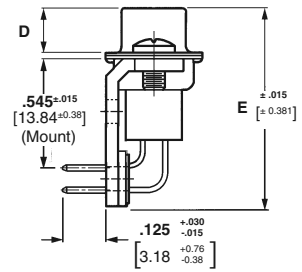
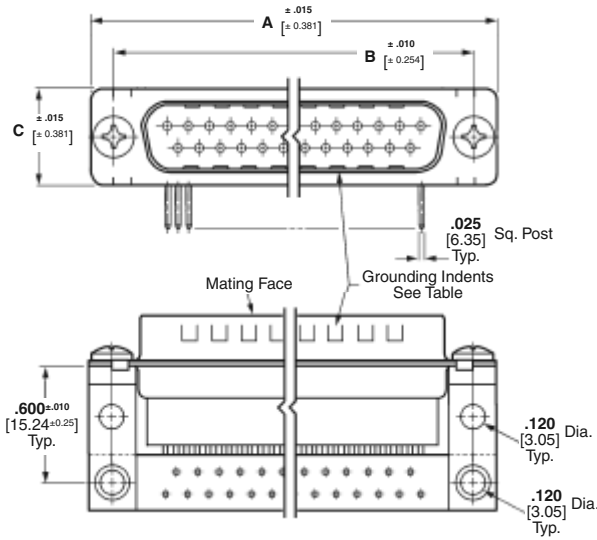

With Standard Mounting Screws

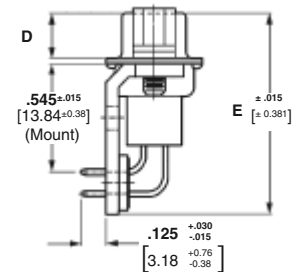

With 4-40 Female Screwlocks

Material and Finish:

- Shell**—Steel, tin plated
- Insert**—94V-0 rated thermoplastic, black
- Female Screwlock**—Steel, zinc plated
- Pin Contacts (Posted)**—Brass, duplex plated as follows:
 - A**—.000030 [0.00076] gold on mating end, tin on termination end, with entire contact nickel underplated
 - B**—Gold flash on mating end, tin on termination end, with entire contact nickel underplated

Technical Documents:

- Product Specification**—108-40025
- Application Specification**—114-40013

See customer drawings for printed circuit board layouts.

Shell Size	No. of Contact Pos.	Dimensions					Contact Finish (Plating Code)	Plug Part Numbers		
		A	B	C	D	E		Without Grounding Indents	With Grounding Indents	
		With Standard Mounting Screws*	With Standard Mounting Screws	With Female Screwlocks						
1	9	1.213 30.81	.984 24.99	.494 12.55	.235 5.99	1.025 26.04	A	5745351-2	5745351-4	5747197-4
2	15	1.541 39.14	1.312 33.33	.494 12.55	.235 5.99	1.025 26.04	A B	— 5745352-1	5745352-4	— —
3	25	2.088 53.04	1.852 47.04	.494 12.55	.230 5.84	1.029 26.14	A	—	—	5747022-2
4	37	2.729 69.32	2.500 63.50	.494 12.55	.230 5.84	1.029 26.14	A	—	5745354-4	—
5	50	2.635 66.93	2.406 61.11	.605 15.37	.230 5.84	1.149 29.19	A	—	5745355-4	5747497-4

*These plugs can be made available with female screwlocks, consult TE.

- Notes:**
- All plugs are preloaded with size 20 DF posted pin contacts.
 - Recommended pc board thickness is .093 [2.36] max.
 - Male screw retainers are used as mating hardware for connectors with 4-40 female screwlocks.

Note: All part numbers are RoHS compliant.

.545 [13.84] Board Mount Footprint

HD-20 Full Metal-Shell Right-Angle Posted Connectors 545 Mount (Continued)

Post Size—.025 [0.64] Sq.

Receptacle



With 4-40 Female Screwlocks

Material and Finish:

- Shell**—Steel, tin plated
- Insert**—94V-0 rated thermoplastic, black
- Female Screwlock**—Steel, zinc plated

Socket Contacts (Posted)—Phosphor bronze, duplex plated as follows:

- A**—.000030 [0.00076] gold on mating end, tin on termination end, with entire contact nickel underplated
- B**—Gold flash on mating end, tin on termination end, with entire contact nickel underplated

Technical Documents:

- Product Specification**—108-40025
- Application Specification**—114-40013

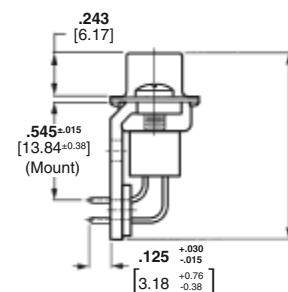
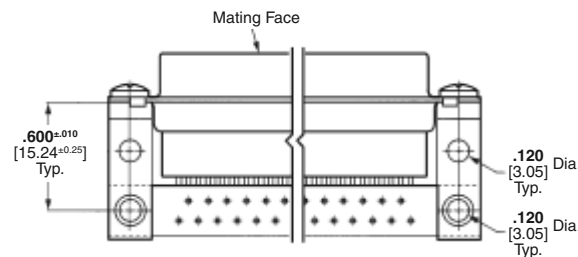
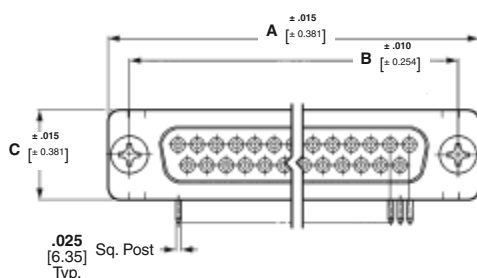

Shell Size	No. of Contact Positions	Dimensions				Contact Finish (Plating Code)	Receptacle Part Numbers	
		A	B	C	E		With Standard Mounting Screws	With Female Screwlocks
1	9	1.213	.984	.494	1.033	A	5745112-2	5747020-2
		30.81	24.99	12.55	26.24	B	—	5747020-1
2	15	1.541	1.312	.494	1.033	A	5745113-2	5747021-2
		39.14	33.33	12.55	26.24			
3	25	2.088	1.852	.494	1.033	A	5745114-2	5745536-2
		53.04	47.04	12.55	26.24			
4	37	2.729	2.500	.494	1.033	A	5745115-2	—
		69.32	63.50	12.55	26.24			
5	50	2.635	2.406	.605	1.153	A	5745116-2	5747193-2
		66.93	61.11	15.37	29.29	B	5745116-1	5747193-1

- Notes:**
- All receptacles are preloaded with size 20 DF posted socket contacts.
 - Recommended pc board thickness is .093 [2.36] max.
 - Male screw retainers are used as mating hardware for connectors with 4-40 female screwlocks.

Note: All part numbers are RoHS compliant.

HD-20 Front Metal-Shell Right-Angle Posted Connectors 590 Mount

Post Size—.026 [0.66] Dia. Plug



With Grounding Indents and Grounding Straps



With Threaded Insert



With Fixed Female Screwlock

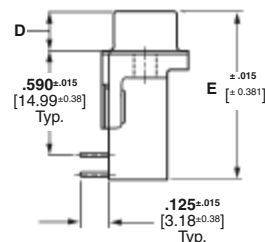
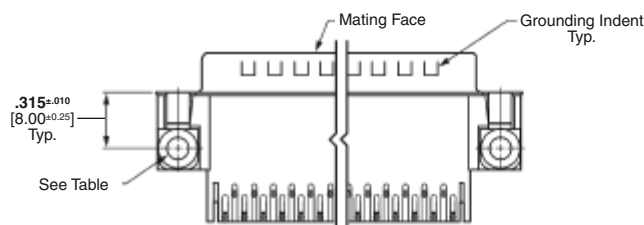
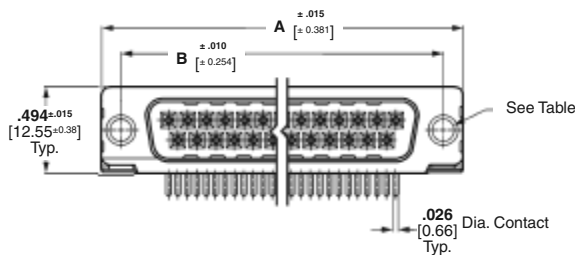

Material and Finish:

- Front Shell**—Steel, tin plated
- Housing**—94V-0 rated thermoplastic, black
- Eyelets**—Brass, tin plated
- Threaded Inserts**—Zinc
- Female Screwlock**—Zinc
- Boardlocks**—Copper alloy, tin plated
- Pin Contacts (Posted)**—Brass, duplex plated as follows:
 - A**—.000030 [0.00076] gold on mating end, tin on termination end, with entire contact nickel underplated
 - B**—Gold flash on mating end, tin on termination end, with entire contact nickel underplated

Technical Documents:

- Product Specification**—108-40025
- Application Specification**—114-40010

.590 [14.99] Board Mount Footprint

Shell Size	No. of Contact Positions	Dimensions				Contact Finish (Plating Code)	Plug Part Numbers		
		A	B	D	E		Without Boardlocks		With Boardlocks
							With Threaded Inserts	With Threaded Inserts	With Fixed Female Screwlocks
1	9	1.213 30.81	.984 24.99	.235 5.97	.965 24.51	A	5745990-4	5747832-4	5747832-6
						B	5745990-3	5747832-3	—
2	15	1.541 39.14	1.312 33.33	.235 5.97	.965 24.51	A	—	5747833-4	5747833-6
3	25	2.088 53.04	1.852 47.04	.230 5.84	.970 24.64	A	5745994-4	5747834-4	5747834-6
4	37	2.729 69.32	2.500 63.50	.230 5.84	.972 24.69	A	—	5747835-4	5747835-6

- Notes:**
- All plug connectors are preloaded with size 20 DF posted pin contacts.
 - Recommended pc board thickness is .062 [1.58] for connectors with boardlocks and .093 [2.36] max. for all others.
 - Male screw retainers are used as mating hardware for connectors with 4-40 female screwlocks.

Note: All part numbers are RoHS compliant.

HD-20 Front Metal-Shell Right-Angle Posted Connectors 590 Mount (Continued)

Post Size—.026 [0.66] Dia. Receptacle



With Grounding Straps



With Threaded Insert



With Fixed Female Screwlock

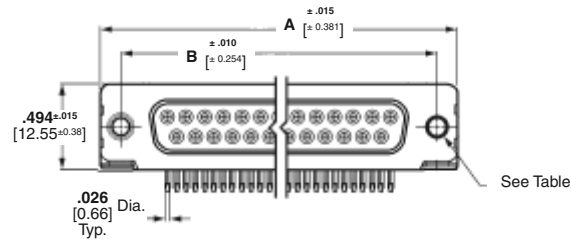

Material and Finish:

- Front Shell**—Steel, tin plated
- Housing**—94V-0 rated thermoplastic, black
- Eyelets**—Brass, tin plated
- Threaded Inserts**—Zinc
- Female Screwlock**—Zinc
- Boardlocks**—Copper alloy, tin plated
- Socket Contacts (Posted)**—Phosphor bronze, duplex plated as follows:
 - A**—.000030 [0.00076] gold on mating end, tin on termination end, with entire contact nickel underplated
 - B**—Gold flash on mating end, tin on termination end, with entire contact nickel underplated

Technical Documents:

- Product Specification**—108-40025
- Application Specification**—114-40010

Shell Size	No. of Contact Positions	Dimensions		Contact Finish (Plating Code)	Receptacle Part Numbers			
		A	B		Without Boardlocks		With Boardlocks	
					With Threaded Inserts	With Fixed Female Screwlocks	With Threaded Inserts	With Fixed Female Screwlocks
1	9	1.213 30.81	.984 24.99	A	5745988-4	5745988-6	5747836-4	5747836-6
2	15	1.541 39.14	1.312 33.33	A	5745984-4	—	5747837-4	—
3	25	2.088 53.04	1.852 47.04	A	—	5745992-6	5747838-4	5747838-6
				B	5745992-3	—	5747838-3	—
4	37	2.729 69.32	2.500 63.50	A	5745996-4	—	5747839-4	—

- Notes:**
1. All receptacle connectors are preloaded with size 20 DF posted socket contacts.
 2. Recommended pc board thickness is .062 [1.58] for connectors with boardlocks and .093 [2.36] max. for all others.
 3. Male screw retainers are used as mating hardware for connectors with 4-40 female screwlocks.

Note: All part numbers are RoHS compliant.

.590 [14.99] Board Mount Footprint

HD-20 All-Plastic Right-Angle Posted Connectors 318 Mount

Receptacle—With Boardlocks



With Threaded Insert

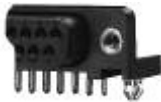

With Threaded Insert



With Fixed Female Screwlock

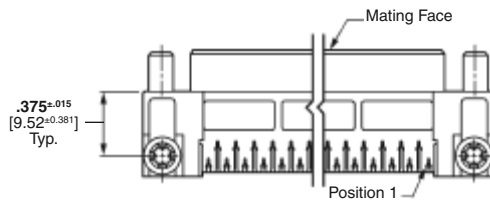
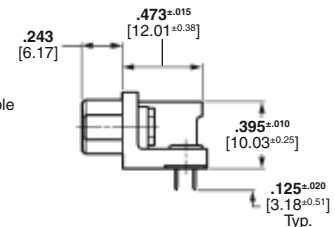
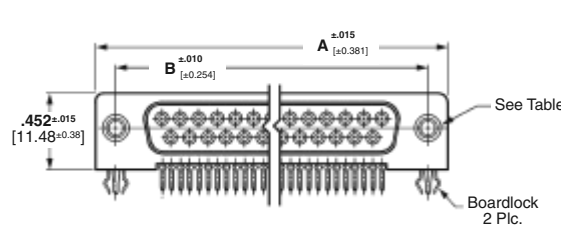
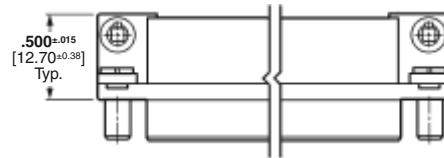

Material and Finish:

Housing—94V-0 rated thermoplastic, black

Eyelets—Brass, tin plated

Threaded Inserts—Zinc

Female Screwlock—Zinc

Boardlock—Copper alloy, tin plated

Socket Contacts (Posted)—Phosphor bronze, duplex plated as follows:

A—.000030 [0.00076] gold on mating end, tin on termination end, with entire contact nickel underplated

Technical Documents:

Product Specification—108-1226

Application Specification—114-40027

See customer drawings for printed circuit board layouts.

Shell Size	No. of Contact Positions	Dimensions		Contact Finish (Plating Code)	Part Numbers	
		A	B		With Threaded Inserts	With Fixed Female Screwlocks
1	9	1.222 31.04	.984 24.99	A	—	5748979-1
3	25	2.090 53.09	1.852 47.04	A	5748901-1	5748981-1

Consult TE for availability.

- Notes:**
1. All receptacle connectors are preloaded with size 20 DF posted socket contacts.
 2. Recommended pc board thickness is .062 [1.58].
 3. Male screw retainers are used as mating hardware for connectors with 4-40 female screwlocks.

Note: All part numbers are RoHS compliant.

HD-20 All-Plastic Right-Angle Posted Connectors 318 Mount (Continued)

Plug



With Threaded Insert

Material and Finish:

Housing—94V-0 rated thermoplastic, black

Eyelets—Brass, tin plated

Threaded Inserts—Zinc

Boardlock—Copper alloy, tin plated

Pin Contacts (Posted)—Copper alloy, duplex plated as follows:

A—.000030 [0.00076] gold on mating end, tin on termination end, with entire contact nickel underplated

B—.000010 [0.00025] min. gold on mating end, tin on termination end, with entire contact nickel underplated

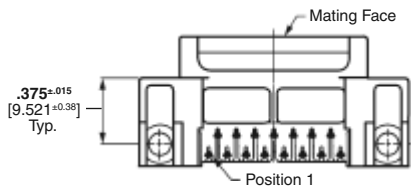
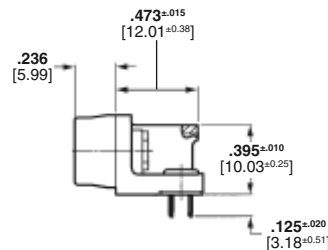
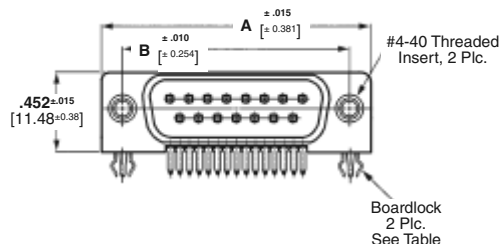
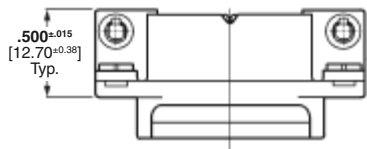

Technical Documents:

Product Specification—108-1226

Application Specification—114-40027

See customer drawings for printed circuit board layouts.

Shell Size	No. of Contact Positions	Dimensions		Contact Finish (Plating Code)	Part Numbers With Threaded Inserts	
		A	B		With Boardlocks	Without Boardlocks
2	15	1.550 39.37	1.312 33.32	A	5748904-1	—
3	25	2.090 53.09	1.852 47.04	B	—	5748865-3

Consult TE for availability.

- Notes:**
1. All plug connectors are preloaded with size 20 DF posted pin contacts.
 2. Recommended pc board thickness is .062 [1.58].
 3. Male screw retainers are used as mating hardware for connectors with 4-40 female screwlocks.

Note: All part numbers are RoHS compliant.

HD-20 All-Plastic Right-Angle Posted Connectors 318 Mount (Continued)

Post Size—.026 [0.66] Dia. Receptacle—Without Boardlocks



With Standard Mounting Holes



With Threaded Insert



With Fixed Female Screwlock

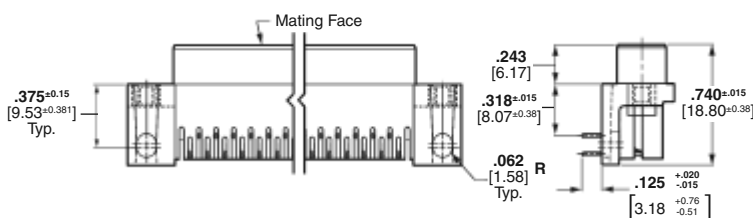
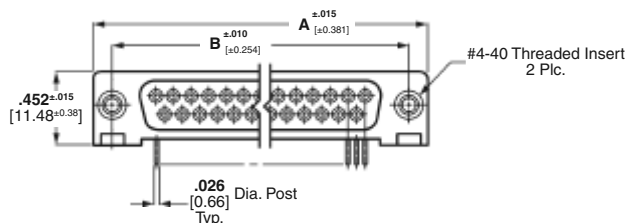

Material and Finish:

Housing—94V-0 rated thermoplastic, black

Threaded Inserts—Zinc, chromate coated

Female Screwlocks—Zinc, chromate coated

Socket Contacts (Posted)—Phosphor bronze, duplex plated as follows:

A—.000030 [0.00076] gold on mating end, tin on termination end, with entire contact nickel underplated

B—Gold flash on mating end, tin on termination end, with entire contact nickel underplated

Technical Documents:

Product Specification—108-40025

Application Specification—114-40015

See customer drawings for printed circuit board layouts.

Shell Size	No. of Contact Positions	Dimensions		Contact Finish (Plating Code)	Part Numbers		
		A	B		With Threaded Inserts	With Fixed Female Screwlocks	With .125 [3.18] Mounting Holes
1	9	1.213 30.81	.984 24.99	A	5745394-2	5745395-2	—
				B	—	—	5745131-1
2	15	1.541 39.14	1.312 33.32	A	—	5745396-2	5745396-2
				B	—	—	—
3	25	2.088 53.04	1.852 47.04	A	5745392-2	5745397-2	5745132-2
				B	—	—	—

- Notes:**
1. All receptacle connectors are preloaded with size 20 DF posted socket contacts.
 2. Recommended pc board thickness is .093 [2.36].
 3. Male screw retainers are used as mating hardware for connectors with 4-40 female screwlocks.

Note: All part numbers are RoHS compliant.

HD-20 All-Plastic Right-Angle Posted Connectors 590 Mount

Receptacle—With Boardlocks



With Threaded Insert



With Fixed Female Screwlock

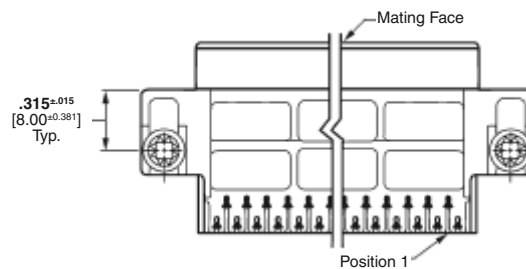
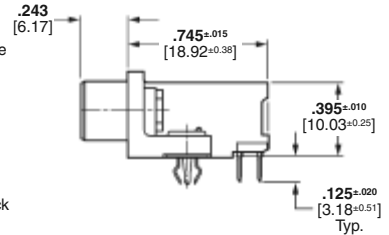
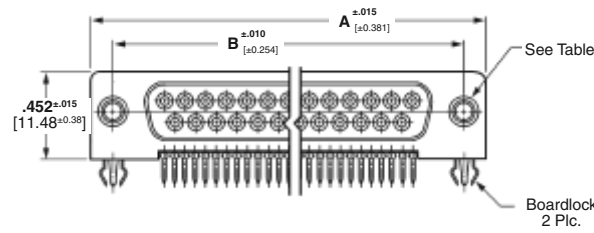
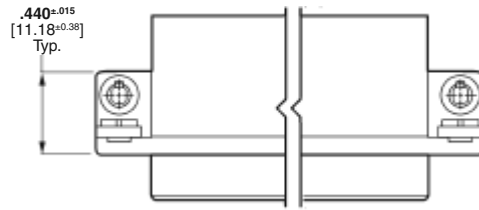

Material and Finish:

Housing—94V-0 rated thermoplastic, black

Eyelets—Brass, tin plated

Threaded Inserts—Zinc

Female Screwlock—Zinc

Boardlock—Copper alloy, tin plated

Socket Contacts (Posted)—Phosphor bronze, duplex plated as follows:

A—.000030 [0.00076] gold on mating end, tin on termination end, with entire contact nickel underplated

B—Gold flash on mating end, tin on termination end, with entire contact nickel underplated

Technical Documents:

Product Specification—108-1226

Application Specification—114-40027

See customer drawings for printed circuit board layouts.

Shell Size	No. of Contact Positions	Dimensions		Contact Finish (Plating Code)	Part Numbers	
		A	B		With Threaded Inserts	With Fixed Female Screwlocks
1	9	1.213 30.81	.984 24.99	B	5748907-2	—
3	25	2.088 53.04	1.852 47.04	A	5748909-1	5748989-1

- Notes:**
- All receptacle connectors are preloaded with size 20 DF posted socket contacts.
 - Recommended pc board thickness is .062 [1.58].
 - Male screw retainers are used as mating hardware for connectors with 4-40 female screwlocks.

Note: All part numbers are RoHS compliant.

HD-20 All-Plastic Right-Angle Posted Connectors 590 Mount (Continued)

Post Size—.026 [0.66] Dia. **Receptacle—Without Boardlocks**



With Threaded Insert

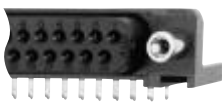

With Female Screwlock

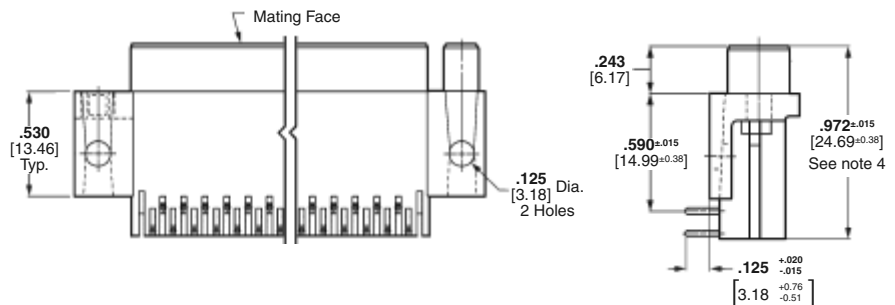
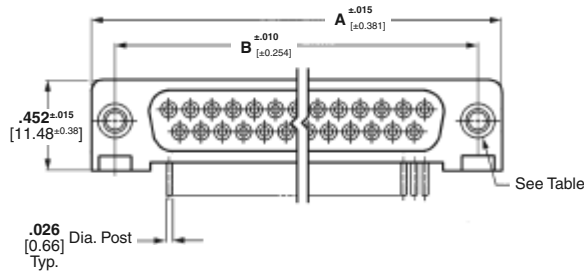

Material and Finish:

Housing—94V-0 rated thermoplastic, black

Threaded Inserts—Zinc, chromate coated

Female Screwlocks—Zinc, chromate coated

Socket Contacts (Posted)—Phosphor bronze, duplex plated as follows:

A—0.00030 [0.00076] gold on mating end, tin on termination end, with entire contact nickel underplated

B—Gold flash on mating end, tin on termination end, with entire contact nickel underplated

Technical Documents:

Product Specification—108-40025

Application Specification—114-40015

See customer drawings for printed circuit board layouts.

Shell Size	No. of Contact Positions	Dimensions		Contact Finish (Plating Code)	Part Numbers		
		A	B		With Threaded Inserts	With Fixed Female Screwlocks	With .125 [3.18] Mounting Holes
1	9	1.213	.984	A	5747459-4	5747459-6	5747459-2
		30.81	24.99	B	5747459-3	5747459-5	5747459-1
2	15	1.541	1.312	A	5747460-4	5748948-1	5747460-2
		39.14	33.32	B	5747460-3	5747460-5	5747460-1
3	25	2.088	1.852	A	5747461-4	5747461-6	5747461-2
		53.04	47.04	B	5747461-3	5747461-5	5747461-1
4	37	2.729	2.500	A	5747462-4	5747462-6	5747462-2
		69.32	63.50	B	—	—	—
5	50	2.635	2.406	A	—	—	5206973-1
		66.93	61.11	B	—	—	5206973-2

- Notes:**
- All receptacle connectors are preloaded with size 20 DF posted socket contacts.
 - Recommended pc board thickness is .093 [2.36] max.
 - Male screw retainers are used as mating hardware for connectors with 4-40 female screwlocks.
 - Dimension is 1.120 [28.45] for size 5 d-sub.

Note: All part numbers are RoHS compliant.

HD-20 All-Plastic Right-Angle Posted Connectors 590 Mount (Continued)

Post Size—.026 [0.66] Dia. Plug—Without Boardlocks



With Threaded Insert



With Female Screwlocks

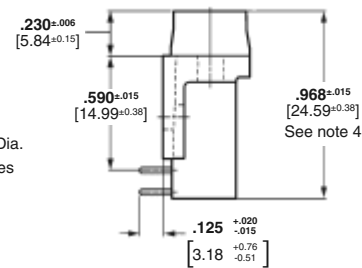
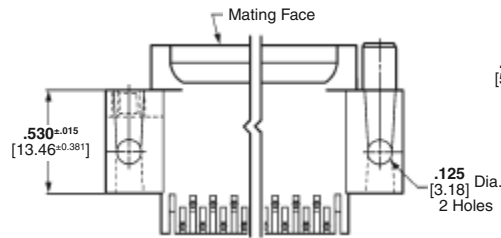

Material and Finish:

Housing—94V-0 rated thermoplastic, black

Threaded Inserts—Zinc, chromate coated

Female Screwlocks—Zinc, chromate coated

Pin Contacts (Posted)—Brass, duplex plated as follows:
A—.000030 [0.00076] gold on mating end, tin on termination end, with entire contact nickel underplated
B—Gold flash on mating end, tin on termination end, with entire contact nickel underplated

Technical Documents:

Product Specification—108-40025

Application Specification—114-40015

See customer drawings for printed circuit board layouts.

Shell Size	No. of Contact Positions	Dimensions		Contact Finish (Plating Code)	Part Numbers		
		A	B		With Threaded Inserts	With Fixed Female Screwlocks	With .125 [3.18] Mounting Holes
1	9	1.213	.984	A	5747467-4	—	5747467-2
		30.81	24.99	B	—	—	5747467-1
2	15	1.541	1.312	A	5748872-1	5748952-1	5747468-2
		39.14	33.32	B	—	—	5748826-1
3	25	2.090	1.852	A	5748873-1	5748953-1	5748826-1
		53.09	47.04	B	—	—	5748826-2
4	37	2.729	2.500	A	—	—	5747470-2
		69.32	63.50	B	—	—	5206971-1
5	50	2.635	2.406	A	—	—	5206971-1
		66.93	61.11	B	—	—	5206971-2

- Notes:**
- All plug connectors are preloaded with size 20 DF posted pin contacts.
 - Recommended pc board thickness is .093 [2.36] max.
 - Male screw retainers are used as mating hardware for connectors with 4-40 female screwlocks.
 - Dimension is 1.115 [28.32] for size 5 d-sub, GPL244.

Note: All part numbers are RoHS compliant.

Right-Angle Mounting Connectors — European Standard Footprint



Material and Finish:

Front Shell—Steel, tin plated

Housing—Black glass-filled polyester

Flammability—UL 94V-0

Contact Material—

Pin—Phosphor bronze

Socket—Phosphor bronze

Contact Area Plating—0.76µm Gold

Current Rating—6A max.

Insulation Resistance—
5000 MΩ min.

Dielectric Strength—1000V AC min.

Temperature Rating—
-55°C to +105°C

Plug with Boardlocks — Solder Termination

No of Ways	3mm Hole	4-40 Inserts	4-40 Screwlocks	M3 Inserts	M3 Screwlocks
9	338168-2	1-338168-2	3-338168-2	2-338168-2	4-338168-2
15	338169-2	1-338169-2	3-338169-2	2-338169-2	4-338169-2
25	338170-2	1-338170-2	3-338170-2	2-338170-2	4-338170-2
37	338171-2	1-338171-2	3-338171-2	2-338171-2	4-338171-2

Socket with Boardlocks — Solder Termination

No of Ways	3mm Hole	4-40 Inserts	4-40 Screwlocks	M3 Inserts	M3 Screwlocks
9	106505-2	1-106505-2	3-106505-2	2-106505-2	4-106505-2
15	106506-2	1-106506-2	3-106506-2	2-106506-2	4-106506-2
25	106507-2	1-106507-2	3-106507-2	2-106507-2	4-106507-2
37	106508-2	1-106508-2	3-106508-2	2-106508-2	4-106508-2

Plug without Boardlocks — Solder Termination

No of Ways	3mm Hole	4-40 Inserts	4-40 Screwlocks	M3 Inserts	M3 Screwlocks
9	5-338168-2	6-338168-2	8-338168-2	7-338168-2	9-338168-2
15	5-338169-2	6-338169-2	8-338169-2	7-338169-2	9-338169-2
25	5-338170-2	6-338170-2	8-338170-2	7-338170-2	9-338170-2
37	5-338171-2	6-338171-2	8-338171-2	7-338171-2	9-338171-2

Socket without Boardlocks — Solder Termination

No of Ways	3mm Hole	4-40 Inserts	4-40 Screwlocks	M3 Inserts	M3 Screwlocks
9	5-106505-2	6-106505-2	8-106505-2	7-106505-2	9-106505-2
15	5-106506-2	6-106506-2	8-106506-2	7-106506-2	9-106506-2
25	5-106507-2	6-106507-2	8-106507-2	7-106507-2	9-106507-2
37	5-106508-2	6-106508-2	8-106508-2	7-106508-2	9-106508-2

Note: All part numbers are RoHS compliant.

Right-Angle Mounting Connectors — Eurostyle Footprint



Material and Finish:

Front Shell—Steel, tin plated

Housing—Grey thermoplastic PBTP

Flammability—UL 94V-0

Contact Material—

Pin—Copper alloy

Socket—Copper alloy

Contact Area Plating—Nickel/Gold
(>250 mating cycles)

Current Rating—2.2A

Insulation Resistance—
5000 MΩ min.

Dielectric Strength—1000V AC

Temperature Rating—
-55°C to +125°C

Plug with Boardlocks — Solder Termination

No of Ways	3mm Hole	4-40 Inserts	4-40 Screwlocks	M3 Inserts	M3 Screwlocks
9	5-1393480-9	8-1393480-5	1393481-5	7-1393480-4	9-1393480-4
15	6-1393480-0	8-1393480-6	3-1392010-3	7-1393480-5	9-1393480-5
25	On Enquiry	8-1393480-7	1393481-6	7-1393480-6	9-1393480-6
37	On Enquiry	8-1393480-8	3-1392010-4	7-1393480-7	On Enquiry

Socket with Boardlocks — Solder Termination

No of Ways	3mm Hole	4-40 Inserts	4-40 Screwlocks	M3 Inserts	M3 Screwlocks
9	5-1393480-5	8-1393480-1	9-1393480-9	6-1393480-7	9-1393480-0
15	5-1393480-6	8-1393480-2	1393481-1	6-1393480-8	9-1393480-1
25	5-1393480-7	8-1393480-3	1393481-2	6-1393480-9	9-1393480-2
37	On Enquiry	8-1393480-4	3-1392010-7	7-1393480-0	On Enquiry

Plug without Boardlocks — Solder Termination

No of Ways	3mm Hole	4-40 Inserts	4-40 Screwlocks	M3 Inserts	M3 Screwlocks
9	2-1393480-1	4-1393480-0	5-1393480-2	3-1393480-2	On Enquiry
15	2-1393480-2	4-1393480-1	5-1393480-3	3-1393480-3	On Enquiry
25	2-1393480-3	4-1393480-2	5-1393480-4	2-1392010-8	On Enquiry
37	2-1393480-4	4-1393480-3	3-1392010-5	3-1392010-6	On Enquiry

Socket without Boardlocks — Solder Termination

No of Ways	3mm Hole	4-40 Inserts	4-40 Screwlocks	M3 Inserts	M3 Screwlocks
9	1-1393480-7	3-1393480-6	4-1393480-7	2-1393480-8	On Enquiry
15	1-1393480-8	3-1393480-7	4-1393480-8	2-1393480-9	On Enquiry
25	1-1393480-9	3-1393480-8	4-1393480-9	3-1393480-0	On Enquiry
37	2-1393480-0	3-1393480-9	5-1393480-0	3-1392010-8	On Enquiry

Note: All part numbers are RoHS compliant.

Standard Density Press Fit Termination, Right-Angle Mounting — European Standard Footprint



Material and Finish:

Front Shell—Steel, tin plated
Housing—Black thermoplastic PBTP/PPS
Flammability—UL 94V-0
Contact Material—
Pin—Copper alloy
Socket—Copper alloy
Contact Area Plating—Nickel/Gold (>250 mating cycles)
Current Rating—2.2A
Insulation Resistance—5000 MΩ min.
Dielectric Strength—1000V AC
Temperature Rating—-55°C to +125°C

Plug with Boardlocks — Press Fit Termination

No of Ways	3mm Hole	4-40 Inserts	4-40 Screwlocks	M3 Inserts	M3 Screwlocks
9	—	3-1393481-2	3-1393481-8	2-1393481-5	On Enquiry
15	—	3-1393481-3	3-1393481-9	2-1393481-6	On Enquiry
25	—	3-1393481-4	2-1393497-7	2-1393481-7	On Enquiry
37	—	2-1392010-7	4-1393481-0	2-1393481-8	On Enquiry

Socket with Boardlocks — Press Fit Termination

No of Ways	3mm Hole	4-40 Inserts	4-40 Screwlocks	M3 Inserts	M3 Screwlocks
9	—	2-1393481-9	3-1393481-6	2-1393481-1	On Enquiry
15	—	3-1393481-0	2-1393497-4	2-1393481-2	On Enquiry
25	—	3-1393481-1	2-1393497-5	2-1393481-3	On Enquiry
37	—	2-1392010-6	2-1393497-6	2-1393481-4	On Enquiry

Standard Density Press Fit Termination, Right-Angle Mounting — Eurostyle Footprint



Material and Finish:

Front Shell—Steel, tin plated
Housing—Black thermoplastic PBTP/PPS
Flammability—UL 94V-0
Contact Material—
Pin—Copper alloy
Socket—Copper alloy
Contact Area Plating—Nickel/Gold (>250 mating cycles)
Current Rating—2.2A
Insulation Resistance—5000 MΩ min.
Dielectric Strength—1000V AC
Temperature Rating—-55°C to +125°C

Plug with Boardlocks — Press Fit Termination

No of Ways	3mm Hole	4-40 Inserts	4-40 Screwlocks	M3 Inserts	M3 Screwlocks
9	—	On Enquiry	3-1393482-0	1-1393482-4	2-1393482-1
15	—	On Enquiry	3-1393482-2	3-1393497-0	4-1483489-2
25	—	On Enquiry	3-1393482-4	1-1393482-5	On Enquiry
37	—	On Enquiry	3-1393482-5	3-1393497-1	On Enquiry

Socket with Boardlocks — Press Fit Termination

No of Ways	3mm Hole	4-40 Inserts	4-40 Screwlocks	M3 Inserts	M3 Screwlocks
9	—	1-1393482-6	2-1393482-2	1-1393482-2	2-1393482-0
15	—	1-1393482-8	2-1393482-4	1-1393482-3	On Enquiry
25	—	3-1392010-9	2-1393482-6	9-1393487-2	On Enquiry
37	—	4-1392010-0	2-1393482-8	2-1393497-9	On Enquiry

Note: All part numbers are RoHS compliant.

Компания «Life Electronics» занимается поставками электронных компонентов импортного и отечественного производства от производителей и со складов крупных дистрибьюторов Европы, Америки и Азии.

С конца 2013 года компания активно расширяет линейку поставок компонентов по направлению коаксиальный кабель, кварцевые генераторы и конденсаторы (керамические, пленочные, электролитические), за счёт заключения дистрибьюторских договоров

Мы предлагаем:

- Конкурентоспособные цены и скидки постоянным клиентам.
- Специальные условия для постоянных клиентов.
- Подбор аналогов.
- Поставку компонентов в любых объемах, удовлетворяющих вашим потребностям.
- Приемлемые сроки поставки, возможна ускоренная поставка.
- Доставку товара в любую точку России и стран СНГ.
- Комплексную поставку.
- Работу по проектам и поставку образцов.
- Формирование склада под заказчика.
- Сертификаты соответствия на поставляемую продукцию (по желанию клиента).
- Тестирование поставляемой продукции.
- Поставку компонентов, требующих военную и космическую приемку.
- Входной контроль качества.
- Наличие сертификата ISO.

В составе нашей компании организован Конструкторский отдел, призванный помогать разработчикам, и инженерам.

Конструкторский отдел помогает осуществить:

- Регистрацию проекта у производителя компонентов.
- Техническую поддержку проекта.
- Защиту от снятия компонента с производства.
- Оценку стоимости проекта по компонентам.
- Изготовление тестовой платы монтаж и пусконаладочные работы.



Тел: +7 (812) 336 43 04 (многоканальный)

Email: org@lifeelectronics.ru