

FEATURES

- 16-bit/14-bit ADC family**
- Dual simultaneous sampling**
- Fully differential analog inputs**
- 4 MSPS throughput conversion rate**
- SNR (typical)**
 - 92.5 dB, $V_{REF} = 3.3\text{ V}$ external at AD7380 (16-bit)
 - 85.4 dB, $V_{REF} = 3.3\text{ V}$ external at AD7381 (14-bit)
 - 101 dB with $\times 16$ OSR
- On-chip oversampling function**
- Resolution boost function**
- INL (maximum)**
 - 2.0 LSBs at 16-bit
 - 1.0 LSB at 14-bit
- 2.5 V internal reference**
- High speed serial interface**
- -40°C to $+125^{\circ}\text{C}$ operation**
- 16-lead LFCSP, $3\text{ mm} \times 3\text{ mm}$**
- Wide common-mode range**
- Alert function**

APPLICATIONS

- Motor control position feedback**
- Motor control current sense**
- Sonar**
- Power quality**
- Data acquisition systems**
- Erbium doped fiber amplifier (EDFA) applications**
- I and Q demodulation**

GENERAL DESCRIPTION

The AD7380/AD7381 are a 16-bit and 14-bit pin-compatible family of dual simultaneous sampling, high speed, low power, successive approximation register (SAR) analog-to-digital converters (ADCs) that operate from a 3.0 V to 3.6 V power supply and feature throughput rates up to 4 MSPS. The analog input type is differential, accepts a wide common-mode input voltage, and is sampled and converted on the falling edge of $\overline{\text{CS}}$.

An integrated on-chip oversampling block improves dynamic range and reduces noise at lower bandwidths. A buffered internal 2.5 V reference is included. Alternatively, an external reference up to 3.3 V can be used.

The conversion process and data acquisition use standard control inputs allowing simple interfacing to microprocessors or digital signal processors (DSPs). The device is compatible with 1.8 V, 2.5 V, and 3.3 V interfaces using the separate logic supply.

The AD7380/AD7381 are available in a 16-lead lead frame chip scale package (LFCSP) with operation specified from -40°C to $+125^{\circ}\text{C}$.

PRODUCT HIGHLIGHTS

1. Dual simultaneous sampling and conversion with two complete ADC functions.
2. Pin-compatible product family.
3. High 4 MSPS throughput rate.
4. Space saving $3\text{ mm} \times 3\text{ mm}$ LFCSP.
5. An integrated oversampling block to increase dynamic range, reduce noise, and reduce SCLK speed requirements.
6. Differential analog inputs with wide common-mode range.
7. Small sampling capacitor reduces amplifier drive burden.

FUNCTIONAL BLOCK DIAGRAM

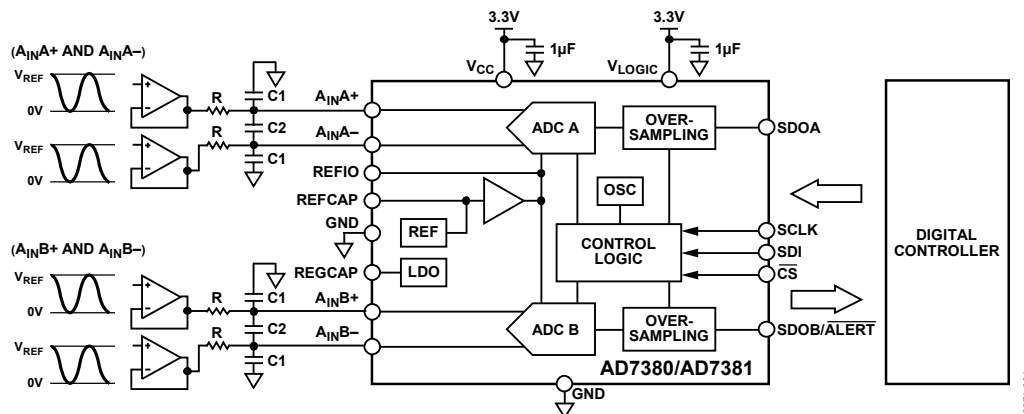

Figure 1.

Rev. A

Information furnished by Analog Devices is believed to be accurate and reliable. However, no responsibility is assumed by Analog Devices for its use, nor for any infringements of patents or other rights of third parties that may result from its use. Specifications subject to change without notice. No license is granted by implication or otherwise under any patent or patent rights of Analog Devices. Trademarks and registered trademarks are the property of their respective owners.

Document Feedback

TABLE OF CONTENTS

| | | | |
|--|----|--------------------------------------|----|
| Features | 1 | Resolution Boost | 20 |
| Applications..... | 1 | Alert | 20 |
| General Description | 1 | Power Modes..... | 21 |
| Product Highlights | 1 | Internal and External Reference..... | 21 |
| Functional Block Diagram | 1 | Software Reset..... | 21 |
| Revision History | 2 | Diagnostic Self Test | 21 |
| Specifications..... | 3 | Interface | 22 |
| Timing Specifications | 6 | Reading Conversion Results | 22 |
| Absolute Maximum Ratings..... | 8 | Low Latency Readback..... | 23 |
| Thermal Resistance | 8 | Reading from Device Registers | 24 |
| ESD Caution..... | 8 | Writing to Device Registers | 24 |
| Pin Configuration and Function Descriptions..... | 9 | CRC..... | 25 |
| Typical Performance Characteristics | 10 | Registers..... | 27 |
| Terminology | 13 | Addressing Registers..... | 27 |
| Theory of Operation | 14 | CONFIGURATION1 Register | 28 |
| Circuit Information..... | 14 | CONFIGURATION2 Register | 29 |
| Converter Operation..... | 14 | ALERT Register | 29 |
| Analog Input Structure..... | 14 | ALERT_LOW_THRESHOLD Register | 30 |
| ADC Transfer Function..... | 15 | ALERT_HIGH_THRESHOLD Register..... | 30 |
| Applications Information | 16 | Outline Dimensions | 31 |
| Power Supply..... | 16 | Ordering Guide | 31 |
| Modes of Operation | 18 | | |
| Oversampling..... | 18 | | |

REVISION HISTORY

11/2019—Rev. 0 to Rev. A

| | | | |
|---|----|--|----|
| Updated Title..... | 1 | Changes to Normal Average Oversampling Section, Table 10, and Figure 32 | 18 |
| Changes to Features Section, Applications Section, and Figure 1 | 1 | Changes to Rolling Average Oversampling Section and Figure 33..... | 19 |
| Changes to Table 1..... | 3 | Changes to Resolution Boost Section..... | 20 |
| Changes to Table 2..... | 4 | Added Figure 36; Renumbered Sequentially | 21 |
| Changes to Aperture Delay Match Parameter, Table 3 and V _{REF} Noise Parameter, Table 3 | 5 | Change to Figure 37 and Table 12..... | 22 |
| Changes to Table 4..... | 6 | Changes to Serial 2-Wire Mode Section, Resolution Boost Mode Section, Figure 38, and Figure 40..... | 23 |
| Change to Thermal Resistance Section | 8 | Changes to Figure 41 and Figure 42..... | 24 |
| Change to Pin 9 Description, Table 7 | 9 | Changes to Figure 43..... | 26 |
| Changes to Figure 11 Caption..... | 10 | Changes to Table 14 and Table 16 | 27 |
| Changes to Figure 15 Caption, Figure 18, Figure 19, and Figure 20..... | 11 | Change to CONFIGURATION1 Register Section and Table 17 | 28 |
| Changes to Terminology Section..... | 13 | Change to CONFIGURATION2 Register Section and ALERT Register Section..... | 29 |
| Change to ADC Transfer Function Section..... | 15 | Changes to ALERT_LOW_THRESHOLD Register Section, Table 20, ALERT_HIGH_THRESHOLD Register Section, and Table 21 | 30 |
| Changes to Applications Information Section and Power Supply Section..... | 16 | Changes to Ordering Guide | 31 |
| Added Table 9; Renumbered Sequentially | 16 | | |
| Changes to Figure 31..... | 17 | | |

1/2019—Revision 0: Initial Version

SPECIFICATIONS

$V_{CC} = 3.0\text{ V to }3.6\text{ V}$, $V_{LOGIC} = 1.65\text{ V to }3.6\text{ V}$, reference voltage (V_{REF}) = 2.5 V internal, sampling frequency (f_{SAMPLE}) = 4 MSPS, and $T_A = -40^\circ\text{C to }+125^\circ\text{C}$, no oversampling enabled, unless otherwise noted.

Table 1. AD7380

| Parameter | Test Conditions/Comments | Min | Typ | Max | Unit |
|--|---|--------|--------|--------|-------------------|
| RESOLUTION | | 16 | | | Bit |
| THROUGHPUT | | | | | |
| Conversion Rate | | | | 4 | MSPS |
| DC ACCURACY | | | | | |
| No Missing Codes | | 16 | | | Bits |
| Differential Nonlinearity (DNL) Error | | -1.0 | ±0.7 | +1.0 | LSB |
| Integral Nonlinearity (INL) Error | | -2.0 | ±0.75 | +2.0 | LSB |
| Gain Error | | -0.015 | ±0.002 | +0.015 | % FS ¹ |
| Gain Error Temperature Drift | | -11 | ±1 | +11 | ppm/°C |
| Gain Error Match | | -0.01 | ±0.002 | +0.01 | % FS |
| Zero Error | At 25°C, $V_{CC} = 3.3\text{ V}$ | -0.2 | ±0.01 | +0.2 | mV |
| | | -0.5 | | +0.5 | mV |
| Zero Error Drift | | -2 | ±0.5 | +2 | μV/°C |
| Zero Error Matching | | -0.5 | ±0.1 | +0.5 | mV |
| AC ACCURACY | | | | | |
| Dynamic Range | Input frequency (f_{IN}) = 1 kHz $V_{REF} = 3.3\text{ V external}$ | | 93.3 | | dB |
| | | | 91.8 | | dB |
| Oversampled Dynamic Range | Oversampling ratio (OSR) = 4 | | 95.2 | | dB |
| Signal-to-Noise Ratio (SNR) | $V_{REF} = 3.3\text{ V external}$ | 90 | 92.5 | | dB |
| | | 88.5 | 91.1 | | dB |
| | OSR = 8, RES = 1 | | 98 | | dB |
| | OSR = 16, RES = 1 | | 101 | | dB |
| | $f_{IN} = 100\text{ kHz}$ | | 89 | | dB |
| Spurious-Free Dynamic Range (SFDR) | | | -110 | | dB |
| Total Harmonic Distortion (THD) | | | -113 | | dB |
| | $f_{IN} = 100\text{ kHz}$ | | -104 | | dB |
| Signal-to-(Noise + Distortion) (SINAD) | $V_{REF} = 3.3\text{ V external}$ | 89.5 | 92.3 | | dB |
| | | 88 | 91 | | dB |
| Channel to Channel Isolation | | | -110 | | dB |
| POWER SUPPLIES | | | | | |
| V_{CC} Current (I_{VCC}) | | | | | |
| Normal Mode (Operational) | | | 21.5 | 26 | mA |
| Power Dissipation | | | | | |
| Total Power (P_{TOTAL}) | | | 83 | 107 | mW |
| V_{CC} Power (P_{VCC}) | | | | | |
| Normal Mode (Operational) | | | 71 | 94 | mW |

¹ These specifications include full temperature range variation, but these specifications do not include the error contribution from the external reference.

$V_{CC} = 3.0\text{ V}$ to 3.6 V , $V_{LOGIC} = 1.65\text{ V}$ to 3.6 V , $V_{REF} = 2.5\text{ V}$ internal, $f_{SAMPLE} = 4\text{ MSPS}$, and $T_A = -40^\circ\text{C}$ to $+125^\circ\text{C}$, no oversampling enabled, unless otherwise noted.

Table 2. AD7381

| Parameter | Test Conditions/Comments | Min | Typ | Max | Unit |
|-------------------------------|-----------------------------------|-------|-------------|-------|------------------------------|
| RESOLUTION | | 14 | | | Bit |
| THROUGHPUT Conversion Rate | | | | 4 | MSPS |
| DC ACCURACY | | | | | |
| No Missing Codes | | 14 | | | Bits |
| DNL Error | | -1.0 | ± 0.5 | +1.0 | LSB |
| INL Error | | -1.0 | ± 0.3 | +1.0 | LSB |
| Gain Error | | -0.02 | ± 0.002 | +0.02 | % FS ¹ |
| Gain Error Temperature Drift | | -20 | ± 1 | +20 | ppm/ $^\circ\text{C}$ |
| Gain Error Match | | -0.02 | ± 0.002 | +0.02 | % FS |
| Zero Error | | -2 | ± 0.25 | +2 | LSB |
| Zero Error Drift | | +3 | ± 0.5 | +3 | $\mu\text{V}/^\circ\text{C}$ |
| Zero Error Matching | | -1.5 | ± 0.25 | +1.5 | LSB |
| AC ACCURACY | | | | | |
| Dynamic Range | $f_{IN} = 1\text{ kHz}$ | | 85.4 | | dB |
| Oversampled Dynamic Range | OSR = 4 | | 87 | | dB |
| SNR | $V_{REF} = 3.3\text{ V}$ external | 85 | 85.4 | | dB |
| | | 84.5 | 85 | | dB |
| | OSR = 8, RES = 1 | | 92.6 | | dB |
| | OSR = 16, RES = 1 | | 94.5 | | dB |
| | $f_{IN} = 100\text{ kHz}$ | | 84.6 | | dB |
| SFDR | $V_{REF} = 3.3\text{ V}$ | | -108 | | dB |
| | | | -112 | | dB |
| THD | $V_{REF} = 3.3\text{ V}$ | | -107 | | dB |
| | | | -112 | | dB |
| | $f_{IN} = 100\text{ kHz}$ | | -101 | | dB |
| SINAD | | 84.5 | 85.3 | | dB |
| | | 84 | 84.9 | | dB |
| Channel to Channel Isolation | | | -110 | | dB |
| POWER SUPPLIES | | | | | |
| I_{VCC} | | | | | |
| Normal Mode (Operational) | | | 21.5 | 26 | mA |
| Power Dissipation | | | | | |
| P_{TOTAL} | | | 83 | 107 | mW |
| P_{VCC} | | | | | |
| Normal Mode (Operational) | | | 71 | 94 | mW |

¹ These specifications include full temperature range variation, but these specifications do not include the error contribution from the external reference.

Table 3. All Devices

| Parameter | Test Conditions/Comments | Min | Typ | Max | Unit |
|--|--|------------------------|---------------------------|------------------------|-------------------------|
| ANALOG INPUT | | | | | |
| Voltage Range | $(A_{INX+}) - (A_{INX-})$ | $-V_{REF}$ | | $+V_{REF}$ | V |
| Absolute Input Voltage | A_{INX+}, A_{INX-} | -0.1 | | $V_{REF} + 0.1$ | V |
| Common-Mode Input Range | A_{INX+}, A_{INX-} | | 0.2 to $V_{REF} - 0.2$ | | V |
| Analog Input Common-Mode Rejection Ratio (CMRR) | $f_{IN} = 500$ kHz | | -75 | | dB |
| DC Leakage Current | | | 0.1 | 1 | μ A |
| Input Capacitance | When in track mode | | 18 | | pF |
| | When in hold mode | | 5 | | pF |
| SAMPLING DYNAMICS | | | | | |
| Input Bandwidth | At -0.1 dB | | 6 | | MHz |
| | At -3 dB | | 25 | | MHz |
| Aperture Delay | | | 2 | | ns |
| Aperture Delay Match | | | 26 | 100 | ps |
| Aperture Jitter | | | 20 | | ps |
| REFERENCE INPUT AND OUTPUT | | | | | |
| V_{REF} Input Voltage Range | External reference | 2.49 | | 3.4 | V |
| V_{REF} Input Current | External reference | | 0.47 | 0.51 | mA |
| V_{REF} Output Voltage | At 25°C | 2.498 | 2.5 | 2.502 | V |
| | -40°C to $+125^{\circ}\text{C}$ | 2.495 | | 2.505 | V |
| V_{REF} Temperature Coefficient | | | 1 | 10 | ppm/ $^{\circ}\text{C}$ |
| V_{REF} Line Regulation | | | -38 | | ppm/V |
| V_{REF} Load Regulation | | | -106 | | ppm/mA |
| V_{REF} Noise | | | 7 | | μ V rms |
| DIGITAL INPUTS (SCLK, SDI, $\overline{\text{CS}}$) | | | | | |
| Logic Levels | | | | | |
| Input Low Voltage (V_{IL}) | | | | $0.2 \times V_{LOGIC}$ | V |
| Input High Voltage (V_{IH}) | | $0.8 \times V_{LOGIC}$ | | | V |
| Input Low Current (I_{IL}) | | -1 | | $+1$ | μ A |
| Input High Current (I_{IH}) | | -1 | | $+1$ | μ A |
| DIGITAL OUTPUTS (SDOA, SDOB/ALERT) | | | | | |
| Output Coding | | | Twos complement | | Bits |
| Output Low Voltage (V_{OL}) | Sink current (I_{SINK}) = $+300$ μ A | | | 0.4 | V |
| Output High Voltage (V_{OH}) | Source current (I_{SOURCE}) = -300 μ A | $V_{LOGIC} - 0.3$ | | | V |
| Floating State Leakage Current | | | | ± 1 | μ A |
| Floating State Output Capacitance | | | 10 | | pF |
| POWER SUPPLIES | | | | | |
| V_{CC} | | 3.0 | 3.3 | 3.6 | V |
| | External reference = 3.3 V | 3.2 | 3.3 | 3.6 | V |
| V_{LOGIC} | | 1.65 | | 3.6 | V |
| I_{VCC} | | | | | |
| Normal Mode (Static) | | | 2.3 | 2.8 | mA |
| Shutdown Mode | | | 100 | 200 | μ A |
| V_{LOGIC} Current (I_{VLOGIC}) | SDOA and SDOB at $0x1FFF$ | | | | |
| Normal Mode (Static) | | | 10 | 200 | nA |
| Normal Mode (Operational) | | | 3.5 | 3.7 | mA |
| Shutdown Mode | | | 10 | 200 | nA |

| Parameter | Test Conditions/Comments | Min | Typ | Max | Unit |
|---------------------------|--------------------------|-----|------|------|---------|
| Power Dissipation | | | | | |
| P_{VCC} | | | | | |
| Normal Mode (Static) | | | 7.6 | 10 | mW |
| Shutdown Mode | | | 330 | 720 | μ W |
| P_{VLOGIC} | SDOA and SDOB at 0x1FFF | | | | |
| Normal Mode (Static) | | | 33 | 720 | nW |
| Normal Mode (Operational) | | | 11.5 | 13.3 | mW |
| Shutdown Mode | | | 33 | 720 | nW |

TIMING SPECIFICATIONS

$V_{CC} = 3.0\text{ V}$ to 3.6 V , $V_{LOGIC} = 1.65\text{ V}$ to 3.6 V , $V_{REF} = 2.5\text{ V}$ internal, and $T_A = -40^\circ\text{C}$ to $+125^\circ\text{C}$, unless otherwise noted.

Table 4.^{1,2}

| Parameter | Min | Typ | Max | Unit | Description |
|-------------------|---------------------------------------|-----|-----|---------|--|
| t_{CYC} | 250 | | | ns | Time between conversions |
| t_{SCLKED} | 0.4 | | | ns | \overline{CS} falling edge to first SCLK falling edge |
| t_{SCLK} | 12.5 | | | ns | SCLK period |
| t_{SCLKH} | 5 | | | ns | SCLK high time |
| t_{SCLKL} | 5 | | | ns | SCLK low time |
| t_{CSH} | 10 | | | ns | \overline{CS} pulse width |
| t_{QUIET} | 10 | | | ns | Interface quiet time prior to conversion |
| t_{SDOEN} | | | | | \overline{CS} low to SDOA and SDOB/ALERT enabled |
| | | | 5.5 | ns | $V_{LOGIC} \geq 2.25\text{ V}$ |
| | | | 8 | ns | $1.65\text{ V} \leq V_{LOGIC} < 2.25\text{ V}$ |
| t_{SDOH} | 2 | | | ns | SCLK rising edge to SDOA and the SDOB/ALERT hold time |
| t_{SDOS} | | | | | SCLK rising edge to SDOA and the SDOB/ALERT setup time |
| | | | 5.5 | ns | $V_{LOGIC} \geq 2.25\text{ V}$ |
| | | | 8 | ns | $1.65\text{ V} \leq V_{LOGIC} < 2.25\text{ V}$ |
| t_{SDOT} | | | 45 | ns | \overline{CS} rising edge to SDOA and the SDOB/ALERT high impedance |
| t_{SDIS} | 1 | | | ns | SDI setup time prior to SCLK falling edge |
| t_{SDIH} | 1 | | | ns | SDI hold time after SCLK falling edge |
| t_{SCLKCS} | 0 | | | ns | SCLK rising edge to \overline{CS} rising edge |
| $t_{CONVERT}$ | | | 190 | ns | Conversion time |
| $t_{ACQUIRE}$ | 110 | | | ns | Acquire time |
| t_{RESET} | | | | | Valid time to start conversion after software reset (see Figure 36) |
| | | 250 | | ns | Valid time to start conversion after soft reset |
| | | 800 | | ns | Valid time to start conversion after hard reset |
| $t_{POWERUP}$ | | | | | Supply active to conversion |
| | | | 5 | ms | First conversion allowed |
| | | | 11 | ms | Settled to within 1% with internal reference |
| | | | 5 | ms | Settled to within 1% with external reference |
| $t_{REGWRITE}$ | | | 5 | ms | Supply active to register read write access allowed |
| $t_{STARTUP}$ | | | | | Exiting power-down mode to conversion |
| | | | 11 | ms | Settled to within 1% with internal reference |
| | | | 10 | μ s | Settled to within 1% with external reference |
| $t_{CONVERT0}^2$ | 4 | 7 | 10 | ns | Conversion start time for first sample in oversampling (OS) normal mode |
| $t_{CONVERTx}$ | | | | | Conversion start time for x^{th} sample in OS normal mode |
| | $t_{CONVERT0} + (320 \times (x - 1))$ | | | ns | For AD7380 at 3 MSPS |
| | $t_{CONVERT0} + (250 \times (x - 1))$ | | | ns | For AD7381 at 4 MSPS |
| t_{ALERTS} | | | 200 | ns | Time from \overline{CS} to \overline{ALERT} indication (see Figure 34) |
| t_{ALERTC} | | | 12 | ns | Time from \overline{CS} to \overline{ALERT} clear (see Figure 34) |
| t_{ALERTS_NOS} | | | 12 | ns | Time from internal conversion with exceeded threshold to \overline{ALERT} indication (see Figure 34) |

¹ All specifications are 10 pF load.

² Guaranteed by design.

ABSOLUTE MAXIMUM RATINGS

Table 5.

| Parameter | Rating |
|--|--|
| V _{CC} to Ground (GND) | −0.3 V to +4 V |
| V _{LOGIC} to GND | −0.3 V to +4 V |
| Analog Input Voltage to GND | −0.3 V to V _{REF} +0.3 V, V _{CC} + 0.3 V, 4 V |
| Digital Input Voltage to GND | −0.3 V to V _{LOGIC} + 0.3 V, 4 V |
| Digital Output Voltage to GND | −0.3 V to V _{LOGIC} + 0.3 V, 4 V |
| Reference Input and Output (REFIO) Input to GND | −0.3 V to V _{CC} + 0.3 V, 4 V |
| Input Current to Any Pin Except Supplies | ±10 mA |
| Operating Temperature Range | −40°C to +125°C |
| Storage Temperature Range | −65°C to +150°C |
| Junction Temperature | 150°C |
| Pb-Free Soldering Reflow Temperature | 260°C |
| Electrostatic Discharge (ESD) Ratings | |
| Human Body Model (HBM) | 4 kV |
| Field Induced Charge Device Model (FICDM) | 1.25 kV |

Stresses at or above those listed under Absolute Maximum Ratings may cause permanent damage to the product. This is a stress rating only; functional operation of the product at these or any other conditions above those indicated in the operational section of this specification is not implied. Operation beyond the maximum operating conditions for extended periods may affect product reliability.

THERMAL RESISTANCE

Thermal performance is directly linked to printed circuit board (PCB) design and operating environment. Careful attention to PCB thermal design is required.

θ_{JA} is the natural convection junction to ambient thermal resistance measured in a one cubic foot sealed enclosure. θ_{JC} is the junction to case thermal resistance.

Table 6. Thermal Resistance

| Package Type | θ_{JA} | θ_{JC} | Unit |
|-----------------------|---------------|---------------|------|
| CP-16-45 ¹ | 55.4 | 12.7 | °C/W |

¹ Test Condition 1: thermal impedance simulated values are based on JEDEC 2S2P thermal test board four thermal vias. See JEDEC JESD-51.

ESD CAUTION



ESD (electrostatic discharge) sensitive device. Charged devices and circuit boards can discharge without detection. Although this product features patented or proprietary protection circuitry, damage may occur on devices subjected to high energy ESD. Therefore, proper ESD precautions should be taken to avoid performance degradation or loss of functionality.

PIN CONFIGURATION AND FUNCTION DESCRIPTIONS

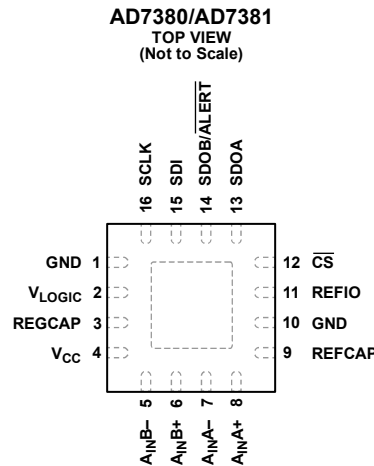

NOTES

1. EXPOSED PAD. FOR CORRECT OPERATION OF THE DEVICE, THE EXPOSED PAD MUST BE CONNECTED TO GROUND.

16871-008

Figure 8. Pin Configuration

Table 7. Pin Function Descriptions

| Pin No. | Mnemonic | Description |
|---------|---------------------------------------|--|
| 1, 10 | GND | Ground Reference Point. This pin is the ground reference point for all circuitry on the device. |
| 2 | V _{LOGIC} | Logic Interface Supply Voltage, 1.65 V to 3.6 V. Decouple this pin to GND with a 1 μ F capacitor. |
| 3 | REGCAP | Decoupling Capacitor Pin for Voltage Output from Internal Regulator. Decouple this pin to GND with a 1 μ F capacitor. The voltage at this pin is 1.9 V typical. |
| 4 | V _{CC} | Power Supply Input Voltage, 3.0 V to 3.6 V. Decouple this pin to GND using a 1 μ F capacitor. |
| 5, 6 | A _{INB-} , A _{INB+} | Analog Inputs of ADC B. These analog inputs form a differential pair. |
| 7, 8 | A _{INA-} , A _{INA+} | Analog Inputs of ADC A. These analog inputs form a differential pair. |
| 9 | REFCAP | Decoupling Capacitor Pin for Band Gap Reference. Decouple this pin to GND with a 0.1 μ F capacitor. The voltage at this pin is 2.5 V typical. |
| 11 | REFIO | Reference Input and Output. The on-chip reference of 2.5 V is available as an output on this pin for external use if the device is configured accordingly. Alternatively, an external reference of 2.5 V to 3.3 V can be input to this pin. Decoupling is required on this pin for both the internal and external reference options. A 1 μ F capacitor must be applied from this pin to GND. |
| 12 | $\overline{\text{CS}}$ | Chip Select Input. Active low, logic input. This input provides the dual function of initiating conversions on the AD7380 and the AD7381 and framing the serial data transfer. |
| 13 | SDOA | Serial Data Output A. This pin functions as a serial data output pin to access the ADC A or ADC B conversion results or data from any of the on-chip registers. |
| 14 | SDOB/ $\overline{\text{ALERT}}$ | Serial Data Output B/Alert Indication Output. This pin can operate as a serial data output pin or alert indication output. SDOB. This pin functions as a serial data output pin to access the ADC B conversion results. $\overline{\text{ALERT}}$. This pin operates as an alert pin going low to indicate that a conversion result has exceeded a configured threshold. |
| 15 | SDI | Serial Data Input. This input provides the data written to the on-chip control registers. |
| 16 | SCLK | Serial Clock Input. This serial clock input is for data transfers to and from the ADC. |
| | EPAD | Exposed Pad. For correct operation of the device, the exposed pad must be connected to ground. |

TYPICAL PERFORMANCE CHARACTERISTICS

$V_{REF} = 2.5\text{ V}$ internal, $V_{CC} = 3.6\text{ V}$, $V_{LOGIC} = 3.3\text{ V}$, $f_{SAMPLE} = 4\text{ MSPS}$, $f_{IN} = 1\text{ kHz}$, and $T_A = 25^\circ\text{C}$, unless otherwise noted.

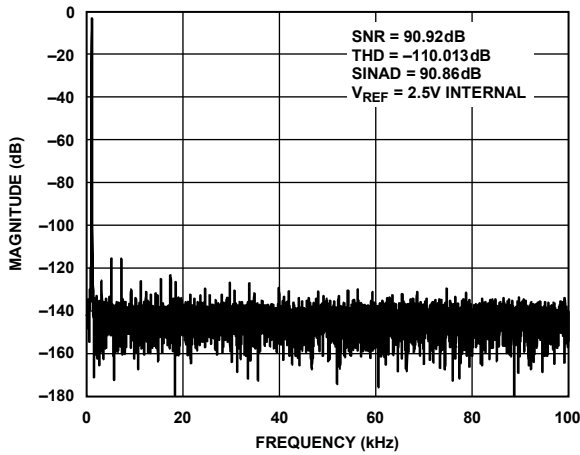

Figure 9. Fast Fourier Transform (FFT), $V_{REF} = 2.5\text{ V}$ Internal

16871-109

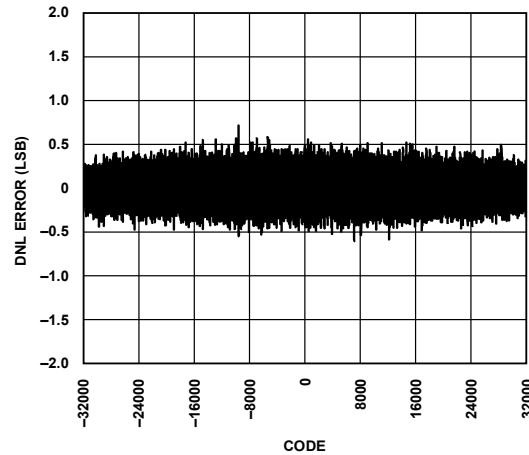

Figure 12. Typical DNL Error

16871-112

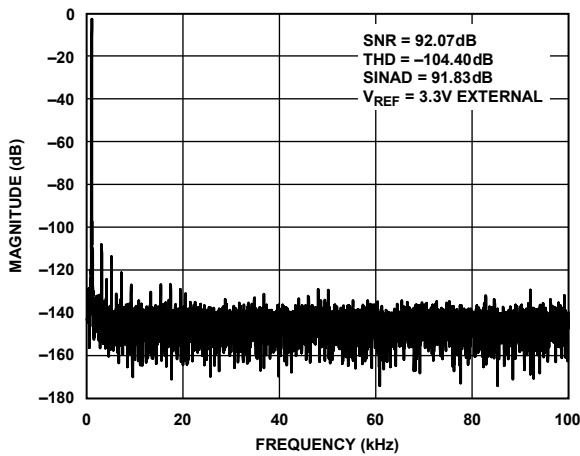

Figure 10. FFT, $V_{REF} = 3.3\text{ V}$ External

16871-110

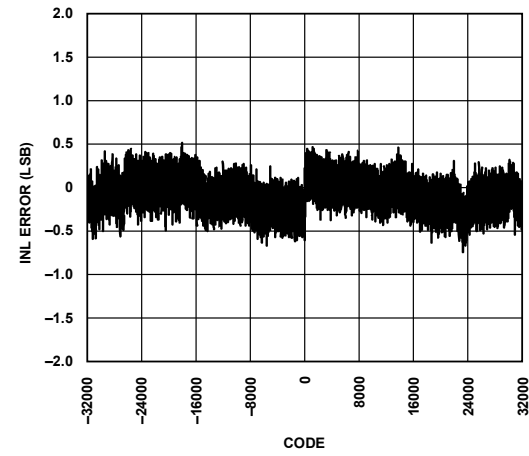

Figure 13. Typical INL Error

16871-113

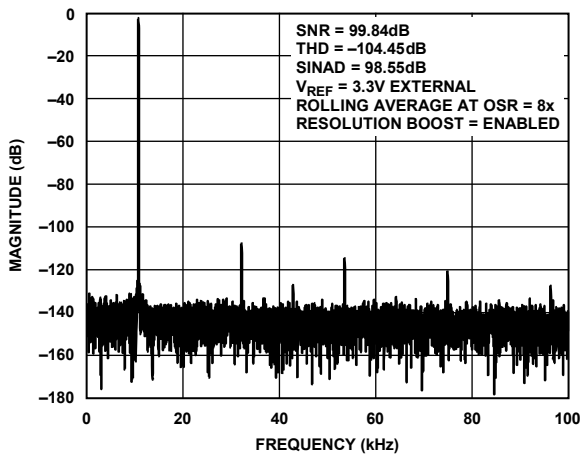

Figure 11. FFT with Oversampling, $V_{REF} = 3.3\text{ V}$ External

16871-111

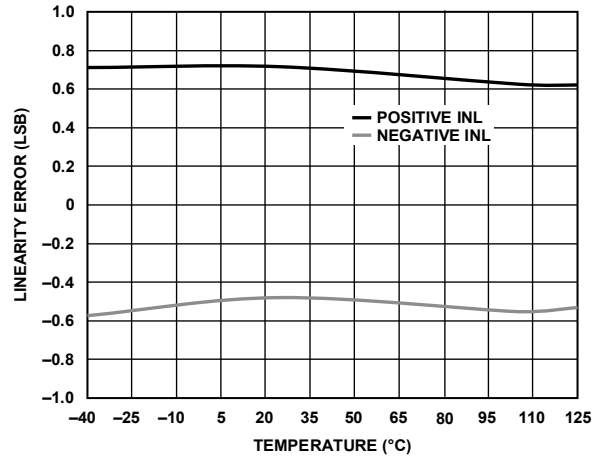

Figure 14. Linearity Error vs. Temperature

16871-114

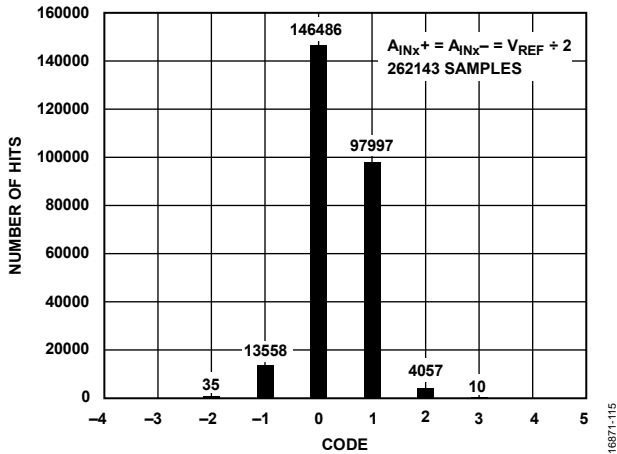

Figure 15. DC Histogram Codes at Code Center

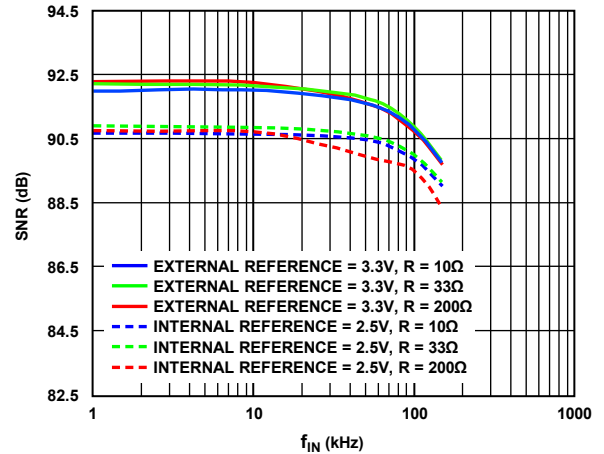

Figure 18. SNR vs. f_{IN} (R Means Resistance)

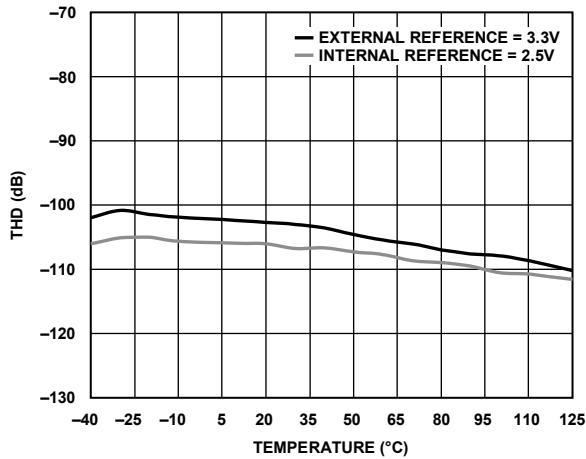

Figure 16. THD vs. Temperature

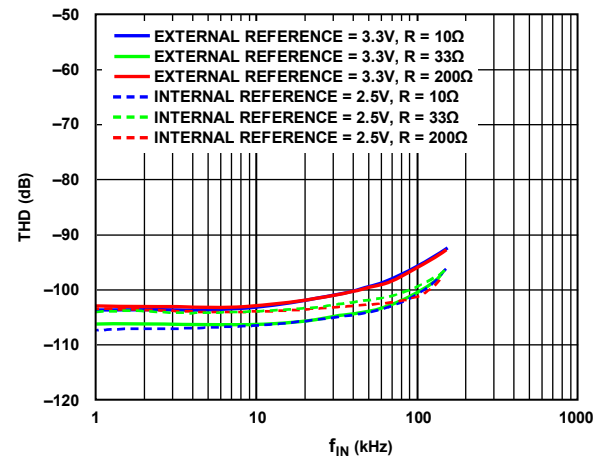

Figure 19. THD vs. f_{IN}

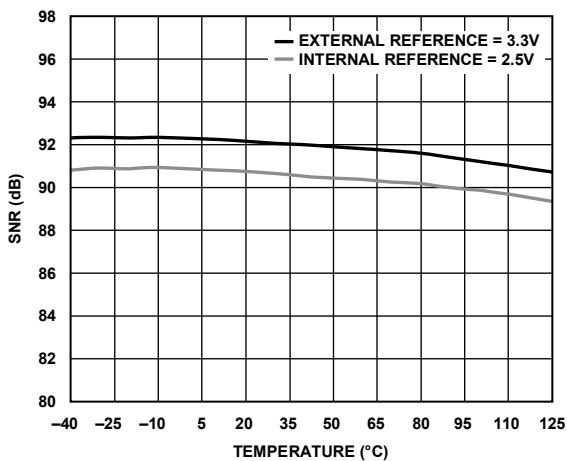

Figure 17. SNR vs. Temperature

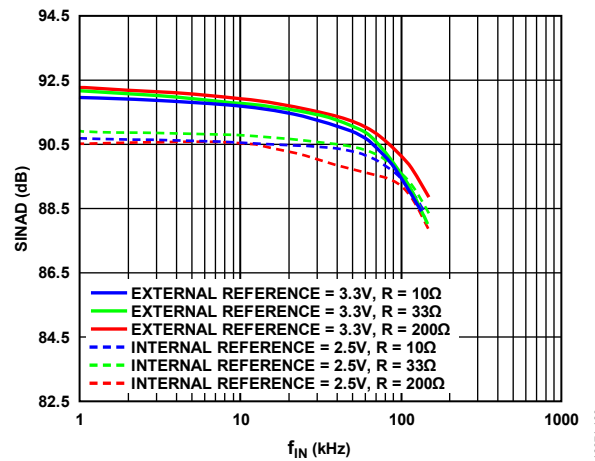

Figure 20. SINAD vs. f_{IN}

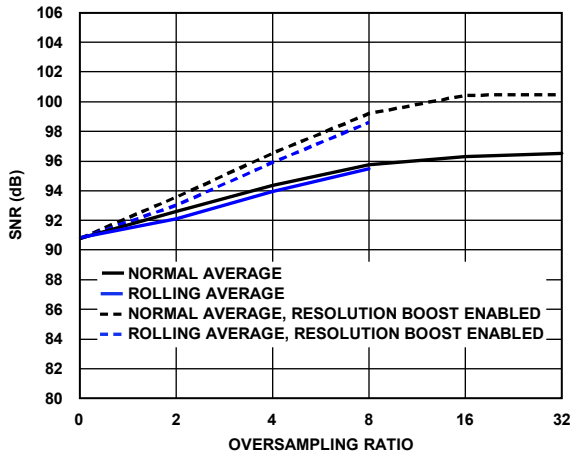

Figure 21. SNR vs. Oversampling Ratio

16871-121

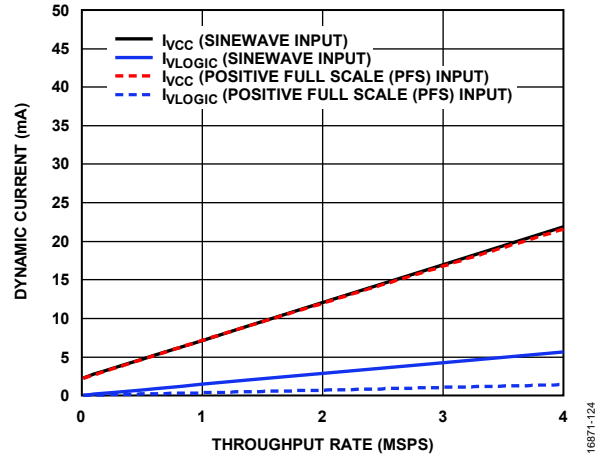

Figure 24. Dynamic Current at Different Input Signal vs. Throughput Rate

16871-124

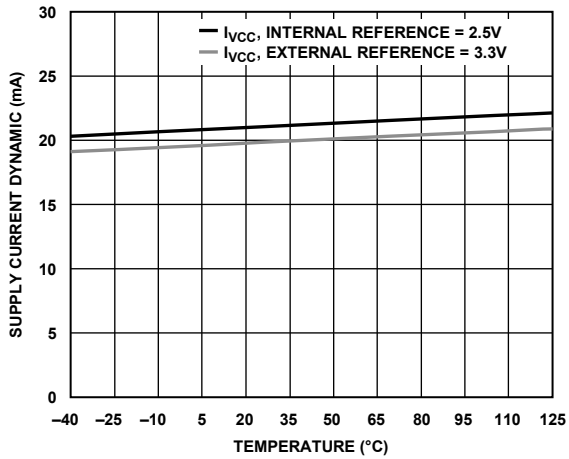

Figure 22. Supply Current Dynamic vs. Temperature

16871-122

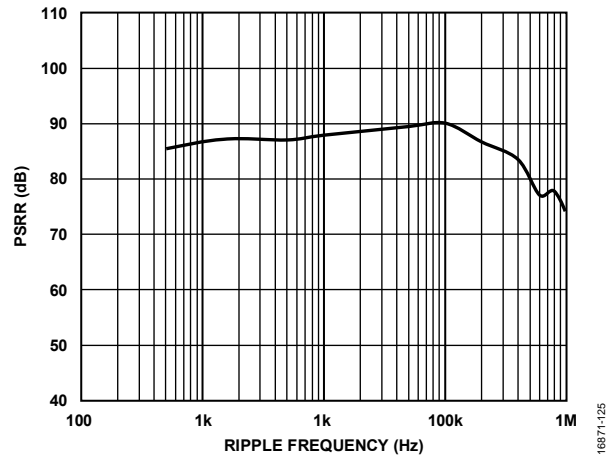

Figure 25. Power Supply Rejection Ratio (PSRR) vs. Ripple Frequency

16871-125

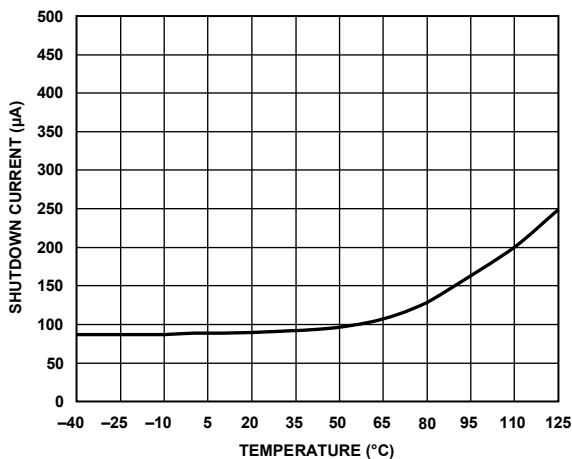

Figure 23. Shutdown Current vs. Temperature

16871-123

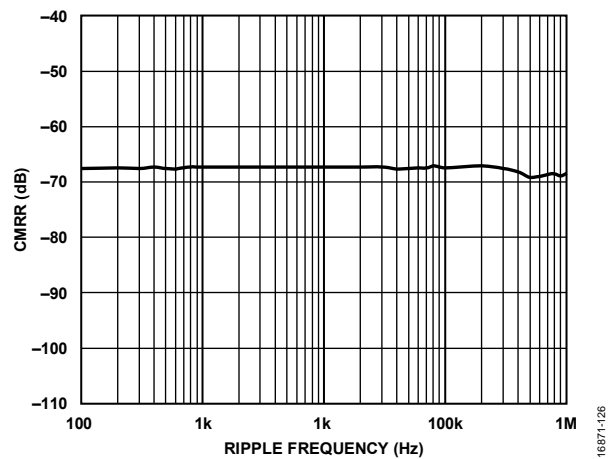

Figure 26. CMRR vs. Ripple Frequency

16871-126

TERMINOLOGY

Differential Nonlinearity (DNL)

In an ideal ADC, code transitions are 1 LSB apart. DNL is the maximum deviation from this ideal value. DNL is often specified in terms of resolution for which no missing codes are guaranteed.

Integral Nonlinearity (INL)

INL is the deviation of each individual code from a line drawn from negative full scale through positive full scale. The point used as negative full scale occurs ½ LSB before the first code transition. Positive full scale is defined as a level 1½ LSB beyond the last code transition. The deviation is measured from the middle of each code to the true straight line.

Gain Error

The first transition (from 100 ... 000 to 100 ... 001) occurs at a level ½ LSB above nominal negative full scale. The last transition (from 011 ... 110 to 011 ... 111) occurs for an analog voltage 1½ LSB below the nominal full scale. The gain error is the deviation of the difference between the actual level of the last transition and the actual level of the first transition from the difference between the ideal levels.

Gain Error Temperature Drift

The gain error drift is the gain error change due to a temperature change of 1°C.

Gain Error Match

Gain error match is the difference in negative full-scale error between the input channels and the difference in positive full-scale error between the input channels.

Zero Error

Zero error is the difference between the ideal midscale voltage, 0 V, and the actual voltage producing the midscale output code, 0 LSB.

Zero Error Drift

The zero error drift is the zero error change due to a temperature change of 1°C.

Zero Error Matching

Zero error matching is the difference in zero error between the input channels.

Signal-to-Noise Ratio (SNR)

SNR is the ratio of the rms value of the actual input signal to the rms sum of all other spectral components below the Nyquist frequency, excluding harmonics and dc. The value for SNR is expressed in decibels (dB).

Spurious-Free Dynamic Range (SFDR)

SFDR is the difference, in dB, between the rms amplitude of the input signal and the peak spurious signal.

Total Harmonic Distortion (THD)

THD is the ratio of the rms sum of the first five harmonic components to the rms value of a full-scale input signal and is expressed in dB.

Signal-to-(Noise + Distortion) (SINAD)

SINAD is the ratio of the rms value of the actual input signal to the rms sum of all other spectral components that are less than the Nyquist frequency, including harmonics but excluding dc. The value for SINAD is expressed in dB.

Analog Input Common-Mode Rejection Ratio (CMRR)

CMRR is the ratio of the power in the ADC output at the frequency, f , to the power of a 200 mV p-p sine wave applied to the common-mode voltage of A_{INX+} and A_{INX-} of frequency, f .

$$CMRR (dB) = 10 \log(P_{ADC_IN}/P_{ADC_OUT})$$

where:

P_{ADC_IN} is the common-mode power at the frequency, f , applied to the A_{INX+} and A_{INX-} inputs.

P_{ADC_OUT} is the power at the frequency, f , in the ADC output.

Aperture Delay

Aperture delay is the measure of the acquisition performance and is the time between the falling edge of the CS input and when the input signal is held for a conversion.

Aperture Delay Match

Aperture delay match is the difference of the aperture delay between ADC A and ADC B.

Aperture Jitter

Aperture jitter is the variation in aperture delay.

THEORY OF OPERATION

CIRCUIT INFORMATION

The AD7380/AD7381 are high speed, dual simultaneous sampling, fully differential 16-bit/14-bit, SAR ADCs. The AD7380/AD7381 operate from a 3.0 V to 3.6 V power supply and feature throughput rates up to 4 MSPS.

The AD7380/AD7381 contain two SAR ADCs and a serial interface with two separate data output pins. The device is housed in a 16-lead LFCSP, offering the user considerable space-saving advantages over alternative solutions.

Data is accessed from the device via the serial interface. The interface can operate with two or one serial outputs. The AD7380/AD7381 have an on-chip 2.5 V internal V_{REF} . If an external reference is desired, the internal reference can be disabled, and a reference value ranging from 2.5 V to 3.3 V can be supplied. If the internal reference is used elsewhere in the system, buffer the reference output. The differential analog input range for the AD7380/AD7381 is the common-mode voltage (V_{CM}) \pm $V_{REF}/2$.

The AD7380/AD7381 feature an on-chip oversampling block to improve performance. Normal average and rolling average oversampling modes and power-down options that allow power saving between conversions are also available. Configuration of the device is implemented via the standard SPI (see the Interface section).

CONVERTER OPERATION

The AD7380/AD7381 have two SAR ADCs, each based around two capacitive digital-to-analog converters (DACs). Figure 27 and Figure 28 show simplified schematics of one of the ADCs in acquisition and conversion phases, respectively. The ADC comprises control logic, an SAR, and two capacitive DACs. In Figure 27 (the acquisition phase), SW3 is closed, SW1 and SW2 are in Position A, the comparator is held in a balanced condition, and the sampling capacitor (C_s) arrays can acquire the differential signal on the input.

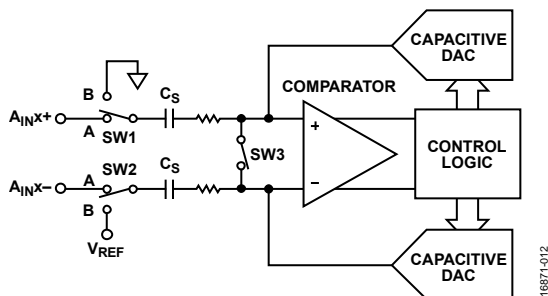

Figure 27. ADC Acquisition Phase

When the ADC starts a conversion (see Figure 28), SW3 opens and SW1 and SW2 move to Position B, causing the comparator to become unbalanced. Both inputs are disconnected when the conversion begins. The control logic and charge redistribution

DACs are used to add and subtract fixed amounts of charge from the sampling capacitor arrays to bring the comparator back into a balanced condition. When the comparator is rebalanced, the conversion is complete. The control logic generates the ADC output code. The output impedances of the sources driving the A_{INX+} and A_{INX-} pins must be matched. Otherwise, the two inputs have different settling times, resulting in errors.

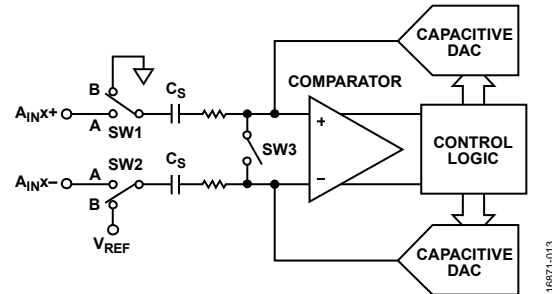

Figure 28. ADC Conversion Phase

ANALOG INPUT STRUCTURE

Figure 29 shows the equivalent circuit of the analog input structure of the AD7380/AD7381. The four diodes provide ESD protection for the analog inputs. Ensure that the analog input signals never exceed the supply rails by more than 300 mV. Exceeding the limit causes these diodes to become forward-biased and start conducting into the substrate. These diodes can conduct up to 10 mA without causing irreversible damage to the device.

The C_1 capacitors in Figure 29 are typically 3 pF and are primarily attributed to pin capacitance. The R_1 resistors are lumped components made up of the on resistance of the switches. The value of these resistors is typically about 200 Ω . The C_2 capacitors are sampling capacitors of the ADC with a capacitance of 15 pF typically.

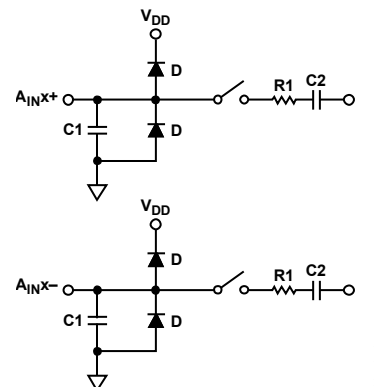

Figure 29. Equivalent Analog Input Circuit, Conversion Phase—Switches Open, Track Phase—Switches Closed

ADC TRANSFER FUNCTION

The AD7380/AD7381 can use a 2.5 V to 3.3 V V_{REF} . The AD7380/AD7381 convert the differential voltage of the analog inputs (A_{INA+} , A_{INA-} , A_{INB+} , and A_{INB-}) into a digital output. The conversion result is MSB first, two's complement. The LSB size is $(2 \times V_{REF})/2^N$, where N is the ADC resolution. The ADC resolution is determined by the resolution of the device chosen, and if resolution boost mode is enabled. Table 8 outlines the LSB size expressed in millivolts for different resolutions and reference voltages options.

The ideal transfer characteristic for the AD7380/AD7381 is shown in Figure 30.

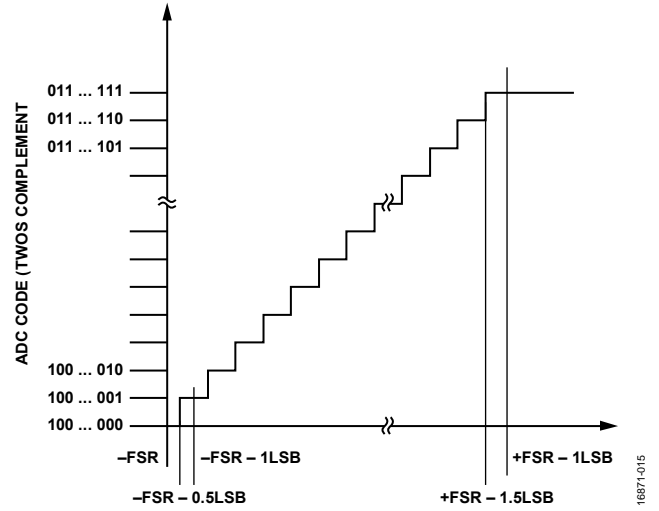

Figure 30. ADC Ideal Transfer Function (FSR = Full-Scale Range)

Table 8. LSB Size

| Resolution | 2.5 V Reference | 3.3 V Reference | Unit |
|------------|-----------------|-----------------|---------|
| 14-bit | 305.2 | 402.8 | μ V |
| 16-bit | 76.3 | 100.7 | μ V |
| 18-bit | 19.1 | 25.2 | μ V |

APPLICATIONS INFORMATION

Figure 31 shows an example of a typical application circuit for the AD7380/AD7381. Decouple the V_{CC} , V_{LOGIC} , REGCAP, and REFIO pins with suitable decoupling capacitors as shown.

The exposed pad is a ground reference point for circuitry on the device and must be connected to the board ground.

Place a differential RC filter on the analog inputs to ensure optimal performance is achieved. On a typical application, it is recommended that $R = 33 \Omega$, $C1 = 68 \text{ pF}$, and $C2 = 330 \text{ pF}$.

Figure 18 shows the SNR performance at different R values across the input frequency range.

The performance of the AD7380/AD7381 devices may be impacted by noise on the digital interface. This impact depends on the on-board layout and design. Keep a minimal distance between the digital line and the digital interface, or place a 100Ω resistor in series and close to the SDOA pin and SDOB/ALERT pin to reduce noise from the digital interface coupling of the AD7380/AD7381.

The two differential channels of the AD7380/AD7381 can accept an input voltage range from 0 V to V_{REF} and has a wide common-mode range that allows the conversion of a variety of signals. These analog input pins can easily be driven with an amplifier.

Table 9 lists the recommended driver amplifiers that best fit and add value to the application.

The AD7380/AD7381 has an internal 2.5 V reference and can use an ultralow noise, high accuracy voltage reference as an external voltage source ranging from 2.5 V to 3.3 V such as the [ADR4533](#) and [ADR4525](#).

POWER SUPPLY

The typical application circuit in Figure 31 can be powered by a single 5 V (V_{+}) voltage source that supplies the whole signal chain. The 5 V supply can come from a low noise, complementary metal-oxide semiconductor (CMOS) low dropout (LDO) regulator ([ADP7105](#)). The driver amplifier supply is provided by the +5 V (V_{+}) and -2.5 V (V_{-}), which is derived from the inverter, for example, the [ADM660](#). The inverter then converts the +5 V to -5 V and supplies this voltage to the [ADP7182](#) low noise voltage regulator to output the -2.5 V .

The two independent supplies of the AD7380/AD7381, V_{CC} and V_{LOGIC} , that supply the analog circuitry and digital interface, respectively, can be supplied by a low quiescent current LDO regulator such as the [ADP166](#). The [ADP166](#) is a suitable supply with a fixed output voltage range from 1.2 V to 3.3 V for typical V_{CC} and V_{LOGIC} levels. Decouple both the V_{CC} supply and the V_{LOGIC} supply separately with a $1 \mu\text{F}$ capacitor. Additionally, there is an internal LDO regulator that supplies the AD7380/AD7381. The on-chip regulator provides a 1.9 V supply for internal use on the device only. Decouple the REGCAP pin with a $1 \mu\text{F}$ capacitor connected to GND.

Power-Up

The AD7380/AD7381 are robust to power supply sequencing. V_{CC} and V_{LOGIC} can be applied in any sequence. After V_{CC} and V_{LOGIC} are applied, an external reference must be applied.

The AD7380/AD7381 require a $t_{POWERUP}$ time from applying V_{CC} and V_{LOGIC} until the ADC conversion results are stable. Applying \overline{CS} pulses, or interfacing with the AD7380/AD7381 prior to the setup time elapsing, does not have a negative impact on ADC operation. Conversion results are not guaranteed to meet data sheet specifications during this time, however, and must be ignored.

Table 9. Signal Chain Components

| Companion Parts | Part Name | Description | Typical Application |
|--------------------|---------------------------|--|--|
| ADC Driver | ADA4896-2 | 1 nV/ $\sqrt{\text{Hz}}$, rail to rail output amplifier | Precision, low noise, high frequency |
| | ADA4940-2 | Ultralow power, full differential, low distortion | Precision, low density, low power |
| | ADA4807-2 | 1 mA, rail-to-rail output amplifier | Precision, low power, high frequency |
| External Reference | ADR4525 | Ultralow noise, high accuracy 2.5 V voltage reference | 2.5 V reference voltage |
| | ADR4533 | Ultralow noise, high accuracy 3.3 V voltage reference | 3.3 V reference voltage |
| LDO Regulator | ADP166 | Low quiescent, 150 mA, LDO regulator | 3.0 V to 3.6 V supply for V_{CC} and V_{LOGIC} |
| | ADP7104 | Low noise, CMOS LDO regulator | 5 V supply for driver amplifier |
| | ADP7182 | Low noise line regulator | -2.5 V supply for driver amplifier |

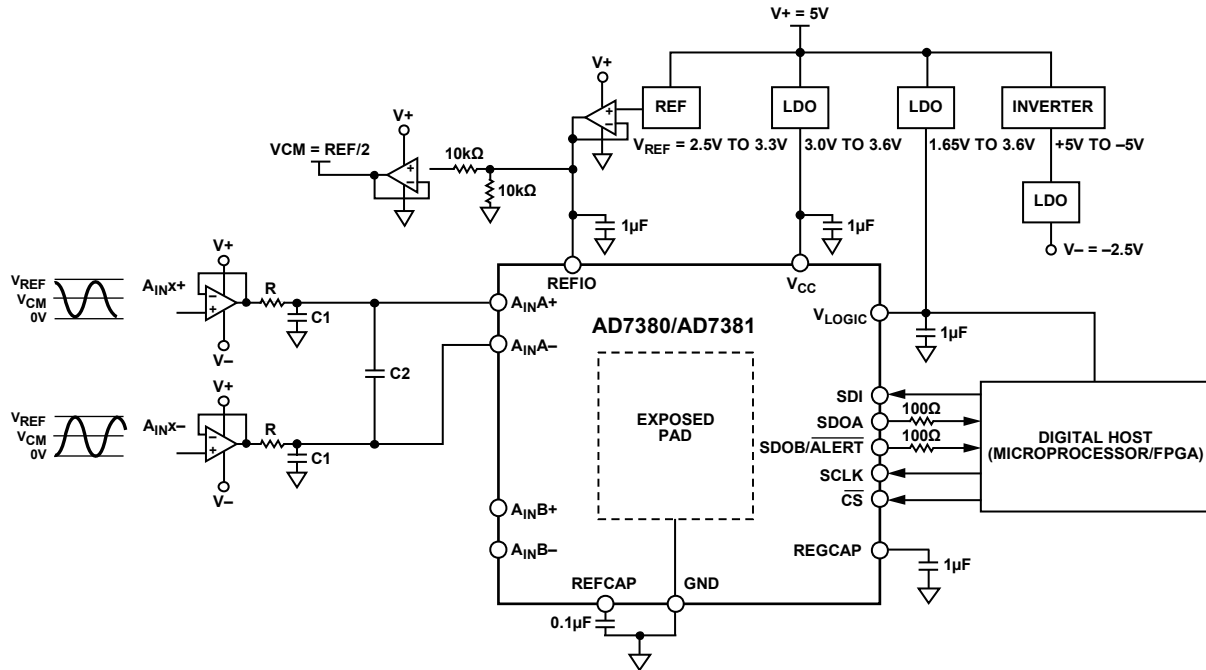

Figure 31. Typical Application Circuit

16871-016

MODES OF OPERATION

The AD7380/AD7381 have several on-chip configuration registers for controlling the operational mode of the device.

OVERSAMPLING

Oversampling is a common method used in analog electronics to improve the accuracy of the ADC result. Multiple samples of the analog input are captured and averaged to reduce the noise component from quantization noise and thermal noise (kTC) of the ADC. The AD7380/AD7381 offer an oversampling function on-chip and have two user configurable oversampling modes, normal average and rolling average.

The oversampling functionality is configured by programming the OS_MODE bit and OSR bits in the CONFIGURATION1 register.

Normal Average Oversampling

Normal average oversampling mode can be used in applications where slower output data rates are allowable and where higher SNR or dynamic range is desirable. Normal average oversampling involves taking a number of samples, adding the samples together, and dividing the result by the number of samples taken. This result is then output from the device. The sample data is cleared after the process is completed.

Normal average oversampling mode is configured by setting the OS_MODE bit to Logic 0 and having a valid nonzero value in the OSR bits. Writing to the OSR bits has a two cycle latency

before the register gets updated. The oversampling ratio of the digital filter is controlled using the oversampling bits, OSR, which provides the oversampling bit decoding to select the different oversample rates. The output result is decimated to 16-bit resolution for the AD7380 and 14-bit resolution for the AD7381. If additional resolution is required, configure the resolution boost bit in the CONFIGURATION1 register. See the Resolution Boost section for further details.

The number of samples, n , defined by the OSR bits are taken, added together, and the result is divided by n . The initial ADC conversion is initiated by the falling edge of \overline{CS} , and the AD7380/AD7381 control all subsequent samples in the oversampling sequence internally. The sampling rate of the additional n samples is at 3 MSPS for the AD7380 and 4 MSPS for AD7381 in normal average oversampling mode. The oversampled conversion result is ready for read back on the next serial interface access. After the technique is applied, the sample data used in the calculation is discarded. This process is repeated every time the application needs a new conversion result and initiates at the falling edge of \overline{CS} .

As the output data rate is reduced by the oversampling ratio, the serial peripheral interface (SPI) SCLK frequency required to transmit the data is also reduced accordingly.

Table 10. AD7380/AD7381 Normal Average Oversampling Performance Overview

| Oversampling Ratio | AD7380 | | | | | AD7381 | | |
|--------------------|--------------------------|---------|--------------------------|---------|---------------------------------|------------------|---------|---------------------------------|
| | SNR (dB typical) | | | | Output Data Rate (kSPS Maximum) | SNR (dB typical) | | Output Data Rate (kSPS Maximum) |
| | $V_{REF} = 2.5\text{ V}$ | | $V_{REF} = 3.3\text{ V}$ | | | RES = 0 | RES = 1 | |
| | RES = 0 | RES = 1 | RES = 0 | RES = 1 | | | | |
| Disabled | 90.8 | 90.8 | 92.5 | 92.5 | 4000 | 85.2 | 85.2 | 4000 |
| 2 | 92.6 | 93.6 | 94.0 | 95.5 | 1500 | 84.7 | 88 | 2000 |
| 4 | 94.3 | 96.5 | 95.4 | 98.2 | 750 | 85.2 | 91.1 | 1000 |
| 8 | 95.8 | 99.2 | 96.3 | 100.5 | 375 | 85.5 | 93 | 500 |
| 16 | 96.3 | 100.4 | 96.8 | 102.0 | 187.5 | 85.7 | 94.6 | 250 |
| 32 | 96.5 | 100.5 | 97.0 | 102.8 | 93.75 | 85.9 | 95.6 | 125 |

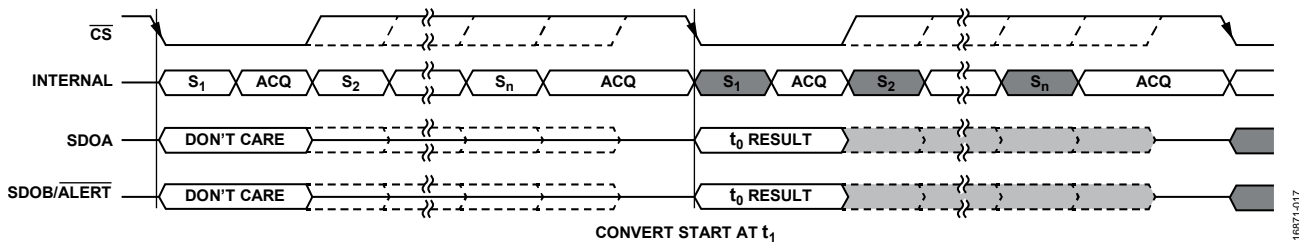

Figure 32. Normal Average Oversampling Operation

Rolling Average Oversampling

Rolling average oversampling mode can be used in applications where higher output data rates are required and where higher SNR or dynamic range is desirable. Rolling average oversampling involves taking a number of samples, adding the samples together, and dividing the result by the number of samples taken. This result is then output from the device. The sample data is not cleared after the process is completed. The rolling average oversampling mode uses a first in, first out (FIFO) buffer of the most recent samples in the averaging calculation, allowing the ADC throughput rate and output data rate to stay the same.

Rolling average oversampling mode is configured by setting the OS_MODE bit to Logic 1 and having a valid nonzero value in the OSR bits. The oversampling ratio of the digital filter is controlled using the oversampling bits, OSR (see Table 11). The output result is decimated to 16-bit resolution for the AD7380 and 14-bit result for the AD7381. If additional resolution is required, this resolution can be achieved by configuring the resolution boost bit in the CONFIGURATION1 register. See the Resolution Boost section for further details.

In rolling average oversampling mode, all ADC conversions are controlled and initiated by the falling edge of \overline{CS} . After a conversion is complete, the result is loaded into the FIFO. The FIFO length is 8, regardless of the oversampling ratio set. The FIFO is filled on the first conversion after a power-on reset, the first conversion after a software controlled hard or soft reset, or the first conversion after the REFSEL bit is toggled. A new conversion result is shifted into the FIFO on completion of every ADC conversion, regardless of the status of the OSR bits and the OS_MODE bit. This conversion allows a seamless transition from no oversampling to rolling average oversampling, or different rolling average oversampling ratios without waiting for the FIFO to fill.

The number of samples, n, defined by the OSR bits are taken from the FIFO, added together, and the result is divided by n. The time between \overline{CS} falling edges is the cycle time which can be controlled by the user, depending on the desired data output rate.

Table 11. AD7380/AD7381 Rolling Averaging Oversampling Performance Overview

| Oversampling Ratio | AD7380 | | | | Output Data Rate (kSPS Maximum) | AD7381 | | Output Data Rate (kSPS Maximum) |
|--------------------|--------------------------|---------|--------------------------|---------|---------------------------------|------------------|---------|---------------------------------|
| | SNR (dB typical) | | | | | SNR (dB typical) | | |
| | V _{REF} = 2.5 V | | V _{REF} = 3.3 V | | | RES = 0 | RES = 1 | |
| | RES = 0 | RES = 1 | RES = 0 | RES = 1 | | | | |
| Disabled | 91 | 91 | 92.5 | 92.5 | 4000 | 85 | 85 | 4000 |
| 2 | 92 | 93 | 93.2 | 94.5 | 4000 | 84.5 | 87.7 | 4000 |
| 4 | 94 | 96 | 94.8 | 97.2 | 4000 | 85 | 91 | 4000 |
| 8 | 95.5 | 98.6 | 95.9 | 99.6 | 4000 | 85.5 | 93 | 4000 |

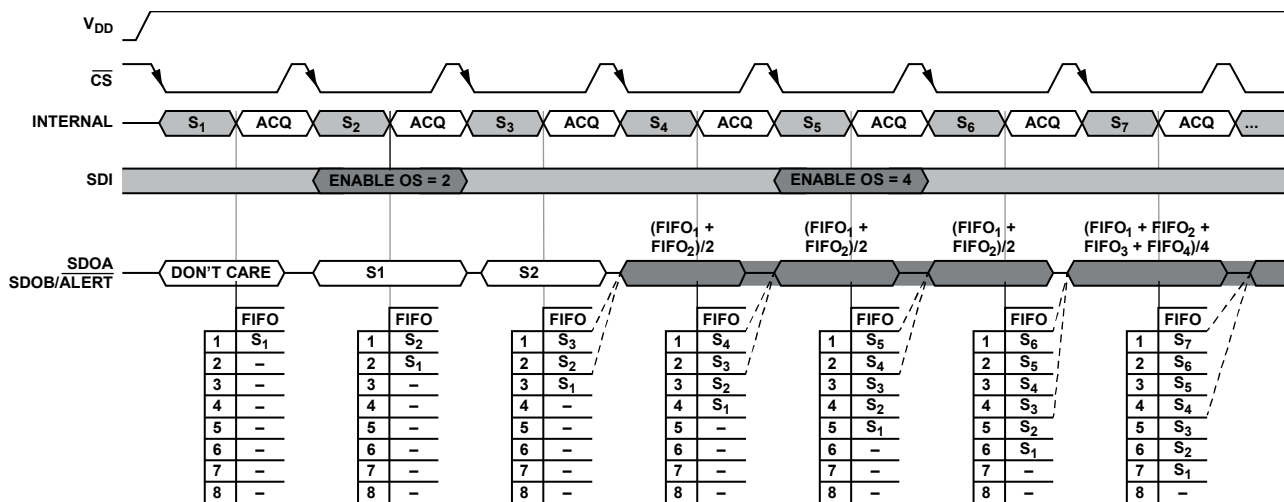

Figure 33. Rolling Average Oversampling Operation

RESOLUTION BOOST

The default conversion result output data size for the AD7380 is 16 bits and for the AD7381 is 14 bits. When the on-chip oversampling function is enabled, the performance of the ADC can exceed the 16-bit level for the AD7380 or the 14-bit level for the AD7381. To accommodate the performance boost achievable, enable an additional two bits of resolution. If the RES bit in the CONFIGURATION1 register is set to Logic 1 and the AD7380/AD7381 are in a valid oversampling mode, the conversion result size for the AD7380 is 18 bits and for the AD7381 is 16 bits. In this mode, 18 SCLK cycles are required to propagate the data for the AD7380 and 16 SCLK cycles are required for the AD7381.

ALERT

The alert functionality is an out of range indicator and can be used as an early indicator of an out of bounds conversion result. An alert event triggers when the conversion result value register exceeds the alert high limit value in the ALERT_HIGH_THRESHOLD register or falls below the alert low limit value in the ALERT_LOW_THRESHOLD register. The ALERT_HIGH_THRESHOLD register and the ALERT_LOW_THRESHOLD register are common to all ADCs. When setting the threshold limits, the alert high threshold must always be greater than the alert low threshold. Detailed alert information is accessible in the ALERT register.

The register contains two status bits per ADC, one corresponding to the high limit, and the other to the low limit. A logical OR of alert signals for all ADCs creates a common alert value. This value can be configured to drive out on the ALERT function of the SDOB/ALERT pin. The SDOB/ALERT pin is configured as ALERT by configuring the following bits in the CONFIGURATION1 register and the CONFIGURATION2 register:

- Set the SDO bit to 1.
- Set the ALERT_EN bit to 1.

In addition, set a valid value to the ALERT_HIGH_THRESHOLD register and the ALERT_LOW_THRESHOLD register.

The alert indication function is available in oversampling, both rolling average and normal average, and in nonoversampling modes.

The ALERT function of the SDOB/ALERT pin gets updated at the end of conversion. The alert indication status bits in the ALERT register get updated as well and must be read before the end of next conversion. The ALERT function of the SDOB/ALERT pin is cleared with a falling edge of CS. Issuing a software reset also clears the alert status in the ALERT register.

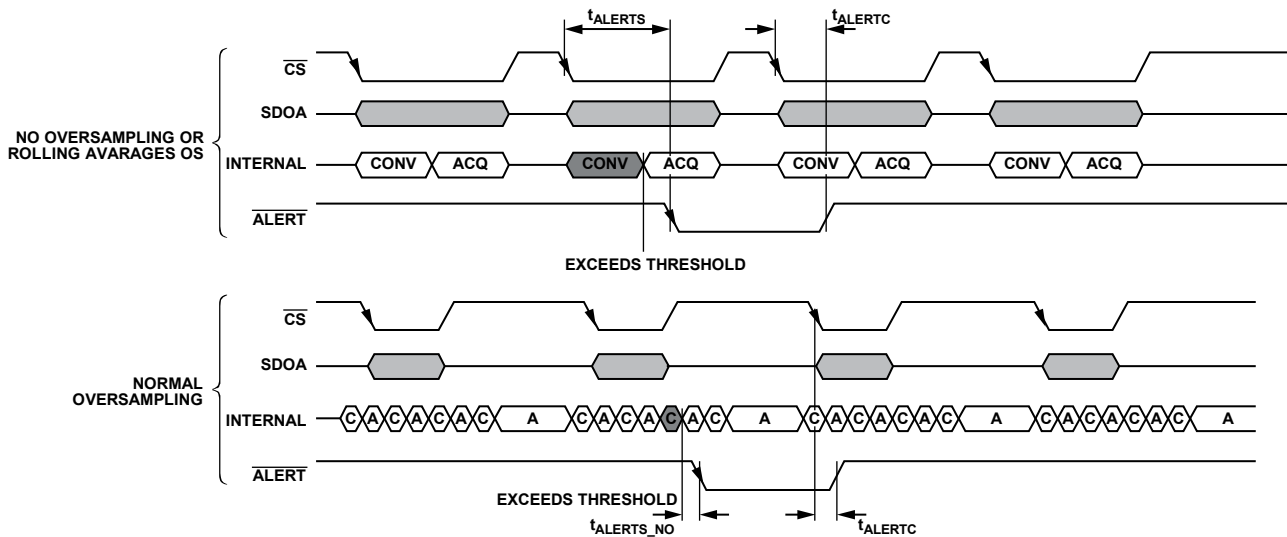

Figure 34. Alert Operation

16871-019

POWER MODES

The AD7380/AD7381 have two power modes that can be set in the CONFIGURATION1 register, normal mode and shutdown mode. These modes of operation provide flexible power management options, allowing optimization of the power dissipation and throughput rate ratio for different application requirements.

Program the PMODE bit in the CONFIGURATION1 register to configure the power modes in the AD7380/AD7381. Set PMODE to Logic 0 for normal mode and Logic 1 for shutdown mode.

Normal Mode

Keep the AD7380/AD7381 in normal mode to achieve the fastest throughput rate. All blocks within the AD7380/AD7381 remain fully powered at all times, and an ADC conversion can be initiated by a falling edge of CS, when required. When the AD7380/AD7381 are not converting, the devices are in static mode, and power consumption is automatically reduced. Additional current is required to perform a conversion. Therefore, power consumption on the AD7380/AD7381 scales with throughput.

Shutdown Mode

When slower throughput rates and lower power consumption are required, use shutdown mode by either powering down the ADC between each conversion or by performing a series of conversions at a high throughput rate and then powering down the ADC for a relatively long duration between these burst conversions. When the AD7380/AD7381 are in shutdown mode, all analog circuitry powers down, including the internal reference, if enabled. The serial interface remains active during shutdown mode to allow the AD7380/AD7381 to exit shutdown mode.

To enter shutdown mode, write to the PMODE bit in the CONFIGURATION1 register. The AD7380/AD7381 shuts down and current consumption reduces.

To exit shutdown mode and return to normal mode, set the PMODE bit in the CONFIGURATION1 register to Logic 0. All register configuration settings remain unchanged entering or

leaving shutdown mode. After exiting shutdown mode, allow sufficient time for the circuitry to turn on before starting a conversion. If the internal reference is enabled, allow the reference to settle for accurate conversions to happen.

INTERNAL AND EXTERNAL REFERENCE

The AD7380/AD7381 have a 2.5 V internal reference. Alternatively, if a more accurate reference or higher dynamic range is required, an external reference can be supplied. An externally supplied reference can be in the range of 2.5 V to 3.3 V.

Reference selection, internal/external, is configured by the REFSEL bit in the CONFIGURATION1 register. If REFSEL is set to 0, the internal reference buffer is enabled. If an external reference is preferred, the REFSEL bit must be set to 1, and an external reference must be supplied to the REFIO pin.

SOFTWARE RESET

The AD7380/AD7381 have two reset modes, a soft reset and a hard reset. A reset is initiated by writing to the RESET bits, Bits[7:0], in the CONFIGURATION2 register.

A soft reset maintains the contents of the configurable registers but refreshes the interface and the ADC blocks. Any internal state machines are reinitialized, and the oversampling block and FIFO are flushed. The ALERT register is cleared. The reference and LDO remain powered.

A hard reset, in addition to the blocks reset by a soft reset, resets all user registers to the default status, resets the reference buffer, and resets the internal oscillator block.

DIAGNOSTIC SELF TEST

The AD7380/AD7381 run a diagnostic self test after a power-on reset (POR) or after a software hard reset to ensure correct configuration is loaded into the device.

The result of the self test is displayed in the SETUP_F bit in the ALERT register. If the SETUP_F bit is set to Logic 1, the diagnostic self test fails. If the test fails, perform a software hard reset to reset the AD7380/AD7381 registers to the default status.

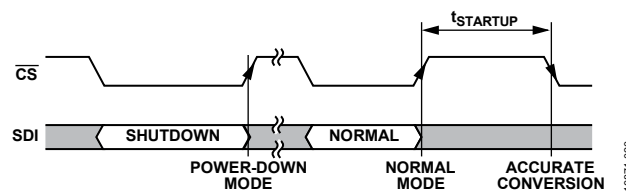

Figure 35. Shutdown Mode Operation

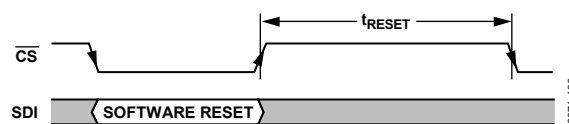

Figure 36. Software Reset Operation

INTERFACE

The interface to the AD7380/AD7381 is via the SPI. The interface consists of a \overline{CS} , SCLK, SDOA, SDOB/ \overline{ALERT} , and SDI pins.

The \overline{CS} signal frames a serial data transfer and initiates an ADC conversion process. The falling edge of \overline{CS} puts the track-and-hold into hold mode, at which point, the analog input is sampled, and the bus is taken out of three-state.

The SCLK signal synchronizes data in and out of the device via the SDOA, SDOB, and SDI signals. A minimum of 16 SCLK cycles are required for a write to or read from a register. The minimum numbers of SCLK pulses for a conversion read is dependent on the resolution of the device and the configuration settings, see Table 12.

The ADC conversion operation is driven internally by an on-board oscillator and is independent of the SCLK signal.

The AD7380/AD7381 have two serial output signals, SDOA and SDOB. To achieve the highest throughput of the device, use both SDOA and SDOB, 2-wire mode, to read the conversion results. If a reduced throughput is required or oversampling is used, it is possible to use 1-wire mode, SDOA signal only, for reading conversion results. Programming the SDO bit in the CONFIGURATION2 register configures 2-wire or 1-wire mode.

Configuring the cyclic redundancy check (CRC) operation for SPI reads or SPI writes alters the operation of the interface. The relevant sections of this data sheet must be consulted to ensure correct operation.

READING CONVERSION RESULTS

The \overline{CS} signal initiates the conversion process. A high to low transition on the \overline{CS} signal initiates a simultaneous conversion of both ADCs, ADC A and ADC B. The AD7380/AD7381 have one cycle readback latency. Therefore, the conversion results are available on the next SPI access. Then, take the \overline{CS} signal low, and the conversion result clocks out on the serial output pins. The next conversion also initiates at this point.

The conversion result shifts out of the device as a 16-bit result for the AD7380 and a 14-bit result for the AD7381. The MSB of the conversion result shifts out on the \overline{CS} falling edge. The remaining data shifts out of the device under the control of the SCLK input. The data shifts out on the rising edge of the SCLK, and the data bits are valid on both the falling edge and the rising edge. After the final SCLK falling edge, take \overline{CS} high again to return the SDOA and the SDOB/ \overline{ALERT} pins to a high impedance state.

The number of SCLK cycles to propagate the conversion results on the SDOA and the SDOB/ \overline{ALERT} pins is dependent on the serial mode of operation configured and if resolution boost mode is enabled, see Figure 37 and Table 12 for details. If CRC reading is enabled, this requires additional SCLK pulses to propagate the CRC information, see the CRC section for more details.

As the \overline{CS} signal initiates a conversion, as well as framing the data, any data access must be completed within a single frame.

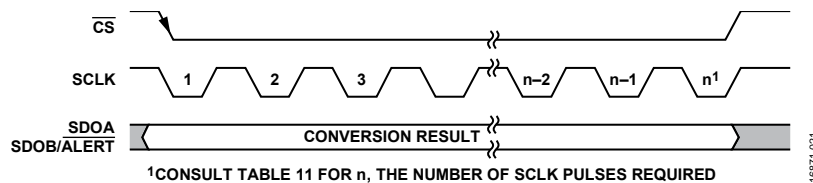

Figure 37. Reading Conversion Result

Table 12. Number of SCLKs, n, Required for Reading Conversion Results

| Interface Configuration | Resolution Boost Mode | CRC Read | Number of SCLK Pulses | |
|-------------------------|-----------------------|----------|-----------------------|--------|
| | | | AD7380 | AD7381 |
| 2-Wire | Disabled | Disabled | 16 | 14 |
| | | Enabled | 24 | 22 |
| | Enabled | Disabled | 18 | 16 |
| | | Enabled | 26 | 24 |
| 1-Wire | Disabled | Disabled | 32 | 28 |
| | | Enabled | 40 | 36 |
| | Enabled | Disabled | 36 | 32 |
| | | Enabled | 44 | 40 |

Serial 2-Wire Mode

Configure 2-wire mode by setting the SDO bit in the CONFIGURATION2 register to 0. In 2-wire mode, the conversion result for ADC A is output on the SDOA pin, and the conversion result for ADC B is output on the SDOB/ALERT pin (see Figure 38).

Serial 1-Wire Mode

In applications where slower throughput rates are allowed, or normal average oversampling is used, the serial interface can operate in 1-wire mode. In 1-wire mode, the conversion results from ADC A and ADC B are output on the serial output, SDOA. Additional SCLK cycles are required to propagate all data. The ADC A data is output first, followed by the ADC B conversion results (see Figure 39).

Resolution Boost Mode

The default resolution and output data size for the AD7380 is 16 bits and for the AD7381 is 14 bits. Enabling the on-chip oversampling function reduces noise and improves the device

performance. To accommodate the performance boost achievable, enable an additional two bits of resolution in the conversion output data. If the RES bit in the CONFIGURATION1 register is set to Logic 1 and the AD7380/AD7381 are in a valid oversampling mode, the conversion result size for the AD7380 is 18 bit and for the AD7381 is 16 bit.

When the resolution boost mode is enabled, 18 SCLK cycles are required for the AD7380 and 16 SCLK cycles are required for the AD7381 to propagate the data.

LOW LATENCY READBACK

The interface on the AD7380/AD7381 has one cycle latency, as shown in Figure 40. For applications that operate at lower throughput rates, the latency of reading the conversion result can be reduced. When the conversion time elapses, $t_{CONVERT}$, a second CS pulse after the initial CS pulse that initiates the conversion can readback the conversion result. This operation is shown in Figure 40.

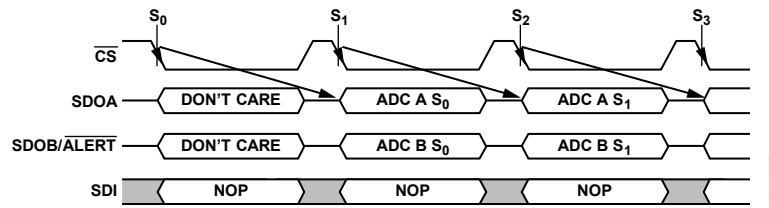

Figure 38. Reading Conversion Results for 2-Wire Mode

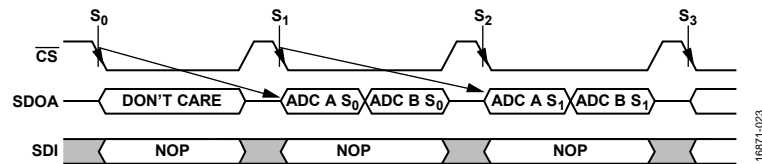

Figure 39. Read Conversion Results for 1-Wire Mode

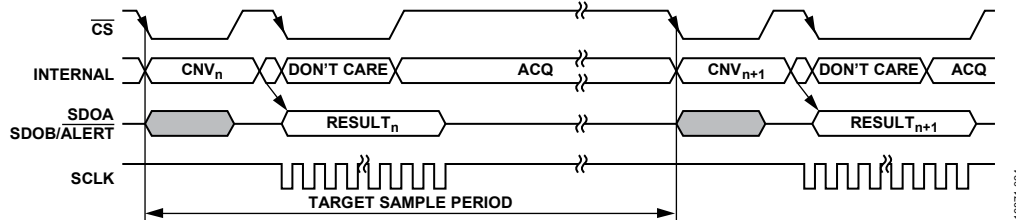

Figure 40. Low Throughput Low Latency

READING FROM DEVICE REGISTERS

All registers in the device can be read over the SPI. A register read is performed by issuing a register read command followed by an additional SPI command that can be either a valid command or no operation (NOP) command. The format for a read command is shown in Table 15. Bit D15 must be set to 0 to select a read command. Bits[D14:D12] contain the register address, and the subsequent twelve bits, Bits[D11:D0], are ignored.

WRITING TO DEVICE REGISTERS

All the read and write registers in the AD7380/AD7381 can be written to over the SPI. The length of an SPI write access is determined by the CRC write function. An SPI access is 16 bit if CRC write is disabled and is 24 bit when CRC write is enabled. The format for a write command is shown in Table 15. Bit D15 must be set to 1 to select a write command. Bits[D14:D12] contain the register address, and the subsequent twelve bits, Bits[D11:D0], contain the data to be written to the selected register.

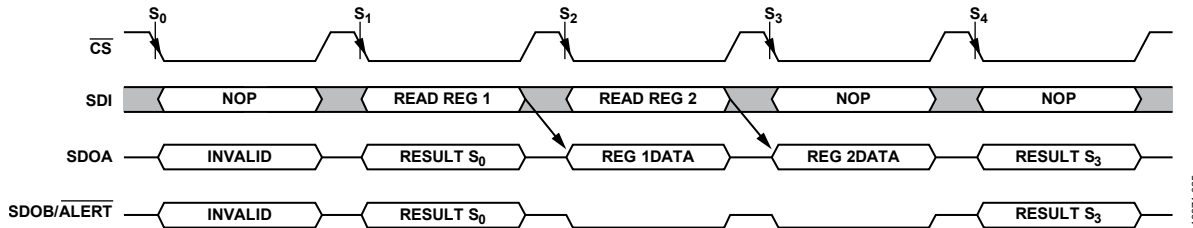

Figure 41. Register Read

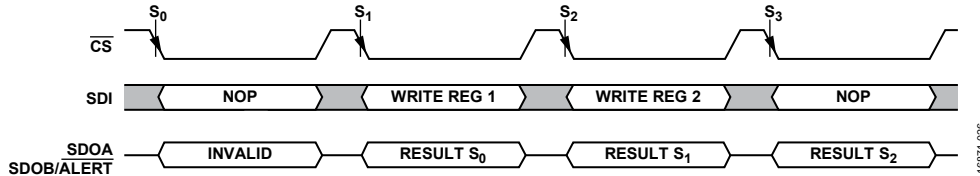

Figure 42. Register Write

CRC

The AD7380/AD7381 have CRC checksum modes that can be used to improve interface robustness by detecting errors in data transmissions. The CRC feature is independently selectable for SPI interface reads and SPI interface writes. For example, the CRC function for SPI writes can prevent unexpected changes to the device configuration but disabled on SPI reads, therefore maintaining a higher throughput rate. The CRC feature is controlled by the programming of the CRC_W and CRC_R bits in the CONFIGURATION1 register.

CRC Read

If enabled, a CRC is appended to the conversion result or register reads and consists of an 8-bit word. The CRC is calculated in the conversion result for ADC A and ADC B and is output on SDOA. A CRC is also calculated and appended to register read outputs.

The CRC read function can be used in 2-wire SPI mode, 1-wire SPI mode, and resolution boost mode.

CRC Write

To enable the CRC write function, the CRC_W bit in the CONFIGURATION1 register must be set to 1. To set the CRC_W bit to 1 to enable the CRC feature, the request frame must have a valid CRC appended to the frame.

After the CRC feature is enabled, all register write requests are ignored unless accompanied by a valid CRC command, requiring a valid CRC to both enable and disable the CRC write feature.

CRC Polynomial

For CRC checksum calculations, the following polynomial is always used: $x^8 + x^2 + x + 1$

To generate the checksum, the 16-bit data conversion result of the two channels are combined to produce 32-bit data. The 8 MSBs of the 32-bit data are inverted and then left shifted by eight bits to create a number ending in eight logic zeros. The polynomial is aligned such that the MSB is adjacent to the leftmost Logic 1 of the data. An exclusive or (XOR) function is applied to the data to produce a new, shorter number. The polynomial is again aligned such that the MSB is adjacent to the leftmost Logic 1 of the new result, and the procedure is repeated. This process repeats until the original data is reduced to a value less than the polynomial, which is the 8-bit checksum. The polynomial for this example is 100000111.

Let the original data of two channels be 0xAAAA and 0x5555, that is, 1010 1010 1010 1010 and 0101 0101 0101 0101. The data of the two channels is appended including eight zeros on the right, and then becomes 1010 1010 1010 1010 0101 0101 0101 0101 0000 0000.

Table 13 shows the CRC calculation of 16-bit two-channel data. In the final XOR operation, the reduced data is less than the polynomial. Therefore, the remainder is the CRC for the assumed data.

The same process is followed for the AD7381, but instead of dealing with 32-bit data (combined result of two channels), it is 28-bit data. For reading data such as the registers, CRC computation is based on a 16-bit register data, and the same process is performed as described for a 32-bit data.

REGISTERS

The AD7380/AD7381 have user programmable on-chip registers for configuring the device. Table 14 shows a complete overview of the registers available on the AD7380/AD7381. The registers are either read/write (R/W) or read only (R). Any read request to a write only register is ignored. Any write request to a read only register is ignored. Writes to any other register address are considered an NOP and are ignored. Any read request to a register address, other than those listed in Table 14, are considered an NOP, and the data transmitted in the next SPI frame are the conversion results.

Table 14. Register Summary

| Hex. No. | Register Name | Bits | Bit 15 | Bit 14 | Bit 13 | Bit 12 | Bit 11 | Bit 10 | Bit 9 | Bit 8 | Reset | R/W | |
|----------|----------------------|--------|-----------------|-----------|----------|----------|------------------|-----------|----------|---------|--------|--------|-----|
| | | | Bit 7 | Bit 6 | Bit 5 | Bit 4 | Bit 3 | Bit 2 | Bit 1 | Bit 0 | | | |
| 0x1 | CONFIGURATION1 | [15:8] | ADDRESSING | | | | RESERVED | | OS_MODE | OSR[2] | 0x0000 | R/W | |
| | | [7:0] | OSR[1:0] | CRC_W | CRC_R | ALERT_EN | RES | REFSEL | PMODE | | | | |
| 0x2 | CONFIGURATION2 | [15:8] | ADDRESSING | | | | RESERVED | | | SDO | 0x0000 | R/W | |
| | | [7:0] | RESET | | | | | | | | | | |
| 0x3 | ALERT | [15:8] | ADDRESSING | | | | RESERVED | | CRCW_F | SETUP_F | 0x0000 | R | |
| | | [7:0] | RESERVED | AL_B_HIGH | AL_B_LOW | RESERVED | | AL_A_HIGH | AL_A_LOW | | | | |
| 0x4 | ALERT_LOW_THRESHOLD | [15:8] | ADDRESSING | | | | ALERT_LOW[11:8] | | | | | 0x0800 | R/W |
| | | [7:0] | ALERT_LOW[7:0] | | | | | | | | | | |
| 0x5 | ALERT_HIGH_THRESHOLD | [15:8] | ADDRESSING | | | | ALERT_HIGH[11:8] | | | | | 0x07FF | R/W |
| | | [7:0] | ALERT_HIGH[7:0] | | | | | | | | | | |

ADDRESSING REGISTERS

A serial register transfer on the AD7380/AD7381 consists of 16 SCLK cycles. The four MSBs written to the device are decoded to determine which register is addressed. The four MSBs consist of the register address (REGADDR), Bits[2:0], and the read/write bit (WR). The register address bits determine which on-chip register is selected. The read/write bit determines if the remaining 12 bits of data on the SDI input are loaded into the addressed register, if the addressed register is a valid write register. If the WR bit is 1, the bits load into the register addressed by the register select bits. If the WR bit is 0, the command is seen as a read request. The addressed register data is available to be read during the next read operation.

Table 15. Addressing Register Format

| MSB | | | | | | | | | | | | | LSB | | |
|-----|--------------|-----|-----|------------|-----|----|----|----|----|----|----|----|-----|----|----|
| D15 | D14 | D13 | D12 | D11 | D10 | D9 | D8 | D7 | D6 | D5 | D4 | D3 | D2 | D1 | D0 |
| WR | REGADDR[2:0] | | | DATA[11:0] | | | | | | | | | | | |

Table 16. Bit Descriptions for Addressing Registers

| Bit | Mnemonic | Description |
|------------|------------|---|
| D15 | WR | If a 1 is written to this bit, Bits[D11:D0] of this register are written to the register specified by REGADDR, if it is a valid address. Alternatively, if a 0 is written, the next data sent out on the SDOA pin is a read from the designated register, if it is a valid address. |
| D14 to D12 | REGADDR | When WR = 1, the contents of REGADDR determine the register for selection as outlined in Table 14. When WR = 0, and REGADDR contains a valid register address, the contents on the requested register are output on the SDOA pin during the next interface access. When WR = 0, and REGADDR contains 0x0, 0x6, or 0x7, the contents on the SDI line are ignored. The next interface access results in the conversion results being read back. |
| D11 to D0 | DATA[11:0] | These bits are written into the corresponding register specified by the REGADDR bits when the WR bit is equal to 1 and the REGADDR bits contain a valid address. |

CONFIGURATION1 REGISTER

Address: 0x1, Reset: 0x0000, Name: CONFIGURATION1

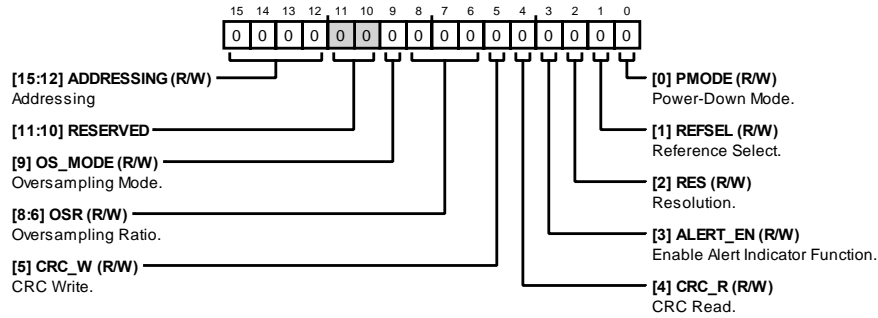

Table 17. Bit Descriptions for CONFIGURATION1

| Bits | Bit Name | Description | Reset | Access |
|---------|------------|---|-------|--------|
| [15:12] | ADDRESSING | Addressing. Bits[15:12] define the address of the relevant register. See the Addressing Registers section for further details. | 0x0 | R/W |
| [11:10] | RESERVED | Reserved. | 0x0 | R |
| 9 | OS_MODE | Oversampling Mode. Sets the oversampling mode of the ADC. 0: normal average. 1: rolling average. | 0x0 | R/W |
| [8:6] | OSR | Oversampling Ratio. Sets the oversampling ratio for all the ADCs in the relevant mode. Normal average mode supports oversampling ratios of ×2, ×4, ×8, ×16, and ×32. Rolling average mode supports oversampling ratios of ×2, ×4, and ×8. 000: disabled. 001: 2×. 010: 4×. 011: 8×. 100: 16×. 101: 32×. 110: disabled. 111: disabled. | 0x0 | R/W |
| 5 | CRC_W | CRC Write. Controls the CRC functionality for the SDI interface. When setting this bit from a 0 to a 1, the command must be followed by a valid CRC to set this configuration bit. If a valid CRC is not received, the entire frame is ignored. If the bit is set to 1, it requires a CRC to clear it to 0. 0: no CRC function. 1: CRC function. | 0x0 | R/W |
| 4 | CRC_R | CRC Read. Controls the CRC functionality for the SDOA and SDOB/ALERT interface. 0: no CRC function. 1: CRC function. | 0x0 | R/W |
| 3 | ALERT_EN | Enable Alert Indicator Function. This register functions when the SDO bit = 1. Otherwise, the ALERT_EN bit is ignored. 0: SDOB. 1: ALERT. | 0x0 | R/W |
| 2 | RES | Resolution. Sets the size of the conversion result data. If OSR = 0, these bits are ignored, and the resolution is set to default resolution. 0: normal resolution. 1: 2-bit higher resolution. | 0x0 | R/W |
| 1 | REFSEL | Reference Select. Selects the ADC reference source. 0: selects internal reference. 1: selects external reference. | 0x0 | R/W |
| 0 | PMODE | Power-Down Mode. Sets the power modes. 0: normal mode. 1: power-down mode. | 0x0 | R/W |

CONFIGURATION2 REGISTER

Address: 0x2, Reset: 0x0000, Name: CONFIGURATION2

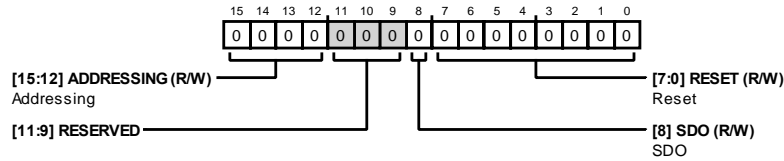

Table 18. Bit Descriptions for CONFIGURATION2

| Bits | Bit Name | Description | Reset | Access |
|---------|------------|---|-------|--------|
| [15:12] | ADDRESSING | Addressing. Bits[15:12] define the address of the relevant register. See the Addressing Registers section for further details. | 0x0 | R/W |
| [11:9] | RESERVED | Reserved. | 0x0 | R |
| 8 | SDO | SDO. Conversion results serial data output. 0: 2-wire, conversion data are output on both the SDOA and SDOB/ALERT pins. 1: 1-wire, conversion data are output on the SDOA pin only. | 0x0 | R/W |
| [7:0] | RESET | Reset. Set to 0x3C to perform a soft reset, which refreshes some block and register contents remain unchanged. Clears ALERT register and flushes any oversampling stored variables or active state machine. Set to 0xFF to perform a hard reset, which resets all possible blocks in the device. Register contents are set to defaults. All other values are ignored. | 0x0 | R/W |

ALERT REGISTER

Address: 0x3, Reset: 0x0000, Name: ALERT

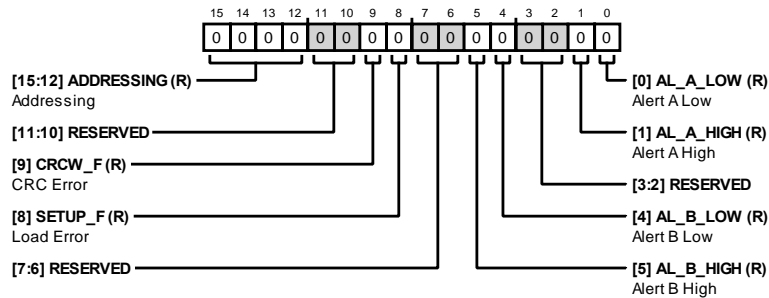

Table 19. Bit Descriptions for ALERT

| Bits | Bit Name | Description | Reset | Access |
|---------|------------|--|-------|--------|
| [15:12] | ADDRESSING | Addressing. Bits[15:12] define the address of the relevant register. See the Addressing Registers section for further details. | 0x0 | R |
| [11:10] | RESERVED | Reserved. | 0x0 | R |
| 9 | CRCW_F | CRC Error. Indicates that a register write command failed due to a CRC error. This fault bit is sticky and remains set until the register is read. 0: no CRC error. 1: CRC error. | 0x0 | R |
| 8 | SETUP_F | Load Error. The SETUP_F bit indicates that the device configuration data did not load correctly on startup. This bit does not clear on an ALERT register read. A hard reset via the CONFIGURATION2 register is required to clear this bit and restart the device setup again. 0: no setup error. 1: setup error. | 0x0 | R |
| [7:6] | RESERVED | Reserved. | 0x0 | R |

| Bits | Bit Name | Description | Reset | Access |
|-------|-----------|---|-------|--------|
| 5 | AL_B_HIGH | Alert B High. The alert indication high bits indicate if a conversion result for the respective input channel exceeds the value set in the ALERT_HIGH_THRESHOLD register. This fault bit is sticky and remains set until the register is read. 0: no alert indication. 1: alert indication. | 0x0 | R |
| 4 | AL_B_LOW | Alert B Low. The alert indication low bits indicate if a conversion result for the respective input channel exceeds the value set in the ALERT_LOW_THRESHOLD register. This fault bit is sticky and remains set until the register is read. 0: no alert indication. 1: alert indication. | 0x0 | R |
| [3:2] | RESERVED | Reserved. | 0x0 | R |
| 1 | AL_A_HIGH | Alert A High. The alert indication high bits indicate if a conversion result for the respective input channel exceeds the value set in the ALERT_HIGH_THRESHOLD register. This fault bit is sticky and remains set until the register is read. 0: no alert indication. 1: alert indication. | 0x0 | R |
| 0 | AL_A_LOW | Alert A Low. The alert indication low bits indicate if a conversion result for the respective input channel exceeds the value set in the ALERT_LOW_THRESHOLD register. This fault bit is sticky and remains set until the register is read. 0: no alert indication. 1: alert indication. | 0x0 | R |

ALERT_LOW_THRESHOLD REGISTER

Address: 0x4, Reset: 0x0800, Name: ALERT_LOW_THRESHOLD

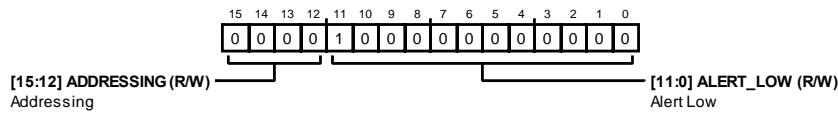

Table 20. Bit Descriptions for ALERT_LOW_THRESHOLD

| Bits | Bit Name | Description | Reset | Access |
|---------|------------|---|-------|--------|
| [15:12] | ADDRESSING | Addressing. Bits[15:12] define the address of the relevant register. See the Addressing Registers section for further details. | 0x0 | R/W |
| [11:0] | ALERT_LOW | Alert Low. Data Bits[D11:D0] are the MSBs of the 16-bit internal alert low register. The remaining 4 bits are fixed at 0x0, which sets an alert when the conversion result is below the ALERT_LOW_THRESHOLD and disables when the conversion result is above the ALERT_LOW_THRESHOLD. | 0x800 | R/W |

ALERT_HIGH_THRESHOLD REGISTER

Address: 0x5, Reset: 0x07FF, Name: ALERT_HIGH_THRESHOLD

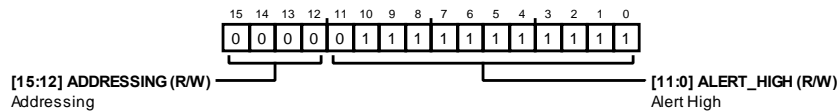
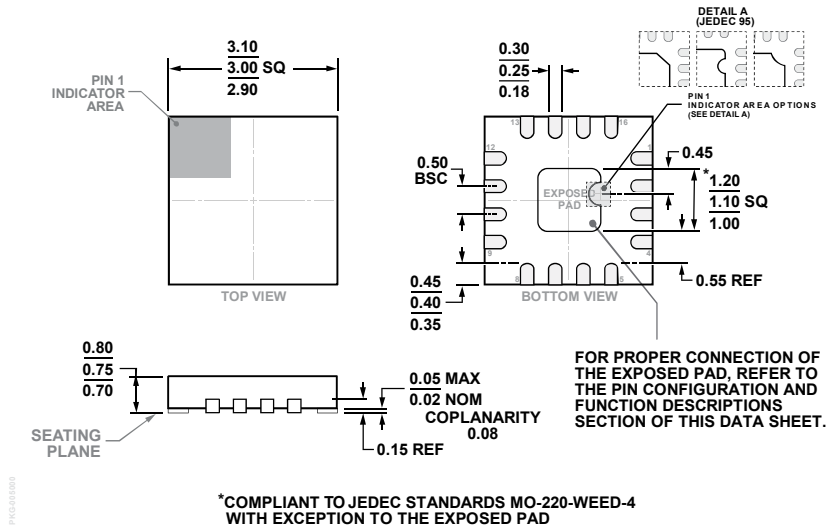

Table 21. Bit Descriptions for ALERT_HIGH_THRESHOLD

| Bits | Bit Name | Description | Reset | Access |
|---------|------------|---|-------|--------|
| [15:12] | ADDRESSING | Addressing. Bits[15:12] define the address of the relevant register. See the Addressing Registers section for further details. | 0x0 | R/W |
| [11:0] | ALERT_HIGH | Alert High. Data Bits[D11:D0] are the MSBs of the 16-bit internal ALERT_HIGH register. The remaining bits are fixed at 0xF, which sets an alert when the converter result is above the ALERT_HIGH_THRESHOLD and disables when the converter result is below the ALERT_HIGH_THRESHOLD. | 0x7FF | R/W |

OUTLINE DIMENSIONS



*COMPLIANT TO JEDEC STANDARDS MO-220-WEED-4 WITH EXCEPTION TO THE EXPOSED PAD
 Figure 44. 16-Lead Lead Frame Chip Scale Package [LFCSP]
 3 mm × 3 mm Body and 0.75 mm Package Height
 (CP-16-45)
 Dimensions shown in millimeters

ORDERING GUIDE

| Model ^{1,2} | Resolution (Bit) | Temperature Range | Package Description | Package Option | Marking Code |
|----------------------|------------------|-------------------|-------------------------|----------------|--------------|
| AD7380BCPZ-RL | 16 | -40°C to +125°C | 16-Lead LFCSP | CP-16-45 | C95 |
| AD7380BCPZ-RL7 | 16 | -40°C to +125°C | 16-Lead LFCSP | CP-16-45 | C95 |
| AD7380BCPZ-R2 | 16 | -40°C to +125°C | 16-Lead LFCSP | CP-16-45 | C95 |
| AD7381BCPZ-RL | 14 | -40°C to +125°C | 16-Lead LFCSP | CP-16-45 | C93 |
| AD7381BCPZ-RL7 | 14 | -40°C to +125°C | 16-Lead LFCSP | CP-16-45 | C93 |
| EVAL-AD7380FMCZ | | | AD7380 Evaluation Board | | |
| EVAL-AD7381FMCZ | | | AD7381 Evaluation Board | | |

¹ Z = RoHS Compliant Part.

² The EVAL-AD7380FMCZ and the EVAL-AD7381FMCZ are compatible with the EVAL-SDP-CH1Z high speed controller board.

Компания «Life Electronics» занимается поставками электронных компонентов импортного и отечественного производства от производителей и со складов крупных дистрибьюторов Европы, Америки и Азии.

С конца 2013 года компания активно расширяет линейку поставок компонентов по направлению коаксиальный кабель, кварцевые генераторы и конденсаторы (керамические, пленочные, электролитические), за счёт заключения дистрибьюторских договоров

Мы предлагаем:

- Конкурентоспособные цены и скидки постоянным клиентам.
- Специальные условия для постоянных клиентов.
- Подбор аналогов.
- Поставку компонентов в любых объемах, удовлетворяющих вашим потребностям.
- Приемлемые сроки поставки, возможна ускоренная поставка.
- Доставку товара в любую точку России и стран СНГ.
- Комплексную поставку.
- Работу по проектам и поставку образцов.
- Формирование склада под заказчика.
- Сертификаты соответствия на поставляемую продукцию (по желанию клиента).
- Тестирование поставляемой продукции.
- Поставку компонентов, требующих военную и космическую приемку.
- Входной контроль качества.
- Наличие сертификата ISO.

В составе нашей компании организован Конструкторский отдел, призванный помогать разработчикам, и инженерам.

Конструкторский отдел помогает осуществить:

- Регистрацию проекта у производителя компонентов.
- Техническую поддержку проекта.
- Защиту от снятия компонента с производства.
- Оценку стоимости проекта по компонентам.
- Изготовление тестовой платы монтаж и пусконаладочные работы.



Тел: +7 (812) 336 43 04 (многоканальный)

Email: org@lifeelectronics.ru