

# 2GHz to 14GHz Microwave Mixer with Integrated LO Frequency Doubler

## FEATURES

- Upconversion or Downconversion
- High IIP3: +28.2dBm at 5.8GHz  
+22.8dBm at 12GHz
- 8.0dB Conversion Loss at 5.8GHz
- +14.3dBm Input P1dB at 5.8GHz
- Integrated LO Buffer: 0dBm LO Drive
- Bypassable Integrated LO Frequency Doubler
- Low LO-RF Leakage: <-30dBm
- 50Ω Single-Ended RF, LO and IF Ports
- 3.3V/115mA Supply
- Fast Turn ON/OFF for TDD Operation
- 2mm × 3mm, 12-Lead QFN Package

## APPLICATIONS

- Microwave Transceivers
- Wireless Backhaul
- Point-to-Point Microwave
- Phased-Array Antennas
- C, X and Ku Band RADAR
- Test Equipment
- Satellite MODEMs

## DESCRIPTION

The **LTC<sup>®</sup>5549** is a general purpose passive double-balanced mixer that can be used for upconversion or downconversion. The RF port is designed for the 2GHz to 14GHz band and the IF port is optimized for 500MHz to 6GHz operation. An integrated LO buffer amplifier supports LO frequencies from 1GHz to 12GHz, requiring only 0dBm LO power. The LTC5549 delivers high IIP3 and input P1dB with low power consumption.

An internal LO frequency doubler can be enabled by a CMOS-compatible digital control pin, allowing operation with a lower, one-half LO input frequency. This allows the mixer's LO port to be used with existing synthesizers, such as the LTC6946 and LTC6948 family.

The LTC5549's high level of integration minimizes the total solution cost, board space and system level variation with its 2mm × 3mm package size.

LT, LTC, LTM, Linear Technology and the Linear logo are registered trademarks of Linear Technology Corporation. All other trademarks are the property of their respective owners.

## TYPICAL APPLICATION

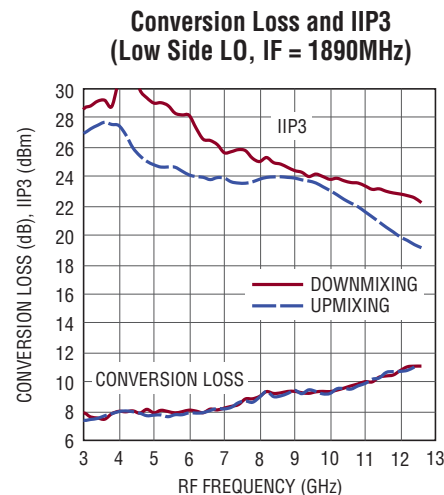
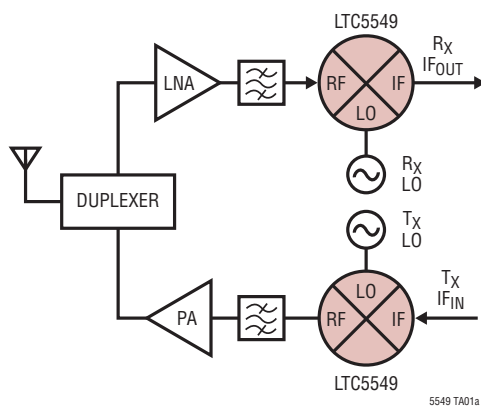

## ABSOLUTE MAXIMUM RATINGS

(Note 1)

|                                       |                          |
|---------------------------------------|--------------------------|
| Supply Voltage ( $V_{CC}$ )           | 4V                       |
| Enable Input Voltage (EN)             | -0.3V to $V_{CC} + 0.3V$ |
| X2 Input Voltage (X2)                 | -0.3V to $V_{CC} + 0.3V$ |
| LO Input Power (1GHz to 12GHz)        | +10dBm                   |
| LO Input DC Voltage                   | $\pm 0.1V$               |
| RF Power (2GHz to 14GHz)              | +20dBm                   |
| RF DC Voltage                         | $\pm 0.1V$               |
| IF Power (0.5GHz to 6GHz)             | +20dBm                   |
| IF DC Voltage                         | $\pm 0.1V$               |
| Operating Temperature Range ( $T_C$ ) | -40°C to 105°C           |
| Storage Temperature Range             | -65°C to 150°C           |
| Junction Temperature ( $T_J$ )        | 150°C                    |

## PIN CONFIGURATION

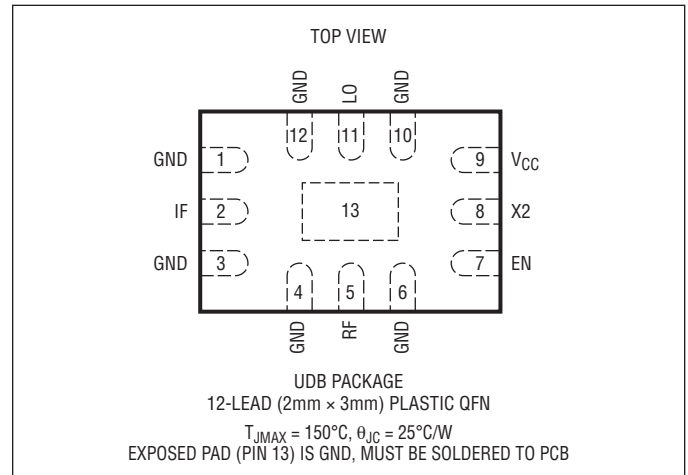

## ORDER INFORMATION

### Lead Free Finish

| TAPE AND REEL (MINI) | TAPE AND REEL     | PART MARKING* | PACKAGE DESCRIPTION             | TEMPERATURE RANGE |
|----------------------|-------------------|---------------|---------------------------------|-------------------|
| LTC5549IUDB#TRMPBF   | LTC5549IUDB#TRPBF | LGTZ          | 12-Lead (2mm x 3mm) Plastic QFN | -40°C to 105°C    |

TRM = 500 pieces. \*Temperature grades are identified by a label on the shipping container.

Consult LTC Marketing for parts specified with wider operating temperature ranges.

Consult LTC Marketing for information on lead based finish parts.

For more information on lead free part marking, go to: <http://www.linear.com/leadfree/>

For more information on tape and reel specifications, go to: <http://www.linear.com/tapeand reel/>

## DC ELECTRICAL CHARACTERISTICS

The ● denotes the specifications which apply over the full operating temperature range, otherwise specifications are at  $T_C = 25^\circ\text{C}$ .  $V_{CC} = 3.3V$ , EN = High, unless otherwise noted. Test circuit shown in Figure 1. (Note 2)

| PARAMETER   | CONDITIONS               | MIN   | TYP | MAX | UNITS         |
|---|--------------------------|-------|-----|-----|---------------|
| <b>Power Supply Requirements</b>                              |                          |       |     |     |               |
| Supply Voltage ( $V_{CC}$ )                                   |                          | ● 3.0 | 3.3 | 3.6 | V             |
| Supply Current Enabled  | EN = High, X2 = Low      |       | 115 | 136 | mA            |
|   | EN = High, X2 = High     |       | 130 | 155 | mA            |
| Disabled  | EN = Low                 |       |     | 100 | $\mu\text{A}$ |
| <b>Enable (EN) and LO Frequency Doubler (X2) Logic Inputs</b> |                          |       |     |     |               |
| Input High Voltage (On)                                       |                          | ● 1.2 |     |     | V             |
| Input Low Voltage (Off)                                       |                          | ●     |     | 0.3 | V             |
| Input Current   | -0.3V to $V_{CC} + 0.3V$ | -30   |     | 100 | $\mu\text{A}$ |
| Chip Turn-On Time   |                          |       | 0.2 |     | $\mu\text{s}$ |
| Chip Turn-Off Time  |                          |       | 0.1 |     | $\mu\text{s}$ |

**AC ELECTRICAL CHARACTERISTICS** The ● denotes the specifications which apply over the full operating temperature range, otherwise specifications are at  $T_C = 25^\circ\text{C}$ .  $V_{CC} = 3.3\text{V}$ ,  $EN = \text{High}$ ,  $P_{LO} = 0\text{dBm}$ ,  $P_{RF} = -5\text{dBm}$  ( $-5\text{dBm}/\text{tone}$  for two-tone IIP3 tests), unless otherwise noted. Test circuit shown in Figure 1. (Notes 2, 3)

| PARAMETER            | CONDITIONS                         | MIN | TYP         | MAX | UNITS |
|----------------------|------------------------------------|-----|-------------|-----|-------|
| LO Frequency Range   | ●                                  |     | 1 to 12     |     | GHz   |
| RF Frequency Range   | ●                                  |     | 2 to 14     |     | GHz   |
| IF Frequency Range   | ●                                  |     | 500 to 6000 |     | MHz   |
| RF Return Loss       | $Z_0 = 50\Omega$ , 2GHz to 13.6GHz |     | >9          |     | dB    |
| LO Input Return Loss | $Z_0 = 50\Omega$ , 1GHz to 12GHz   |     | >10         |     | dB    |
| IF Return Loss       | $Z_0 = 50\Omega$ , 0.7GHz to 6GHz  |     | >10         |     | dB    |
| LO Input Power       | $X2 = \text{Low}$                  | -6  | 0           | 6   | dBm   |
|                      | $X2 = \text{High}$                 | -6  | 0           | 3   | dBm   |

#### Downmixer Application with LO Doubler Off ( $X2 = \text{Low}$ )

|  |   |   |                              |  |                          |
|--|---|---|------------------------------|--|--------------------------|
| Conversion Loss  | RF Input = 2GHz, LO = 3.89GHz<br>RF Input = 5.8GHz, LO = 3.91GHz<br>RF Input = 9GHz, LO = 7.11GHz<br>RF Input = 12GHz, LO = 10.11GHz  |   | 7.8<br>8.0<br>9.4<br>10.8    |  | dB<br>dB<br>dB<br>dB     |
| Conversion Loss vs Temperature                                     | $T_C = -40^\circ\text{C}$ to $105^\circ\text{C}$ , RF Input = 5.8GHz  | ● | 0.009                        |  | dB/ $^\circ\text{C}$     |
| 2-Tone Input 3rd Order Intercept ( $\Delta f_{RF} = 2\text{MHz}$ ) | RF Input = 2GHz, LO = 3.89GHz<br>RF Input = 5.8GHz, LO = 3.91GHz<br>RF Input = 9GHz, LO = 7.11GHz<br>RF Input = 12GHz, LO = 10.11GHz  |   | 26.0<br>28.2<br>24.4<br>22.8 |  | dBm<br>dBm<br>dBm<br>dBm |
| SSB Noise Figure   | RF Input = 2GHz, LO = 3.89GHz<br>RF Input = 5.8GHz, LO = 3.91GHz<br>RF Input = 8.5GHz, LO = 6.61GHz<br>RF Input = 10GHz, LO = 8.11GHz |   | 7.9<br>8.1<br>10.2<br>10.4   |  | dB<br>dB<br>dB<br>dB     |
| LO to RF Leakage   | $f_{LO} = 1\text{GHz}$ to 12GHz   |   | <-30                         |  | dBm                      |
| LO to IF Leakage   | $f_{LO} = 1\text{GHz}$ to 12GHz   |   | <-27                         |  | dBm                      |
| RF to LO Isolation   | $f_{RF} = 2\text{GHz}$ to 14GHz   |   | >45                          |  | dB                       |
| RF Input to IF Output Isolation                                    | $f_{RF} = 2\text{GHz}$ to 14GHz   |   | >35                          |  | dB                       |
| Input 1dB Compression  | RF Input = 5.8GHz, LO = 3.91GHz   |   | 14.3                         |  | dBm                      |

#### Downmixer Application with LO Doubler On ( $X2 = \text{High}$ )

|  |   |   |                      |  |                      |
|--|---|---|----------------------|--|----------------------|
| Conversion Loss  | RF Input = 5.8GHz, LO = 1.955GHz<br>RF Input = 9GHz, LO = 3.555GHz<br>RF Input = 12GHz, LO = 5.055GHz   |   | 8.2<br>9.9<br>11.9   |  | dB<br>dB<br>dB       |
| Conversion Loss vs. Temperature                                    | $T_C = -40^\circ\text{C}$ to $105^\circ\text{C}$ , RF Input = 5.8GHz                                    | ● | 0.009                |  | dB/ $^\circ\text{C}$ |
| 2-Tone Input 3rd Order Intercept ( $\Delta f_{RF} = 2\text{MHz}$ ) | RF Input = 5.8GHz, LO = 1.955GHz<br>RF Input = 9GHz, LO = 3.555GHz<br>RF Input = 12GHz, LO = 5.055GHz   |   | 27.9<br>24.8<br>22.0 |  | dBm<br>dBm<br>dBm    |
| SSB Noise Figure   | RF Input = 5.8GHz, LO = 1.955GHz<br>RF Input = 8.5GHz, LO = 3.305GHz<br>RF Input = 10GHz, LO = 4.055GHz |   | 9.6<br>10.7<br>12.6  |  | dB<br>dB<br>dB       |
| LO to RF Input Leakage   | $f_{LO} = 1\text{GHz}$ to 5GHz  |   | <-35                 |  | dBm                  |
| 2LO to RF Input Leakage  | $f_{LO} = 1\text{GHz}$ to 5GHz  |   | $\leq -28$           |  | dBm                  |
| LO to IF Output Leakage  | $f_{LO} = 1\text{GHz}$ to 5GHz  |   | <-30                 |  | dBm                  |
| 2LO to IF Output Leakage   | $f_{LO} = 1\text{GHz}$ to 5GHz  |   | <-31                 |  | dBm                  |
| Input 1dB Compression  | $f_{RF} = 5.8\text{GHz}$ , $f_{LO} = 1.955\text{GHz}$   |   | 13.8                 |  | dBm                  |

**AC ELECTRICAL CHARACTERISTICS** The ● denotes the specifications which apply over the full operating temperature range, otherwise specifications are at  $T_C = 25^\circ\text{C}$ .  $V_{CC} = 3.3\text{V}$ ,  $EN = \text{High}$ ,  $P_{LO} = 0\text{dBm}$ ,  $P_{IF} = -5\text{dBm}$  ( $-5\text{dBm/tone}$  for two-tone IIP3 tests), unless otherwise noted. Test circuit shown in Figure 1. (Notes 2, 3)

| PARAMETER  | CONDITIONS  | MIN | TYP   | MAX | UNITS                |
|--|---|-----|-------|-----|----------------------|
| <b>Upmixer Application with LO Doubler Off (X2 = Low)</b>          |   |     |       |     |                      |
| Conversion Loss  | RF Output = 2GHz, LO = 3.89GHz  |     | 7.7   |     | dB                   |
|  | RF Output = 5.8GHz, LO = 3.91GHz                                      |     | 7.8   |     | dB                   |
|  | RF Output = 9GHz, LO = 7.11GHz  |     | 9.2   |     | dB                   |
|  | RF Output = 12GHz, LO = 10.11GHz                                      |     | 10.7  |     | dB                   |
| Conversion Loss vs Temperature                                     | $T_C = -40^\circ\text{C}$ to $105^\circ\text{C}$ , RF Output = 5.8GHz |     | 0.009 |     | dB/ $^\circ\text{C}$ |
| Input 3rd Order Intercept ( $\Delta f_{IF} = 2\text{MHz}$ )        | RF Output = 2GHz, LO = 3.89GHz  |     | 25.0  |     | dBm                  |
|  | RF Output = 5.8GHz, LO = 3.91GHz                                      |     | 24.4  |     | dBm                  |
|  | RF Output = 9GHz, LO = 7.11GHz  |     | 23.9  |     | dBm                  |
|  | RF Output = 12GHz, LO = 10.11GHz                                      |     | 19.9  |     | dBm                  |
| SSB Noise Figure   | RF Output = 2GHz, LO = 3.89GHz  |     | 7.8   |     | dB                   |
|  | RF Output = 5.8GHz, LO = 3.91GHz                                      |     | 8.8   |     | dB                   |
|  | RF Output = 8.5GHz, LO = 6.61GHz                                      |     | 10.4  |     | dB                   |
|  | RF Output = 10GHz, LO = 8.11GHz                                       |     | 11.1  |     | dB                   |
| LO to RF Output Leakage  | $f_{LO} = 1\text{GHz}$ to $12\text{GHz}$                              |     | <-30  |     | dBm                  |
| LO to IF Input Leakage   | $f_{LO} = 1\text{GHz}$ to $12\text{GHz}$                              |     | <-27  |     | dBm                  |
| IF to LO Isolation   | $f_{IF} = 500\text{MHz}$ to $6\text{GHz}$                             |     | >45   |     | dB                   |
| IF to RF Isolation   | $f_{IF} = 500\text{MHz}$ to $6\text{GHz}$                             |     | >40   |     | dB                   |
| Input 1dB Compression  | RF Output = 5.8GHz, LO = 3.91GHz                                      |     | 15.5  |     | dBm                  |
| <b>Upmixer Application with LO Doubler On (X2 = High)</b>          |   |     |       |     |                      |
| Conversion Loss  | RF Output = 5.8GHz, LO = 1.955GHz                                     |     | 8.1   |     | dB                   |
|  | RF Output = 9GHz, LO = 3.555GHz                                       |     | 9.7   |     | dB                   |
|  | RF Output = 12GHz, LO = 5.055GHz                                      |     | 11.8  |     | dB                   |
| Conversion Loss vs Temperature                                     | $T_C = -40^\circ\text{C}$ to $105^\circ\text{C}$ , RF Output = 5.8GHz |     | 0.009 |     | dB/ $^\circ\text{C}$ |
| 2-Tone Input 3rd Order Intercept ( $\Delta f_{IF} = 2\text{MHz}$ ) | RF Output = 5.8GHz, LO = 1.955GHz                                     |     | 23.2  |     | dBm                  |
|  | RF Output = 9GHz, LO = 3.555GHz                                       |     | 23.5  |     | dBm                  |
|  | RF Output = 12GHz, LO = 5.055GHz                                      |     | 20.0  |     | dBm                  |
| SSB Noise Figure   | RF Output = 5.8GHz, LO = 1.955GHz                                     |     | 10.9  |     | dB                   |
|  | RF Output = 9GHz, LO = 3.555GHz                                       |     | 12.3  |     | dB                   |
|  | RF Output = 10GHz, LO = 4.055GHz                                      |     | 12.7  |     | dB                   |
| LO to RF Output Leakage  | $f_{LO} = 1\text{GHz}$ to $5\text{GHz}$                               |     | <-35  |     | dBm                  |
| 2LO to RF Output Leakage   | $f_{LO} = 1\text{GHz}$ to $5\text{GHz}$                               |     | <-30  |     | dBm                  |
| LO to IF Input Leakage   | $f_{LO} = 1\text{GHz}$ to $5\text{GHz}$                               |     | <-30  |     | dBm                  |
| 2LO to IF Input Leakage  | $f_{LO} = 1\text{GHz}$ to $5\text{GHz}$                               |     | <-31  |     | dBm                  |
| Input 1dB Compression  | RF Output = 5.8GHz, LO = 1.955GHz                                     |     | 15.4  |     | dBm                  |

**Note 1:** Stresses beyond those listed under Absolute Maximum Ratings may cause permanent damage to the device. Exposure to any Absolute Maximum Rating condition for extended periods may affect device reliability and lifetime.

**Note 2:** The LTC5549 is guaranteed functional over the  $-40^\circ\text{C}$  to  $105^\circ\text{C}$  case temperature range ( $\theta_{JC} = 25^\circ\text{C/W}$ ).

**Note 3:** SSB noise figure measurements performed with a small-signal noise source, bandpass filter and 2dB matching pad on input, with bandpass filters on LO, and output.

**TYPICAL PERFORMANCE CHARACTERISTICS** EN = high, test circuit shown in Figure 1.

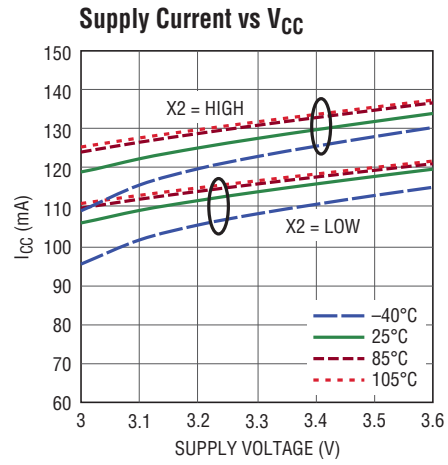
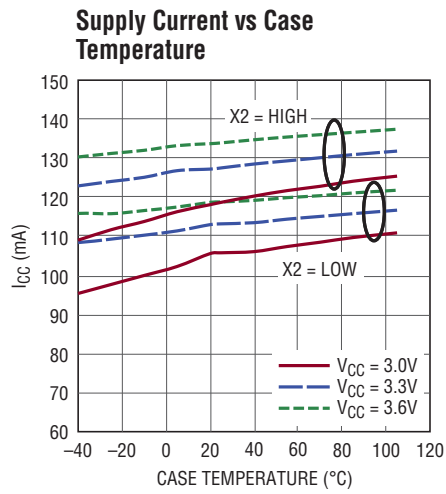

## TYPICAL PERFORMANCE CHARACTERISTICS 2GHz to 13GHz downmixer application.

$V_{CC} = 3.3V$ ,  $EN = \text{high}$ ,  $X2 = \text{low}$ ,  $T_C = 25^\circ C$ ,  $P_{LO} = 0\text{dBm}$ ,  $P_{RF} = -5\text{dBm}$  ( $-5\text{dBm}/\text{tone}$  for two-tone IIP3 tests,  $\Delta f = 2\text{MHz}$ ),  $IF = 1.89\text{GHz}$ , unless otherwise noted. Test circuit shown in Figure 1.

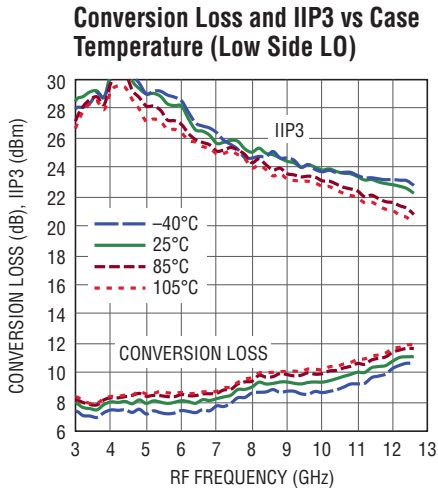

5549 G03

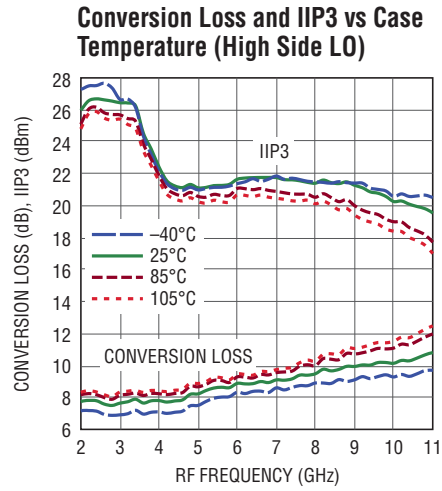

5549 G04

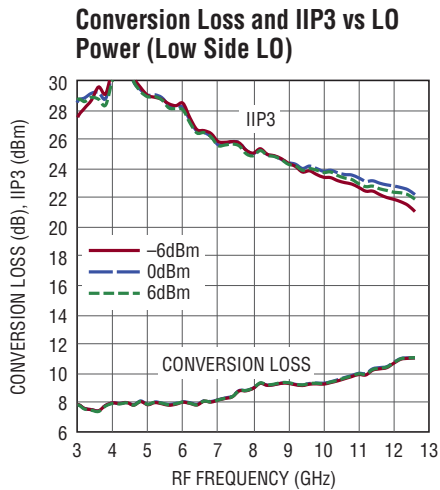

5549 G05

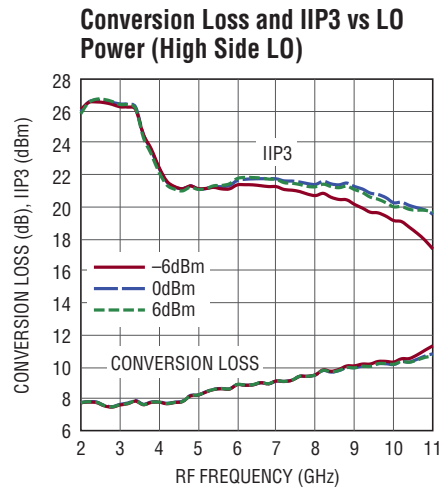

5549 G06

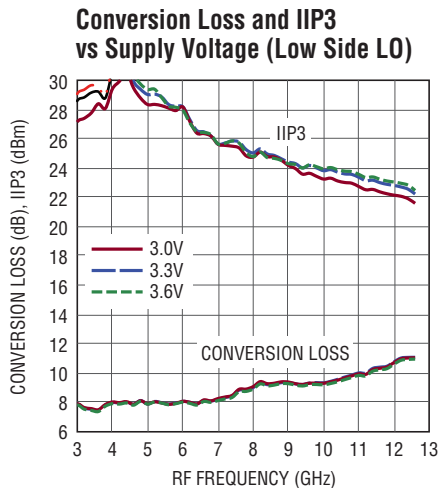

5549 G07

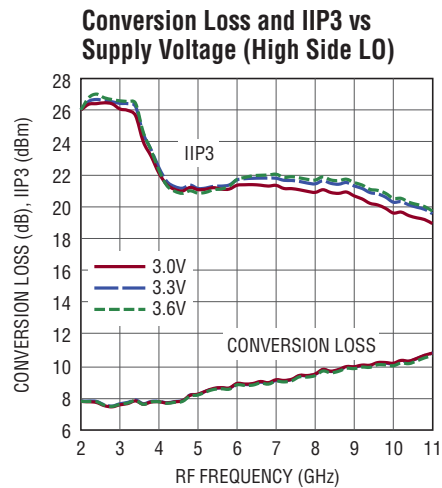

5549 G08

**TYPICAL PERFORMANCE CHARACTERISTICS** 2GHz to 13GHz downmixer application.  
 $V_{CC} = 3.3V$ , EN = high, X2 = low,  $T_C = 25^\circ C$ ,  $P_{LO} = 0dBm$ ,  $P_{RF} = -5dBm$  (-5dBm/tone for two-tone IIP3 tests,  $\Delta f = 2MHz$ ), IF = 1.89GHz, unless otherwise noted. Test circuit shown in Figure 1.

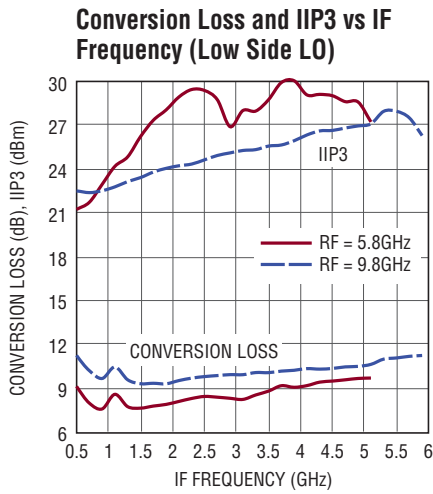

5549 G09

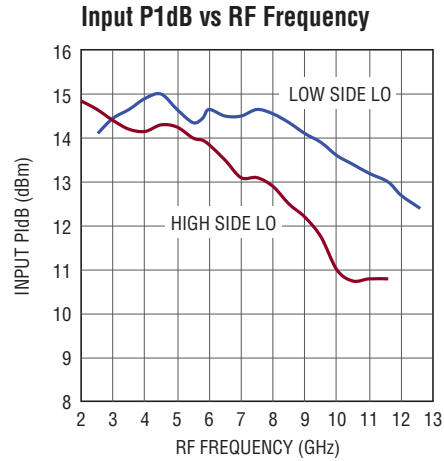

5549 G10

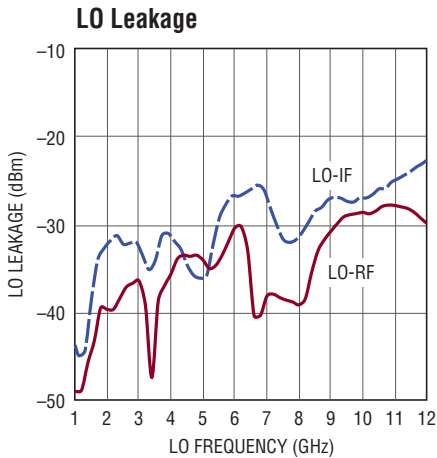

5549 G11

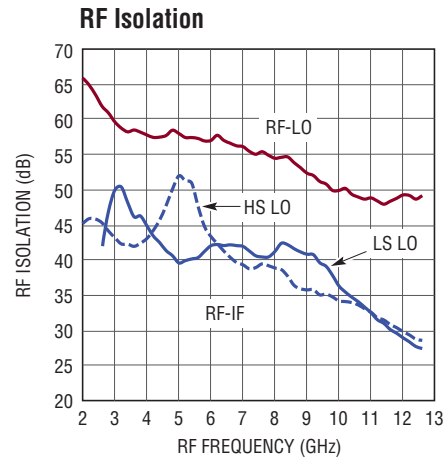

5549 G12

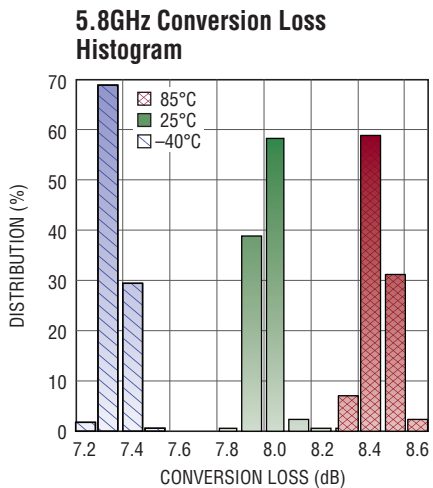

5549 G13

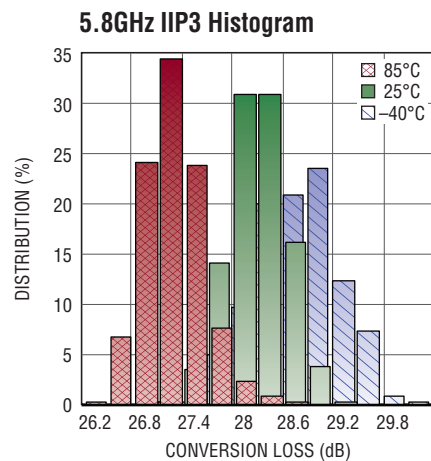

5549 G14

**TYPICAL PERFORMANCE CHARACTERISTICS** 2GHz to 13GHz downmixer application with LO frequency doubler enabled.  $V_{CC} = 3.3V$ , EN = high, X2 = high,  $T_C = 25^\circ C$ ,  $P_{LO} = 0dBm$ ,  $P_{RF} = -5dBm$  (-5dBm/tone for two-tone IIP3 tests,  $\Delta f = 2MHz$ ),  $IF = 1.89GHz$ , unless otherwise noted. Test circuit shown in Figure 1.

**Conversion Loss and IIP3 vs Case Temperature (Low Side LO)**

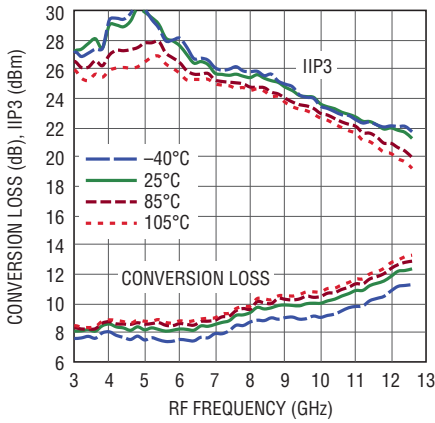

5549 G15

**Conversion Loss and IIP3 vs LO Power (Low Side LO)**

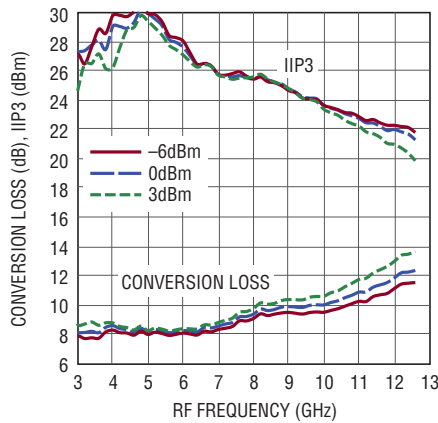

5549 G16

**Conversion Loss and IIP3 vs Supply Voltage (Low Side LO)**

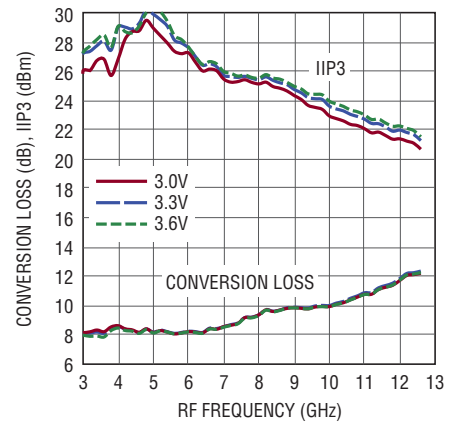

5549 G17

**Conversion Loss and IIP3 vs Case Temperature (High Side LO)**

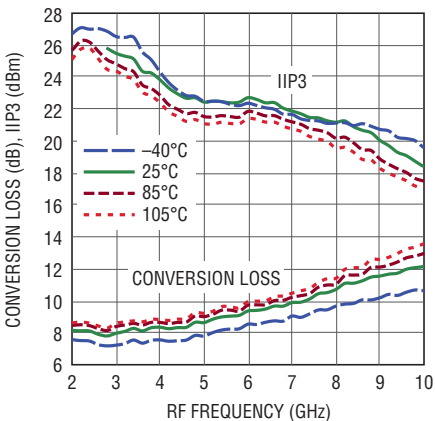

5549 G18

**Conversion Loss and IIP3 vs LO Power (High Side LO)**

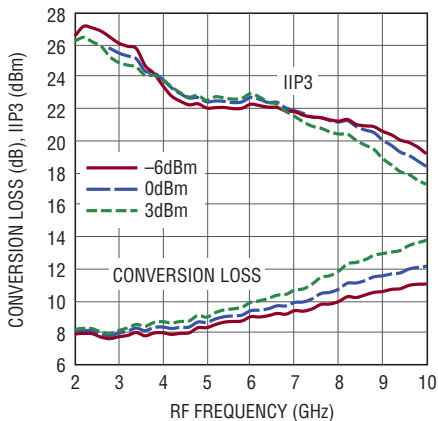

5549 G19

**Conversion Loss and IIP3 vs Supply Voltage (High Side LO)**

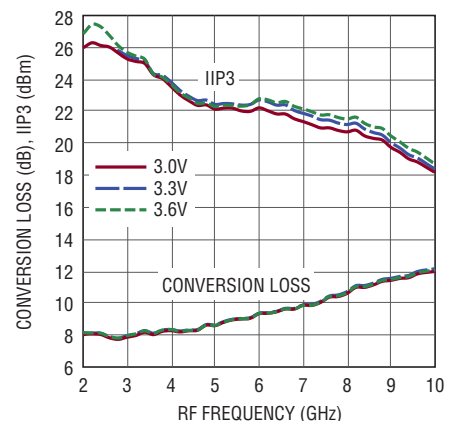

5549 G20

**Conversion Loss and IIP3 vs IF Frequency (Low Side LO)**

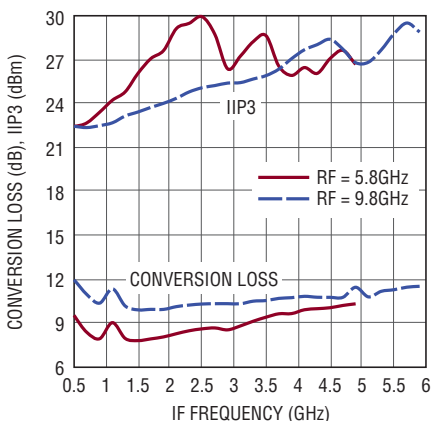

5549 G21

**Input P1dB vs RF Frequency**

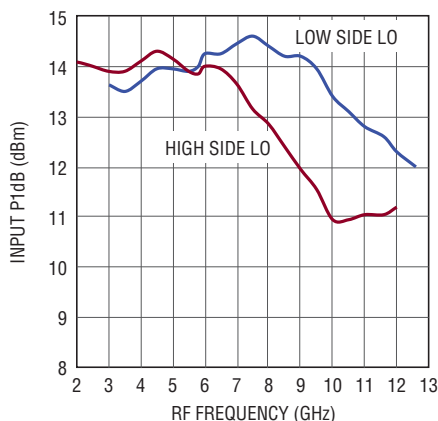

5549 G22

**LO and 2LO Leakage to IF**

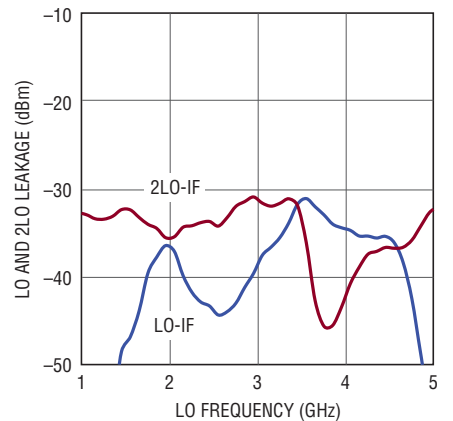

5549 G23

5549fa



**TYPICAL PERFORMANCE CHARACTERISTICS** 2GHz to 13GHz upmixer application.  
 $V_{CC} = 3.3V$ ,  $EN = \text{high}$ ,  $X2 = \text{low}$ ,  $T_C = 25^\circ C$ ,  $P_{LO} = 0\text{dBm}$ ,  $P_{IF} = -5\text{dBm}$  (-5dBm/tone for two-tone IIP3 tests,  $\Delta f = 2\text{MHz}$ ),  $IF = 1.89\text{GHz}$ , unless otherwise noted. Test circuit shown in Figure 1.

**Conversion Loss and IIP3 vs Case Temperature (Low Side LO)**

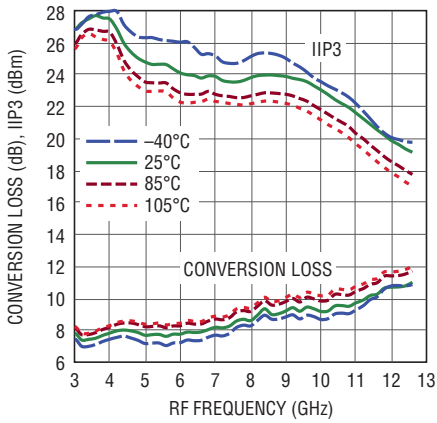

5549 G24

**Conversion Loss and IIP3 vs LO Power (Low Side LO)**

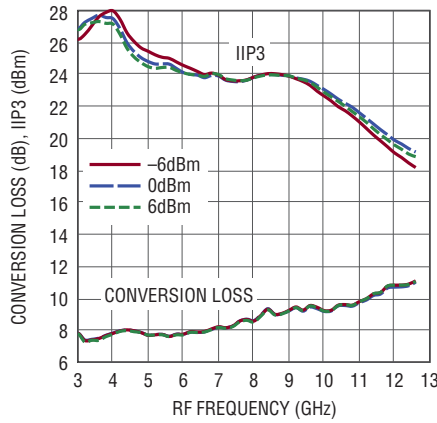

5549 G25

**Conversion Loss and IIP3 vs Supply Voltage (Low Side LO)**

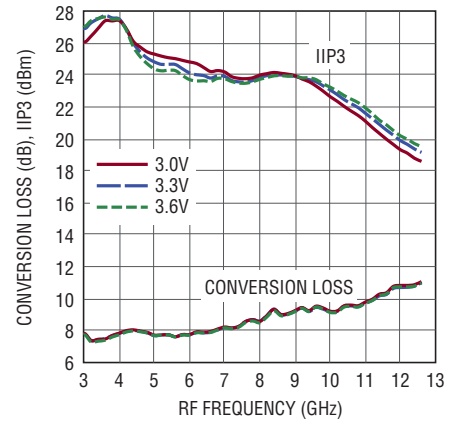

5549 G26

**Conversion Loss and IIP3 vs Case Temperature (High Side LO)**

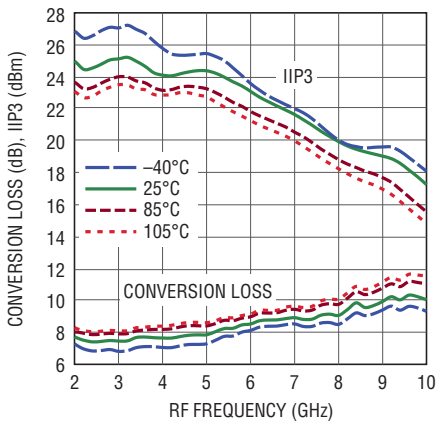

5549 G27

**Conversion Loss and IIP3 vs LO Power (High Side LO)**

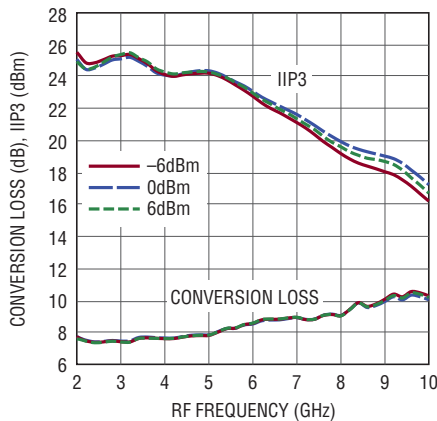

5549 G28

**Conversion Loss and IIP3 vs Supply Voltage (High Side LO)**

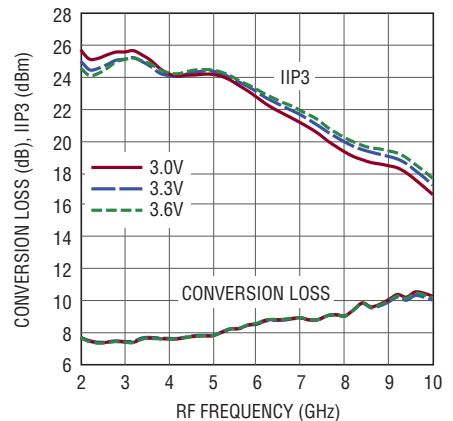

5549 G29

**Conversion Loss and IIP3 vs IF Frequency (Low Side LO)**

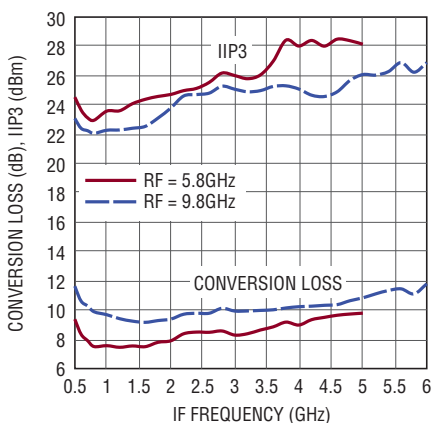

5549 G30

**Input P1dB vs IF Frequency**

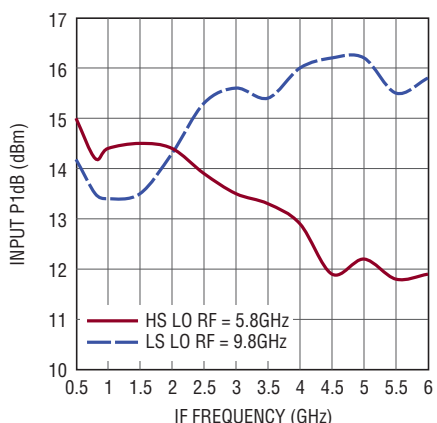

5549 G31

**IF Isolation**

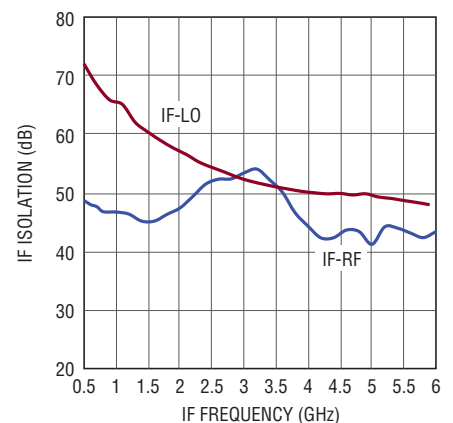

5549 G32

**TYPICAL PERFORMANCE CHARACTERISTICS** 2GHz to 13GHz upmixer application with LO frequency doubler enabled.  $V_{CC} = 3.3V$ , EN = high, X2 = high,  $T_C = 25^\circ C$ ,  $P_{LO} = 0dBm$ ,  $P_{IF} = -5dBm$  (-5dBm/tone for two-tone IIP3 tests,  $\Delta f = 2MHz$ ), output measured at 5.8GHz, unless otherwise noted. Test circuit shown in Figure 1.

**Conversion Loss and IIP3 vs Case Temperature (Low Side LO)**

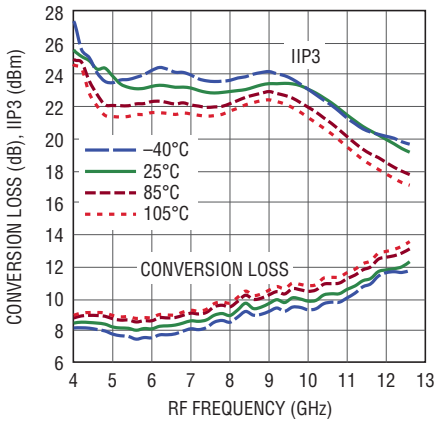

5549 G33

**Conversion Loss and IIP3 vs LO Power (Low Side LO)**

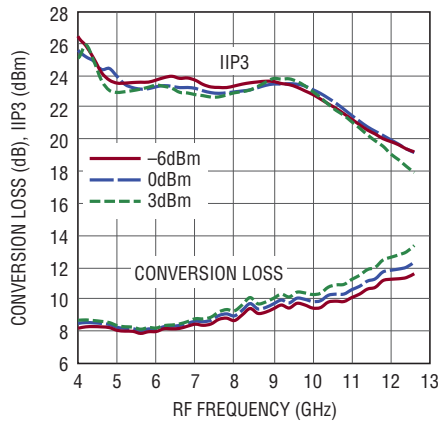

5549 G34

**Conversion Loss and IIP3 vs Supply Voltage (Low Side LO)**

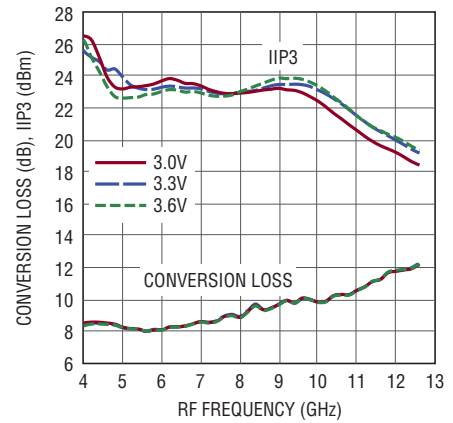

5549 G35

**Conversion Loss and IIP3 vs Case Temperature (High Side LO)**

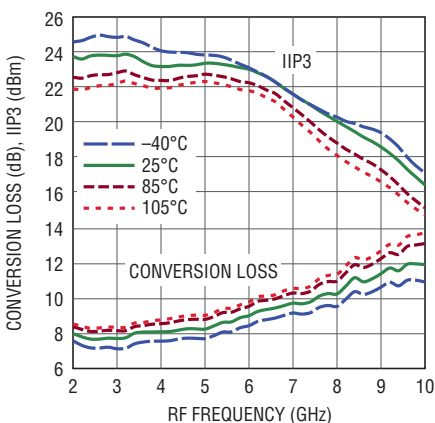

5549 G36

**Conversion Loss and IIP3 vs LO Power (High Side LO)**

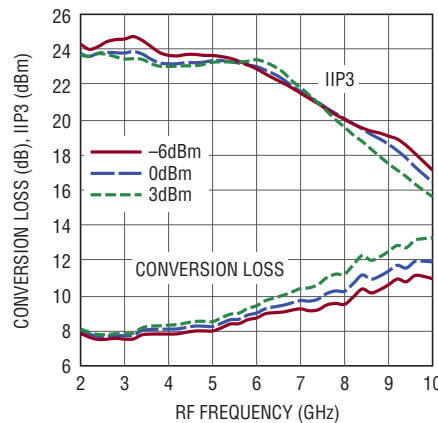

5549 G37

**Conversion Loss and IIP3 vs Supply Voltage (High Side LO)**

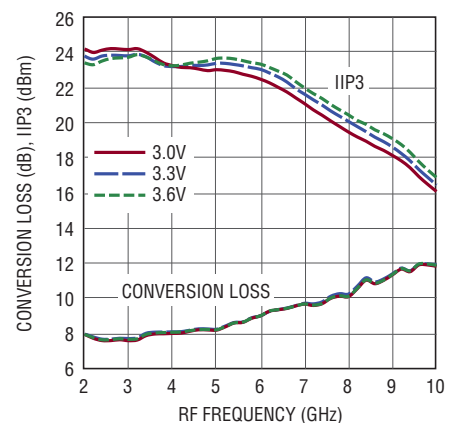

5549 G38

**Conversion Loss and IIP3 vs IF Frequency (Low Side LO)**

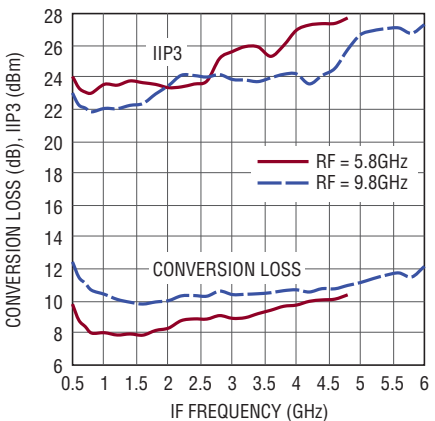

5549 G39

**Input P1dB vs IF Frequency**

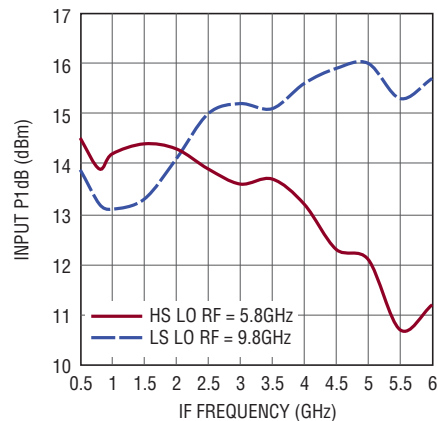

5549 G40

**LO and 2LO Leakage to RF**

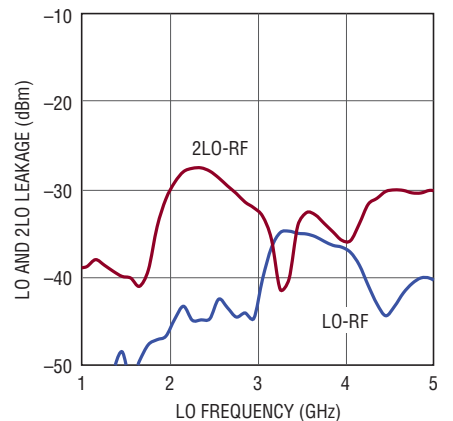

5549 G41

5549fa

## PIN FUNCTIONS

**GND (Pins 1, 3, 4, 6, 10, 12, Exposed Pad Pin 13):** Ground. These pins must be soldered to the RF ground on the circuit board. The exposed pad metal of the package provides both electrical contact to ground and good thermal contact to the printed circuit board.

**IF (Pin 2):** Single-Ended Terminal for the IF Port. This pin is internally connected to the primary side of the IF transformer, which has low DC resistance to ground. A series DC blocking capacitor should be used to avoid damage to the integrated transformer when DC voltage is present. The IF port is impedance matched from 500MHz to 6GHz, as long as the LO is driven with a  $0 \pm 6$ dBm source between 1GHz and 12GHz.

**RF (Pin 5):** Single-Ended Terminal for the RF Port. This pin is internally connected to the primary side of the RF transformer, which has low DC resistance to ground. A series DC blocking capacitor should be used to avoid damage to the integrated transformer when DC voltage is present. The RF port is impedance matched from 2GHz to 14GHz as long as the LO is driven with a  $0 \pm 6$ dBm source between 1GHz and 12GHz.

**EN (Pin 7):** Enable Pin. When the voltage to this pin is greater than 1.2V, the mixer is enabled. When the input voltage is less than 0.3V, the mixer is disabled. Typical current drawn is less than  $30\mu\text{A}$ . This pin has an internal  $376\text{k}\Omega$  pull-down resistor.

**X2 (Pin 8):** Digital Control Pin for LO Frequency Doubler. When the voltage to this pin is greater than 1.2V, the LO frequency doubler is enabled. When the input voltage is less than 0.3V, the LO frequency doubler is disabled. Typical current drawn is less than  $30\mu\text{A}$ . This pin has an internal  $376\text{k}\Omega$  pull-down resistor.

**V<sub>CC</sub> (Pin 9):** Power Supply Pin. This pin must be externally connected to a regulated 3.3V supply, with a bypass capacitor located close to the pin. Typical current consumption is 115mA.

**LO (Pin 11):** Input for the Local Oscillator (LO). The LO signal is applied through this pin. A series DC blocking capacitor should be used. Typical DC voltage at this pin is 1.6V.

**BLOCK DIAGRAM**

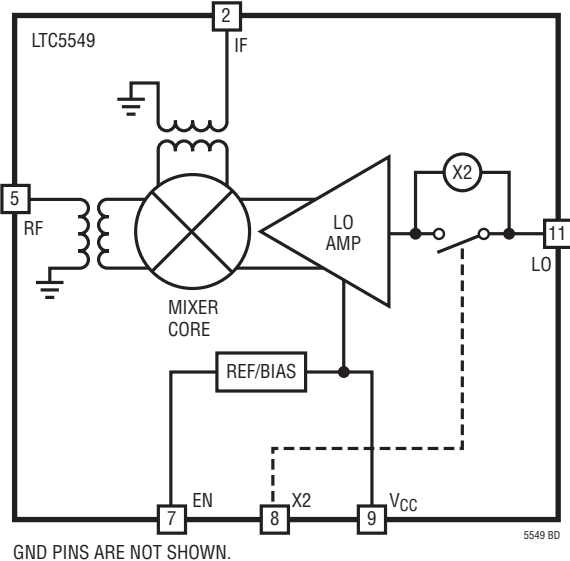

# TEST CIRCUIT

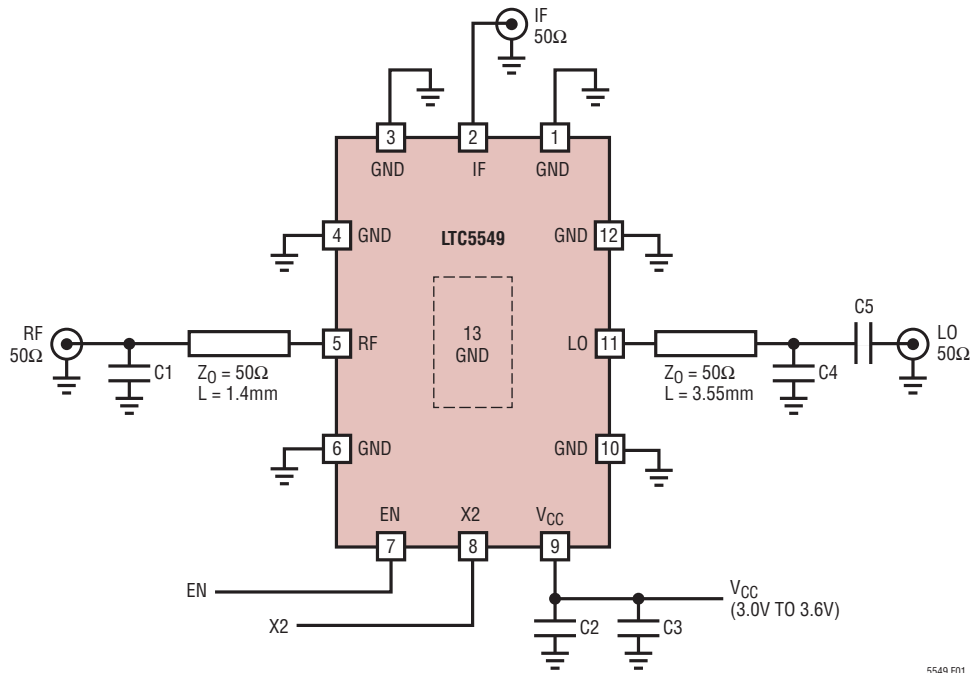

5549 F01

| REF DES | VALUE  | SIZE | VENDOR | COMMENT             |
|---------|--------|------|--------|---------------------|
| C1, C4  | 0.15pF | 0402 | AVX    | ACCU-P 04021JR15ZBS |
| C2, C5  | 22pF   | 0402 | AVX    |                     |
| C3      | 1μF    | 0603 | AVX    |                     |

Figure 1. Standard Test Circuit Schematic

## APPLICATIONS INFORMATION

### Introduction

The LTC5549 consists of a high linearity double-balanced mixer core, LO buffer amplifier, LO frequency doubler and bias/enable circuits. See the Block Diagram section for a description of each pin function. The RF, LO and IF are single-ended terminals. The LTC5549 can be used as a frequency downconverter where the RF is used as an input and IF is used as an output. It can also be used as a frequency upconverter where the IF is used as an input and RF is used as an output. Low side or high side LO injection can be used. The evaluation circuit and the evaluation board layout are shown in Figure 1 and Figure 2, respectively.

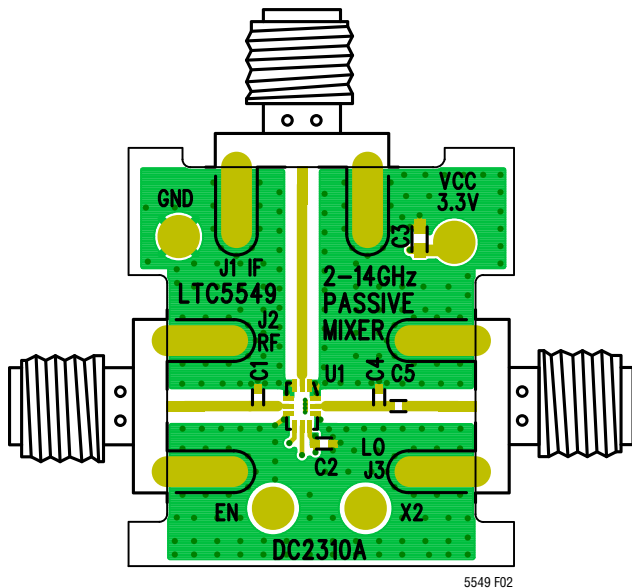

Figure 2. Evaluation Board Layout

### RF Port

The mixer's RF port, shown in Figure 3, is connected to the primary winding of an integrated transformer. The primary side of the RF transformer is DC-grounded internally and the DC resistance of the primary side is approximately  $3.2\Omega$ . A DC blocking capacitor is needed if the RF source has DC voltage present. The secondary winding of the RF transformer is internally connected to the mixer core.

The RF port is broadband matched to  $50\Omega$  from 2GHz to 14GHz with a  $0.15\text{pF}$  shunt capacitor (C1) located 1.4mm away from the RF pin. The RF port is  $50\Omega$  matched from 2GHz to 10GHz without C1. An LO signal between  $-6\text{dBm}$  and  $6\text{dBm}$  is required for good RF impedance matching.

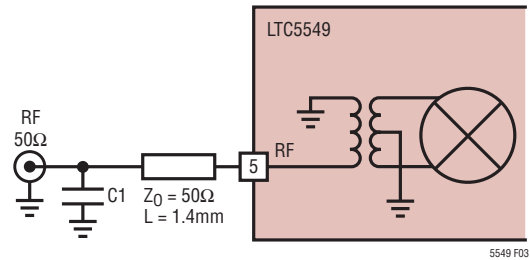
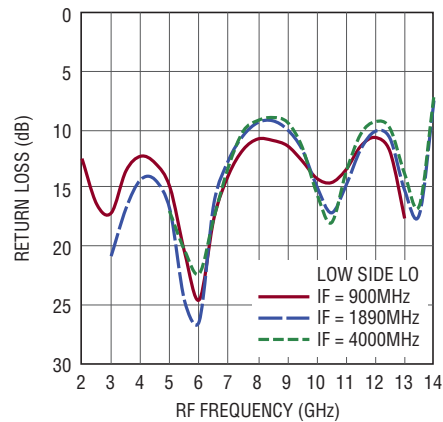
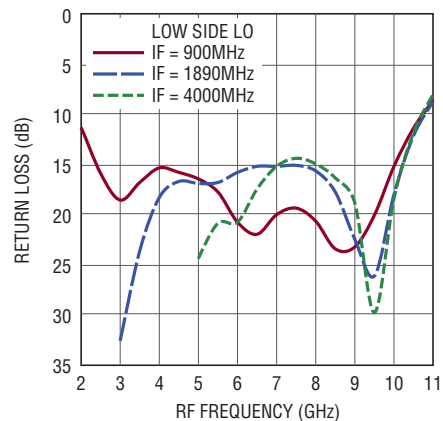

Figure 3. Simplified RF Port Interface Schematic



(a)



(b)

Figure 4. RF Port Return Loss (a)  $C1 = 0.15\text{pF}$  (b)  $C1$  Open

The measured RF input return loss is shown in Figure 4 for IF frequencies of 900MHz, 1890MHz and 4GHz.

### LO Input

The mixer's LO input circuit, shown in Figure 5, consists of a single-ended to differential conversion, high speed

## APPLICATIONS INFORMATION

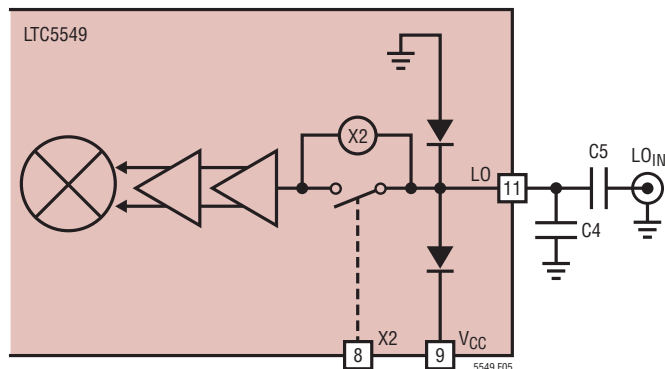

Figure 5. Simplified LO Input Schematic

limiting differential amplifier and an LO frequency doubler. The LTC5549's LO amplifier is optimized for the 1GHz to 12GHz LO frequency range. LO frequencies above or below this frequency range may be used with degraded performance. The LO frequency doubler is controlled by a digital voltage input at X2 (Pin 8). When the X2 voltage is higher than 1.2V, the LO frequency doubler is enabled. When X2 is left open or its voltage is lower than 0.5V, the LO frequency doubler is disabled.

The mixer's LO input is connected to a singled-ended differential buffer and ESD devices. The DC voltage at the LO input is about 1.6V. A DC blocking capacitor is required for the LO circuit to operate properly.

The LO is 50 $\Omega$  matched from 1GHz to 12GHz. With a 0.15pF shunt capacitor (C4) located 3.55mm away from the LO pin. The LO port is 50 $\Omega$  matched from 1GHz to 8.4GHz without C4. External matching components may be needed for extended LO operating frequency range. The measured LO input return loss is shown in Figure 6. The nominal LO input level is 0dBm, although the limiting amplifiers will deliver excellent performance over a  $\pm 6$ dBm input power range.

### IF Port

The mixer's IF port, shown in Figure 7, is connected to the primary winding of an integrated transformer. The primary side of the IF transformer is DC-grounded internally and the DC resistance is approximately 6.2 $\Omega$ . A DC blocking capacitor is needed if the IF source has DC voltage present. The secondary winding of the IF transformer is internally connected to the mixer core.

The IF port is broadband matched to 50 $\Omega$  from 500MHz to 6GHz. An LO signal between -6dBm and 6dBm is required for good IF impedance matching. Frequencies outside of this range can be used with degraded performance.

The measured IF port return loss is shown in Figure 8.

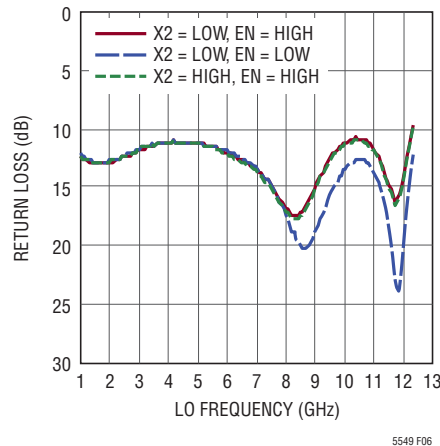

Figure 6. LO Input Return Loss

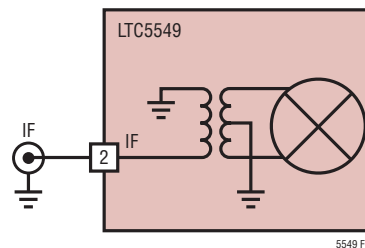

Figure 7. Simplified IF Port Interface Schematic

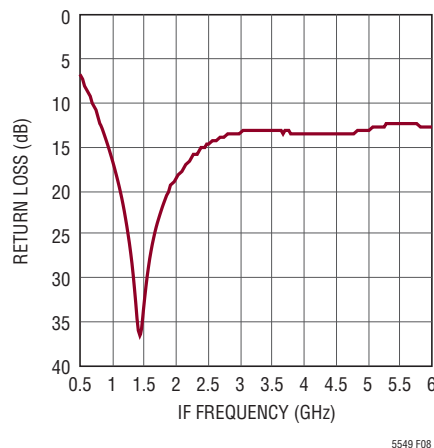

Figure 8. IF Port Return Loss

## APPLICATIONS INFORMATION

### Enable Interface

Figure 9 shows a simplified schematic of the EN pin interface. To enable the chip, the EN voltage must be higher than 1.2V. The voltage at the EN pin should never exceed  $V_{CC}$  by more than 0.3V. If this should occur, the supply current could be sourced through the ESD diode, potentially damaging the IC. If the EN pin is left floating, its voltage will be pulled low by the internal pull-down resistor and the chip will be disabled.

### X2 Interface

Figure 10 shows a simplified schematic of the X2 pin interface. To enable the integrated LO frequency doubler,

the X2 voltage must be higher than 1.2V. The X2 voltage at the pin should never exceed  $V_{CC}$  by more than 0.3V. If this should occur, the supply current could be sourced through the ESD diode, potentially damaging the IC. If the X2 pin is left floating, its voltage will be pulled low by the internal pull-down resistor and the LO frequency doubler will be disabled.

### Supply Voltage Ramping

Fast ramping of the supply voltage can cause a current glitch in the internal ESD protection circuits. Depending on the supply inductance, this could result in a supply voltage transient that exceeds the maximum rating. A supply voltage ramp time of greater than 1ms is recommended.

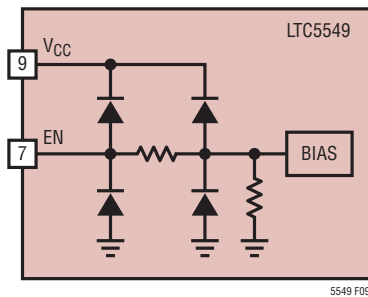

Figure 9. Simplified Enable Input Circuit

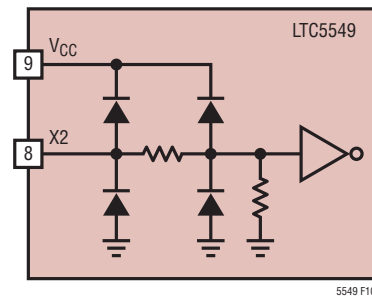

Figure 10. Simplified X2 Interface Circuit



## TYPICAL APPLICATION

Due to the wideband nature of the RF, LO and IF ports, the LTC5549 may be used as an upmixer even when the lower (IF) input frequency is applied to the RF port and the higher (RF) output is taken from the IF port. Operation

in this manner only requires that the input and output frequencies are within the specified frequency ranges. One example is shown in Figure 11, where the RF input ranges from 1.6GHz to 4.5GHz and the IF output is 5.2GHz.

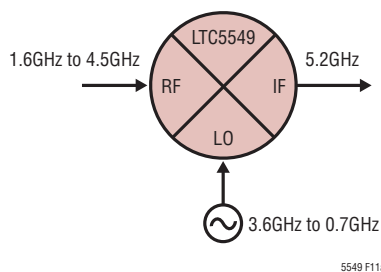

(a) Application Configuration

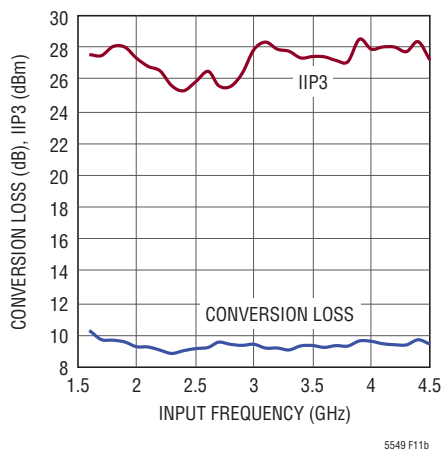

(b) Conversion Loss and IIP3 vs Input Frequency  
(Low Side LO, Output = 5.2GHz)

Figure 11. An Upmixer Application with Input at the RF Port and Output at the IF Port

# PACKAGE DESCRIPTION

Please refer to <http://www.linear.com/designtools/packaging/> for the most recent package drawings.

**UDB Package  
Variation A  
12-Lead Plastic QFN (3mm × 2mm)**  
(Reference LTC DWG # 05-08-1985 Rev 0)

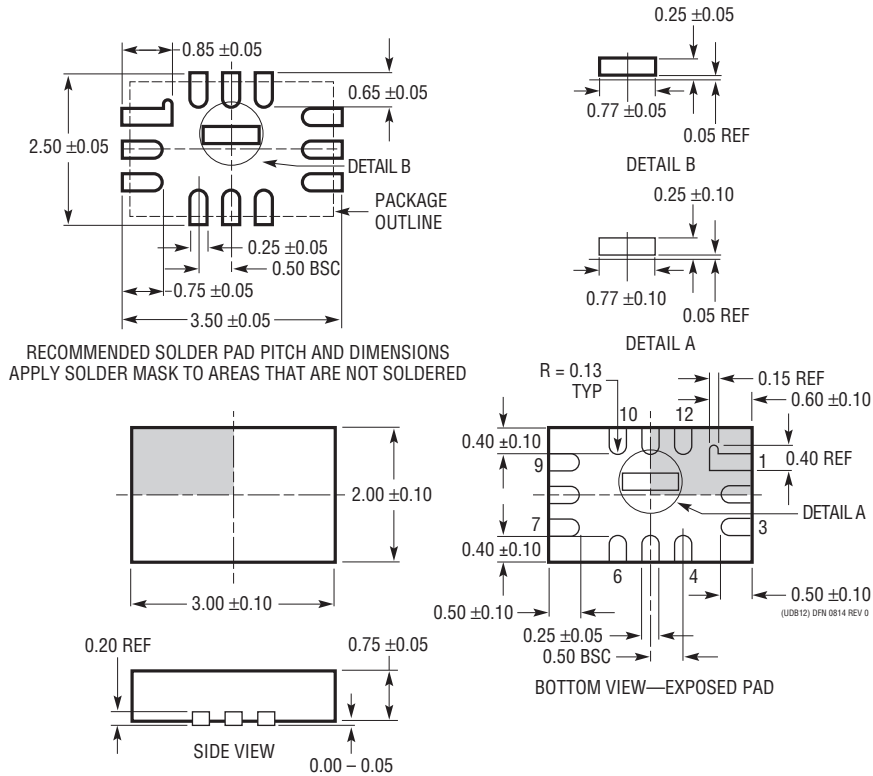

- NOTE:
1. DRAWING IS NOT A JEDEC PACKAGE OUTLINE
  2. DRAWING NOT TO SCALE
  3. ALL DIMENSIONS ARE IN MILLIMETERS
  4. DIMENSIONS OF EXPOSED PAD ON BOTTOM OF PACKAGE DO NOT INCLUDE MOLD FLASH. MOLD FLASH, IF PRESENT, SHALL NOT EXCEED 0.15mm ON ANY SIDE
  5. EXPOSED PAD SHALL BE SOLDER PLATED
  6. SHADED AREA IS ONLY A REFERENCE FOR PIN 1 LOCATION ON THE TOP AND BOTTOM OF PACKAGE

---

**REVISION HISTORY**

| REV | DATE | DESCRIPTION                   | PAGE NUMBER |
|-----|------|-------------------------------|-------------|
| A   | 9/15 | Order part number correction. | 2           |

## TYPICAL APPLICATION

### 5GHz to 14GHz Downconversion

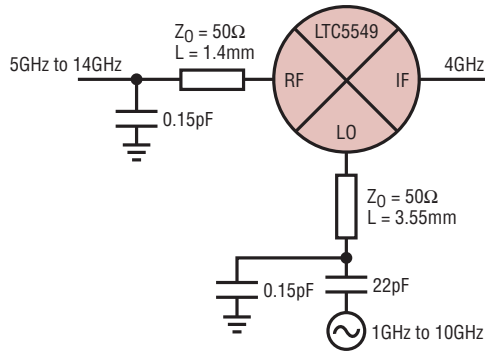

5549 TA02a

### Conversion Loss and IIP3 vs Input Frequency (Low Side LO, IF = 4GHz)

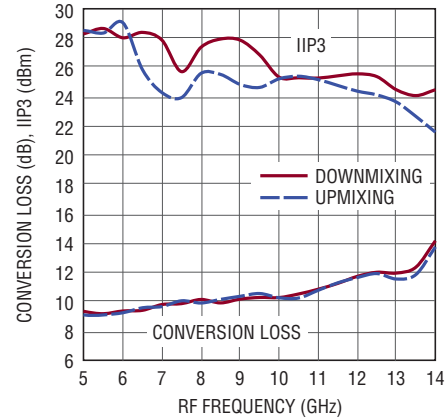

5549 TA02b

## RELATED PARTS

| PART NUMBER                        | DESCRIPTION  | COMMENTS  |
|------------------------------------|--|---|
| <b>Mixers and Modulators</b>       |  |   |
| LTC5551                            | 300MHz to 3.5GHz Ultrahigh Dynamic Range Downconverting Mixer  | +36dBm IIP3; 2.4dB Gain, <10dB NF, 0dBm LO Drive, +18dBm P1dB, 670mW Power Consumption              |
| LTC5567                            | 400MHz to 4GHz, Active Downconverting Mixer                    | 1.9dB Gain, 26.9dBm IIP3 and 11.8dB NF at 1950MHz, 3.3V/89mA Supply                                 |
| LTC5577                            | 300MHz to 6GHz High Signal Level Active Downconverting Mixer   | 50Ω Matched Input from 1.3GHz to 4.3GHz, 30dBm IIP3, 0dB Gain, >40dB LO-RF Isolation, 0dBm LO Drive |
| LTC5510                            | 1MHz to 6GHz Wideband High Linearity Active Mixer              | 50Ω Matched Input from 30MHz to 6GHz, 27dBm OIP3, 1.5dB Gain, Up- or Down-Conversion                |
| LTC5544                            | 4GHz to 6GHz Downconverting Mixer                              | 7.5dB Gain, >25dBm IIP3 and 10dB NF, 3.3V/200mA Supply  |
| LT5578                             | 400MHz to 2.7GHz Upconverting Mixer                            | 27dBm OIP3 at 900MHz, 24.2dBm at 1.95GHz, Integrated RF Output Transformer                          |
| LT5579                             | 1.5GHz to 3.8GHz Upconverting Mixer                            | 27.3dBm OIP3 at 2.14GHz, NF = 9.9dB, 3.3V Supply, Single-Ended LO and RF Ports                      |
| LTC5576                            | 3GHz to 8GHz High Linearity Active Upconverting Mixer          | 25dBm OIP3, -0.6dB Gain, 14.1dB NF, -154dBm/Hz Output Noise Floor, -28dBm LO Leakage at 8GHz        |
| <b>Amplifiers</b>                  |  |   |
| LTC6430-20                         | High Linearity Differential IF Amp                             | 20MHz to 2GHz Bandwidth, 20.8dB Gain, 51dBm OIP3, 2.9dB NF at 240MHz                                |
| LTC6431-20                         | High Linearity Single-Ended IF Amp                             | 20MHz to 1.4GHz Bandwidth, 20.8dB Gain, 46.2dBm OIP3, 2.6dB NF at 240MHz                            |
| <b>RF Power Detectors</b>          |  |   |
| LTC5564                            | 15GHz Ultra Fast 7ns Response Time RF Detector with Comparator | 600MHz to 15GHz, -24dB to 16dBm Input Power Range, 9ns Comparator Response Time, 125°C Version      |
| LT5581                             | 6GHz Low Power RMS Detector                                    | 40dB Dynamic Range, ±1dB Accuracy Over Temperature, 1.5mA Supply Current                            |
| LTC5582                            | 40MHz to 10GHz RMS Detector                                    | ±0.5dB Accuracy Over Temperature, ±0.2dB Linearity Error, 57dB Dynamic Range                        |
| LTC5583                            | Dual 6GHz RMS Power Detector                                   | Up to 60dB Dynamic Range, ±0.5dB Accuracy Over Temperature, >50dB Isolation                         |
| <b>RF PLL/Synthesizer with VCO</b> |  |   |
| LTC6948                            | Ultralow Noise, Low Spurious Frac-N PLL with Integrated VCO    | 373MHz to 6.39GHz, -157dBc/Hz WB Phase Noise Floor, -274dBc/Hz Normalized In-Band 1/f Noise         |

Компания «Life Electronics» занимается поставками электронных компонентов импортного и отечественного производства от производителей и со складов крупных дистрибьюторов Европы, Америки и Азии.

С конца 2013 года компания активно расширяет линейку поставок компонентов по направлению коаксиальный кабель, кварцевые генераторы и конденсаторы (керамические, пленочные, электролитические), за счёт заключения дистрибьюторских договоров

Мы предлагаем:

- Конкурентоспособные цены и скидки постоянным клиентам.
- Специальные условия для постоянных клиентов.
- Подбор аналогов.
- Поставку компонентов в любых объемах, удовлетворяющих вашим потребностям.
- Приемлемые сроки поставки, возможна ускоренная поставка.
- Доставку товара в любую точку России и стран СНГ.
- Комплексную поставку.
- Работу по проектам и поставку образцов.
- Формирование склада под заказчика.
- Сертификаты соответствия на поставляемую продукцию (по желанию клиента).
- Тестирование поставляемой продукции.
- Поставку компонентов, требующих военную и космическую приемку.
- Входной контроль качества.
- Наличие сертификата ISO.

В составе нашей компании организован Конструкторский отдел, призванный помогать разработчикам, и инженерам.

Конструкторский отдел помогает осуществить:

- Регистрацию проекта у производителя компонентов.
- Техническую поддержку проекта.
- Защиту от снятия компонента с производства.
- Оценку стоимости проекта по компонентам.
- Изготовление тестовой платы монтаж и пусконаладочные работы.



Тел: +7 (812) 336 43 04 (многоканальный)  
Email: [org@lifeelectronics.ru](mailto:org@lifeelectronics.ru)